



Energy, Mines and
Resources Canada

Énergie, Mines et
Ressources Canada

Z
258
c3
G8
1987
m

GUIDE DE COULEURS

publié par:

Division de la Reproduction
et de la Distribution
Direction des levés et de la cartographie

COLOUR GUIDE

published by:

Reproduction and Distribution Division
Surveys and Mapping Branch



TROISIÈME ÉDITION
THIRD EDITION
1987

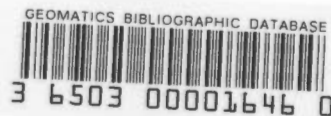

This document was produced
by scanning the original publication.

Ce document est le produit d'une
numérisation par balayage
de la publication originale.

© Minister of Supply and Services Canada 1987

Catalogue No. M52-63/1987

ISBN-0-662-54964-3

Stock No. SMP-1288B

© Ministre des Approvisionnements et Services Canada 1987

N° de catalogue M52-63/1987

ISBN-0-662-54964-3

N° de stock SMP-1288B

TABLE OF CONTENTS

ACKNOWLEDGEMENTS

INTRODUCTION

INDEX OF AVAILABLE COLOURS

SECTION 1:

Colour plates

SECTION 2:

Colour progressions charts

ANNEX 1:

Technical data

ANNEX 2:

Printing specification

TABLE DES MATIÈRES

REMERCIEMENTS

INTRODUCTION

INDEX DES TEINTES DISPONIBLES

SECTION 1:

Clichés de couleurs

SECTION 2:

Gammes progressives de couleurs

ANNEXE 1:

Information technique

ANNEXE 2:

Spécifications d'imprimerie

ACKNOWLEDGEMENTS

I would like to take this opportunity to thank all our colleagues working in the field of cartography who kindly provided us with their comments and ideas for the publication of the third edition of the Colour Guide.

As well, allow me to compliment the employees of the Reproduction and Distribution Division whose efforts and expertise contributed greatly to the success of this project.

As any work related to an evolving field such as cartographic reproduction, this Colour Guide will become a valuable tool and will undoubtedly be improved by suggestions from present and future users.

REMERCIEMENTS

Je profite de l'occasion pour remercier tous nos collègues, oeuvrant dans le domaine de la cartographie, qui ont bien voulu nous faire part de leurs remarques et réflexions lors de la préparation de la troisième édition du Guide des couleurs.

Permettez-moi également de féliciter les employés de la Division de la reproduction et de la distribution dont les efforts et l'expertise ont grandement contribué au succès de ce projet.

Comme tout ouvrage touchant un domaine en constante évolution telle la reproduction cartographique, ce guide deviendra un précieux outil de travail et sera amélioré suite aux suggestions des utilisateurs actuels et futurs.



Jean-Paul Raymond
Director/Directeur
Reproduction and Distribution Division
Division de la reproduction et de la distribution

This Colour Standardization Guide is issued to provide a listing of standard colours used in lithographic offset printing of maps and charts by the Reproduction and Distribution Division. Each colour plate represents the absolute quality intended but does not provide control limits. Tolerances are established separately with a quality control program and are product dependent.

STANDARD COLOURS

The colours in this standardization guide are derived from eight basic Pantone colours plus black and white. Included in the technical information sheet is the Pantone Formula. It is important to note that these colours have been matched to existing colours, using the Pantone basic colours, as specified by the map designer and will not match the Pantone Formula Guide. A detailed description of the technical information sheet is provided in Annex 1.

COLOUR IDENTIFICATION NUMBER

The first print of each colour of the standardization guide uses the old three digit colour numbers. The next printing will use a colour identification number composed of seven digits: the first four represent the dominant wavelength and the last three the existing colour number. This transitional period will lead up to an ink catalogue system based on the dominant wavelength of the ink (four digit number) which will not allow two inks to have the same colour number and the addition of new colours will be in a logical sequence.

On a publié ce guide de normalisation des couleurs standard employées dans l'impression lithographique offset de cartes par la Division de la reproduction et de la distribution. Chaque planche de couleur représente la qualité absolue désirée, mais ne garantit pas des limites de contrôle. On établit séparément les tolérances avec un programme de contrôle de qualité ; celle-ci dépend du produit.

COULEURS STANDARD

Les couleurs indiquées dans ce guide de normalisation sont dérivées des huit couleurs de base du système Pantone, plus le noir et le blanc. La formule Pantone est incluse dans la fiche d'information technique. Il est important de noter que ces couleurs ont été assorties aux couleurs existantes, à partir des couleurs de base en conformité avec les spécifications du cartographe, et ne seront pas assorties au Guide de formule des couleurs Pantone. On présente à l'Annexe 1 une description détaillée des fiches techniques d'information.

NUMÉRO D'IDENTIFICATION DES COULEURS

On s'est servi de l'ancienne numérotation à trois chiffres pour le premier tirage de chacune des couleurs du guide de normalisation. On utilisera, pour le prochain tirage, un numéro composé de sept chiffres : les quatre premiers correspondront à la longueur d'onde dominante et les trois derniers au numéro existant de couleur. Cette période de transition débouchera sur un système de catalogage des couleurs basé exclusivement sur la longueur d'onde dominante de l'encre (nombre à quatre chiffres) et aucune couleur ne portera le même numéro qu'une autre. Les nouvelles couleurs seront ajoutées selon une séquence logique.

COLOUR PLATE SEQUENCE

The colours in this standardization guide are arranged under the following categories:

- The chromatic colours are listed by the dominant wavelength in the spectrum progressing from colours with a blue dominant wavelength through to those with a red dominant wavelength.
- The non-spectral colours, such as the purples, are designated by the complementary wavelength. The colour number is prefixed with a “C”.
- The earth colours such as brown and beige are designated by a colour number prefixed with a “M”.
- The final category is the achromatic series from gray through black prefixed with the letter “A”.
- The process colours, their combinations and progressions are grouped in a separate section.

COLOUR LIGHTING AND VIEWING

The Reproduction and Distribution Division has adopted the American Standards Institute 5,000° Kelvin and a colour rendering index of 90. Munsell M/8 grey swatches or equivalent are utilized as a surround.

SÉQUENCE DE LA PLANCHE DE COULEUR

Les couleurs figurant dans ce guide de normalisation sont classées dans les catégories suivantes :

- Les couleurs chromatiques sont indiquées suivant la longueur d’onde dominante dans le spectre, en allant d’une couleur à longueur d’onde correspondant au bleu, aux couleurs à dominante rouge.
- Les couleurs non spectrales comme les pourpres sont désignées par la longueur d’onde complémentaire. Le numéro de couleur est précédé de la lettre “C”.
- Les couleurs de terre comme les bruns et beiges sont désignées par un numéro de couleur précédé de la lettre “M”.
- La catégorie finale est la série achromatique allant du gris au noir, précédé de la lettre “A”.
- Les couleurs quadrichromiques individuelles, leurs combinaisons et leurs progressions sont groupées dans une section séparée.

ÉCLAIRAGE ET OBSERVATION DES COULEURS

La Division de la reproduction et de la distribution a adopté les normes de l’American Standards Institute, soit 5,000° Kelvin et un indice de rendu des couleurs de 90. On a utilisé des coupons d’échantillon de gris M/8 du système Munsell ou l’équivalent comme champ périphérique de comparaison.

NEW INKS

The introduction of new inks, which may be required from time to time by the map designer, will be requested through normal correspondence to the Reproduction and Distribution Division. Accompanied with the formal request will be a sample colour patch of the ink requested. A complete investigation will commence prior to acceptance and inclusion into the Colour Standardization Guide.

The investigation will consist of:

- Colour matching using the Pantone formula by an ink manufacturer.
- Assessment of ink/paper printability in a normal reproduction mode.
- A written approval and acceptance of the resulting colour by the map designer will be required prior to the distribution of the particular ink.

Due to the large quantity of spot colours in existence presently (53 available inks), we recommend careful consideration be given, such as, yearly ink usage, image size coverage and printing quantity to form part of your criterias prior to the introduction of a new ink.

By avoiding increases in spot colour inks, it will benefit all concerned in maintaining consistency, repetition and high quality of our printed products.

NOUVELLES ENCRE

Le cartographe qui pourrait avoir besoin de nouvelles encres devra adresser sa demande au personnel compétent de la Division de la reproduction et de la distribution et joindre à cette demande un échantillon de la couleur de l'encre demandée. On effectuera alors une étude exhaustive avant de l'accepter et de l'inclure au guide de normalisation des couleurs.

On procédera à l'étude de la façon suivante:

- Un manufacturier d'encre assortira la couleur à partir de la formule Pantone.
- On évaluera la qualité de l'impression de l'encre sur le papier dans des conditions normales de reproduction.
- On exigera une approbation écrite et l'acceptation de la couleur résultante, par le cartographe, avant de distribuer ladite encre.

Vu le nombre important de couleurs spéciales qui existe déjà (53 encres disponibles), nous recommandons qu'une attention particulière soit accordée aux éléments suivants, soit la consommation annuelle de l'encre, la dimension de l'image à couvrir et la quantité d'impressions et qu'on tienne compte de ces critères avant d'adopter une nouvelle encre.

En évitant d'augmenter les couleurs spéciales d'encre, toutes les parties concernées profiteront du maintien de l'invariabilité, de la répétition et de la qualité supérieure de nos produits d'impression.

INDEX OF AVAILABLE
COLOURS AND TINTS

INDEX DES TEINTES ET
COULEURS DISPONIBLES

N.T.S. MAP COLOURS

New Colour No. Nouveau No. Couleur	Name/Nom	Old Colour No. Ancien No. Couleur
M-5832	Beige Mountain	464
A-0101	Black Map	101
4670	Blue Aero	119
4950	Blue Chart	114
4821	Blue Display	115
4770	Blue Drainage	112
4810	Blue Shade	301
4823	Blue Jog	4841
A-5040	Blue Park Gray	117
4780	Blue Ultramarine	113
4930	Blue Water	110
4910	Blue Transparent	118
M-5950	Brown Chestnut	133
M-5860	Brown Contour	130
M-5760	Brown Jog	5823
M-5770	Brown Jog Old	5834
M-5813	Brown Transparent	131
M-5751	Buff Chart	136
M-5811	Buff First	137
M-5752	Buff Jog	2405
M-5831	Buff Second	139
M-5812	Buff Third	138
5970	Carmine Chart	126
4822	Cyan Process	111

New Colour No. Nouveau No. Couleur	Name/Nom	Old Colour No. Ancien No. Couleur
5360	Green Falco	141
5680	Green Layer	146
5711	Green Olive	143
5160	Green Pea	144
5640	Green Jog	373
5510	Green Jog	5524
5230	Green Enroute	347
5630	Green Shade	365
A-5642	Grey Chart	109
A-5690	Grey Jog	57003
A-5050	Grey Loran Off. Jog	431
A-4720	Grey Shading	106
A-5700	Grey Transparent	107
C-4970	Magenta Process	125
C-5460	Magenta Chart	127
C-5090	Maroon Map	91021
5880	Orange Opaque	167
5814	Orange Shade	168
C-5550	Purple	415
4200	Purple Map	150
6020	Red Display	122
6110	Red Jog	6120
6290	Red Map	121
6060	Red Transparent	123
5723	Yellow Chart	160
5722	Yellow Jog	2404
5721	Yellow Jog	5727
5732	Yellow Process	165
5731	Yellow Townstamp	162

CHROMATIC COLOURS - COULEURS CHROMATIQUES

Colour No. Couleur	Name/Nom
4200 (150)	Purple Map
4670 (119)	Blue Aero
4770 (112)	Blue Drainage
4780 (113)	Blue Ultramarine
4810 (301)	Blue Shade
4821 (115)	Blue Display
4823 (4841)	Blue Jog
4910 (118)	Blue Transparent
4930 (110)	Blue Water
4950 (114)	Blue Chart
5160 (144)	Green Pea
5230 (347)	Green Enroute
5360 (141)	Green Falco
5510 (5524)	Green Jog
5630 (365)	Green Shade
5640 (373)	Green Jog
5680 (146)	Green Layer
5711 (143)	Green Olive
5721 (5727)	Yellow Jog
5722 (2404)	Yellow Jog
5723 (160)	Yellow Chart
5731 (162)	Yellow Townstamp
5814 (168)	Orange Shade
5880 (167)	Orange Opaque
5970 (126)	Carmine Chart
6020 (122)	Red Display
6060 (123)	Red Transparent
6110 (6120)	Red Jog
6290 (121)	Red Map

PURPLE OVERPRINT.

VIGNETTES

WOODEN AREAS.

RED ROADS.

130

BROWN.

TECHNICAL INFORMATION — DONNÉES TECHNIQUES

INK - ENCRE

PANTONE® * FORMUL (A/E)

COLOUR No. COULEUR : 4200-150

— .8200 parts Pantone Purple
— .1800 parts Pantone Reflex Blue

AIM SOLID DENSITY
DENSITÉ TEINTE PLATE VISÉE : 0.87 W/H 0.81 D/S

GRAYNESS - NETTETÉ : N/A

HUE ERROR - DÉVIATION DE : N/A
TEINTE

INK EFFICIENCY
EFFICACITÉ DE L'ENCRE : N/A

DENSITOMETRY / DENSITOMÉTRIE

• CHANNEL-SÉLECTION: MAGENTA

• FILTER TYPE DE FILTRES: STATUS T

• FACTEUR n FACTOR: 2.7

* Pantone, Inc.'s check-standard trademark for colour reproduction and colour reproduction materials.
* La marque de Pantone, Inc. de contrôle uniforme pour la reproduction en couleur et les matériaux pour la reproduction en couleur.

CIE CHROMATICITY DIAGRAM(ME) DES CHROMATICITÉS CIE

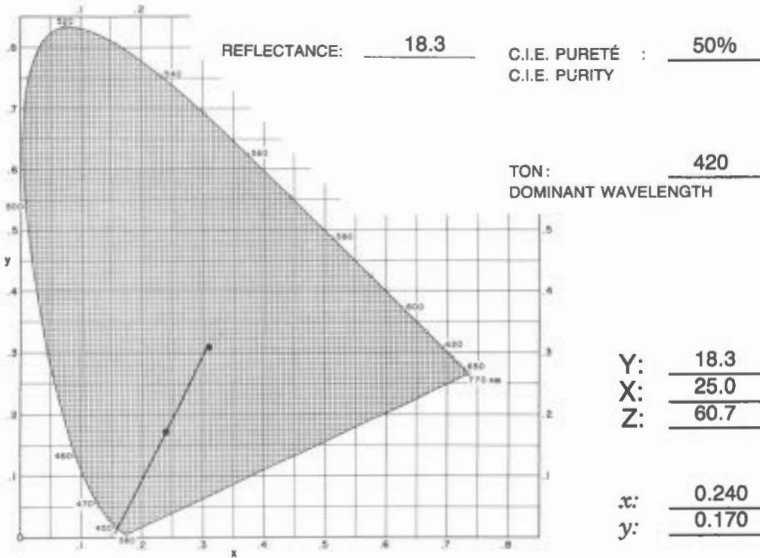

PAPER - PAPIER

PLATE - PLAQUE

GRADE / CATÉGORIE: W.S. STANDARD

SUBT. - SOUST.

TYPE: UNCOATED - NON COUCHÉ

TYPE: NEGATIVE

REFLECTIVITÉ / REFLECTIVITY: 85%

PRESS - PRESSE

OPACITÉ / OPACITY: 87%

• MEIHLE

% CONTRASTE/CONTRAST: 20%

• UNIT(É) #: LOWER/INFÉRIEURE

ID. PATCHES BLOCS IDEN.	% SCREEN TRAME	DENSITY DENSITÉ	% PRINT IMPRESSION
A	3	.11	7
B	6	.13	12
C	12	.18	19
D	22	.23	30
E	30	.31	40
F	40	.39	51
G	52	.49	64
H	66	.60	77
I	77	.67	87
J	87	.73	93
M	14	.22	26
N	27	.32	42
O	37	.38	49
P	51	.46	62
SOLID TEINTE PLATE	100	.84	100

The colour printed here was blended from, and should only be blended from PANTONE Basic Colours obtained from a PANTONE Licensed Printing Ink Manufacturer. Pantone, Inc. assumes no responsibility for the accuracy of the formulas or the colour reproduced.

La couleur ci-imprimée fut et devrait être mélangée seulement à partir des couleurs de base PANTONE obtenues d'un fabricant d'encre autorisé. La compagnie Pantone, Inc. n'assume aucune responsabilité quant à l'exactitude du mélange ou de la couleur obtenue.

RDD - DRD

COLOURS AND SCREENS

COULEURS ET TRAMES

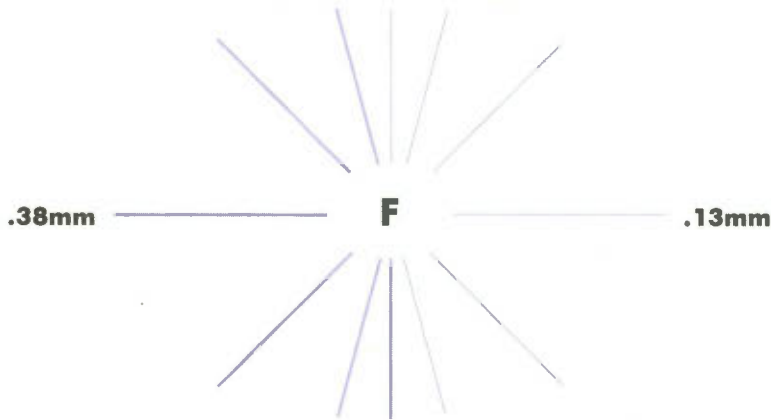

BIANGULAR SCREENS — TRAMES BIANGULÉES

M

6 pt. Century Text Italic/Italique
8 pt. Triumvirate Roman/Romain
10 pt. Futura Roman/Romain
12 pt. CG Trade Condensed/Condensé



N

6 pt. Triumvirate Roman/Romain
8 pt. Futura Roman/Romain
10 pt. CG Trade Condensed/Condensé
12 pt. Cent. Text It./Italique



O

6 pt. Futura Roman/Romain
8 pt. CG Trade Condensed/Condensé
10 pt. Century Text Italic/Italique
12 pt. Trium. Rom./Romain



P

6 pt. CG Trade Condensed/Condensé
8 pt. Century Text Italic/Italique
10 pt. Triumvirate Roman/Romain
12 pt. Futura Roman/Romain



SOLID — TEINTE PLATE

6 pt. Century Text Italic/Italique
8 pt. Triumvirate Roman/Romain
10 pt. Futura Roman/Romain
12 pt. CG Trade Condensed/Condensé



A

B

C

D

E

F

G

H

I

J

S

TECHNICAL INFORMATION — DONNÉES TECHNIQUES

INK - ENCRE

PANTONE® * FORMUL (A/E)

COLOUR No. COULEUR : 4200-150

— .8200 parts Pantone Purple
— .1800 parts Pantone Reflex Blue

AIM SOLID DENSITY
DENSITÉ TEINTE PLATE VISÉE : 0.89 W/H 0.84 D/S

GRAYNESS - NETTETÉ : N/A

HUE ERROR - DÉVIATION DE : N/A
TEINTE

INK EFFICIENCY : N/A
EFFICACITÉ DE L'ENCRE

DENSITOMETRY / DENSITOMÉTRIE

- CHANNEL-SÉLECTION: MAGENTA
- FILTER TYPE DE FILTRES: STATUS T
- FACTEUR n FACTOR: 2.7

* Pantone, Inc.'s check-standard trademark for colour reproduction and colour reproduction materials.
* La marque de Pantone, Inc. de contrôle uniforme pour la reproduction en couleur et les matériaux pour la reproduction en couleur.

CIE CHROMATICITY DIAGRAM(ME) DES CHROMATICITÉS CIE

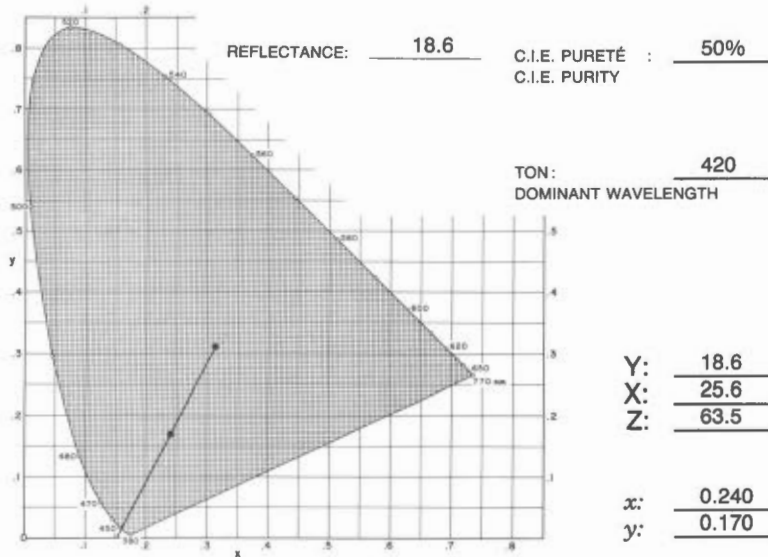

ID. PATCHES BLOCS IDEN.	% SCREEN TRAME	DENSITY DENSITÉ	% PRINT IMPRESSION
A	3	.10	7
B	6	.12	10
C	12	.18	20
D	22	.23	28
E	30	.30	38
F	40	.38	51
G	52	.47	63
H	66	.55	76
I	77	.65	87
J	87	.68	92
M	14	.21	27
N	27	.31	42
O	37	.37	51
P	51	.45	68
SOLID TEINTE PLATE	100	.77	100

PAPER - PAPIER

GRADE / CATÉGORIE: W.S. NEW BRITE

TYPE: UNCOATED - NON COUCHÉ

REFLECTIVITÉ / REFLECTIVITY: 85%

OPACITÉ / OPACITY: 85.5%

% CONTRASTE/CONTRAST: 16%

PLATE - PLAQUE

SUBT. - SOUST. TYPE: NEGATIVE

PRESS - PRESSE

• MEIHLE

• UNIT(É) #: LOWER/INFÉRIEURE

The colour printed here was blended from, and should only be blended from PANTONE Basic Colours obtained from a PANTONE Licensed Printing Ink Manufacturer.
Pantone, Inc. assumes no responsibility for the accuracy of the formulas or the colour reproduced.

La couleur ci-imprimée fut et devrait être mélangée seulement à partir des couleurs de base PANTONE obtenues d'un fabricant d'encre autorisé.
La compagnie Pantone, Inc. n'assume aucune responsabilité quant à l'exactitude du mélange ou de la couleur obtenue.

TECHNICAL INFORMATION — DONNÉES TECHNIQUES

INK - ENCRE

PANTONE® * FORMUL (A/E)

COLOUR No. COULEUR : 4200-150

— .8200 parts Pantone Purple
— .1800 parts Pantone Reflex Blue

AIM SOLID DENSITY
DENSITÉ TEINTE PLATE VISÉE : 0.88 W/H 0.82 D/S

GRAYNESS - NETTETÉ : N/A

HUE ERROR - DÉVIATION DE : N/A
TEINTE

INK EFFICIENCY : N/A
EFFICACITÉ DE L'ENCRE

DENSITOMETRY / DENSITOMÉTRIE

- CHANNEL-SÉLECTION: MAGENTA
- FILTER TYPE DE FILTRES: STATUS T
- FACTEUR n FACTOR: 2.7

* Pantone, Inc.'s check-standard trademark for colour reproduction and colour reproduction materials.
* La marque de Pantone, Inc. de contrôle uniforme pour la reproduction en couleur et les matériaux pour la reproduction en couleur.

CIE CHROMATICITY DIAGRAM(ME) DES CHROMATICITÉS CIE

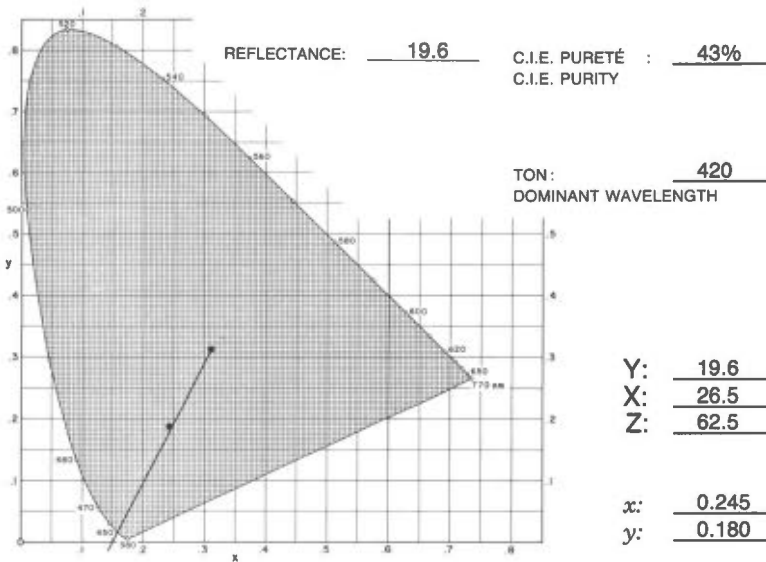

ID. PATCHES BLOCS IDEN.	% SCREEN FRAME	DENSITY DENSITÉ	% PRINT IMPRESSION
A	3	.09	8
B	6	.11	11
C	12	.15	17
D	22	.21	27
E	30	.28	37
F	40	.35	48
G	52	.44	60
H	66	.55	74
I	77	.63	84
J	87	.72	91
M	14	.19	23
N	27	.29	40
O	37	.34	46
P	51	.43	59
SOLID TEINTE PLATE	100	.82	100

PAPER - PAPIER

GRADE / CATÉGORIE: CHART

TYPE: UNCOATED - NON COUCHÉ

REFLECTIVITÉ / REFLECTIVITY: 87%

OPACITÉ / OPACITY: 96.5%

% CONTRASTE/CONTRAST: 23%

PLATE - PLAQUE

SUBT. - SOUST.

TYPE: NEGATIVE

PRESS - PRESSE

• MEIHLE

• UNIT(É) #: LOWER/INFÉRIEURE

The colour printed here was blended from, and should only be blended from PANTONE Basic Colours obtained from a PANTONE Licensed Printing Ink Manufacturer.
Pantone, Inc. assumes no responsibility for the accuracy of the formulas or the colour reproduced.

La couleur ci-imprimée fut et devrait être mélangée seulement à partir des couleurs de base PANTONE obtenues d'un fabricant d'encre autorisé.
La compagnie Pantone, Inc. n'assume aucune responsabilité quant à l'exactitude du mélange ou de la couleur obtenue.

RDD - DRD

COLOURS AND SCREENS

COULEURS ET TRAMES



BIANGULAR SCREENS — TRAMES BIANGULÉES

M

	.08mm	
	.13mm	
	.18mm	
	.25mm	
	.38mm	

N

4 pt. Triumvirate Roman/Romain	.08mm	
8 pt. Futura Roman/Romain	.13mm	
10 pt. CG Trade Condensed/Condensé	.18mm	
12 pt. Cent. Text It./Italique	.25mm	
	.38mm	

O

6 pt. Futura Roman/Romain	.08mm	
8 pt. CG Trade Condensed/Condensé	.13mm	
10 pt. Century Text It./Italique	.18mm	
12 pt. Trium. Rom./Romain	.25mm	
	.38mm	

P

6 pt. CG Trade Condensed/Condensé	.08mm	
8 pt. Century Text It./Italique	.13mm	
10 pt. Triumvirate Roman/Romain	.18mm	
12 pt. Futura Roman/Romain	.25mm	
	.38mm	

SOLID — TEINTE PLATE

6 pt. Century Text It./Italique	.08mm	
8 pt. Triumvirate Roman/Romain	.13mm	
10 pt. Futura Roman/Romain	.18mm	
12 pt. CG Trade Condensed/Condensé	.25mm	
	.38mm	

A

B

C

D

E

F

G

H

I

J

S

TECHNICAL INFORMATION — DONNÉES TECHNIQUES

INK - ENCRE

PANTONE® * FORMUL (A/E)

COLOUR No. COULEUR : 4670-119

- .3140 parts Pantone Reflex Blue
- .3330 parts Pantone Rubine Red
- .3530 parts Pantone Extender
-

AIM SOLID DENSITY
DENSITÉ TEINTE PLATE VISÉE : 0.88 W/H 0.81 D/S

GRAYNESS - NETTETÉ : N/A

HUE ERROR - DÉVIATION DE : N/A
TEINTE

INK EFFICIENCY : N/A
EFFICACITÉ DE L'ENCRE

DENSITOMETRY / DENSITOMÉTRIE

- CHANNEL-SÉLECTION: VISUAL
- FILTER TYPE DE FILTRES: STATUS T
- FACTEUR n FACTOR: 2.7

* Pantone, Inc.'s check-standard trademark for colour reproduction and colour reproduction materials.

* La marque de Pantone, Inc. de contrôle uniforme pour la reproduction en couleur et les matériaux pour la reproduction en couleur.

CIE CHROMATICITY DIAGRAM(ME) DES CHROMATICITÉS CIE

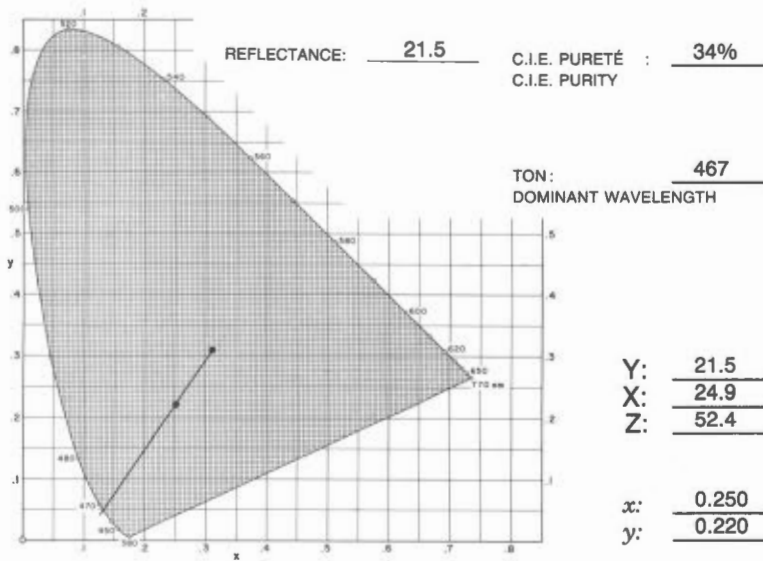

PAPER - PAPIER

PLATE - PLAQUE

GRADE / CATÉGORIE: W.S. STANDARD

SUBT. - SOUST.

TYPE: UNCOATED - NON COUCHÉ

TYPE: NEGATIVE

REFLECTIVITÉ / REFLECTIVITY: 89%

PRESS - PRESSE

OPACITÉ / OPACITY: 87%

• MEIHLE

% CONTRASTE/CONTRAST: 10%

• UNIT(É) #: LOWER/INFÉRIEURE

ID. PATCHES BLOCS IDEN.	% SCREEN TRAME	DENSITY DENSITÉ	% PRINT IMPRESSION
A	3	.08	6
B	6	.11	12
C	12	.16	19
D	22	.24	32
E	30	.31	44
F	40	.41	59
G	52	.50	74
H	66	.59	85
I	77	.65	95
J	87	.67	96
M	14	.20	28
N	27	.32	48
O	37	.37	57
P	51	.46	58
SOLID TEINTE PLATE	100	.72	100

The colour printed here was blended from, and should only be blended from PANTONE Basic Colours obtained from a PANTONE Licensed Printing Ink Manufacturer. Pantone, Inc. assumes no responsibility for the accuracy of the formulas or the colour reproduced.

La couleur ci-imprimée fut et devrait être mélangée seulement à partir des couleurs de base PANTONE obtenues d'un fabricant d'encre autorisé. La compagnie Pantone, Inc. n'assume aucune responsabilité quant à l'exactitude du mélange ou de la couleur obtenue.

RDD - DRD

COLOURS AND SCREENS

COULEURS ET TRAMES

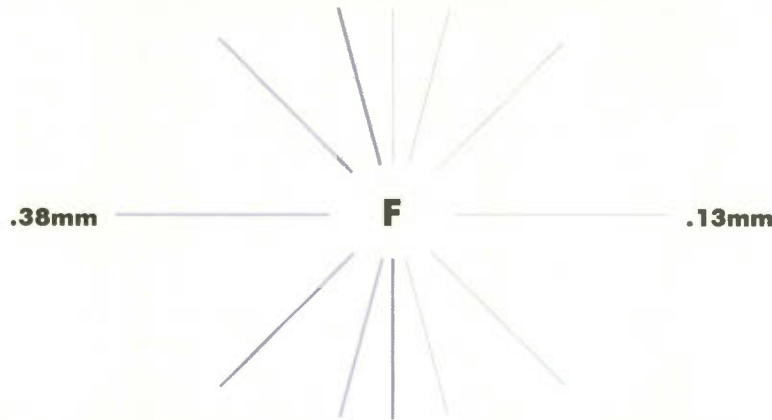

BIANGULAR SCREENS — TRAMES BIANGULÉES

M

6 pt. *Triumvirate Roman/Romain*
8 pt. *Triumvirate Roman/Romain*
10 pt. *Futura Roman/Romain*
12 pt. *CG Trade Condensed/Condensé*



N

6 pt. *Triumvirate Roman/Romain*
8 pt. *Futura Roman/Romain*
10 pt. *CG Trade Condensed/Condensé*
12 pt. *Cent. Text It./Italique*



O

6 pt. *Futura Roman/Romain*
8 pt. *CG Trade Condensed/Condensé*
10 pt. *Century Text Italic/Italique*
12 pt. *Trium. Rom./Romain*



P

6 pt. *CG Trade Condensed/Condensé*
8 pt. *Century Text Italic/Italique*
10 pt. *Triumvirate Roman/Romain*
12 pt. *Futura Roman/Romain*



SOLID — TEINTE PLATE

6 pt. *Century Text Italic/Italique*
8 pt. *Triumvirate Roman/Romain*
10 pt. *Futura Roman/Romain*
12 pt. *CG Trade Condensed/Condensé*



A

B

C

D

E

F

G

H

I

J

S

TECHNICAL INFORMATION — DONNÉES TECHNIQUES

INK - ENCRE

PANTONE® * FORMUL (A/E)

COLOUR No. COULEUR : 4670-119

- .3140 parts Pantone Reflex Blue
- .3330 parts Pantone Rubine Red
- .3530 parts Pantone Extender

AIM SOLID DENSITY
DENSITÉ TEINTE PLATE VISÉE : 0.90 W/H 0.80 D/S

GRAYNESS - NETTETÉ : N/A

HUE ERROR - DÉVIATION DE : N/A
TEINTE

INK EFFICIENCY : N/A
EFFICACITÉ DE L'ENCRE

DENSITOMETRY / DENSITOMÉTRIE

- CHANNEL-SÉLECTION: VISUAL
- FILTER TYPE DE FILTRES: STATUS T
- FACTEUR n FACTOR: 2.7

* Pantone, Inc.'s check-standard trademark for colour reproduction and colour reproduction materials.

* La marque de Pantone, Inc. de contrôle uniforme pour la reproduction en couleur et les matériaux pour la reproduction en couleur.

CIE CHROMATICITY DIAGRAM(ME) DES CHROMATICITÉS CIE

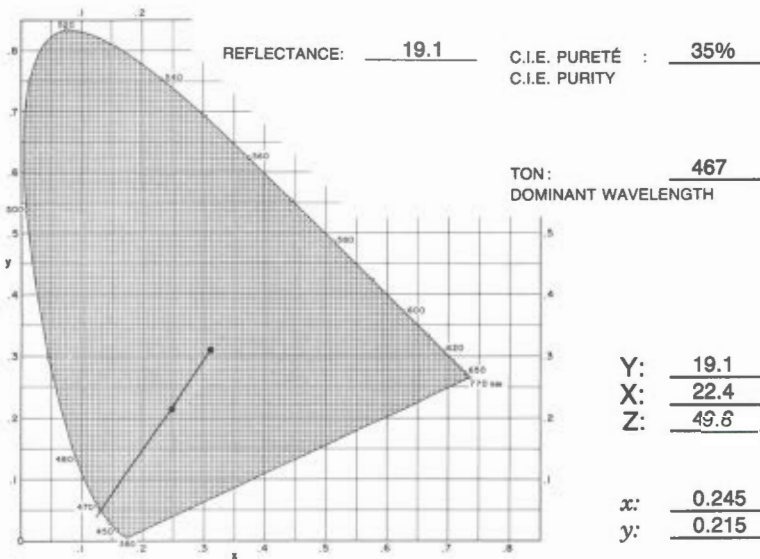

PAPER - PAPIER

PLATE - PLAQUE

GRADE / CATÉGORIE: W.S. NEW BRITE

SUBT. - SOUST.

TYPE: UNCOATED - NON COUCHÉ

TYPE: NEGATIVE

REFLECTIVITÉ / REFLECTIVITY: 87%

PRESS - PRESSE

OPACITÉ / OPACITY: 85.5%

• MEIHLE

% CONTRASTE/CONTRAST: 10%

• UNIT(É) #: LOWER/INFÉRIEURE

ID. PATCHES BLOCS IDEN.	% SCREEN TRAME	DENSITY DENSITE	% PRINT IMPRESSION
A	3	.09	5
B	6	.12	11
C	12	.17	19
D	22	.24	33
E	30	.31	43
F	40	.40	55
G	52	.52	71
H	66	.64	86
I	77	.68	91
J	87	.71	93
M	14	.20	28
N	27	.33	46
O	37	.41	57
P	51	.50	70
SOLID TEINTE PLATE	100	.76	100

The colour printed here was blended from, and should only be blended from PANTONE Basic Colours obtained from a PANTONE Licensed Printing Ink Manufacturer. Pantone, Inc. assumes no responsibility for the accuracy of the formulas or the colour reproduced.

La couleur ci-imprimée fut et devrait être mélangée seulement à partir des couleurs de base PANTONE obtenues d'un manufacturier d'encre autorisé. La compagnie Pantone, Inc. n'assume aucune responsabilité quant à l'exactitude du mélange ou de la couleur obtenue.

RDD - DRD
COLOURS AND SCREENS
COULEURS ET TRAMES

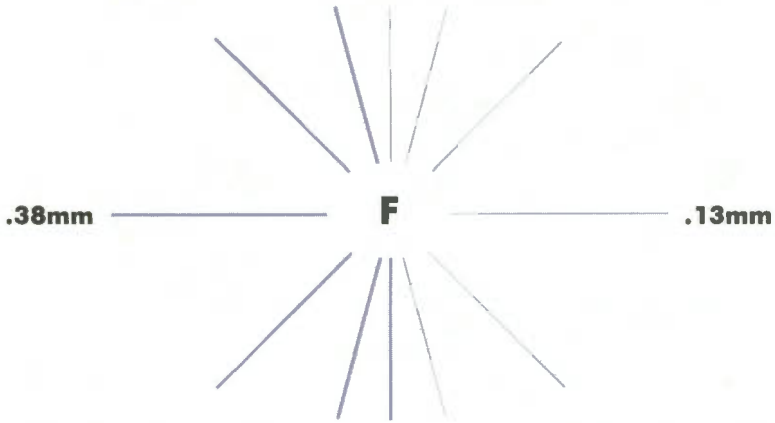

BIANGULAR SCREENS — TRAMES BIANGULÉES

M

10 pt. Century Text Italic/Italique
 8 pt. Triumvirate Roman/Romain
 10 pt. Futura Roman/Romain
 12 pt. CG Trade Condensed/Condensé

.08mm
 .13mm
 .18mm
 .25mm
 .38mm

N

6 pt. Triumvirate Roman/Romain
 8 pt. Futura Roman/Romain
 10 pt. CG Trade Condensed/Condensé
 12 pt. Cent. Text It./Italique

.08mm
 .13mm
 .18mm
 .25mm
 .38mm

O

6 pt. Futura Roman/Romain
 8 pt. CG Trade Condensed/Condensé
 10 pt. Century Text Italic/Italique
 12 pt. Trium. Rom./Romain

.08mm
 .13mm
 .18mm
 .25mm
 .38mm

P

6 pt. CG Trade Condensed/Condensé
 8 pt. Century Text Italic/Italique
 10 pt. Triumvirate Roman/Romain
 12 pt. Futura Roman/Romain

.08mm
 .13mm
 .18mm
 .25mm
 .38mm

SOLID — TEINTE PLATE

6 pt. Century Text Italic/Italique
 8 pt. Triumvirate Roman/Romain
 10 pt. Futura Roman/Romain
 12 pt. CG Trade Condensed/Condensé

.08mm
 .13mm
 .18mm
 .25mm
 .38mm

A
B
C
D
E
F
G
H
I
J
S



TECHNICAL INFORMATION — DONNÉES TECHNIQUES

INK - ENCRE

PANTONE® * FORMUL (A/E)

COLOUR No. COULEUR : 4770-112

- .8300 parts Pantone Process Blue
- .1400 parts Pantone Purple
- .0300 parts Pantone Process Black
-

AIM SOLID DENSITY
DENSITÉ TEINTE PLATE VISÉE : 1.11 W/H 1.03 D/S

GRAYNESS - NETTETÉ : N/A

HUE ERROR - DÉVIATION DE : N/A
TEINTE

INK EFFICIENCY : N/A
EFFICACITÉ DE L'ENCRE

DENSITOMETRY / DENSITOMÉTRIE

- CHANNEL-SÉLECTION: CYAN
- FILTER TYPE DE FILTRES: STATUS T
- FACTEUR n FACTOR: 2.7

* Pantone, Inc.'s check-standard trademark for colour reproduction and colour reproduction materials.

* La marque de Pantone, Inc. de contrôle uniforme pour la reproduction en couleur et les matériaux pour la reproduction en couleur.

CIE CHROMATICITY DIAGRAM(ME) DES CHROMATICITÉS CIE

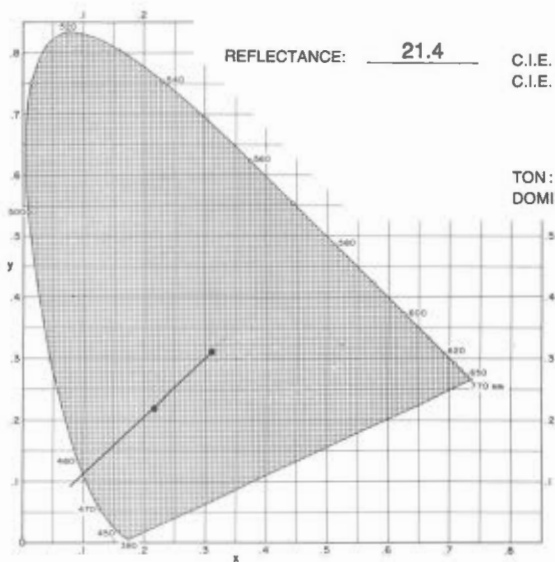

REFLECTANCE: 21.4 C.I.E. PURETÉ : 45%
C.I.E. PURITY

TON: 477
DOMINANT WAVELENGTH

Y: 21.4
X: 20.7
Z: 55.1

x: 0.215
y: 0.220

PAPER - PAPIER

PLATE - PLAQUE

GRADE / CATÉGORIE: W.S. STANDARD

SUBT. - SOUST.

TYPE: UNCOATED - NON COUCHÉ

TYPE: NEGATIVE

REFLECTIVITÉ / REFLECTIVITY: 85%

PRESS - PRESSE

OPACITÉ / OPACITY: 87%

• MEIHLE

% CONTRASTE/CONTRAST: 15%

• UNIT(É) #: LOWER/INFÉRIEURE

ID. PATCHES BLOCS IDEN.	% SCREEN TRAME	DENSITY DENSITÉ	% PRINT IMPRESSION
A	3	.10	7
B	6	.14	12
C	12	.19	20
D	22	.28	31
E	30	.35	41
F	40	.47	52
G	52	.60	68
H	66	.76	80
I	77	.83	90
J	87	.91	93
M	14	.24	25
N	27	.38	43
O	37	.46	55
P	51	.56	64
SOLID TEINTE PLATE	100	.98	100

The colour printed here was blended from, and should only be blended from PANTONE Basic Colours obtained from a PANTONE Licensed Printing Ink Manufacturer. Pantone, Inc. assumes no responsibility for the accuracy of the formulas or the colour reproduced.

La couleur ci-imprimée fut et devrait être mélangée seulement à partir des couleurs de base PANTONE obtenues d'un fabricant d'encre autorisé. La compagnie Pantone, Inc. n'assume aucune responsabilité quant à l'exactitude du mélange ou de la couleur obtenue.

RDD - DRD
COLOURS AND SCREENS
COULEURS ET TRAMES

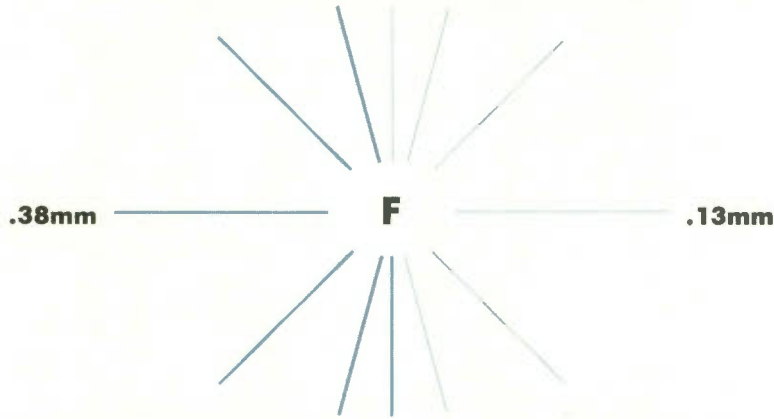

BIANGULAR SCREENS — TRAMES BIANGULÉES

M

6 pt. Century Text Italic/Italique

8 pt. Triumvirate Roman/Romain

10 pt. Futura Roman/Romain

12 pt. CG Trade Condensed/Condensé



N

6 pt. Triumvirate Roman/Romain

8 pt. Futura Roman/Romain

10 pt. CG Trade Condensed/Condensé

12 pt. Cent. Text It./Italique



O

6 pt. Futura Roman/Romain

8 pt. CG Trade Condensed/Condensé

10 pt. Century Text Italic/Italique

12 pt. Trium. Rom./Romain



P

6 pt. CG Trade Condensed/Condensé

8 pt. Century Text Italic/Italique

10 pt. Triumvirate Roman/Romain

12 pt. Futura Roman/Romain



SOLID — TEINTE PLATE

6 pt. Century Text Italic/Italique

8 pt. Triumvirate Roman/Romain

10 pt. Futura Roman/Romain

12 pt. CG Trade Condensed/Condensé



A

B

C

D

E

F

G

H

I

J

S

TECHNICAL INFORMATION — DONNÉES TECHNIQUES

INK - ENCRE

PANTONE® * FORMUL (A)
(E)

COLOUR No. COULEUR : 4770-112

- ___ .8300 parts Pantone Process Blue
- ___ .1400 parts Pantone Purple
- ___ .0300 parts Pantone Process Black
- ___

AIM SOLID DENSITY
DENSITÉ TEINTE PLATE VISÉE : 1.11 W/H 1.04 D/S

GRAYNESS - NETTETÉ : N/A

HUE ERROR - DÉVIATION DE : N/A
TEINTE

INK EFFICIENCY : N/A
EFFICACITÉ DE L'ENCRE

DENSITOMETRY / DENSITOMÉTRIE

- CHANNEL-SÉLECTION: CYAN
- FILTER TYPE DE FILTRES: STATUS T
- FACTEUR n FACTOR: 2.7

* Pantone, Inc.'s check-standard trademark for colour reproduction and colour reproduction materials.
* La marque de Pantone, Inc. de contrôle uniforme pour la reproduction en couleur et les matériaux pour la reproduction en couleur.

CIE CHROMATICITY DIAGRAM(ME) DES CHROMATICITÉS CIE

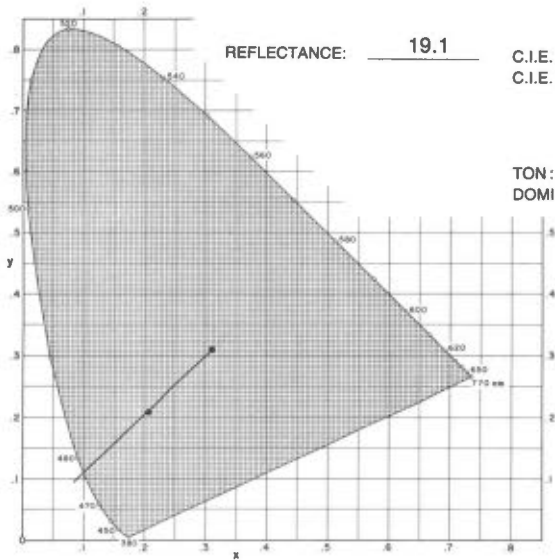

REFLECTANCE: 19.1 C.I.E. PURETÉ : 49%
C.I.E. PURITY

TON: 477
DOMINANT WAVELENGTH

Y: 19.1
X: 18.8
Z: 52.6

x: 0.205
y: 0.210

PAPER - PAPIER

GRADE / CATÉGORIE: W.S. NEW BRITE

TYPE: UNCOATED - NON COUCHÉ

REFLECTIVITÉ / REFLECTIVITY: 85%

OPACITÉ / OPACITY: 85.5%

% CONTRASTE/CONTRAST: 10%

PLATE - PLAQUE

SUBT. - SOUST.

TYPE: NEGATIVE

PRESS - PRESSE

• MEIHLE

• UNIT(É) #: LOWER/INFÉRIEURE

ID. PATCHES BLOCS IDEN.	% SCREEN TRAME	DENSITY DENSITÉ	% PRINT IMPRESSION
A	3	.12	7
B	6	.15	12
C	12	.19	19
D	22	.27	31
E	30	.36	41
F	40	.44	52
G	52	.57	68
H	66	.71	82
I	77	.81	90
J	87	.84	94
M	14	.24	26
N	27	.38	44
O	37	.45	52
P	51	.56	66
SOLID TEINTE PLATE	100	.90	100

The colour printed here was blended from, and should only be blended from PANTONE Basic Colours obtained from a PANTONE Licensed Printing Ink Manufacturer. Pantone, Inc. assumes no responsibility for the accuracy of the formulas or the colour reproduced.

La couleur ci-imprimée fut et devrait être mélangée seulement à partir des couleurs de base PANTONE obtenues d'un manufacturier d'encre autorisé. La compagnie Pantone, Inc. n'assume aucune responsabilité quant à l'exactitude du mélange ou de la couleur obtenue.

0
1
2
3
4
5
6
7
8
9

RDD - DRD

COLOURS AND SCREENS

COULEURS ET TRAMES

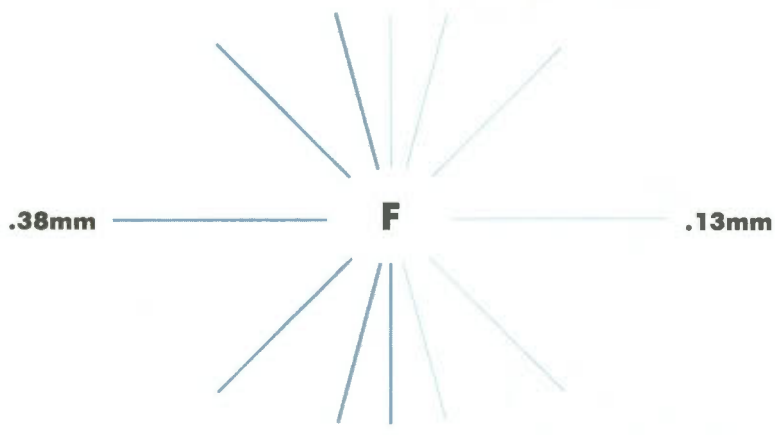

BIANGULAR SCREENS — TRAMES BIANGULÉES

M

6 pt. *Century Text Italic/Italique*
8 pt. *Triumvirate Roman/Romain*
10 pt. *Futura Roman/Romain*
12 pt. *CG Trade Condensed/Condensé*

.08mm
.13mm
.18mm
.25mm
.38mm

N

6 pt. *Triumvirate Roman/Romain*
8 pt. *Futura Roman/Romain*
10 pt. *CG Trade Condensed/Condensé*
12 pt. *Cent. Text It/Italique*

.08mm
.13mm
.18mm
.25mm
.38mm

O

6 pt. *Futura Roman/Romain*
8 pt. *CG Trade Condensed/Condensé*
10 pt. *Century Text Italic/Italique*
12 pt. *Trium. Rom./Romain*

.08mm
.13mm
.18mm
.25mm
.38mm

P

6 pt. *CG Trade Condensed/Condensé*
8 pt. *Century Text Italic/Italique*
10 pt. *Triumvirate Roman/Romain*
12 pt. *Futura Roman/Romain*

.08mm
.13mm
.18mm
.25mm
.38mm

SOLID — TEINTE PLATE

6 pt. *Century Text Italic/Italique*
8 pt. *Triumvirate Roman/Romain*
10 pt. *Futura Roman/Romain*
12 pt. *CG Trade Condensed/Condensé*

.08mm
.13mm
.18mm
.25mm
.38mm

A
B
C
D
E
F
G
H
I
J
S

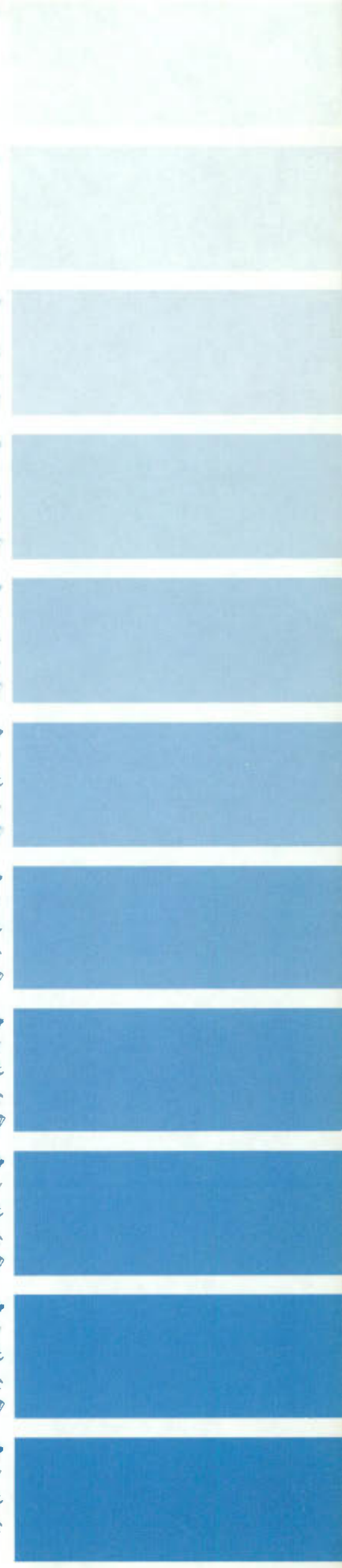

0
1
2
3
4
5
6
7
8
9

TECHNICAL INFORMATION — DONNÉES TECHNIQUES

INK - ENCRE

PANTONE® * FORMUL (A)
(E)

COLOUR No. COULEUR : 4780-113

- .1150 parts Pantone Process Blue
- .1150 parts Pantone Reflex Blue
- .7700 parts Pantone Extender

AIM SOLID DENSITY
DENSITÉ TEINTE PLATE VISÉE : 0.80 W/H 0.78 D/S

GRAYNESS - NETTETÉ : N/A

HUE ERROR - DÉVIATION DE : N/A
TEINTE

INK EFFICIENCY : N/A
EFFICACITÉ DE L'ENCRE

DENSITOMETRY / DENSITOMÉTRIE

- CHANNEL-SÉLECTION: CYAN
- FILTER TYPE DE FILTRES: STATUS T
- FACTEUR n FACTOR: 2.7

* Pantone, Inc.'s check-standard trademark for colour reproduction and colour reproduction materials.

* La marque de Pantone, Inc. de contrôle uniforme pour la reproduction en couleur et les matériaux pour la reproduction en couleur.

CIE CHROMATICITY DIAGRAM(ME) DES CHROMATICITÉS CIE

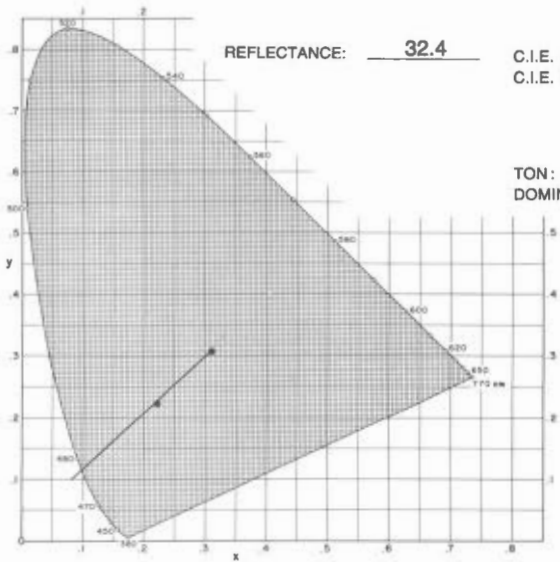

REFLECTANCE: 32.4 C.I.E. PURETÉ : 44%
C.I.E. PURITY

TON: 478
DOMINANT WAVELENGTH

Y: 32.4
X: 31.8
Z: 80.9

x: 0.220
y: 0.225

PAPER - PAPIER

GRADE / CATÉGORIE: W.S. STANDARD

TYPE: UNCOATED - NON COUCHÉ

REFLECTIVITÉ / REFLECTIVITY: 85%

OPACITÉ / OPACITY: 87%

% CONTRASTE/CONTRAST: 13%

PLATE - PLAQUE

SUBT. - SOUST.

TYPE: NEGATIVE

PRESS - PRESSE

• MEIHLE

• UNIT(É) #: LOWER/INFÉRIEURE

ID. PATCHES BLOCS IDEN.	% SCREEN TRAME	DENSITY DENSITÉ	% PRINT IMPRESSION
A	3	.09	3
B	6	.11	8
C	12	.15	15
D	22	.21	25
E	30	.27	37
F	40	.33	47
G	52	.45	64
H	66	.55	79
I	77	.61	89
J	87	.64	91
M	14	.17	19
N	27	.26	36
O	37	.32	46
P	51	.41	59
SOLID TEINTE PLATE	100	.70	100

The colour printed here was blended from, and should only be blended from PANTONE Basic Colours obtained from a PANTONE Licensed Printing Ink Manufacturer. Pantone, Inc. assumes no responsibility for the accuracy of the formulas or the colour reproduced.

La couleur ci-imprimée fut et devrait être mélangée seulement à partir des couleurs de base PANTONE obtenues d'un fabricant d'encre autorisé. La compagnie Pantone, Inc. n'assume aucune responsabilité quant à l'exactitude du mélange ou de la couleur obtenue.

RDD - DRD

COLOURS AND SCREENS

COULEURS ET TRAMES

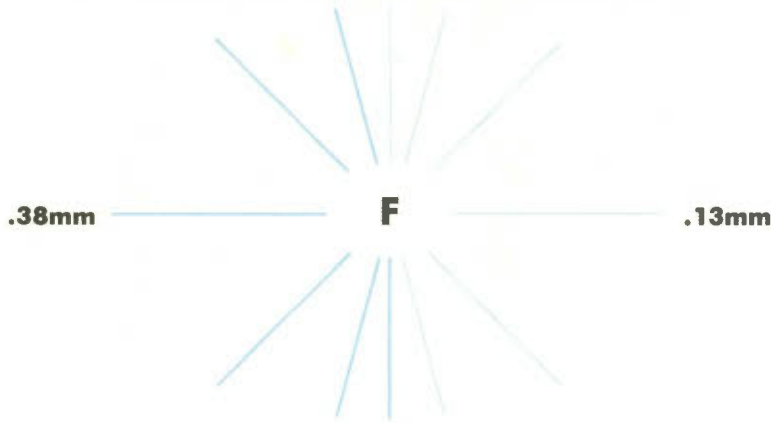

BIANGULAR SCREENS — TRAMES BIANGULÉES

M

4 pt. Triumvirate Roman/Romain	.06mm	
8 pt. Triumvirate Roman/Romain	.13mm	
10 pt. Futura Roman/Romain	.18mm	
12 pt. CG Trade Condensed/Condensé	.25mm	
	.38mm	

N

4 pt. Triumvirate Roman/Romain	.06mm	
8 pt. Futura Roman/Romain	.13mm	
10 pt. CG Trade Condensed/Condensé	.18mm	
12 pt. Cent. Text It./Italique	.25mm	
	.38mm	

O

4 pt. Futura Roman/Romain	.06mm	
8 pt. CG Trade Condensed/Condensé	.13mm	
10 pt. Century Text Italic/Italique	.18mm	
12 pt. Trium. Rom./Romain	.25mm	
	.38mm	

P

6 pt. CG Trade Condensed/Condensé	.06mm	
8 pt. Century Text Italic/Italique	.13mm	
10 pt. Triumvirate Roman/Romain	.18mm	
12 pt. Futura Roman/Romain	.25mm	
	.38mm	

SOLID — TEINTE PLATE

6 pt. Century Text Italic/Italique	.06mm	
8 pt. Triumvirate Roman/Romain	.13mm	
10 pt. Futura Roman/Romain	.18mm	
12 pt. CG Trade Condensed/Condensé	.25mm	
	.38mm	

A
B
C
D
E
F
G
H
I
J
S



TECHNICAL INFORMATION — DONNÉES TECHNIQUES

INK - ENCRE

PANTONE® * FORMUL (A/E)

COLOUR No. COULEUR : 4780-113

- .1150 parts Pantone Process Blue
- .1150 parts Pantone Reflex Blue
- .7700 parts Pantone Extender

AIM SOLID DENSITY
DENSITÉ TEINTE PLATE VISÉE : 0.79 W/H 0.72 D/S

GRAYNESS - NETTETÉ : N/A

HUE ERROR - DÉVIATION DE : N/A
TEINTE

INK EFFICIENCY : N/A
EFFICACITÉ DE L'ENCRE

DENSITOMETRY / DENSITOMÉTRIE

- CHANNEL-SÉLECTION: CYAN
- FILTER TYPE DE FILTRES: STATUS T
- FACTEUR n FACTOR: 2.7

* Pantone, Inc.'s check-standard trademark for colour reproduction and colour reproduction materials.
* La marque de Pantone, Inc. de contrôle uniforme pour la reproduction en couleur et les matériaux pour la reproduction en couleur.

CIE CHROMATICITY DIAGRAM(ME) DES CHROMATICITÉS CIE

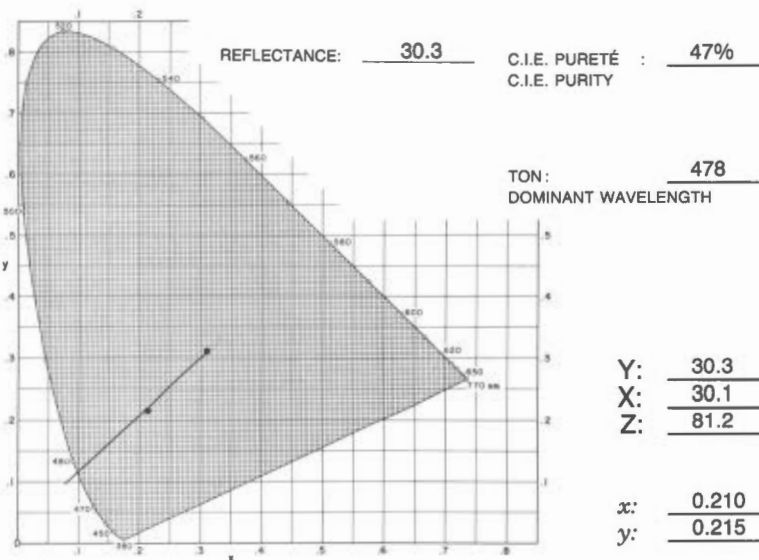

ID. PATCHES BLOCS IDEN.	% SCREEN FRAME	DENSITY DENSITÉ	% PRINT IMPRESSION
A	3	.10	4
B	6	.11	7
C	12	.15	15
D	22	.21	24
E	30	.27	35
F	40	.34	47
G	52	.45	63
H	66	.57	78
I	77	.63	87
J	87	.66	91
M	14	.17	19
N	27	.27	35
O	37	.33	44
P	51	.43	58
SOLID TEINTE PLATE	100	.73	100

PAPER - PAPIER

GRADE / CATÉGORIE: W.S. NEW BRITE

TYPE: UNCOATED - NON COUCHÉ

REFLECTIVITÉ / REFLECTIVITY: 83%

OPACITÉ / OPACITY: 85.5%

% CONTRASTE/CONTRAST: 10%

PLATE - PLAQUE

TYPE: SUBT. - SOUST.

TYPE: NEGATIVE

PRESS - PRESSE

• MEIHLE

• UNIT(É) #: LOWER/INFÉRIEURE

The colour printed here was blended from, and should only be blended from PANTONE Basic Colours obtained from a PANTONE Licensed Printing Ink Manufacturer.
Pantone, Inc. assumes no responsibility for the accuracy of the formulas or the colour reproduced.

La couleur ci-impriée fut et devrait être mélangée seulement à partir des couleurs de base PANTONE obtenues d'un fabricant d'encre autorisé.
La compagnie Pantone, Inc. n'assume aucune responsabilité quant à l'exactitude du mélange ou de la couleur obtenue.

RDD - DRD

COLOURS AND SCREENS

COULEURS ET TRAMES

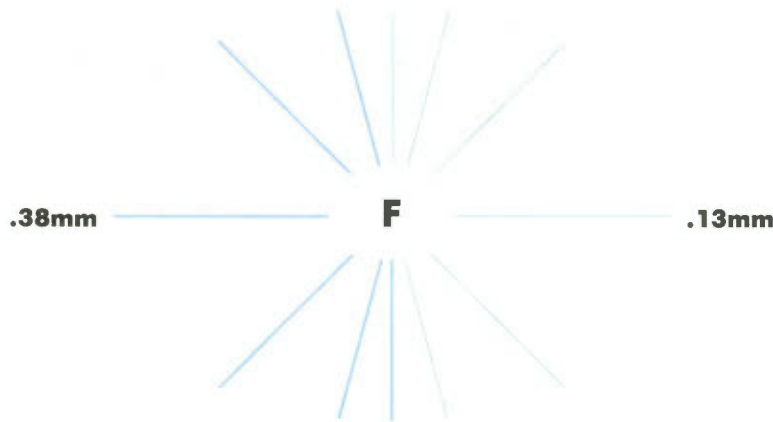

BIANGULAR SCREENS — TRAMES BIANGULÉES

M

6 pt. Triumvirate Roman/Romain	.08mm	
8 pt. Futura Roman/Romain	.13mm	
10 pt. Futura Roman/Romain	.18mm	
12 pt. CG Trade Condensed/Condensé	.25mm	
	.38mm	

N

6 pt. Triumvirate Roman/Romain	.08mm	
8 pt. Futura Roman/Romain	.13mm	
10 pt. CG Trade Condensed/Condensé	.18mm	
12 pt. Cent. Text It./Italique	.25mm	
	.38mm	

O

6 pt. Futura Roman/Romain	.08mm	
8 pt. CG Trade Condensed/Condensé	.13mm	
10 pt. Century Text Italic/Italique	.18mm	
12 pt. Trium. Rom./Romain	.25mm	
	.38mm	

P

6 pt. CG Trade Condensed/Condensé	.08mm	
8 pt. Century Text Italic/Italique	.13mm	
10 pt. Triumvirate Roman/Romain	.18mm	
12 pt. Futura Roman/Romain	.25mm	
	.38mm	

SOLID — TEINTE PLATE

6 pt. Century Text Italic/Italique	.08mm	
8 pt. Triumvirate Roman/Romain	.13mm	
10 pt. Futura Roman/Romain	.18mm	
12 pt. CG Trade Condensed/Condensé	.25mm	
	.38mm	

A
B
C
D
E
F
G
H
I
J
S

TECHNICAL INFORMATION — DONNÉES TECHNIQUES

INK - ENCRE

PANTONE® * FORMUL (A)
(E)

COLOUR No. COULEUR : 4780-113

- .1150 parts Pantone Process Blue
- .1150 parts Pantone Reflex Blue
- .7700 parts Pantone Extender

AIM SOLID DENSITY
DENSITÉ TEINTE PLATE VISÉE : 0.82 W/H 0.78 D/S

GRAYNESS - NETTETÉ : N/A

HUE ERROR - DÉVIATION DE : N/A
TEINTE

INK EFFICIENCY : N/A
EFFICACITÉ DE L'ENCRE

DENSITOMETRY / DENSITOMÉTRIE

- CHANNEL-SÉLECTION: CYAN
- FILTER TYPE DE FILTRES: STATUS T
- FACTEUR n FACTOR: 2.7

* Pantone, Inc.'s check-standard trademark for colour reproduction and colour reproduction materials.

* La marque de Pantone, Inc. de contrôle uniforme pour la reproduction en couleur et les matériaux pour la reproduction en couleur.

CIE CHROMATICITY DIAGRAM(ME) DES CHROMATICITÉS CIE

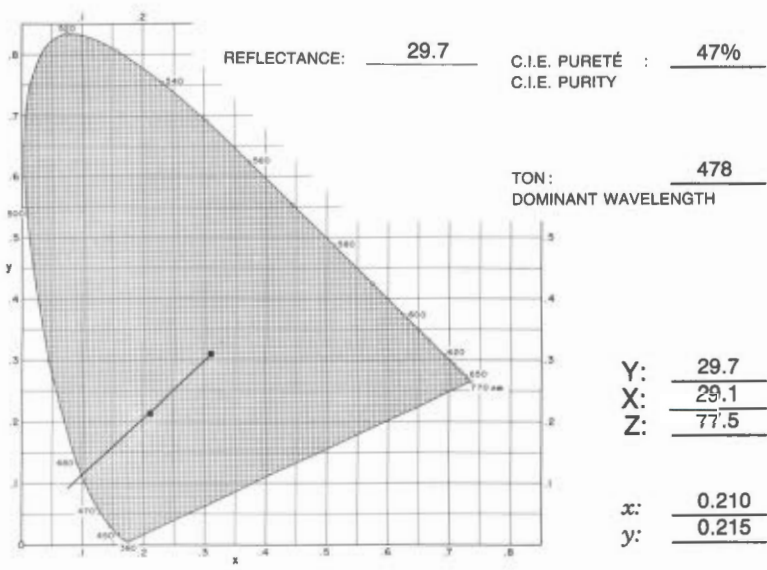

ID. PATCHES BLOCS IDEN.	% SCREEN TRAME	DENSITY DENSITÉ	% PRINT IMPRESSION
A	3	.08	5
B	6	.11	8
C	12	.15	16
D	22	.21	27
E	30	.27	35
F	40	.34	40
G	52	.47	65
H	66	.60	83
I	77	.67	90
J	87	.74	96
M	14	.17	20
N	27	.27	37
O	37	.35	49
P	51	.44	61
SOLID TEINTE PLATE	100	.76	100

PAPER - PAPIER

PLATE - PLAQUE

GRADE / CATÉGORIE: CHART

SUBT. - SOUST.

TYPE: UNCOATED - NON COUCHÉ

TYPE: NEGATIVE

REFLECTIVITÉ / REFLECTIVITY: 87%

PRESS - PRESSE

OPACITÉ / OPACITY: 96.5%

• MEIHLE

% CONTRASTE/CONTRAST: 12%

• UNIT(É) #: LOWER/INFÉRIEURE

The colour printed here was blended from, and should only be blended from PANTONE Basic Colours obtained from a PANTONE Licensed Printing Ink Manufacturer. Pantone, Inc. assumes no responsibility for the accuracy of the formulas or the colour reproduced.

La couleur ci-imprimée fut et devrait être mélangée seulement à partir des couleurs de base PANTONE obtenues d'un fabricant d'encre autorisé. La compagnie Pantone, Inc. n'assume aucune responsabilité quant à l'exactitude du mélange ou de la couleur obtenue.

RDD - DRD

COLOURS AND SCREENS

COULEURS ET TRAMES

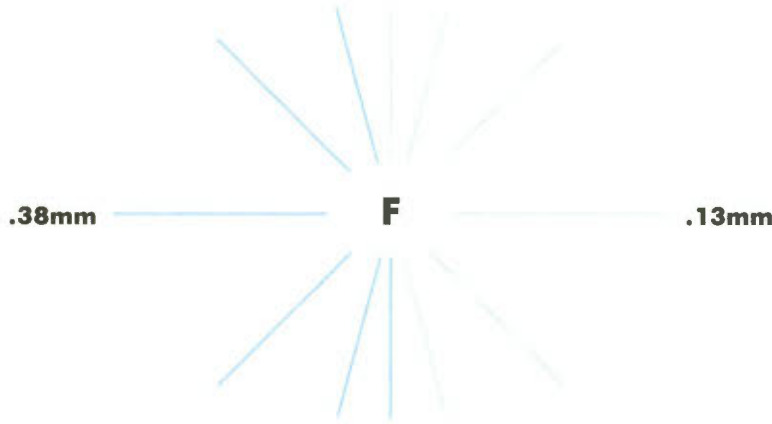

BIANGULAR SCREENS — TRAMES BIANGULÉES

M

.08mm
.13mm
.18mm
.25mm
.38mm

N

8 pt. Triumvirate Roman/Romain
8 pt. Futura Roman/Romain
10 pt. CG Trade Condensed/Condensé
12 pt. Cent. Text Italic/Italique

.08mm
.13mm
.18mm
.25mm
.38mm

O

6 pt. Futura Roman/Romain
8 pt. CG Trade Condensed/Condensé
10 pt. Century Text Italic/Italique
12 pt. Trium. Rom./Romain

.08mm
.13mm
.18mm
.25mm
.38mm

P

8 pt. CG Trade Condensed/Condensé
8 pt. Century Text Italic/Italique
10 pt. Triumvirate Roman/Romain
12 pt. Futura Roman/Romain

.08mm
.13mm
.18mm
.25mm
.38mm

SOLID — TEINTE PLATE

6 pt. Century Text Italic/Italique
8 pt. Triumvirate Roman/Romain
10 pt. Futura Roman/Romain
12 pt. CG Trade Condensed/Condensé

.08mm
.13mm
.18mm
.25mm
.38mm

A

B

C

D

E

F

G

H

I

J

S

TECHNICAL INFORMATION — DONNÉES TECHNIQUES

INK - ENCRE

PANTONE® * FORMUL (A/E)

COLOUR No. COULEUR : 4810-301

AIM SOLID DENSITY
DENSITÉ TEINTE PLATE VISÉE : 1.21 W/H 1.10 D/S

GRAYNESS - NETTETÉ : N/A

HUE ERROR - DÉVIATION DE : N/A
TEINTE

INK EFFICIENCY : N/A
EFFICACITÉ DE L'ENCRE

DENSITOMETRY / DENSITOMÉTRIE

• CHANNEL-SÉLECTION: CYAN

• FILTER TYPE DE FILTRES: STATUS T

• FACTEUR n FACTOR: 2.7

* Pantone, Inc.'s check-standard trademark for colour reproduction and colour reproduction materials.
* La marque de Pantone, Inc. de contrôle uniforme pour la reproduction en couleur et les matériaux pour la reproduction en couleur.

CIE CHROMATICITY DIAGRAM(ME) DES CHROMATICITÉS CIE

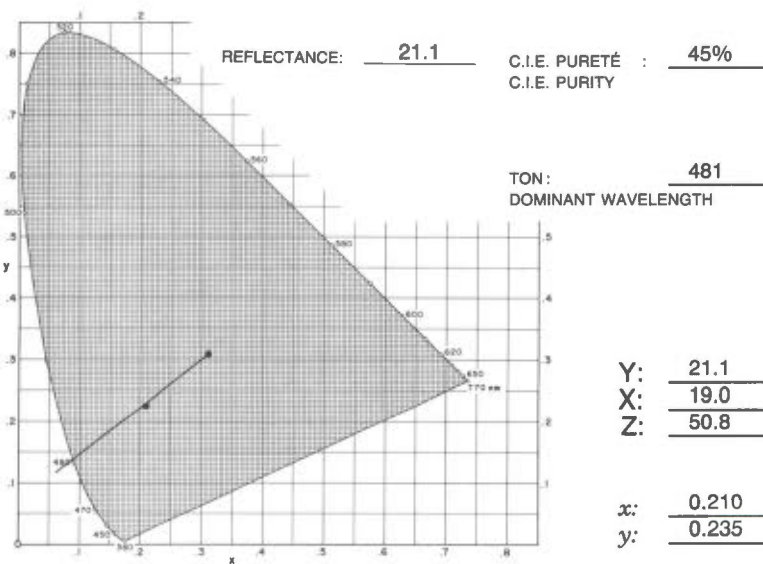

ID. PATCHES BLOCS IDEN.	% SCREEN TRAME	DENSITY DENSITÉ	% PRINT IMPRESSION
A	3	.10	5
B	6	.13	10
C	12	.18	18
D	22	.26	30
E	30	.35	41
F	40	.46	55
G	52	.60	69
H	66	.75	81
I	77	.83	92
J	87	.92	96
M	14	.23	26
N	27	.37	43
O	37	.45	54
P	51	.56	64
SOLID TEINTE PLATE	100	1.00	100

PAPER - PAPIER

GRADE / CATÉGORIE: W.S. STANDARD

TYPE: UNCOATED - NON COUCHÉ

REFLECTIVITÉ / REFLECTIVITY: 87%

OPACITÉ / OPACITY: 87%

% CONTRASTE/CONTRAST: 17%

PLATE - PLAQUE

SUBT. - SOUST.

TYPE: NEGATIVE

PRESS - PRESSE

• MEIHLE

• UNIT(É) #: LOWER/INFÉRIEURE

The colour printed here was blended from, and should only be blended from PANTONE Basic Colours obtained from a PANTONE Licensed Printing Ink Manufacturer.
Pantone, Inc. assumes no responsibility for the accuracy of the formulas or the colour reproduced.

La couleur ci-imprimée fut et devrait être mélangée seulement à partir des couleurs de base PANTONE obtenues d'un fabricant d'encre autorisé.
La compagnie Pantone, Inc. n'assume aucune responsabilité quant à l'exactitude du mélange ou de la couleur obtenue.

RDD - DRD

COLOURS AND SCREENS

COULEURS ET TRAMES

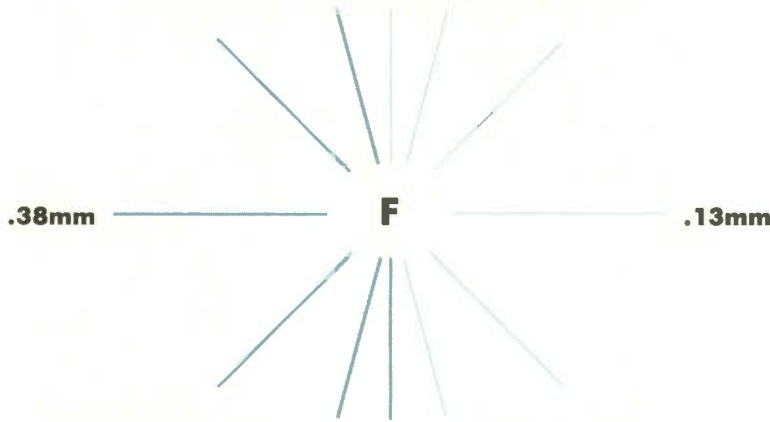

BIANGULAR SCREENS — TRAMES BIANGULÉES

M

6 pt. Century Text Italic/Italique	.08mm	
8 pt. Triumvirate Roman/Romain	.13mm	
10 pt. Futura Roman/Romain	.18mm	
12 pt. CG Trade Condensed/Condensé	.25mm	
	.38mm	

N

6 pt. Triumvirate Roman/Romain	.08mm	
8 pt. Futura Roman/Romain	.13mm	
10 pt. CG Trade Condensed/Condensé	.18mm	
12 pt. Cent. Text It/Italique	.25mm	
	.38mm	

O

6 pt. Futura Roman/Romain	.08mm	
8 pt. CG Trade Condensed/Condensé	.13mm	
10 pt. Century Text Italic/Italique	.18mm	
12 pt. Trium. Rom./Romain	.25mm	
	.38mm	

P

6 pt. CG Trade Condensed/Condensé	.08mm	
8 pt. Century Text Italic/Italique	.13mm	
10 pt. Triumvirate Roman/Romain	.18mm	
12 pt. Futura Roman/Romain	.25mm	
	.38mm	

SOLID — TEINTE PLATE

6 pt. Century Text Italic/Italique	.08mm	
8 pt. Triumvirate Roman/Romain	.13mm	
10 pt. Futura Roman/Romain	.18mm	
12 pt. CG Trade Condensed/Condensé	.25mm	
	.38mm	

A
B
C
D
E
F
G
H
I
J
S

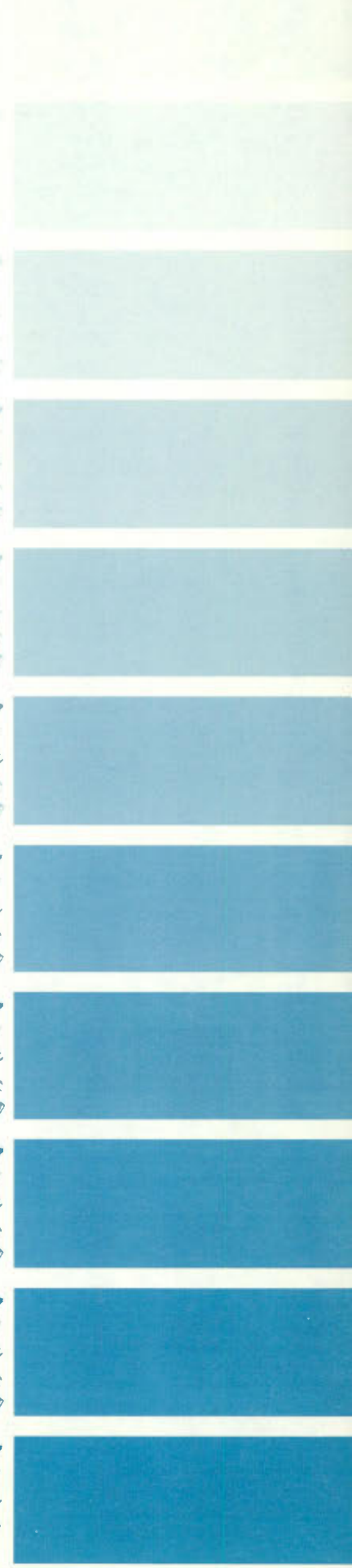

TECHNICAL INFORMATION — DONNÉES TECHNIQUES

INK - ENCRE

PANTONE® * FORMUL (A/E)

COLOUR No. COULEUR : 4810-301

AIM SOLID DENSITY
DENSITÉ TEINTE PLATE VISÉE : 1.19 W/H 1.07 D/S

GRAYNESS - NETTETÉ : N/A

HUE ERROR - DÉVIATION DE : N/A
TEINTE

INK EFFICIENCY : N/A
EFFICACITÉ DE L'ENCRE

DENSITOMETRY / DENSITOMÉTRIE

• CHANNEL-SÉLECTION: CYAN

• FILTER TYPE DE FILTRES: STATUS T

• FACTEUR n FACTOR: 2.7

* Pantone, Inc.'s check-standard trademark for colour reproduction and colour reproduction materials.
* La marque de Pantone, Inc. de contrôle uniforme pour la reproduction en couleur et les matériaux pour la reproduction en couleur.

CIE CHROMATICITY DIAGRAM(ME) DES CHROMATICITÉS CIE

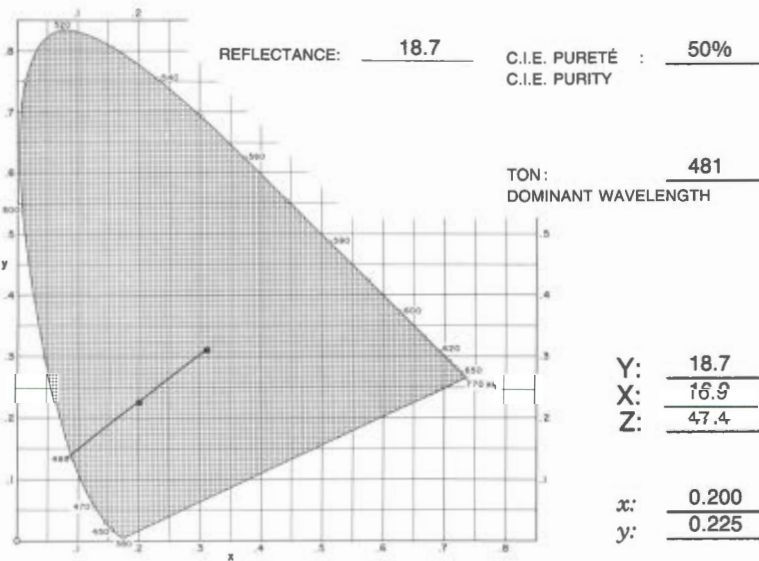

PAPER - PAPIER

GRADE / CATÉGORIE: W.S. NEW BRITE

TYPE: UNCOATED - NON COUCHÉ

REFLECTIVITÉ / REFLECTIVITY: 85%

OPACITÉ / OPACITY: 85.5%

% CONTRASTE/CONTRAST: 14%

PLATE - PLAQUE

TYPE: SUBT. - SOUST.

TYPE: NEGATIVE

PRESS - PRESSE

• MEIHLE

• UNIT(É) #: LOWER/INFÉRIEURE

ID. PATCHES BLOCS IDEN.	% SCREEN FRAME	DENSITY DENSITÉ	% PRINT IMPRESSION
A	3	.11	7
B	6	.15	11
C	12	.21	20
D	22	.29	31
E	30	.39	42
F	40	.49	56
G	52	.63	68
H	66	.76	80
I	77	.85	88
J	87	.92	94
M	14	.25	27
N	27	.39	45
O	37	.47	54
P	51	.57	65
SOLID TEINTE PLATE	100	.99	100

The colour printed here was blended from, and should only be blended from PANTONE Basic Colours obtained from a PANTONE Licensed Printing Ink Manufacturer.
Pantone, Inc. assumes no responsibility for the accuracy of the formulas or the colour reproduced.

La couleur ci-imprimée fut et devrait être mélangée seulement à partir des couleurs de base PANTONE obtenues d'un fabricant d'encre autorisé.
La compagnie Pantone, Inc. n'assume aucune responsabilité quant à l'exactitude du mélange ou de la couleur obtenue.

0
1
2
3
4
5
6
7
8
9

COLOUR NO. 301
No. DE COULEUR

RDD - DRD

COLOURS AND SCREENS

COULEURS ET TRAMES

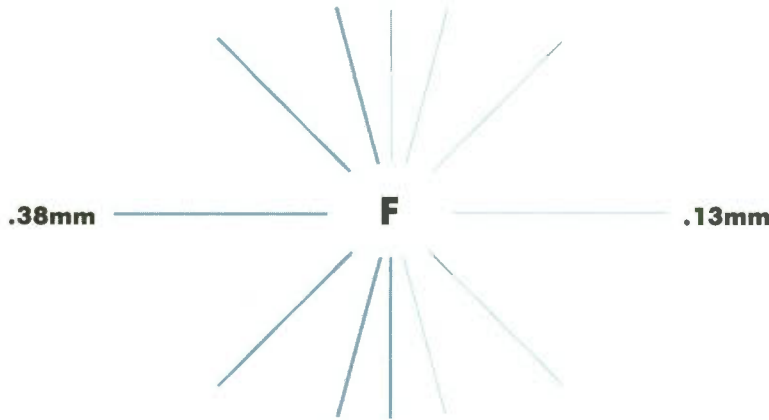

BIANGULAR SCREENS — TRAMES BIANGULÉES

M

6 pt. Century Text Italic/Italique	.08mm	
8 pt. Triumvirate Roman/Romain	.13mm	
10 pt. Futura Roman/Romain	.18mm	
12 pt. CG Trade Condensed/Condensé	.25mm	
	.38mm	

N

8 pt. Triumvirate Roman/Romain	.08mm	
8 pt. Futura Roman/Romain	.13mm	
10 pt. CG Trade Condensed/Condensé	.18mm	
12 pt. Cent. Text It./Italique	.25mm	
	.38mm	

O

6 pt. Futura Roman/Romain	.08mm	
8 pt. CG Trade Condensed/Condensé	.13mm	
10 pt. Century Text Italic/Italique	.18mm	
12 pt. Trium. Rom./Romain	.25mm	
	.38mm	

P

6 pt. CG Trade Condensed/Condensé	.08mm	
8 pt. Century Text Italic/Italique	.13mm	
10 pt. Triumvirate Roman/Romain	.18mm	
12 pt. Futura Roman/Romain	.25mm	
	.38mm	

SOLID — TEINTE PLATE

6 pt. Century Text Italic/Italique	.08mm	
8 pt. Triumvirate Roman/Romain	.13mm	
10 pt. Futura Roman/Romain	.18mm	
12 pt. CG Trade Condensed/Condensé	.25mm	
	.38mm	

A

B

C

D

E

F

G

H

I

J

S

0
1
2
3
4
5
6
7
8
9

TECHNICAL INFORMATION — DONNÉES TECHNIQUES

INK - ENCRE

PANTONE® * FORMUL (A/E)

COLOUR No. COULEUR : 4821-115

- .0380 parts Pantone Process Yellow
- .6330 parts Pantone Process Blue
- .2030 parts Pantone Reflex Blue
- .1260 parts Pantone Extender

AIM SOLID DENSITY
DENSITÉ TEINTE PLATE VISÉE : 0.82 W/H 0.81 D/S

GRAYNESS - NETTETÉ : N/A

HUE ERROR - DÉVIATION DE : N/A
TEINTE

INK EFFICIENCY : N/A
EFFICACITÉ DE L'ENCRE

DENSITOMETRY / DENSITOMÉTRIE

- CHANNEL-SÉLECTION: CYAN
- FILTER TYPE DE FILTRES: STATUS T
- FACTEUR n FACTOR: 2.7

* Pantone, Inc.'s check-standard trademark for colour reproduction and colour reproduction materials.
* La marque de Pantone, Inc. de contrôle uniforme pour la reproduction en couleur et les matériaux pour la reproduction en couleur.

CIE CHROMATICITY DIAGRAM(ME) DES CHROMATICITÉS CIE

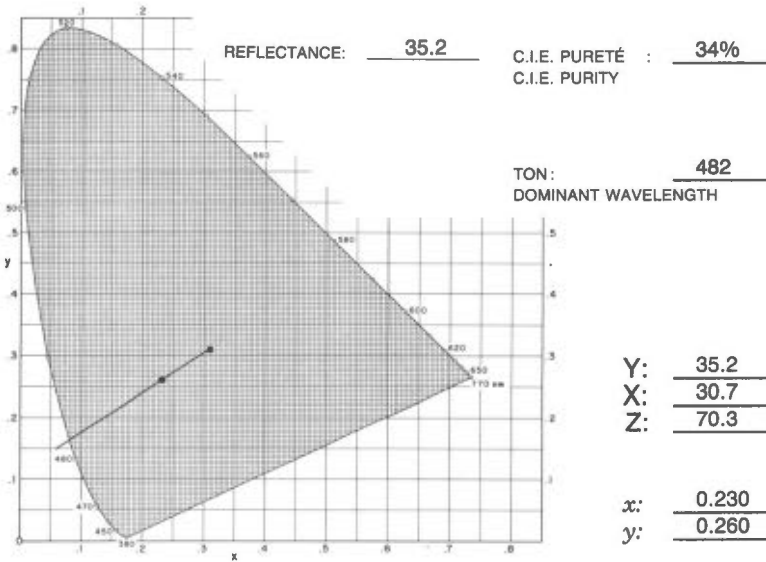

ID. PATCHES BLOCS IDEN.	% SCREEN TRAME	DENSITY DENSITÉ	% PRINT IMPRESSION
A	3	.09	5
B	6	.11	10
C	12	.15	18
D	22	.22	31
E	30	.28	42
F	40	.36	53
G	52	.46	66
H	66	.55	82
I	77	.61	87
J	87	.67	94
M	14	.19	24
N	27	.29	43
O	37	.36	54
P	51	.44	66
SOLID TEINTE PLATE	100	0.73	100

PAPER - PAPIER

GRADE / CATÉGORIE: W.S. STANDARD

TYPE: UNCOATED - NON COUCHÉ

REFLECTIVITÉ / REFLECTIVITY: 85%

OPACITÉ / OPACITY: 87%

% CONTRASTE/CONTRAST: 16%

PLATE - PLAQUE

SUBT. - SOUST.

TYPE: NEGATIVE

PRESS - PRESSE

• MEIHLE

• UNIT(É) #: LOWER/INFÉRIEURE

The colour printed here was blended from, and should only be blended from PANTONE Basic Colours obtained from a PANTONE Licensed Printing Ink Manufacturer.
Pantone, Inc. assumes no responsibility for the accuracy of the formulas or the colour reproduced.

La couleur ci-imprimée fut et devrait être mélangée seulement à partir des couleurs de base PANTONE obtenues d'un fabricant d'encre autorisé.
La compagnie Pantone, Inc. n'assume aucune responsabilité quant à l'exactitude du mélange ou de la couleur obtenue.

RDD - DRD

COLOURS AND SCREENS

COULEURS ET TRAMES

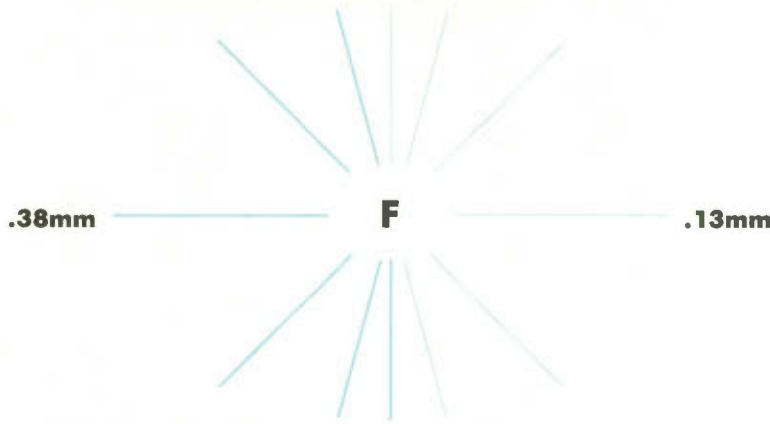

BIANGULAR SCREENS — TRAMES BIANGULÉES

M

6 pt. Triumvirate Roman/Romain
8 pt. Futura Roman/Romain
10 pt. Futura Roman/Romain
12 pt. CG Trade Condensed/Condensé

.08mm
.13mm
.18mm
.25mm
.38mm

N

6 pt. Triumvirate Roman/Romain
8 pt. Futura Roman/Romain
10 pt. CG Trade Condensed/Condensé
12 pt. Cent. Text It/Italique

.08mm
.13mm
.18mm
.25mm
.38mm

O

6 pt. Futura Roman/Romain
8 pt. CG Trade Condensed/Condensé
10 pt. Century Text Italic/Italique
12 pt. Trium. Rom./Romain

.08mm
.13mm
.18mm
.25mm
.38mm

P

6 pt. CG Trade Condensed/Condensé
8 pt. Century Text Italic/Italique
10 pt. Triumvirate Roman/Romain
12 pt. Futura Roman/Romain

.08mm
.13mm
.18mm
.25mm
.38mm

SOLID — TEINTE PLATE

6 pt. Century Text Italic/Italique
8 pt. Triumvirate Roman/Romain
10 pt. Futura Roman/Romain
12 pt. CG Trade Condensed/Condensé

.08mm
.13mm
.18mm
.25mm
.38mm

A

B

C

D

E

F

G

H

I

J

S

TECHNICAL INFORMATION — DONNÉES TECHNIQUES

INK - ENCRE

PANTONE® * FORMUL (A)
(E)

COLOUR No. COULEUR : 4821-115

- ___ .0380 parts Pantone Process Yellow
- ___ .6330 parts Pantone Process Blue
- ___ .2030 parts Pantone Reflex Blue
- ___ .1260 parts Pantone Extender

AIM SOLID DENSITY
DENSITÉ TEINTE PLATE VISÉE : 0.83 W/H 0.77 D/S

GRAYNESS - NETTETÉ : N/A

HUE ERROR - DÉVIATION DE : N/A
TEINTE

INK EFFICIENCY : N/A
EFFICACITÉ DE L'ENCRE

DENSITOMETRY / DENSITOMÉTRIE

- CHANNEL-SÉLECTION: CYAN
- FILTER TYPE DE FILTRES: STATUS T
- FACTEUR n FACTOR: 2.7

* Pantone, Inc.'s check-standard trademark for colour reproduction and colour reproduction materials.

* La marque de Pantone, Inc. de contrôle uniforme pour la reproduction en couleur et les matériaux pour la reproduction en couleur.

CIE CHROMATICITY DIAGRAM(ME) DES CHROMATICITÉS CIE

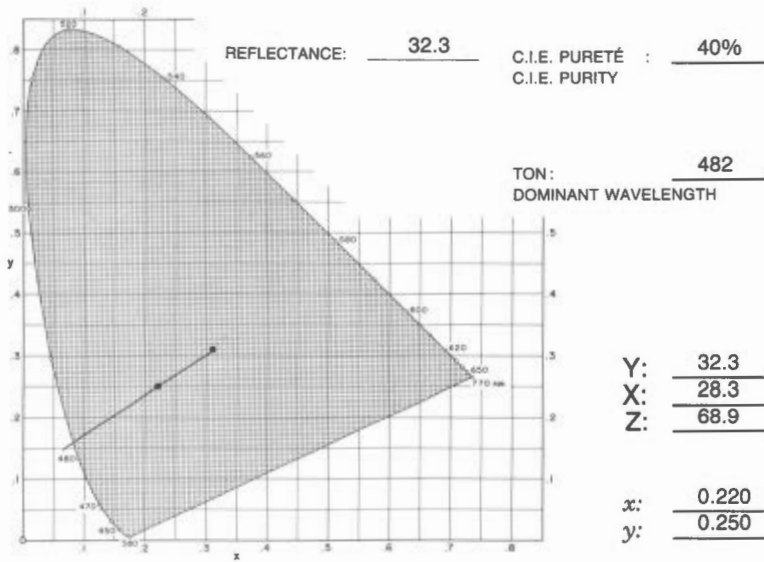

ID. PATCHES BLOCS IDEN.	% SCREEN TRAME	DENSITY DENSITÉ	% PRINT IMPRESSION
A	3	.11	6
B	6	.13	11
C	12	.17	19
D	22	.24	30
E	30	.29	40
F	40	.37	55
G	52	.45	63
H	66	.53	75
I	77	.60	83
J	87	.67	89
M	14	.20	25
N	27	.31	42
O	37	.36	50
P	51	.44	63
SOLID TEINTE PLATE	100	0.74	100

PAPER - PAPIER

PLATE - PLAQUE

GRADE / CATÉGORIE: W.S. NEW BRITE

SUBT. - SOUST. _____

TYPE: UNCOATED - NON COUCHÉ

TYPE:

NEGATIVE

REFLECTIVITÉ / REFLECTIVITY: 85%

PRESS - PRESSE

OPACITÉ / OPACITY: 85.5%

•

MEIHLE

% CONTRASTE/CONTRAST: 19%

•

UNIT(É) #: LOWER/INFÉRIEURE

The colour printed here was blended from, and should only be blended from PANTONE Basic Colours obtained from a PANTONE Licensed Printing Ink Manufacturer. Pantone, Inc. assumes no responsibility for the accuracy of the formulas or the colour reproduced.

La couleur ci-imprimée fut et devrait être mélangée seulement à partir des couleurs de base PANTONE obtenues d'un fabricant d'encre autorisé. La compagnie Pantone, Inc. n'assume aucune responsabilité quant à l'exactitude du mélange ou de la couleur obtenue.

RDD - DRD

COLOURS AND SCREENS

COULEURS ET TRAMES

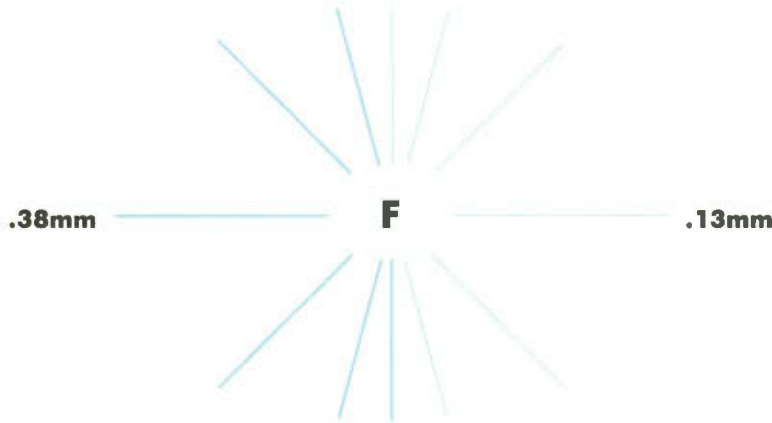

BIANGULAR SCREENS — TRAMES BIANGULÉES

M

4 pt. Triumvirate Roman/Romain	.08mm	
6 pt. Futura Roman/Romain	.13mm	
10 pt. Futura Roman/Romain	.18mm	
12 pt. CG Trade Condensed/Condensé	.25mm	
	.38mm	

N

8 pt. Triumvirate Roman/Romain	.08mm	
8 pt. Futura Roman/Romain	.13mm	
10 pt. CG Trade Condensed/Condensé	.18mm	
12 pt. Cent. Text It./Italique	.25mm	
	.38mm	

O

6 pt. Futura Roman/Romain	.08mm	
8 pt. CG Trade Condensed/Condensé	.13mm	
10 pt. Century Text Italic/Italique	.18mm	
12 pt. Trium. Rom./Romain	.25mm	
	.38mm	

P

6 pt. CG Trade Condensed/Condensé	.08mm	
8 pt. Century Text Italic/Italique	.13mm	
10 pt. Triumvirate Roman/Romain	.18mm	
12 pt. Futura Roman/Romain	.25mm	
	.38mm	

SOLID — TEINTE PLATE

6 pt. Century Text Italic/Italique	.08mm	
8 pt. Triumvirate Roman/Romain	.13mm	
10 pt. Futura Roman/Romain	.18mm	
12 pt. CG Trade Condensed/Condensé	.25mm	
	.38mm	

A

B

C

D

E

F

G

H

I

J

S

TECHNICAL INFORMATION — DONNÉES TECHNIQUES

INK - ENCRE

PANTONE® * FORMUL (A/E)

COLOUR No. COULEUR : 4823-4841

AIM SOLID DENSITY
DENSITÉ TEINTE PLATE VISÉE : 1.02 W/H 0.96 D/S

GRAYNESS - NETTETÉ : N/A

HUE ERROR - DÉVIATION DE : N/A
TEINTE

INK EFFICIENCY : N/A
EFFICACITÉ DE L'ENCRE

DENSITOMETRY / DENSITOMÉTRIE

• CHANNEL-SÉLECTION: CYAN

• FILTER TYPE DE FILTRES: STATUS T

• FACTEUR n FACTOR: 2.7

* Pantone, Inc.'s check-standard trademark for colour reproduction and colour reproduction materials.
* La marque de Pantone, Inc. de contrôle uniforme pour la reproduction en couleur et les matériaux pour la reproduction en couleur.

CIE CHROMATICITY DIAGRAM(ME) DES CHROMATICITÉS CIE

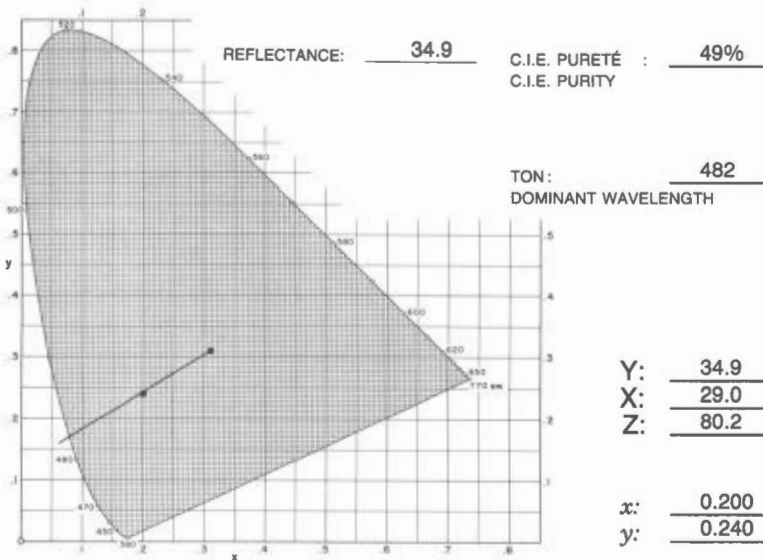

ID. PATCHES BLOCS IDEN.	% SCREEN TRAME	DENSITY DENSITÉ	% PRINT IMPRESSION
A	3	.10	6
B	6	.13	11
C	12	.18	19
D	22	.25	31
E	30	.33	43
F	40	.41	55
G	52	.52	67
H	66	.62	81
I	77	.71	88
J	87	.77	94
M	14	.22	26
N	27	.33	43
O	37	.41	53
P	51	.49	65
SOLID TEINTE PLATE	100	.82	100

PAPER - PAPIER

GRADE / CATÉGORIE: W.S. STANDARD

TYPE: UNCOATED - NON COUCHÉ

REFLECTIVITÉ / REFLECTIVITY: 87%

OPACITÉ / OPACITY: 87%

% CONTRASTE/CONTRAST: 13%

PLATE - PLAQUE

TYPE: SUBT. - SOUST.

TYPE: NEGATIVE

PRESS - PRESSE

• MEIHLE

• UNIT(É) #: LOWER/INFÉRIEURE

The colour printed here was blended from, and should only be blended from PANTONE Basic Colours obtained from a PANTONE Licensed Printing Ink Manufacturer. Pantone, Inc. assumes no responsibility for the accuracy of the formulas or the colour reproduced.

La couleur ci-imprimée fut et devrait être mélangée seulement à partir des couleurs de base PANTONE obtenues d'un fabricant d'encre autorisé. La compagnie Pantone, Inc. n'assume aucune responsabilité quant à l'exactitude du mélange ou de la couleur obtenue.

RDD - DRD
COLOURS AND SCREENS
COULEURS ET TRAMES

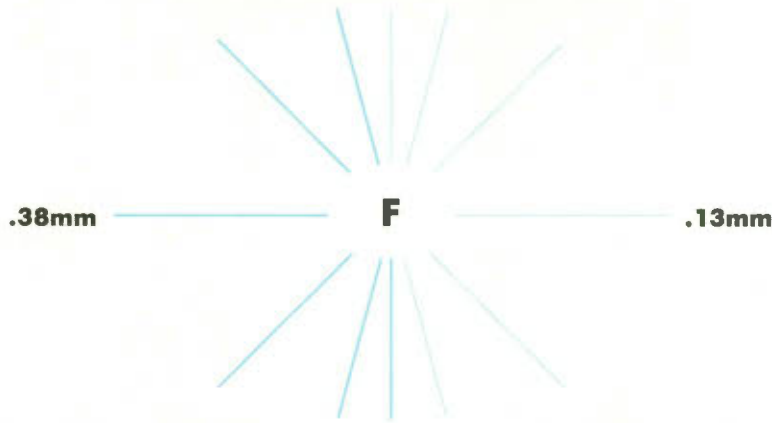

BIANGULAR SCREENS — TRAMES BIANGULÉES

M

6 pt. Triumvirate Roman/Romain
8 pt. Futuro Roman/Romain
10 pt. CG Trade Condensed/Condensé
12 pt. CG Trade Condensed/Condensé



N

6 pt. Triumvirate Roman/Romain
8 pt. Futuro Roman/Romain
10 pt. CG Trade Condensed/Condensé
12 pt. Cent. Text It./Italique



O

6 pt. Futuro Roman/Romain
8 pt. CG Trade Condensed/Condensé
10 pt. Century Text Italic/Italique
12 pt. Trium. Rom./Romain



P

6 pt. CG Trade Condensed/Condensé
8 pt. Century Text Italic/Italique
10 pt. Triumvirate Roman/Romain
12 pt. Futuro Roman/Romain



SOLID — TEINTE PLATE

6 pt. Century Text Italic/Italique
8 pt. Triumvirate Roman/Romain
10 pt. Futuro Roman/Romain
12 pt. CG Trade Condensed/Condensé



A

B

C

D

E

F

G

H

I

J

S

TECHNICAL INFORMATION — DONNÉES TECHNIQUES

INK - ENCRE

PANTONE® * FORMUL (A/E)

COLOUR No. COULEUR : 4823-4841

AIM SOLID DENSITY
DENSITÉ TEINTE PLATE VISÉE : 1.03 W/H 0.92 D/S

GRAYNESS - NETTETÉ : N/A

HUE ERROR - DÉVIATION DE : N/A
TEINTE

INK EFFICIENCY : N/A
EFFICACITÉ DE L'ENCRE

DENSITOMETRY / DENSITOMÉTRIE

- CHANNEL-SÉLECTION: CYAN
- FILTER TYPE DE FILTRES: STATUS T
- FACTEUR n FACTOR: 2.7

* Pantone, Inc.'s check-standard trademark for colour reproduction and colour reproduction materials.

* La marque de Pantone, Inc. de contrôle uniforme pour la reproduction en couleur et les matériaux pour la reproduction en couleur.

CIE CHROMATICITY DIAGRAM(ME) DES CHROMATICITÉS CIE

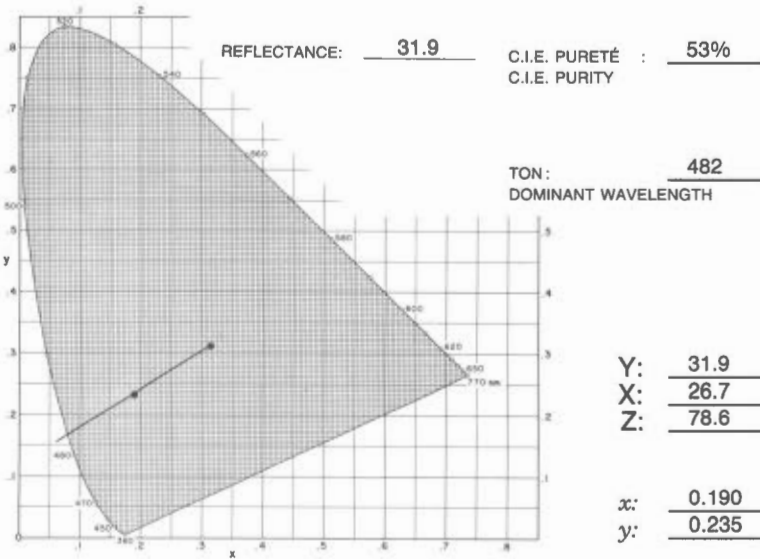

PAPER - PAPIER

PLATE - PLAQUE

GRADE / CATÉGORIE: W.S. NEW BRITE

SUBT. - SOUST.

TYPE: UNCOATED - NON COUCHÉ

TYPE: NEGATIVE

REFLECTIVITÉ / REFLECTIVITY: 87%

PRESS - PRESSE

OPACITÉ / OPACITY: 85.5%

• MEIHLE

% CONTRASTE/CONTRAST: 17%

• UNIT(É) #: LOWER/INFÉRIEURE

ID. PATCHES BLOCS IDEN.	% SCREEN TRAME	DENSITY DENSITÉ	% PRINT IMPRESSION
A	3	.10	6
B	6	.14	11
C	12	.18	19
D	22	.25	31
E	30	.34	41
F	40	.43	56
G	52	.55	67
H	66	.67	79
I	77	.74	87
J	87	.82	93
M	14	.22	25
N	27	.35	44
O	37	.43	53
P	51	.52	64
SOLID TEINTE PLATE	100	.89	100

The colour printed here was blended from, and should only be blended from PANTONE Basic Colours obtained from a PANTONE Licensed Printing Ink Manufacturer. Pantone, Inc. assumes no responsibility for the accuracy of the formulas or the colour reproduced.

La couleur ci-imprimée fut et devrait être mélangée seulement à partir des couleurs de base PANTONE obtenues d'un fabricant d'encre autorisé. La compagnie Pantone, Inc. n'assume aucune responsabilité quant à l'exactitude du mélange ou de la couleur obtenue.

RDD - DRD

COLOURS AND SCREENS

COULEURS ET TRAMES

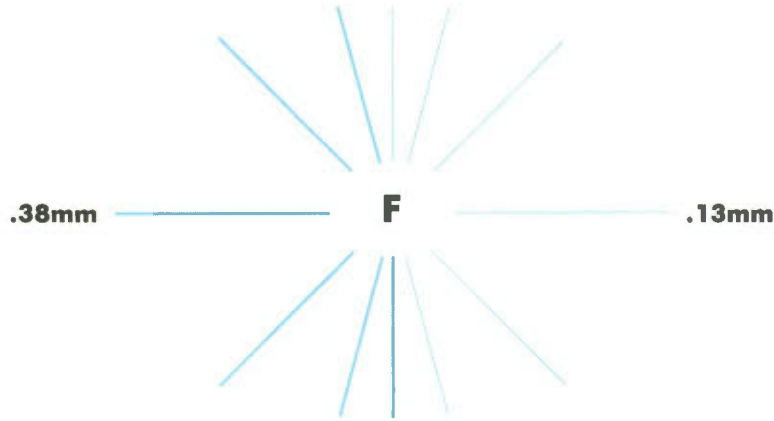

BIANGULAR SCREENS — TRAMES BIANGULÉES

M

6 pt. <i>Triumvirate Roman/Romain</i>	.08mm	
8 pt. <i>Triumvirate Roman/Romain</i>	.13mm	
10 pt. <i>Futura Roman/Romain</i>	.18mm	
12 pt. <i>CG Trade Condensed/Condensé</i>	.25mm	
	.38mm	

N

6 pt. <i>Triumvirate Roman/Romain</i>	.08mm	
8 pt. <i>Futura Roman/Romain</i>	.13mm	
10 pt. <i>CG Trade Condensed/Condensé</i>	.18mm	
12 pt. <i>Cent. Text It./Italique</i>	.25mm	
	.38mm	

O

6 pt. <i>Futura Roman/Romain</i>	.08mm	
8 pt. <i>CG Trade Condensed/Condensé</i>	.13mm	
10 pt. <i>Century Text Italic/Italique</i>	.18mm	
12 pt. <i>Trium. Rom./Romain</i>	.25mm	
	.38mm	

P

6 pt. <i>CG Trade Condensed/Condensé</i>	.08mm	
8 pt. <i>Century Text Italic/Italique</i>	.13mm	
10 pt. <i>Triumvirate Roman/Romain</i>	.18mm	
12 pt. <i>Futura Roman/Romain</i>	.25mm	
	.38mm	

SOLID — TEINTE PLATE

6 pt. <i>Century Text Italic/Italique</i>	.08mm	
8 pt. <i>Triumvirate Roman/Romain</i>	.13mm	
10 pt. <i>Futura Roman/Romain</i>	.18mm	
12 pt. <i>CG Trade Condensed/Condensé</i>	.25mm	
	.38mm	

A

B

C

D

E

F

G

H

I

J

S

TECHNICAL INFORMATION — DONNÉES TECHNIQUES

INK - ENCRE

PANTONE® * FORMUL (A/E)

COLOUR No. COULEUR : 4910-118

- .0090 parts Pantone 012 Yellow
- .0900 parts Pantone Process Blue
- .9010 parts Pantone Extender

AIM SOLID DENSITY
DENSITÉ TEINTE PLATE VISÉE : 0.30 W/H 0.29 D/S

GRAYNESS - NETTETÉ : N/A

HUE ERROR - DÉVIATION DE : N/A
TEINTE

INK EFFICIENCY : N/A
EFFICACITÉ DE L'ENCRE

DENSITOMETRY / DENSITOMÉTRIE

- CHANNEL-SÉLECTION: CYAN
- FILTER TYPE DE FILTRES: STATUS T
- FACTEUR n FACTOR: 2.7

* Pantone, Inc.'s check-standard trademark for colour reproduction and colour reproduction materials.

* La marque de Pantone, Inc. de contrôle uniforme pour la reproduction en couleur et les matériaux pour la reproduction en couleur.

CIE CHROMATICITY DIAGRAM(ME) DES CHROMATICITÉS CIE

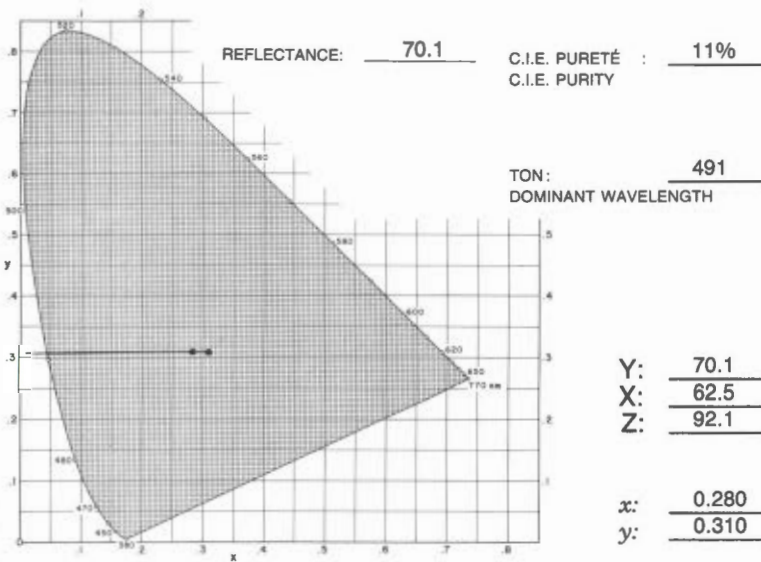

ID. PATCHES BLOCS IDEN.	% SCREEN FRAME	DENSITY DENSITÉ	% PRINT IMPRESSION
A	3	.07	1
B	6	.08	6
C	12	.10	14
D	22	.12	24
E	30	.15	36
F	40	.17	47
G	52	.19	59
H	66	.23	73
I	77	.25	79
J	87	.27	89
M	14	.10	15
N	27	.15	36
O	37	.16	44
P	51	.18	57
SOLID TEINTE PLATE	100	.29	100

PAPER - PAPIER

GRADE / CATÉGORIE: W.S. STANDARD

TYPE: UNCOATED - NON COUCHÉ

REFLECTIVITÉ / REFLECTIVITY: 85%

OPACITÉ / OPACITY: 87%

% CONTRASTE/CONTRAST: 14%

PLATE - PLAQUE

SUBT. - SOUST.

TYPE: NEGATIVE

PRESS - PRESSE

• MEIHLE

• UNIT(É) #: LOWER/INFÉRIEURE

The colour printed here was blended from, and should only be blended from PANTONE Basic Colours obtained from a PANTONE Licensed Printing Ink Manufacturer. Pantone, Inc. assumes no responsibility for the accuracy of the formulas or the colour reproduced.

La couleur ci-imprimée fut et devrait être mélangée seulement à partir des couleurs de base PANTONE obtenues d'un fabricant d'encre autorisé. La compagnie Pantone, Inc. n'assume aucune responsabilité quant à l'exactitude du mélange ou de la couleur obtenue.

RDD - DRD

COLOURS AND SCREENS

COULEURS ET TRAMES

.38mm **F** **.13mm**

BIANGULAR SCREENS — TRAMES BIANGULÉES

M

.08mm
.13mm
.18mm
.25mm
.38mm

N

.08mm
.13mm
.18mm
.25mm
.38mm

O

.08mm
.13mm
.18mm
.25mm
.38mm

P

.08mm
.13mm
.18mm
.25mm
.38mm

SOLID — TEINTE PLATE

7 pt. Futura Condensed/Condensé
8 pt. Triumvirate Roman/Romain
10 pt. Futura Roman/Romain
12 pt. CG Trade Condensed/Condensé

.08mm
.13mm
.18mm
.25mm
.38mm

A

B

C

D

E

F

G

H

I

J

S

TECHNICAL INFORMATION — DONNÉES TECHNIQUES

INK - ENCRE

PANTONE® * FORMUL (A)
(E)

COLOUR No. COULEUR : 4910-118

- .0090 parts Pantone 012 Yellow
- .0900 parts Pantone Process Blue
- .9010 parts Pantone Extender

AIM SOLID DENSITY
DENSITÉ TEINTE PLATE VISÉE : 0.32 W/H 0.31 D/S

GRAYNESS - NETTETÉ : N/A

HUE ERROR - DÉVIATION DE : N/A
TEINTE

INK EFFICIENCY : N/A
EFFICACITÉ DE L'ENCRE

DENSITOMETRY / DENSITOMÉTRIE

- CHANNEL-SÉLECTION: CYAN
- FILTER TYPE DE FILTRES: STATUS T
- FACTEUR n FACTOR: 2.7

* Pantone, Inc.'s check-standard trademark for colour reproduction and colour reproduction materials.

* La marque de Pantone, Inc. de contrôle uniforme pour la reproduction en couleur et les matériaux pour la reproduction en couleur.

CIE CHROMATICITY DIAGRAM(ME) DES CHROMATICITÉS CIE

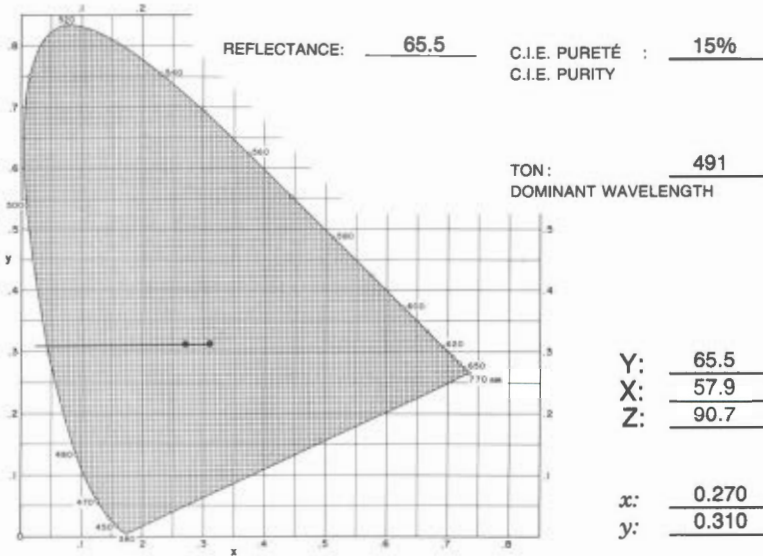

ID. PATCHES BLOCS IDEN.	% SCREEN FRAME	DENSITY DENSITÉ	% PRINT IMPRESSION
A	3	.08	1
B	6	.08	4
C	12	.10	12
D	22	.13	22
E	30	.16	33
F	40	.18	41
G	52	.21	55
H	66	.24	68
I	77	.26	79
J	87	.28	84
M	14	.11	14
N	27	.15	32
O	37	.17	40
P	51	.20	52
SOLID TEINTE PLATE	100	.31	100

PAPER - PAPIER

GRADE / CATÉGORIE: W.S. NEW BRITE

TYPE: UNCOATED - NON COUCHÉ

REFLECTIVITÉ / REFLECTIVITY: 83%

OPACITÉ / OPACITY: 85.5%

% CONTRASTE/CONTRAST: 16%

PLATE - PLAQUE

SUBT. - SOUST.

TYPE: NEGATIVE

PRESS - PRESSE

• MEIHLE

• UNIT(É) #: LOWER/INFÉRIEURE

The colour printed here was blended from, and should only be blended from PANTONE Basic Colours obtained from a PANTONE Licensed Printing Ink Manufacturer. Pantone, Inc. assumes no responsibility for the accuracy of the formulas or the colour reproduced.

La couleur ci-Imprimée fut et devrait être mélangée seulement à partir des couleurs de base PANTONE obtenues d'un fabricant d'encre autorisé. La compagnie Pantone, Inc. n'assume aucune responsabilité quant à l'exactitude du mélange ou de la couleur obtenue.

TECHNICAL INFORMATION — DONNÉES TECHNIQUES

INK - ENCRE

PANTONE® * FORMUL (A)_E

COLOUR No. COULEUR : 4910-118

- .0090 parts Pantone 012 Yellow
- .0900 parts Pantone Process Blue
- .9010 parts Pantone Extender

AIM SOLID DENSITY
DENSITÉ TEINTE PLATE VISÉE : 0.30 W/H 0.29 D/S

GRAYNESS - NETTETÉ : N/A

HUE ERROR - DÉVIATION DE : N/A
TEINTE

INK EFFICIENCY : N/A
EFFICACITÉ DE L'ENCRE

DENSITOMETRY / DENSITOMÉTRIE

- CHANNEL-SÉLECTION: CYAN
- FILTER TYPE DE FILTRES: STATUS T
- FACTEUR n FACTOR: 2.7

* Pantone, Inc.'s check-standard trademark for colour reproduction and colour reproduction materials.
* La marque de Pantone, Inc. de contrôle uniforme pour la reproduction en couleur et les matériaux pour la reproduction en couleur.

CIE CHROMATICITY DIAGRAM(ME) DES CHROMATICITÉS CIE

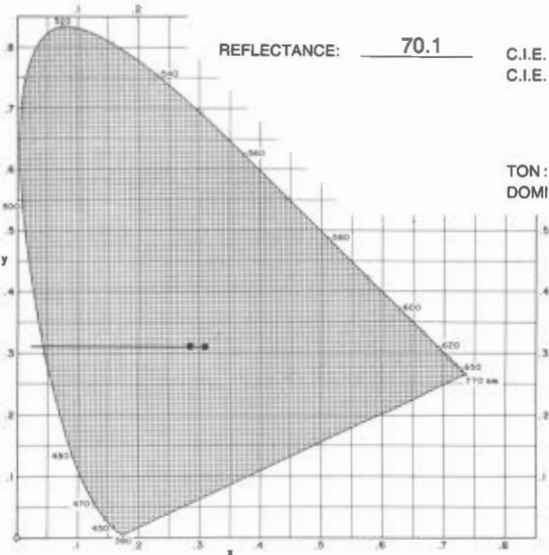

ID. PATCHES BLOCS IDEN.	% SCREEN TRAME	DENSITY DENSITÉ	% PRINT IMPRESSION
A	3	.07	3
B	6	.07	5
C	12	.09	12
D	22	.11	22
E	30	.13	33
F	40	.15	43
G	52	.18	55
H	66	.21	68
I	77	.23	75
J	87	.25	86
M	14	.09	16
N	27	.13	33
O	37	.15	43
P	51	.18	54
SOLID TEINTE PLATE	100	.28	100

PAPER - PAPIER

GRADE / CATÉGORIE: CHART

TYPE: UNCOATED - NON COUCHÉ

REFLECTIVITÉ / REFLECTIVITY: 87%

OPACITÉ / OPACITY: 96.5%

% CONTRASTE/CONTRAST: 18%

PLATE - PLAQUE

TYPE: SUBT. - SOUST.

TYPE: NEGATIVE

PRESS - PRESSE

• MEIHLE

• UNIT(É) #: LOWER/INFÉRIEURE

The colour printed here was blended from, and should only be blended from PANTONE Basic Colours obtained from a PANTONE Licensed Printing Ink Manufacturer.
Pantone, Inc. assumes no responsibility for the accuracy of the formulas or the colour reproduced.

La couleur ci-imprimée fut et devrait être mélangée seulement à partir des couleurs de base PANTONE obtenues d'un fabricant d'encre autorisé.
La compagnie Pantone, Inc. n'assume aucune responsabilité quant à l'exactitude du mélange ou de la couleur obtenue.

RDD - DRD

COLOURS AND SCREENS

COULEURS ET TRAMES

.38mm

F

.13mm

BIANGULAR SCREENS — TRAMES BIANGULÉES

M

- .08mm
- .13mm
- .18mm
- .25mm
- .38mm

N

- .08mm
- .13mm
- .18mm
- .25mm
- .38mm

O

- .08mm
- .13mm
- .18mm
- .25mm
- .38mm

P

- .08mm
- .13mm
- .18mm
- .25mm
- .38mm

SOLID — TEINTE PLATE

10 pt. Full-Color Reproduction Process
12 pt. CG Trade Colorants/Colorants

- .08mm
- .13mm
- .18mm
- .25mm
- .38mm



A

B

C

D

E

F

G

H

I

J

S

TECHNICAL INFORMATION — DONNÉES TECHNIQUES

INK - ENCRE

PANTONE® * FORMUL (A/E)

COLOUR No. COULEUR : 4930-110

- .0130 parts Pantone Green
- .0320 parts Pantone Process Blue
- .9550 parts Pantone Extender

AIM SOLID DENSITY
DENSITÉ TEINTE PLATE VISÉE : 0.27 W/H 0.13 D/S

GRAYNESS - NETTETÉ : N/A

HUE ERROR - DÉVIATION DE : N/A
TEINTE

INK EFFICIENCY : N/A
EFFICACITÉ DE L'ENCRE

DENSITOMETRY / DENSITOMÉTRIE

- CHANNEL-SÉLECTION: CYAN
- FILTER TYPE DE FILTRES: STATUS T
- FACTEUR n FACTOR: 2.7

* Pantone, Inc.'s check-standard trademark for colour reproduction and colour reproduction materials.

* La marque de Pantone, Inc. de contrôle uniforme pour la reproduction en couleur et les matériaux pour la reproduction en couleur.

CIE CHROMATICITY DIAGRAM(ME) DES CHROMATICITÉS CIE

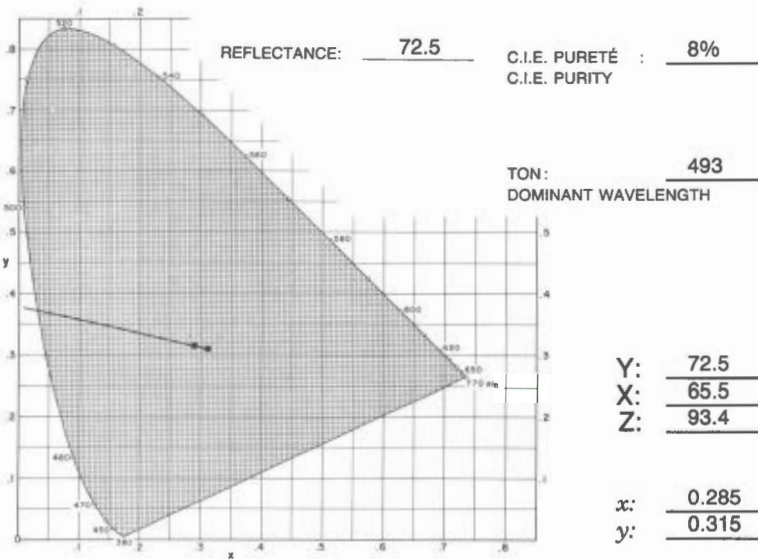

ID. PATCHES BLOCS IDEN.	% SCREEN TRAME	DENSITY DENSITÉ	% PRINT IMPRESSION
A	3	.07	3
B	6	.09	5
C	12	.08	11
D	22	.08	16
E	30	.09	27
F	40	.10	43
G	52	.10	58
H	66	.11	64
I	77	.12	79
J	87	.12	93
M	14	.08	5
N	27	.08	16
O	37	.09	32
P	51	.10	37
SOLID TEINTE PLATE	100	.13	100

PAPER - PAPIER

GRADE / CATÉGORIE: W.S. STANDARD

TYPE: UNCOATED - NON COUCHÉ

REFLECTIVITÉ / REFLECTIVITY: 85%

OPACITÉ / OPACITY: 87%

% CONTRASTE/CONTRAST: 8%

PLATE - PLAQUE

SUBT. - SOUST.

TYPE: NEGATIVE

PRESS - PRESSE

• MEIHLE

• UNIT(É) #: LOWER/INFÉRIEURE

The colour printed here was blended from, and should only be blended from PANTONE Basic Colours obtained from a PANTONE Licensed Printing Ink Manufacturer. Pantone, Inc. assumes no responsibility for the accuracy of the formulas or the colour reproduced.

La couleur ci-imprimée fut et devrait être mélangée seulement à partir des couleurs de base PANTONE obtenues d'un fabricant d'encre autorisé. La compagnie Pantone, Inc. n'assume aucune responsabilité quant à l'exactitude du mélange ou de la couleur obtenue.

RDD - DRD
COLOURS AND SCREENS
COULEURS ET TRAMES

.38mm **F** **.13mm**

BIANGULAR SCREENS — TRAMES BIANGULÉES

M

- .08mm
- .13mm
- .18mm
- .25mm
- .38mm

N

- .08mm
- .13mm
- .18mm
- .25mm
- .38mm

O

- .08mm
- .13mm
- .18mm
- .25mm
- .38mm

P

- .08mm
- .13mm
- .18mm
- .25mm
- .38mm

SOLID — TEINTE PLATE

8 pt. Triumphator Romani/Român
10 pt. Futura Romani/Român
12 pt. CG Trade Condensed/Condensã

- .08mm
- .13mm
- .18mm
- .25mm
- .38mm

A

B

C

D

E

F

G

H

I

J

S

TECHNICAL INFORMATION — DONNÉES TECHNIQUES

INK - ENCRE

PANTONE® * FORMUL (A/E)

COLOUR No. COULEUR : 4930-110

- .0130 parts Pantone Green
- .0320 parts Pantone Process Blue
- .9550 parts Pantone Extender

AIM SOLID DENSITY
DENSITÉ TEINTE PLATE VISÉE : 0.29 W/H 0.28 D/S

GRAYNESS - NETTETÉ : N/A

HUE ERROR - DÉVIATION DE : N/A
TEINTE

INK EFFICIENCY : N/A
EFFICACITÉ DE L'ENCRE

DENSITOMETRY / DENSITOMÉTRIE

- CHANNEL-SÉLECTION: CYAN
- FILTER TYPE DE FILTRES: STATUS T
- FACTEUR n FACTOR: 2.7

* Pantone, Inc.'s check-standard trademark for colour reproduction and colour reproduction materials.
* La marque de Pantone, Inc. de contrôle uniforme pour la reproduction en couleur et les matériaux pour la reproduction en couleur.

CIE CHROMATICITY DIAGRAM(ME) DES CHROMATICITÉS CIE

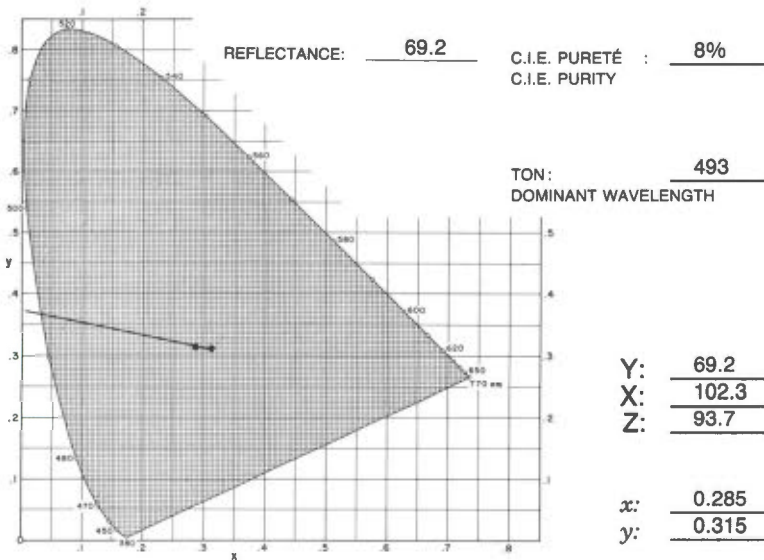

ID. PATCHES BLOCS IDEN.	% SCREEN TRAME	DENSITY DENSITÉ	% PRINT IMPRESSION
A	3	.08	3
B	6	.09	7
C	12	.10	12
D	22	.11	23
E	30	.13	34
F	40	.16	44
G	52	.18	59
H	66	.21	72
I	77	.23	80
J	87	.25	89
M	14	.10	15
N	27	.13	32
O	37	.15	44
P	51	.17	55
SOLID TEINTE PLATE	100	.27	100

PAPER - PAPIER

GRADE / CATÉGORIE: W.S. NEW BRITE

TYPE: UNCOATED - NON COUCHÉ

REFLECTIVITÉ / REFLECTIVITY: 85%

OPACITÉ / OPACITY: 85.5%

% CONTRASTE/CONTRAST: 15%

PLATE - PLAQUE

SUBT. - SOUST.

TYPE: NEGATIVE

PRESS - PRESSE

• MEIHLE

• UNIT(É) #: LOWER/INFÉRIEURE

The colour printed here was blended from, and should only be blended from PANTONE Basic Colours obtained from a PANTONE Licensed Printing Ink Manufacturer.
Pantone, Inc. assumes no responsibility for the accuracy of the formulas or the colour reproduced.

La couleur ci-imprimée fut et devrait être mélangée seulement à partir des couleurs de base PANTONE obtenues d'un fabricant d'encre autorisé.
La compagnie Pantone, Inc. n'assume aucune responsabilité quant à l'exactitude du mélange ou de la couleur obtenue.

RDD - DRD

COLOURS AND SCREENS

COULEURS ET TRAMES

.38mm

F

.13mm

BIANGULAR SCREENS — TRAMES BIANGULÉES

M

.08mm
.13mm
.18mm
.25mm
.38mm

N

.08mm
.13mm
.18mm
.25mm
.38mm

O

.08mm
.13mm
.18mm
.25mm
.38mm

P

.08mm
.13mm
.18mm
.25mm
.38mm

SOLID — TEINTE PLATE

8 pt. Triumvirate Roman/Romain
10 pt. Futura Roman/Romain
12 pt. CG Trade Condensed/Condensé

.08mm
.13mm
.18mm
.25mm
.38mm

A

B

C

D

E

F

G

H

I

J

S

TECHNICAL INFORMATION — DONNÉES TECHNIQUES

INK - ENCRE

PANTONE® * FORMUL (A/E)

COLOUR No. COULEUR : 4950-114

- .0550 parts Pantone Process Blue
- .0090 parts Pantone Process Yellow
- .0020 parts Pantone Mixing Black
- .9340 parts Pantone Extender

AIM SOLID DENSITY
DENSITÉ TEINTE PLATE VISÉE : 0.36 W/H 0.37 D/S

GRAYNESS - NETTETÉ : N/A

HUE ERROR - DÉVIATION DE : N/A
TEINTE

INK EFFICIENCY : N/A
EFFICACITÉ DE L'ENCRE

DENSITOMETRY / DENSITOMÉTRIE

- CHANNEL-SÉLECTION: CYAN
- FILTER TYPE DE FILTRES: STATUS T
- FACTEUR n FACTOR: 2.7

* Pantone, Inc.'s check-standard trademark for colour reproduction and colour reproduction materials.

* La marque de Pantone, Inc. de contrôle uniforme pour la reproduction en couleur et les matériaux pour la reproduction en couleur.

CIE CHROMATICITY DIAGRAM(ME) DES CHROMATICITÉS CIE

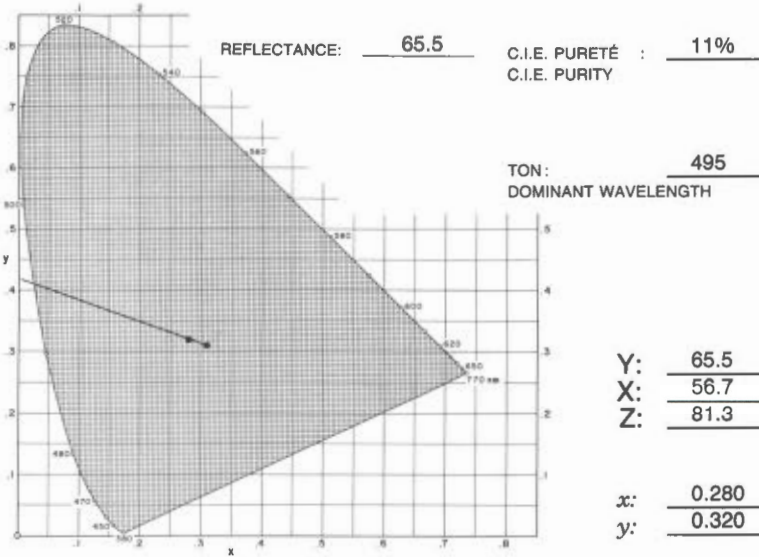

PAPER - PAPIER

GRADE / CATÉGORIE: W.S. STANDARD

TYPE: UNCOATED - NON COUCHÉ

REFLECTIVITÉ / REFLECTIVITY: 85%

OPACITÉ / OPACITY: 87%

% CONTRASTE/CONTRAST: 14%

PLATE - PLAQUE

TYPE: SUBT. - SOUST.

TYPE: NEGATIVE

PRESS - PRESSE

• MEIHLE

• UNIT(É) #: LOWER/INFÉRIEURE

ID. PATCHES BLOCS IDEN.	% SCREEN TRAME	DENSITY DENSITÉ	% PRINT IMPRESSION
A	3	.08	4
B	6	.09	9
C	12	.10	17
D	22	.14	27
E	30	.16	38
F	40	.19	49
G	52	.23	61
H	66	.26	74
I	77	.30	83
J	87	.31	91
M	14	.11	19
N	27	.15	39
O	37	.19	48
P	51	.22	58
SOLID TEINTE PLATE	100	.35	100

The colour printed here was blended from, and should only be blended from PANTONE Basic Colours obtained from a PANTONE Licensed Printing Ink Manufacturer. Pantone, Inc. assumes no responsibility for the accuracy of the formulas or the colour reproduced.

La couleur ci-imprimée fut et devrait être mélangée seulement à partir des couleurs de base PANTONE obtenues d'un fabricant d'encre autorisé. La compagnie Pantone, Inc. n'assume aucune responsabilité quant à l'exactitude du mélange ou de la couleur obtenue.

RDD - DRD

COLOURS AND SCREENS

COULEURS ET TRAMES



BIANGULAR SCREENS — TRAMES BIANGULÉES

M

- .08mm
- .13mm
- .18mm
- .25mm
- .38mm

N

- .08mm
- .13mm
- .18mm
- .25mm
- .38mm

O

- .08mm
- .13mm
- .18mm
- .25mm
- .38mm

P

- .08mm
- .13mm
- .18mm
- .25mm
- .38mm

SOLID — TEINTE PLATE

- 8 pt. Century Text Italic/Italique
- 8 pt. Triumvirate Roman/Romain
- 10 pt. Futura Roman/Romain
- 12 pt. CG Trade Condensed/Condensé

- .08mm
- .13mm
- .18mm
- .25mm
- .38mm

A

B

C

D

E

F

G

H

I

J

S

TECHNICAL INFORMATION — DONNÉES TECHNIQUES

INK - ENCRE

PANTONE® * FORMUL (A_E)

COLOUR No. COULEUR : 4950-114

- .0550 parts Pantone Process Blue
- .0090 parts Pantone Process Yellow
- .0020 parts Pantone Mixing Black
- .9340 parts Pantone Extender

AIM SOLID DENSITY
DENSITÉ TEINTE PLATE VISÉE : 0.36 W/H 0.35 D/S

GRAYNESS - NETTETÉ : N/A

HUE ERROR - DÉVIATION DE : N/A
TEINTE

INK EFFICIENCY : N/A
EFFICACITÉ DE L'ENCRE

DENSITOMETRY / DENSITOMÉTRIE

- CHANNEL-SÉLECTION: CYAN
- FILTER TYPE DE FILTRES: STATUS T
- FACTEUR n FACTOR: 2.7

* Pantone, Inc.'s check-standard trademark for colour reproduction and colour reproduction materials.
* La marque de Pantone, Inc. de contrôle uniforme pour la reproduction en couleur et les matériaux pour la reproduction en couleur.

CIE CHROMATICITY DIAGRAM(ME) DES CHROMATICITÉS CIE

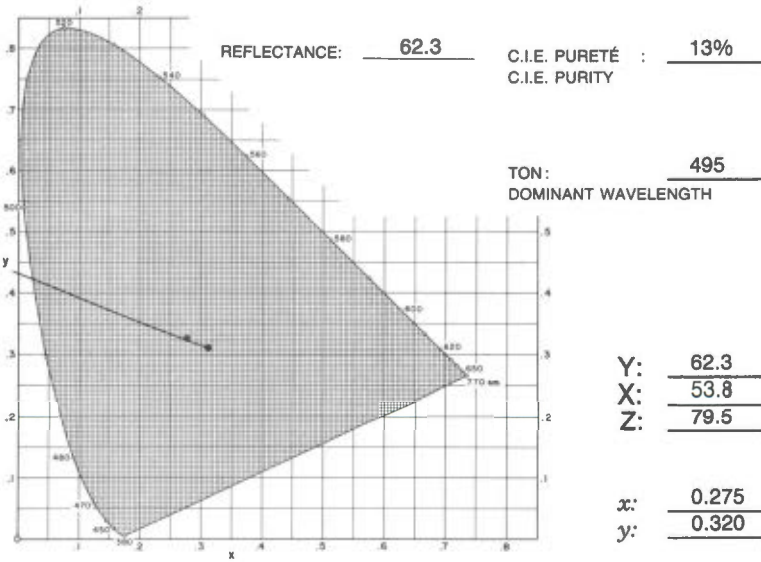

ID. PATCHES BLOCS IDEN.	% SCREEN TRAME	DENSITY DENSITÉ	% PRINT IMPRESSION
A	3	.09	3
B	6	.09	8
C	12	.11	15
D	22	.14	26
E	30	.16	36
F	40	.20	47
G	52	.23	58
H	66	.27	72
I	77	.29	82
J	87	.31	87
M	14	.12	19
N	27	.16	33
O	37	.19	45
P	51	.23	60
SOLID TEINTE PLATE	100	.35	100

PAPER - PAPIER

GRADE / CATÉGORIE: W.S. NEW BRITE

TYPE: UNCOATED - NON COUCHÉ

REFLECTIVITÉ / REFLECTIVITY: 85%

OPACITÉ / OPACITY: 85.5%

% CONTRASTE/CONTRAST: 17%

PLATE - PLAQUE

SUBT. - SOUST.

TYPE: NEGATIVE

PRESS - PRESSE

• MEIHLE

• UNIT(É) #: LOWER/INFÉRIEURE

The colour printed here was blended from, and should only be blended from PANTONE Basic Colours obtained from a PANTONE Licensed Printing Ink Manufacturer.
Pantone, Inc. assumes no responsibility for the accuracy of the formulas or the colour reproduced.

La couleur ci-imprimée fut et devrait être mélangée seulement à partir des couleurs de base PANTONE obtenues d'un fabricant d'encre autorisé.
La compagnie Pantone, Inc. n'assume aucune responsabilité quant à l'exactitude du mélange ou de la couleur obtenue.

RDD - DRD

COLOURS AND SCREENS

COULEURS ET TRAMES



BIANGULAR SCREENS — TRAMES BIANGULÉES

M

.06mm
.13mm
.18mm
.25mm
.38mm

N

.06mm
.13mm
.18mm
.25mm
.38mm

O

.06mm
.13mm
.18mm
.25mm
.38mm

P

.06mm
.13mm
.18mm
.25mm
.38mm

SOLID — TEINTE PLATE

8 pt. Century Text *italic/Italique*
8 pt. Triumvirate Roman/Romain
10 pt. Futura Roman/Romain
12 pt. CG Trade Condensed/Condensé

.06mm
.13mm
.18mm
.25mm
.38mm

A

B

C

D

E

F

G

H

I

J

S

TECHNICAL INFORMATION — DONNÉES TECHNIQUES

INK - ENCRE

PANTONE® * FORMUL (A/E)

COLOUR No. COULEUR : 4950-114

- ___ .0550 parts Pantone Process Blue
- ___ .0090 parts Pantone Process Yellow
- ___ .0020 parts Pantone Mixing Black
- ___ .9340 parts Pantone Extender

AIM SOLID DENSITY
DENSITÉ TEINTE PLATE VISÉE : 0.37 W/H 0.39 D/S

GRAYNESS - NETTETÉ : N/A

HUE ERROR - DÉVIATION DE : N/A
TEINTE

INK EFFICIENCY : N/A
EFFICACITÉ DE L'ENCRE

DENSITOMETRY / DENSITOMÉTRIE

- CHANNEL-SÉLECTION: CYAN
- FILTER TYPE DE FILTRES: STATUS T
- FACTEUR n FACTOR: 2.7

* Pantone, Inc.'s check-standard trademark for colour reproduction and colour reproduction materials.

* La marque de Pantone, Inc. de contrôle uniforme pour la reproduction en couleur et les matériaux pour la reproduction en couleur.

CIE CHROMATICITY DIAGRAM(ME) DES CHROMATICITÉS CIE

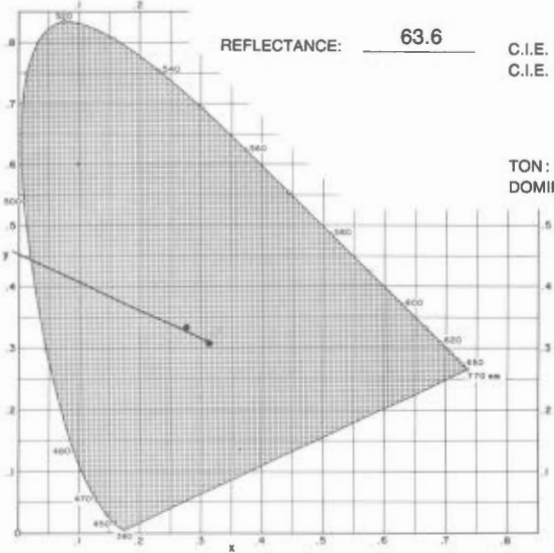

REFLECTANCE: 63.6 C.I.E. PURETÉ : 12%
C.I.E. PURITY

TON: 495
DOMINANT WAVELENGTH

Y: 63.6
X: 53.9
Z: 77.2

x: 0.275
y: 0.325

PAPER - PAPIER

PLATE - PLAQUE

GRADE / CATÉGORIE: CHART

SUBT. - SOUST.

TYPE: UNCOATED - NON COUCHÉ

TYPE: NEGATIVE

REFLECTIVITÉ / REFLECTIVITY: 87%

PRESS - PRESSE

OPACITÉ / OPACITY: 96.5%

• MEIHLE

% CONTRASTE/CONTRAST: 19%

• UNIT(É) #: LOWER/INFÉRIEURE

ID. PATCHES BLOCS IDEN.	% SCREEN TRAME	DENSITY DENSITÉ	% PRINT IMPRESSION
A	3	.07	4
B	6	.08	8
C	12	.10	15
D	22	.12	25
E	30	.15	35
F	40	.19	46
G	52	.22	59
H	66	.26	72
I	77	.29	80
J	87	.32	89
M	14	.11	20
N	27	.15	36
O	37	.19	46
P	51	.22	57
SOLID TEINTE PLATE	100	.36	100

The colour printed here was blended from, and should only be blended from PANTONE Basic Colours obtained from a PANTONE Licensed Printing Ink Manufacturer. Pantone, Inc. assumes no responsibility for the accuracy of the formulas or the colour reproduced.

La couleur ci-imprimée fut et devrait être mélangée seulement à partir des couleurs de base PANTONE obtenues d'un fabricant d'encre autorisé. La compagnie Pantone, Inc. n'assume aucune responsabilité quant à l'exactitude du mélange ou de la couleur obtenue.

RDD - DRD

COLOURS AND SCREENS

COULEURS ET TRAMES

.38mm

F

.13mm

BIANGULAR SCREENS — TRAMES BIANGULÉES

M

.08mm
.13mm
.18mm
.25mm
.38mm

N

.08mm
.13mm
.18mm
.25mm
.38mm

O

.08mm
.13mm
.18mm
.25mm
.38mm

P

.08mm
.13mm
.18mm
.25mm
.38mm

SOLID — TEINTE PLATE

8 pt. Traumatic Roman/Romain
10 pt. Futura Roman/Romain
12 pt. CO Trade Condensed/Condensé

.08mm
.13mm
.18mm
.25mm
.38mm

A

B

C

D

E

F

G

H

I

J

S

TECHNICAL INFORMATION — DONNÉES TECHNIQUES

INK - ENCRE

PANTONE® * FORMUL (A/E)

COLOUR No. COULEUR : 5160-144

AIM SOLID DENSITY
DENSITÉ TEINTE PLATE VISÉE : 0.88 W/H 0.81 D/S

GRAYNESS - NETTETÉ : N/A

HUE ERROR - DÉVIATION DE : N/A
TEINTE

INK EFFICIENCY : N/A
EFFICACITÉ DE L'ENCRE

DENSITOMETRY / DENSITOMÉTRIE

• CHANNEL-SÉLECTION: CYAN

• FILTER TYPE DE FILTRES: STATUS T

• FACTEUR n FACTOR: 2.7

* Pantone, Inc.'s check-standard trademark for colour reproduction and colour reproduction materials.
* La marque de Pantone, Inc. de contrôle uniforme pour la reproduction en couleur et les matériaux pour la reproduction en couleur.

CIE CHROMATICITY DIAGRAM(ME) DES CHROMATICITÉS CIE

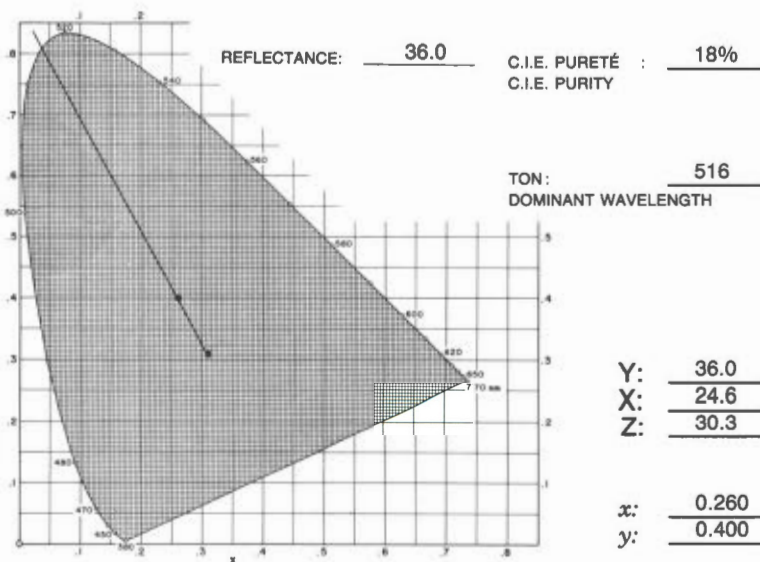

ID. PATCHES BLOCS IDEN.	% SCREEN FRAME	DENSITY DENSITÉ	% PRINT IMPRESSION
A	3	.09	6
B	6	.11	10
C	12	.16	18
D	22	.22	29
E	30	.28	40
F	40	.36	51
G	52	.43	62
H	66	.52	74
I	77	.60	84
J	87	.66	90
M	14	.18	22
N	27	.28	39
O	37	.34	49
P	51	.41	61
SOLID TEINTE PLATE	100	.73	100

PAPER - PAPIER

PLATE - PLAQUE

GRADE / CATÉGORIE: W.S. STANDARD

SUBT. - SOUST.

TYPE: UNCOATED - NON COUCHÉ

TYPE: NEGATIVE

REFLECTIVITÉ / REFLECTIVITY: 89%

PRESS - PRESSE

OPACITÉ / OPACITY: 87%

• MEIHLE

% CONTRASTE/CONTRAST: 26%

• UNIT(É) #: LOWER/INFÉRIEURE

The colour printed here was blended from, and should only be blended from PANTONE Basic Colours obtained from a PANTONE Licensed Printing Ink Manufacturer.
Pantone, Inc. assumes no responsibility for the accuracy of the formulas or the colour reproduced.

La couleur ci-imprimée fut et devrait être mélangée seulement à partir des couleurs de base PANTONE obtenues d'un fabricant d'encre autorisé.
La compagnie Pantone, Inc. n'assume aucune responsabilité quant à l'exactitude du mélange ou de la couleur obtenue.

RDD - DRD

COLOURS AND SCREENS

COULEURS ET TRAMES

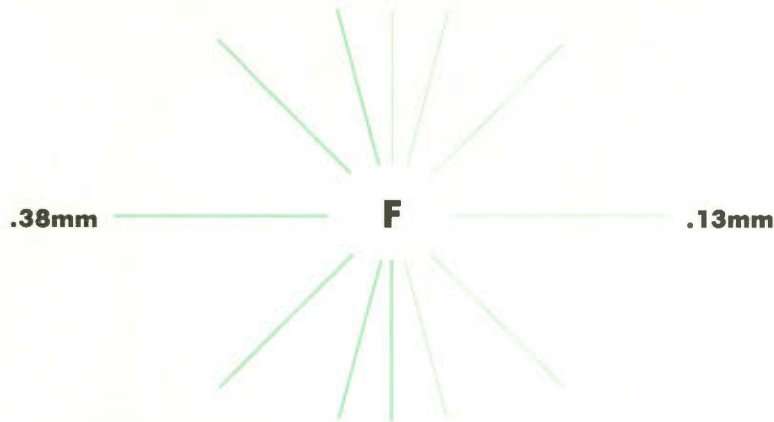

BIANGULAR SCREENS — TRAMES BIANGULÉES

M

6 pt. *Triumvirate Roman/Romain*
8 pt. *Triumvirate Roman/Romain*
10 pt. *Futura Roman/Romain*
12 pt. *CG Trade Condensed/Condensé*



N

6 pt. *Triumvirate Roman/Romain*
8 pt. *Futura Roman/Romain*
10 pt. *CG Trade Condensed/Condensé*
12 pt. *Cent. Text It./Italique*



O

6 pt. *Futura Roman/Romain*
8 pt. *CG Trade Condensed/Condensé*
10 pt. *Century Text Italic/Italique*
12 pt. *Trium. Rom./Romain*



P

6 pt. *CG Trade Condensed/Condensé*
8 pt. *Century Text Italic/Italique*
10 pt. *Triumvirate Roman/Romain*
12 pt. *Futura Roman/Romain*



SOLID — TEINTE PLATE

6 pt. *Century Text Italic/Italique*
8 pt. *Triumvirate Roman/Romain*
10 pt. *Futura Roman/Romain*
12 pt. *CG Trade Condensed/Condensé*



A

B

C

D

E

F

G

H

I

J

S

TECHNICAL INFORMATION — DONNÉES TECHNIQUES

INK - ENCRE

PANTONE® * FORMUL (A/E)

COLOUR No. COULEUR : 5160-144

AIM SOLID DENSITY
DENSITÉ TEINTE PLATE VISÉE : 0.90 W/H 0.85 D/S

GRAYNESS - NETTETÉ : N/A

HUE ERROR - DÉVIATION DE : N/A
TEINTE

INK EFFICIENCY : N/A
EFFICACITÉ DE L'ENCRE

DENSITOMETRY / DENSITOMÉTRIE

- CHANNEL-SÉLECTION: CYAN
- FILTER TYPE DE FILTRES: STATUS T
- FACTEUR n FACTOR: 2.7

* Pantone, Inc.'s check-standard trademark for colour reproduction and colour reproduction materials.

* La marque de Pantone, Inc. de contrôle uniforme pour la reproduction en couleur et les matériaux pour la reproduction en couleur.

CIE CHROMATICITY DIAGRAM(ME) DES CHROMATICITÉS CIE

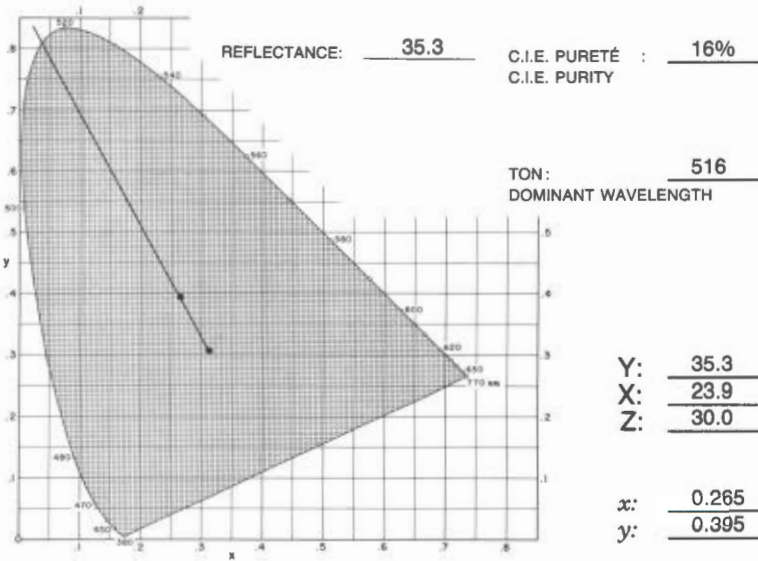

PAPER - PAPIER

GRADE / CATÉGORIE: W.S. NEW BRITE

TYPE: UNCOATED - NON COUCHÉ

REFLECTIVITÉ / REFLECTIVITY: 83%

OPACITÉ / OPACITY: 85.5%

% CONTRASTE/CONTRAST: 28%

PLATE - PLAQUE

TYPE: SUBT. - SOUST.

TYPE: NEGATIVE

PRESS - PRESSE

• MEIHLE

• UNIT(É) #: LOWER/INFÉRIEURE

ID. PATCHES BLOCS IDEN.	% SCREEN TRAME	DENSITY DENSITÉ	% PRINT IMPRESSION
A	3	.09	6
B	6	.12	11
C	12	.17	18
D	22	.23	30
E	30	.29	39
F	40	.36	50
G	52	.42	60
H	66	.52	70
I	77	.61	84
J	87	.64	90
M	14	.19	22
N	27	.29	40
O	37	.34	48
P	51	.42	59
SOLID TEINTE PLATE	100	.75	100

The colour printed here was blended from, and should only be blended from PANTONE Basic Colours obtained from a PANTONE Licensed Printing Ink Manufacturer. Pantone, Inc. assumes no responsibility for the accuracy of the formulas or the colour reproduced.

La couleur ci-imprimée fut et devrait être mélangée seulement à partir des couleurs de base PANTONE obtenues d'un manufacturier d'encre autorisé. La compagnie Pantone, Inc. n'assume aucune responsabilité quant à l'exactitude du mélange ou de la couleur obtenue.

RDD - DRD

COLOURS AND SCREENS

COULEURS ET TRAMES

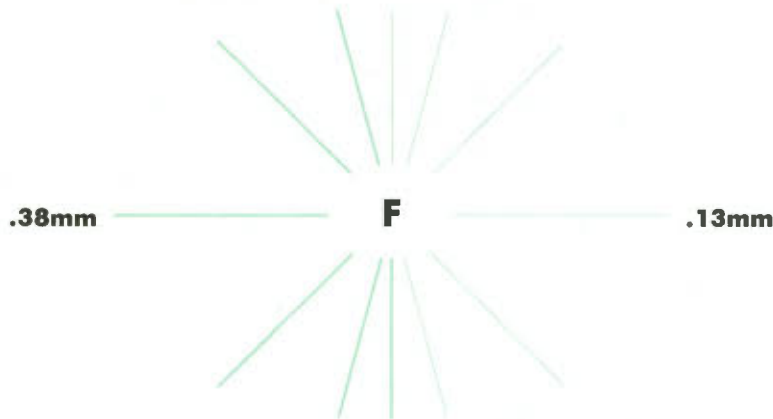

BIANGULAR SCREENS — TRAMES BIANGULÉES

M

6 pt. Triumvirate Roman/Romain	.06mm	
8 pt. Triumvirate Roman/Romain	.13mm	
10 pt. Futura Roman/Romain	.18mm	
12 pt. CG Trade Condensed/Condensé	.25mm	
	.38mm	

N

6 pt. Triumvirate Roman/Romain	.06mm	
8 pt. Futura Roman/Romain	.13mm	
10 pt. CG Trade Condensed/Condensé	.18mm	
12 pt. Cent. Text It./Italique	.25mm	
	.38mm	

O

6 pt. Futura Roman/Romain	.06mm	
8 pt. CG Trade Condensed/Condensé	.13mm	
10 pt. Century Text Italic/Italique	.18mm	
12 pt. Trium. Rom./Romain	.25mm	
	.38mm	

P

6 pt. CG Trade Condensed/Condensé	.06mm	
8 pt. Century Text Italic/Italique	.13mm	
10 pt. Triumvirate Roman/Romain	.18mm	
12 pt. Futura Roman/Romain	.25mm	
	.38mm	

SOLID — TEINTE PLATE

6 pt. Century Text Italic/Italique	.06mm	
8 pt. Triumvirate Roman/Romain	.13mm	
10 pt. Futura Roman/Romain	.18mm	
12 pt. CG Trade Condensed/Condensé	.25mm	
	.38mm	

A

B

C

D

E

F

G

H

I

J

S

TECHNICAL INFORMATION — DONNÉES TECHNIQUES

INK - ENCRE

PANTONE® * FORMUL (A)
(E)

COLOUR No. COULEUR : 5160-144

AIM SOLID DENSITY
DENSITÉ TEINTE PLATE VISÉE : 0.89 W/H 0.85 D/S

GRAYNESS - NETTETÉ : N/A

HUE ERROR - DÉVIATION DE : N/A
TEINTE

INK EFFICIENCY
EFFICACITÉ DE L'ENCRE : N/A

DENSITOMETRY / DENSITOMÉTRIE

- CHANNEL-SÉLECTION: CYAN
- FILTER TYPE DE FILTRES: STATUS T
- FACTEUR n FACTOR: 2.7

* Pantone, Inc.'s check-standard trademark for colour reproduction and colour reproduction materials.
* La marque de Pantone, Inc. de contrôle uniforme pour la reproduction en couleur et les matériaux pour la reproduction en couleur.

CIE CHROMATICITY DIAGRAM(ME) DES CHROMATICITÉS CIE

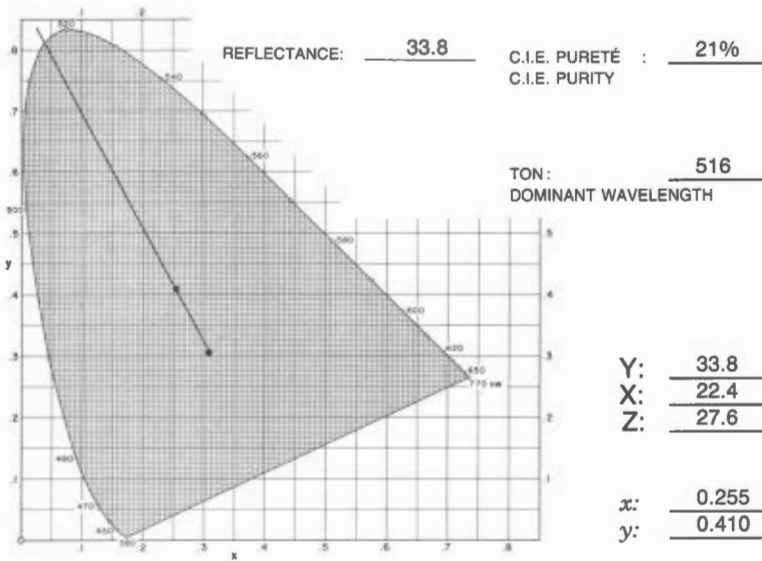

PAPER - PAPIER

PLATE - PLAQUE

GRADE / CATÉGORIE: CHART

SUBT. - SOUST.

TYPE: UNCOATED - NON COUCHÉ

TYPE: NEGATIVE

REFLECTIVITÉ / REFLECTIVITY: 89%

PRESS - PRESSE

OPACITÉ / OPACITY: 96.5%

• MEIHLE

% CONTRASTE/CONTRAST: 26%

• UNIT(É) #: LOWER/INFÉRIEURE

ID. PATCHES BLOCS IDEN.	% SCREEN TRAME	DENSITY DENSITE	% PRINT IMPRESSION
A	3	.08	5
B	6	.10	9
C	12	.14	16
D	22	.21	26
E	30	.27	36
F	40	.34	48
G	52	.42	57
H	66	.53	72
I	77	.63	81
J	87	.70	90
M	14	.17	21
N	27	.27	37
O	37	.34	47
P	51	.43	58
SOLID TEINTE PLATE	100	.80	100

The colour printed here was blended from, and should only be blended from PANTONE Basic Colours obtained from a PANTONE Licensed Printing Ink Manufacturer. Pantone, Inc. assumes no responsibility for the accuracy of the formulas or the colour reproduced.

La couleur ci-imprimée fut et devrait être mélangée seulement à partir des couleurs de base PANTONE obtenues d'un manufacturier d'encre autorisé. La compagnie Pantone, Inc. n'assume aucune responsabilité quant à l'exactitude du mélange ou de la couleur obtenue.

RDD - DRD

COLOURS AND SCREENS

COULEURS ET TRAMES



BIANGULAR SCREENS — TRAMES BIANGULÉES

M

6 pt. Century Text Italic/Italique
8 pt. Futura Roman/Romain
10 pt. CG Trade Condensed/Condensé
12 pt. Triumvirate Roman/Romain

.08mm
.13mm
.18mm
.25mm
.38mm



N

6 pt. Century Text Italic/Italique
8 pt. Futura Roman/Romain
10 pt. CG Trade Condensed/Condensé
12 pt. Cent. Text Italic/Italique

.08mm
.13mm
.18mm
.25mm
.38mm



O

6 pt. Futura Roman/Romain
8 pt. CG Trade Condensed/Condensé
10 pt. Century Text Italic/Italique
12 pt. Triumvirate Roman/Romain

.08mm
.13mm
.18mm
.25mm
.38mm



P

6 pt. CG Trade Condensed/Condensé
8 pt. Century Text Italic/Italique
10 pt. Triumvirate Roman/Romain
12 pt. Futura Roman/Romain

.08mm
.13mm
.18mm
.25mm
.38mm



SOLID — TEINTE PLATE

6 pt. Century Text Italic/Italique
8 pt. Triumvirate Roman/Romain
10 pt. Futura Roman/Romain
12 pt. CG Trade Condensed/Condensé

.08mm
.13mm
.18mm
.25mm
.38mm



A

B

C

D

E

F

G

H

I

J

S

TECHNICAL INFORMATION — DONNÉES TECHNIQUES

INK - ENCRE

PANTONE® * FORMUL (A/E)

COLOUR No. COULEUR : 5230-347

AIM SOLID DENSITY
DENSITÉ TEINTE PLATE VISÉE : 0.86 W/H 0.82 D/S

GRAYNESS - NETTETÉ : N/A

HUE ERROR - DÉVIATION DE : N/A
TEINTE

INK EFFICIENCY : N/A
EFFICACITÉ DE L'ENCRE

DENSITOMETRY / DENSITOMÉTRIE

- CHANNEL-SÉLECTION: CYAN
- FILTER TYPE DE FILTRES: STATUS T
- FACTEUR n FACTOR: 2.7

* Pantone, Inc.'s check-standard trademark for colour reproduction and colour reproduction materials.

* La marque de Pantone, Inc. de contrôle uniforme pour la reproduction en couleur et les matériaux pour la reproduction en couleur.

CIE CHROMATICITY DIAGRAM(ME) DES CHROMATICITÉS CIE

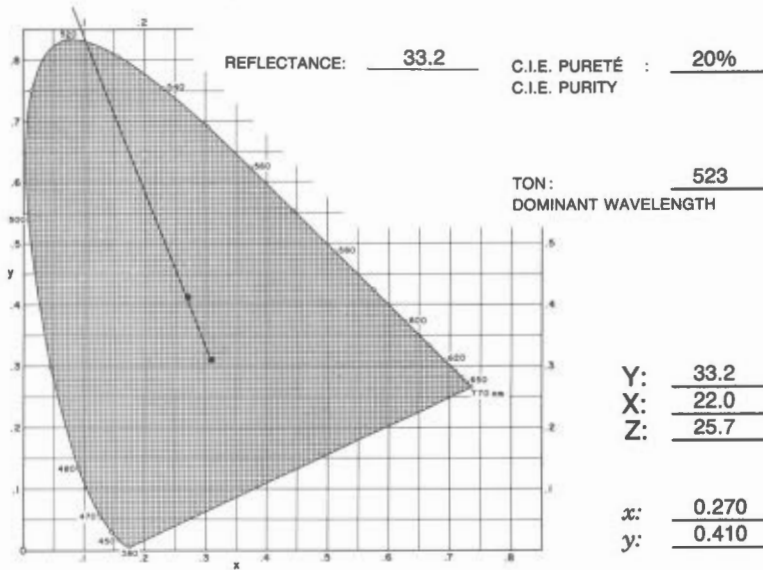

ID. PATCHES BLOCS IDEN.	% SCREEN TRAME	DENSITY DENSITÉ	% PRINT IMPRESSION
A	3	.09	5
B	6	.11	8
C	12	.15	16
D	22	.21	26
E	30	.29	38
F	40	.36	50
G	52	.44	59
H	66	.55	72
I	77	.65	83
J	87	.68	89
M	14	.17	19
N	27	.29	37
O	37	.36	47
P	51	.44	58
SOLID TEINTE PLATE	100	.78	100

PAPER - PAPIER

PLATE - PLAQUE

GRADE / CATÉGORIE: W.S. STANDARD

SUBT. - SOUST.

TYPE: UNCOATED - NON COUCHÉ

TYPE: NEGATIVE

REFLECTIVITÉ / REFLECTIVITY: 87%

PRESS - PRESSE

OPACITÉ / OPACITY: 87%

• MEIHLE

% CONTRASTE/CONTRAST: 21%

• UNIT(É) #: LOWER/INFÉRIEURE

The colour printed here was blended from, and should only be blended from PANTONE Basic Colours obtained from a PANTONE Licensed Printing Ink Manufacturer. Pantone, Inc. assumes no responsibility for the accuracy of the formulas or the colour reproduced.

La couleur ci-primée fut et devrait être mélangée seulement à partir des couleurs de base PANTONE obtenues d'un fabricant d'encre autorisé. La compagnie Pantone, Inc. n'assume aucune responsabilité quant à l'exactitude du mélange ou de la couleur obtenue.

RDD - DRD

COLOURS AND SCREENS

COULEURS ET TRAMES

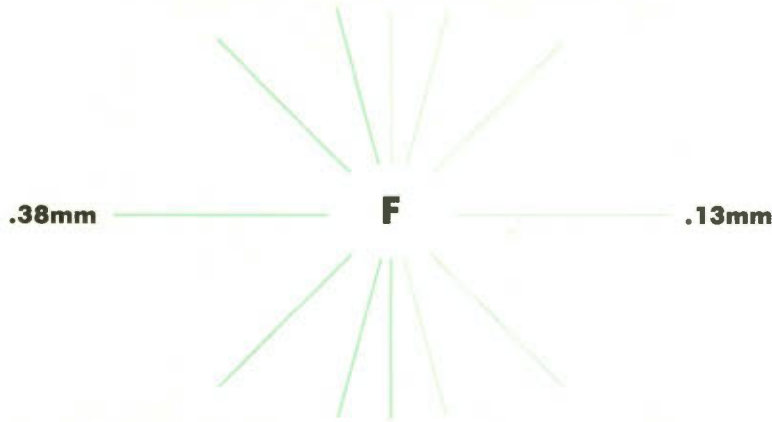

BIANGULAR SCREENS — TRAMES BIANGULÉES

M

1 pt. Triumvirate Roman/Romain	.06mm	
2 pt. Triumvirate Roman/Romain	.13mm	
10 pt. Futura Roman/Romain	.18mm	
12 pt. CG Trade Condensed/Condensé	.25mm	
	.38mm	

N

6 pt. Triumvirate Roman/Romain	.06mm	
8 pt. Futura Roman/Romain	.13mm	
10 pt. CG Trade Condensed/Condensé	.18mm	
12 pt. Cent. Text It/Italique	.25mm	
	.38mm	

O

6 pt. Futura Roman/Romain	.06mm	
8 pt. CG Trade Condensed/Condensé	.13mm	
10 pt. Century Text Italic/Italique	.18mm	
12 pt. Trium. Rom./Romain	.25mm	
	.38mm	

P

6 pt. CG Trade Condensed/Condensé	.06mm	
8 pt. Century Text Italic/Italique	.13mm	
10 pt. Triumvirate Roman/Romain	.18mm	
12 pt. Futura Roman/Romain	.25mm	
	.38mm	

SOLID — TEINTE PLATE

6 pt. Century Text Italic/Italique	.06mm	
8 pt. Triumvirate Roman/Romain	.13mm	
10 pt. Futura Roman/Romain	.18mm	
12 pt. CG Trade Condensed/Condensé	.25mm	
	.38mm	

A
B
C
D
E
F
G
H
I
J
S

TECHNICAL INFORMATION — DONNÉES TECHNIQUES

INK - ENCRE

PANTONE® * FORMUL (A/E)

COLOUR No. COULEUR : 5230-347

AIM SOLID DENSITY
DENSITÉ TEINTE PLATE VISÉE : 0.87 W/H 0.82 D/S

GRAYNESS - NETTÉTÉ : N/A

HUE ERROR - DÉVIATION DE : N/A
TEINTE

INK EFFICIENCY
EFFICACITÉ DE L'ENCRE : N/A

DENSITOMETRY / DENSITOMÉTRIE

• CHANNEL-SÉLECTION: CYAN

• FILTER TYPE DE FILTRES: STATUS T

• FACTEUR n FACTOR: 2.7

* Pantone, Inc.'s check-standard trademark for colour reproduction and colour reproduction materials.

* La marque de Pantone, Inc. de contrôle uniforme pour la reproduction en couleur et les matériaux pour la reproduction en couleur.

CIE CHROMATICITY DIAGRAM(ME) DES CHROMATICITÉS CIE

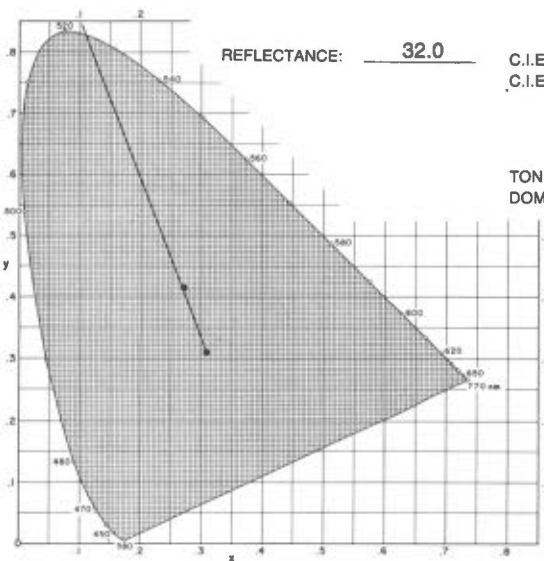

REFLECTANCE: 32.0 C.I.E. PURETÉ : 20%
C.I.E. PURITY

TON: 523
DOMINANT WAVELENGTH

Y: 32.0
X: 21.1
Z: 25.3

x: 0.270
y: 0.410

PAPER - PAPIER

GRADE / CATÉGORIE: W.S. NEW BRITE

TYPE: UNCOATED - NON COUCHÉ

REFLECTIVITÉ / REFLECTIVITY: 87%

OPACITÉ / OPACITY: 85.5%

% CONTRASTE/CONTRAST: 19%

PLATE - PLAQUE

SUBT. - SOUST.

TYPE: NEGATIVE

PRESS - PRESSE

• MEIHLE

• UNIT(É) #: LOWER/INFÉRIEURE

ID. PATCHES BLOCS IDEN.	% SCREEN TRAME	DENSITY DENSITÉ	% PRINT IMPRESSION
A	3	.09	4
B	6	.11	8
C	12	.16	16
D	22	.22	26
E	30	.28	37
F	40	.36	48
G	52	.44	60
H	66	.55	74
I	77	.66	87
J	87	.70	91
M	14	.18	19
N	27	.29	37
O	37	.34	47
P	51	.42	59
SOLID TEINTE PLATE	100	.78	100

The colour printed here was blended from, and should only be blended from PANTONE Basic Colours obtained from a PANTONE Licensed Printing Ink Manufacturer. Pantone, Inc. assumes no responsibility for the accuracy of the formulas or the colour reproduced.

La couleur ci-imprimée fut et devrait être mélangée seulement à partir des couleurs de base PANTONE obtenues d'un manufacturier d'encre autorisé. La compagnie Pantone, Inc. n'assume aucune responsabilité quant à l'exactitude du mélange ou de la couleur obtenue.

RDD - DRD

COLOURS AND SCREENS

COULEURS ET TRAMES

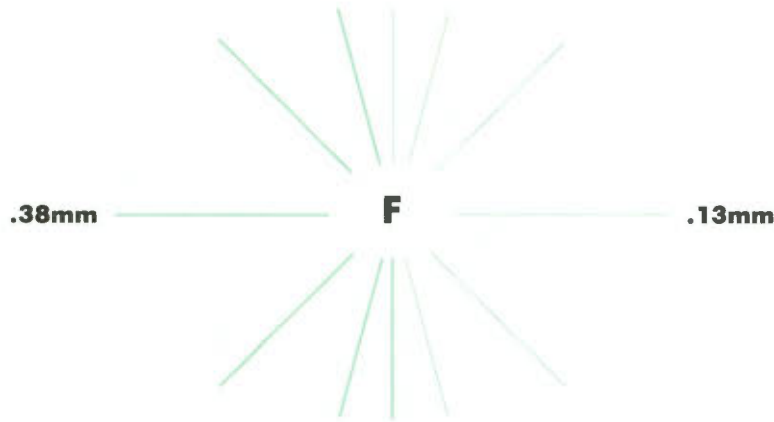

BIANGULAR SCREENS — TRAMES BIANGULÉES

M

6 pt. Triumvirate Roman/Romain	.08mm	
8 pt. Triumvirate Roman/Romain	.13mm	
10 pt. Futura Roman/Romain	.18mm	
12 pt. CG Trade Condensed/Condensé	.25mm	
	.38mm	

N

6 pt. Triumvirate Roman/Romain	.08mm	
8 pt. Futura Roman/Romain	.13mm	
10 pt. CG Trade Condensed/Condensé	.18mm	
12 pt. Cent. Text It./Italique	.25mm	
	.38mm	

O

6 pt. Futura Roman/Romain	.08mm	
8 pt. CG Trade Condensed/Condensé	.13mm	
10 pt. Century Text Italic/Italique	.18mm	
12 pt. Trium. Rom./Romain	.25mm	
	.38mm	

P

6 pt. CG Trade Condensed/Condensé	.08mm	
8 pt. Century Text Italic/Italique	.13mm	
10 pt. Triumvirate Roman/Romain	.18mm	
12 pt. Futura Roman/Romain	.25mm	
	.38mm	

SOLID — TEINTE PLATE

6 pt. Century Text Italic/Italique	.08mm	
8 pt. Triumvirate Roman/Romain	.13mm	
10 pt. Futura Roman/Romain	.18mm	
12 pt. CG Trade Condensed/Condensé	.25mm	
	.38mm	

A

B

C

D

E

F

G

H

I

J

S

TECHNICAL INFORMATION — DONNÉES TECHNIQUES

INK - ENCRE

PANTONE® * FORMUL (A/E)

COLOUR No. COULEUR : 5360-141

- .6400 parts Pantone Green
- .1600 parts Pantone Process Yellow
- .1600 parts Pantone Extender
- .0400 parts Pantone Process Blue

AIM SOLID DENSITY
DENSITÉ TEINTE PLATE VISÉE : 0.71 W/H 0.68 D/S

GRAYNESS - NETTETÉ : N/A

HUE ERROR - DÉVIATION DE : N/A
TEINTE

INK EFFICIENCY : N/A
EFFICACITÉ DE L'ENCRE

DENSITOMETRY / DENSITOMÉTRIE

- CHANNEL-SÉLECTION: CYAN
- FILTER TYPE DE FILTRES: STATUS T
- FACTEUR n FACTOR: 2.7

* Pantone, Inc.'s check-standard trademark for colour reproduction and colour reproduction materials.
* La marque de Pantone, Inc. de contrôle uniforme pour la reproduction en couleur et les matériaux pour la reproduction en couleur.

CIE CHROMATICITY DIAGRAM(ME) DES CHROMATICITÉS CIE

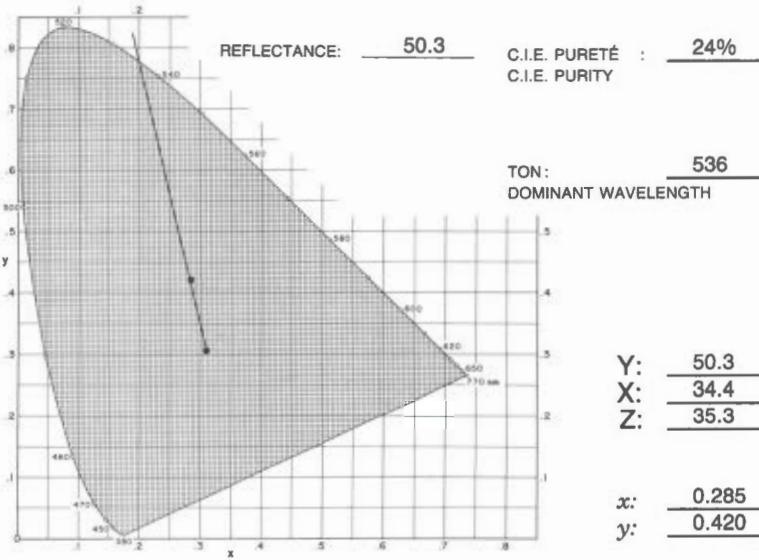

PAPER - PAPIER

GRADE / CATÉGORIE: W.S. STANDARD

TYPE: UNCOATED - NON COUCHÉ

REFLECTIVITÉ / REFLECTIVITY: 87%

OPACITÉ / OPACITY: 87%

% CONTRASTE/CONTRAST: 23%

PLATE - PLAQUE

TYPE: SUBT. - SOUST.

NEGATIVE

PRESS - PRESSE

• MEIHLE

• UNIT(É) #: LOWER/INFÉRIEURE

ID. PATCHES BLOCS IDEN.	% SCREEN TRAME	DENSITY DENSITÉ	% PRINT IMPRESSION
A	3	.08	6
B	6	.10	9
C	12	.14	16
D	22	.20	27
E	30	.24	38
F	40	.31	48
G	52	.37	61
H	66	.45	75
I	77	.52	82
J	87	.56	90
M	14	.16	20
N	27	.25	37
O	37	.30	47
P	51	.37	59
SOLID TEINTE PLATE	100	.64	100

The colour printed here was blended from, and should only be blended from PANTONE Basic Colours obtained from a PANTONE Licensed Printing Ink Manufacturer. Pantone, Inc. assumes no responsibility for the accuracy of the formulas or the colour reproduced.

La couleur ci-imprimée fut et devrait être mélangée seulement à partir des couleurs de base PANTONE obtenues d'un fabricant d'encre autorisé. La compagnie Pantone, Inc. n'assume aucune responsabilité quant à l'exactitude du mélange ou de la couleur obtenue.

RDD - DRD

COLOURS AND SCREENS

COULEURS ET TRAMES

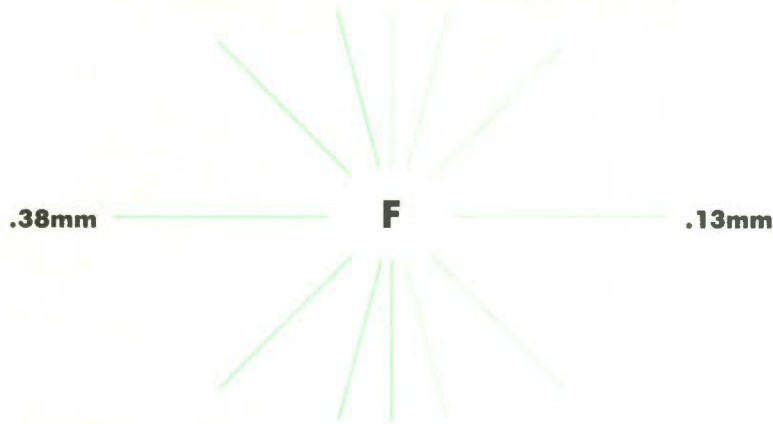

BIANGULAR SCREENS — TRAMES BIANGULÉES

M

6 pt. Century Text Italic/Italique	.06mm	
8 pt. Triumvirate Roman/Romain	.13mm	
10 pt. Futura Roman/Romain	.18mm	
12 pt. CG Trade Condensed/Condensé	.25mm	
	.38mm	

N

6 pt. Triumvirate Roman/Romain	.06mm	
8 pt. Futura Roman/Romain	.13mm	
10 pt. CG Trade Condensed/Condensé	.18mm	
12 pt. Cent. Text It/Italique	.25mm	
	.38mm	

O

6 pt. Futura Roman/Romain	.06mm	
8 pt. CG Trade Condensed/Condensé	.13mm	
10 pt. Century Text Italic/Italique	.18mm	
12 pt. Trium. Rom./Romain	.25mm	
	.38mm	

P

6 pt. CG Trade Condensed/Condensé	.06mm	
8 pt. Century Text Italic/Italique	.13mm	
10 pt. Triumvirate Roman/Romain	.18mm	
12 pt. Futura Roman/Romain	.25mm	
	.38mm	

SOLID — TEINTE PLATE

6 pt. Century Text Italic/Italique	.06mm	
8 pt. Triumvirate Roman/Romain	.13mm	
10 pt. Futura Roman/Romain	.18mm	
12 pt. CG Trade Condensed/Condensé	.25mm	
	.38mm	

A

B

C

D

E

F

G

H

I

J

S

TECHNICAL INFORMATION — DONNÉES TECHNIQUES

INK - ENCRE

PANTONE® * FORMUL (A)
(E)

COLOUR No. COULEUR : 5360-141

- .6400 parts Pantone Green
- .1600 parts Pantone Process Yellow
- .1600 parts Pantone Extender
- .0400 parts Pantone Process Blue

AIM SOLID DENSITY
DENSITÉ TEINTE PLATE VISÉE : 0.68 W/H 0.64 D/S

GRAYNESS - NETTETÉ : N/A

HUE ERROR - DÉVIATION DE : N/A
TEINTE

INK EFFICIENCY
EFFICACITÉ DE L'ENCRE : N/A

DENSITOMETRY / DENSITOMÉTRIE

- CHANNEL-SÉLECTION: CYAN
- FILTER TYPE DE FILTRES: STATUS T
- FACTEUR n FACTOR: 2.7

* Pantone, Inc.'s check-standard trademark for colour reproduction and colour reproduction materials.
* La marque de Pantone, Inc. de contrôle uniforme pour la reproduction en couleur et les matériaux pour la reproduction en couleur.

CIE CHROMATICITY DIAGRAM(ME) DES CHROMATICITÉS CIE

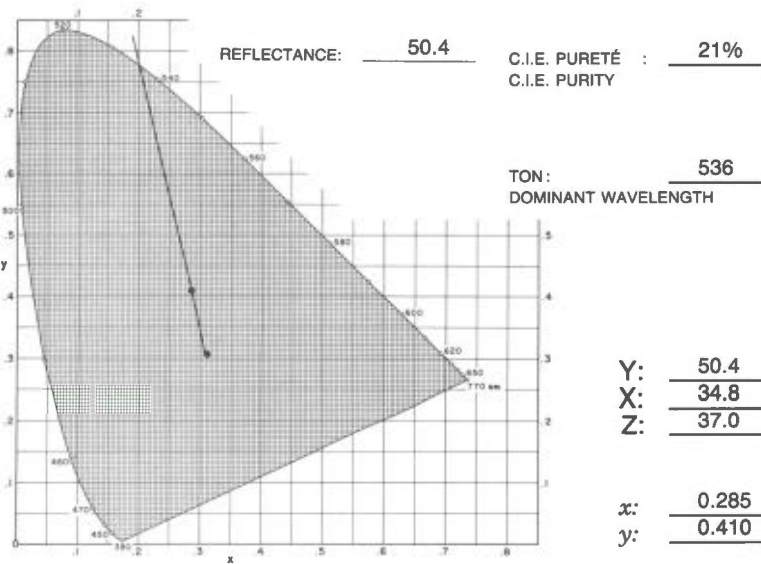

PAPER - PAPIER

GRADE / CATÉGORIE: W.S. NEW BRITE

TYPE: UNCOATED - NON COUCHÉ

REFLECTIVITÉ / REFLECTIVITY: 87%

OPACITÉ / OPACITY: 85.5%

% CONTRASTE/CONTRAST: 28%

PLATE - PLAQUE

SUBT. : SOUST.

TYPE: NEGATIVE

PRESS - PRESSE

• MEIHLE

• UNIT(É) #: LOWER/INFÉRIEURE

ID. PATCHES BLOCS IDEN.	% SCREEN TRAME	DENSITY DENSITÉ	% PRINT IMPRESSION
A	3	.08	4
B	6	.10	9
C	12	.14	16
D	22	.18	26
E	30	.22	35
F	40	.28	45
G	52	.34	57
H	66	.41	70
I	77	.46	79
J	87	.52	89
M	14	.15	19
N	27	.23	36
O	37	.28	45
P	51	.34	59
SOLID TEINTE PLATE	100	.60	100

The colour printed here was blended from, and should only be blended from PANTONE Basic Colours obtained from a PANTONE Licensed Printing Ink Manufacturer.
Pantone, Inc. assumes no responsibility for the accuracy of the formulas or the colour reproduced.

La couleur ci-imprimée fut et devrait être mélangée seulement à partir des couleurs de base PANTONE obtenues d'un manufacturier d'encre autorisé.
La compagnie Pantone, Inc. n'assume aucune responsabilité quant à l'exactitude du mélange ou de la couleur obtenue.

RDD - DRD

COLOURS AND SCREENS

COULEURS ET TRAMES

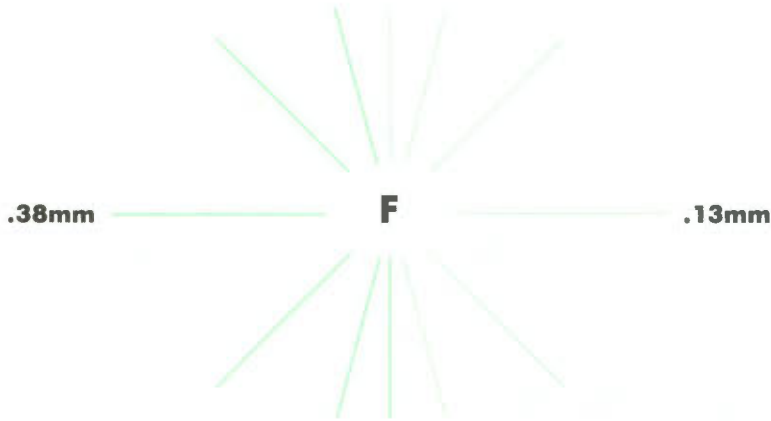

BIANGULAR SCREENS — TRAMES BIANGULÉES

M

6 pt. Triumvirate Roman/Romain	.08mm	
8 pt. Futura Roman/Romain	.13mm	
10 pt. Futura Roman/Romain	.18mm	
12 pt. CG Trade Condensed/Condensé	.25mm	
	.38mm	

N

6 pt. Triumvirate Roman/Romain	.08mm	
8 pt. Futura Roman/Romain	.13mm	
10 pt. CG Trade Condensed/Condensé	.18mm	
12 pt. Cent. Text It./Italique	.25mm	
	.38mm	

O

6 pt. Futura Roman/Romain	.08mm	
8 pt. CG Trade Condensed/Condensé	.13mm	
10 pt. Century Text It./Italique	.18mm	
12 pt. Trium. Rom./Romain	.25mm	
	.38mm	

P

6 pt. CG Trade Condensed/Condensé	.08mm	
8 pt. Century Text It./Italique	.13mm	
10 pt. Triumvirate Roman/Romain	.18mm	
12 pt. Futura Roman/Romain	.25mm	
	.38mm	

SOLID — TEINTE PLATE

6 pt. Century Text It./Italique	.08mm	
8 pt. Triumvirate Roman/Romain	.13mm	
10 pt. Futura Roman/Romain	.18mm	
12 pt. CG Trade Condensed/Condensé	.25mm	
	.38mm	

A

B

C

D

E

F

G

H

I

J

S

TECHNICAL INFORMATION — DONNÉES TECHNIQUES

INK - ENCRE

PANTONE® * FORMUL (A/E)

COLOUR No. COULEUR : 5510-5524

- .0700 parts Pantone Process Yellow
- .0280 parts Pantone Green
- .8390 parts Pantone Extender
- .0630 parts Pantone Process Blue

AIM SOLID DENSITY : 0.40 W/H 0.37 D/S
 DENSITÉ TEINTE PLATE VISÉE :

GRAYNESS - NETTETÉ : N/A

HUE ERROR - DÉVIATION DE : N/A
 TEINTE

INK EFFICIENCY : N/A
 EFFICACITÉ DE L'ENCRE

DENSITOMETRY / DENSITOMÉTRIE

- CHANNEL-SÉLECTION: CYAN
- FILTER TYPE DE FILTRES: STATUS T
- FACTEUR n FACTOR: 2.7

* Pantone, Inc.'s check-standard trademark for colour reproduction and colour reproduction materials.
 * La marque de Pantone, Inc. de contrôle uniforme pour la reproduction en couleur et les matériaux pour la reproduction en couleur.

CIE CHROMATICITY DIAGRAM(ME) DES CHROMATICITÉS CIE

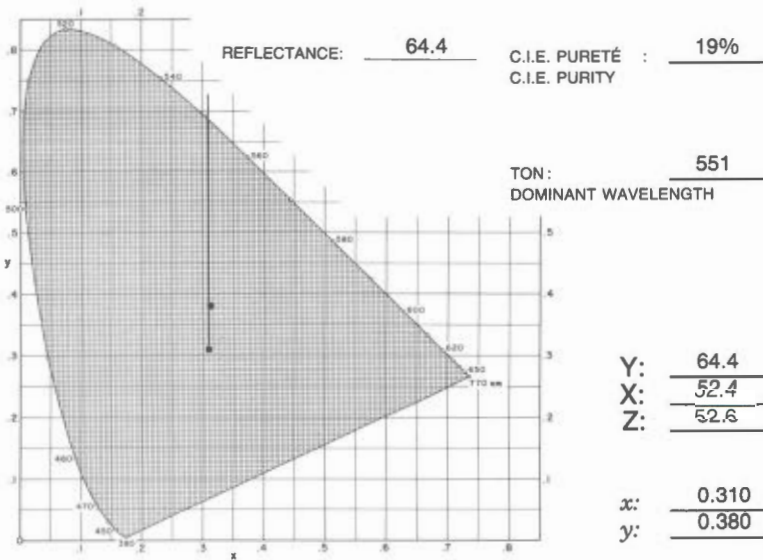

PAPER - PAPIER

PLATE - PLAQUE

GRADE / CATÉGORIE: W.S. STANDARD

SUBT. - SOUST.

TYPE: UNCOATED - NON COUCHÉ

TYPE: NEGATIVE

REFLECTIVITÉ / REFLECTIVITY: 87%

PRESS - PRESSE

OPACITÉ / OPACITY: 87%

• MEIHLE

% CONTRASTE/CONTRAST: 24%

• UNIT(É) #: LOWER/INFÉRIEURE

ID. PATCHES BLOCS IDEN.	% SCREEN TRAME	DENSITY DENSITÉ	% PRINT IMPRESSION
A	3	.06	2
B	6	.08	5
C	12	.10	16
D	22	.12	25
E	30	.15	33
F	40	.18	45
G	52	.21	57
H	66	.25	72
I	77	.28	79
J	87	.29	88
M	14	.10	12
N	27	.15	34
O	37	.16	40
P	51	.20	49
SOLID TEINTE PLATE	100	.32	100

The colour printed here was blended from, and should only be blended from PANTONE Basic Colours obtained from a PANTONE Licensed Printing Ink Manufacturer.
 Pantone, Inc. assumes no responsibility for the accuracy of the formulas or the colour reproduced.

La couleur ci-imprimée fut et devrait être mélangée seulement à partir des couleurs de base PANTONE obtenues d'un fabricant d'encre autorisé.
 La compagnie Pantone, Inc. n'assume aucune responsabilité quant à l'exactitude du mélange ou de la couleur obtenue.

RDD - DRD

COLOURS AND SCREENS

COULEURS ET TRAMES

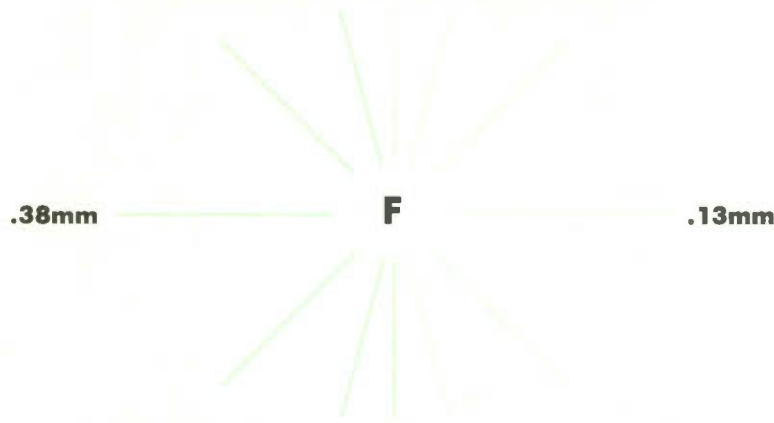

BIANGULAR SCREENS — TRAMES BIANGULÉES

M

4 pt. Century Text <i>Italo/Italique</i>	.08mm	
8 pt. Futura Roman/Romain	.13mm	
10 pt. Futura Roman/Romain	.18mm	
12 pt. CG Trade Condensed/Condensé	.25mm	
12 pt. CG Trade Condensed/Condensé	.38mm	

N

4 pt. Century Text <i>Italo/Italique</i>	.08mm	
8 pt. Futura Roman/Romain	.13mm	
10 pt. Futura Roman/Romain	.18mm	
12 pt. Cent. Text <i>Italo/Italique</i>	.25mm	
12 pt. Cent. Text <i>Italo/Italique</i>	.38mm	

O

4 pt. Century Text <i>Italo/Italique</i>	.08mm	
8 pt. CG Trade Condensed/Condensé	.13mm	
10 pt. Century Text <i>Italo/Italique</i>	.18mm	
12 pt. Trium. Rom./Romain	.25mm	
12 pt. Trium. Rom./Romain	.38mm	

P

4 pt. CG Trade Condensed/Condensé	.08mm	
8 pt. Century Text <i>Italo/Italique</i>	.13mm	
10 pt. Triumvirate Roman/Romain	.18mm	
12 pt. Futura Roman/Romain	.25mm	
12 pt. Futura Roman/Romain	.38mm	

SOLID — TEINTE PLATE

4 pt. Century Text <i>Italo/Italique</i>	.08mm	
8 pt. Triumvirate Roman/Romain	.13mm	
10 pt. Futura Roman/Romain	.18mm	
12 pt. CG Trade Condensed/Condensé	.25mm	
12 pt. CG Trade Condensed/Condensé	.38mm	

A
B
C
D
E
F
G
H
I
J
S

TECHNICAL INFORMATION — DONNÉES TECHNIQUES

INK - ENCRE

PANTONE® * FORMUL (A)_E

- .0700 parts Pantone Process Yellow
- .0280 parts Pantone Green
- .8390 parts Pantone Extender
- .0630 parts Pantone Process Blue

COLOUR No. COULEUR : 5510-5524

AIM SOLID DENSITY
DENSITÉ TEINTE PLATE VISÉE : 0.41 W/H 0.39 D/S

GRAYNESS - NETTETÉ : N/A

HUE ERROR - DÉVIATION DE : N/A
TEINTE

INK EFFICIENCY
EFFICACITÉ DE L'ENCRE : N/A

DENSITOMETRY / DENSITOMÉTRIE

- CHANNEL-SÉLECTION: CYAN
- FILTER TYPE DE FILTRES: STATUS T
- FACTEUR n FACTOR: 2.7

* Pantone, Inc.'s check-standard trademark for colour reproduction and colour reproduction materials.
* La marque de Pantone, Inc. de contrôle uniforme pour la reproduction en couleur et les matériaux pour la reproduction en couleur.

CIE CHROMATICITY DIAGRAM(ME) DES CHROMATICITÉS CIE

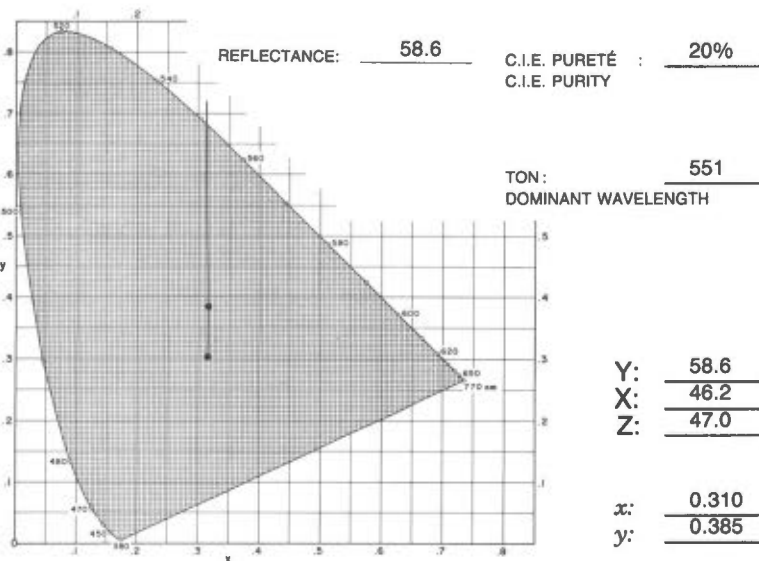

ID. PATCHES BLOCS IDEN.	% SCREEN TRAME	DENSITY DENSITÉ	% PRINT IMPRESSION
A	3	.08	3
B	6	.09	8
C	12	.10	14
D	22	.13	26
E	30	.16	36
F	40	.19	45
G	52	.24	60
H	66	.29	74
I	77	.31	85
J	87	.34	91
M	14	.11	16
N	27	.15	31
O	37	.19	45
P	51	.22	55
SOLID TEINTE PLATE	100	.37	100

PAPER - PAPIER

GRADE / CATÉGORIE: W.S. NEW BRITE

TYPE: UNCOATED - NON COUCHÉ

REFLECTIVITÉ / REFLECTIVITY: 87%

OPACITÉ / OPACITY: 85.5%

% CONTRASTE/CONTRAST: 20%

PLATE - PLAQUE

SUBT. - SOUST.

TYPE: NEGATIVE

PRESS - PRESSE

• MEIHLE

• UNIT(É) #: LOWER/INFÉRIEURE

The colour printed here was blended from, and should only be blended from PANTONE Basic Colours obtained from a PANTONE Licensed Printing Ink Manufacturer.
Pantone, Inc. assumes no responsibility for the accuracy of the formulas or the colour reproduced.

La couleur ci-imprimée fut et devrait être mélangée seulement à partir des couleurs de base PANTONE obtenues d'un fabricant d'encre autorisé.
La compagnie Pantone, Inc. n'assume aucune responsabilité quant à l'exactitude du mélange ou de la couleur obtenue.

RDD - DRD

COLOURS AND SCREENS

COULEURS ET TRAMES



BIANGULAR SCREENS — TRAMES BIANGULÉES

M

<i>6 pt. Century Text Italic/Italique</i>	.08mm	
<i>8 pt. Futura Roman/Romain</i>	.13mm	
<i>10 pt. Century Text Italic/Italique</i>	.18mm	
<i>14 pt. CG Trade Condensed/Condensé</i>	.25mm	
<i>18 pt. Century Text Italic/Italique</i>	.38mm	

N

<i>6 pt. Century Text Italic/Italique</i>	.08mm	
<i>8 pt. Futura Roman/Romain</i>	.13mm	
<i>10 pt. Century Text Italic/Italique</i>	.18mm	
<i>14 pt. CG Trade Condensed/Condensé</i>	.25mm	
<i>18 pt. Century Text Italic/Italique</i>	.38mm	

O

<i>6 pt. Century Text Italic/Italique</i>	.08mm	
<i>8 pt. Futura Roman/Romain</i>	.13mm	
<i>10 pt. Century Text Italic/Italique</i>	.18mm	
<i>12 pt. Triumvirate Roman/Romain</i>	.25mm	
	.38mm	

P

<i>6 pt. Century Text Italic/Italique</i>	.08mm	
<i>8 pt. Futura Roman/Romain</i>	.13mm	
<i>10 pt. Triumvirate Roman/Romain</i>	.18mm	
<i>12 pt. Futura Roman/Romain</i>	.25mm	
	.38mm	

SOLID — TEINTE PLATE

<i>6 pt. Century Text Italic/Italique</i>	.08mm	
<i>8 pt. Triumvirate Roman/Romain</i>	.13mm	
<i>10 pt. Futura Roman/Romain</i>	.18mm	
<i>12 pt. CG Trade Condensed/Condensé</i>	.25mm	
	.38mm	

A

B

C

D

E

F

G

H

I

J

S

TECHNICAL INFORMATION — DONNÉES TECHNIQUES

INK - ENCRE

PANTONE® * FORMUL (A)
E

COLOUR No. COULEUR : 5630-365

AIM SOLID DENSITY
DENSITÉ TEINTE PLATE VISÉE : 0.40 W/H 0.37 D/S

GRAYNESS - NETTETÉ : N/A

HUE ERROR - DÉVIATION DE : N/A
TEINTE

INK EFFICIENCY : N/A
EFFICACITÉ DE L'ENCRE

DENSITOMETRY / DENSITOMÉTRIE

• CHANNEL-SÉLECTION: YELLOW/JAUNE

• FILTER TYPE DE FILTRES: STATUS T

• FACTEUR n FACTOR: 2.7

* Pantone, Inc.'s check-standard trademark for colour reproduction and colour reproduction materials.

* La marque de Pantone, Inc. de contrôle uniforme pour la reproduction en couleur et les matériaux pour la reproduction en couleur.

CIE CHROMATICITY DIAGRAM(ME) DES CHROMATICITÉS CIE

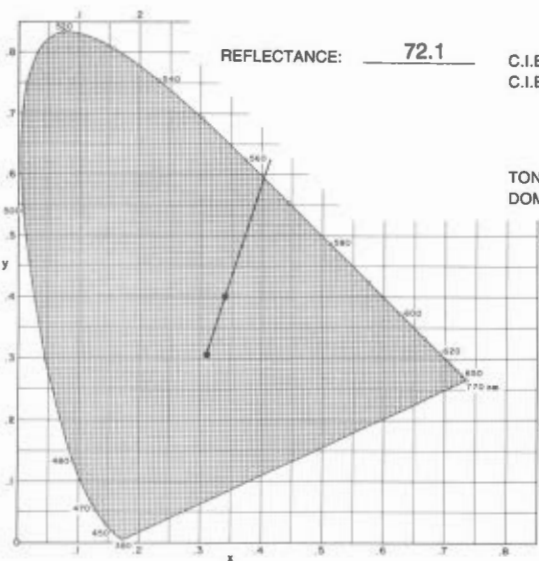

REFLECTANCE: 72.1 C.I.E. PURETÉ : 33%
C.I.E. PURITY

TON: 563
DOMINANT WAVELENGTH

Y: 72.1
X: 61.5
Z: 47.3

x: 0.340
y: 0.400

ID. PATCHES BLOCS IDEN.	% SCREEN FRAME	DENSITY DENSITÉ	% PRINT IMPRESSION
A	3	.10	3
B	6	.10	5
C	12	.12	12
D	22	.15	21
E	30	.18	29
F	40	.21	42
G	52	.25	53
H	66	.30	66
I	77	.32	77
J	87	.37	85
M	14	.12	12
N	27	.17	26
O	37	.19	35
P	51	.23	48
SOLID TEINTE PLATE	100	.40	100

PAPER - PAPIER

GRADE / CATÉGORIE: W.S. STANDARD

TYPE: UNCOATED - NON COUCHÉ

REFLECTIVITÉ / REFLECTIVITY: 87%

OPACITÉ / OPACITY: 87%

% CONTRASTE/CONTRAST: 13%

PLATE - PLAQUE

SUBT. - SOUST.

TYPE: NEGATIVE

PRESS - PRESSE

• MEIHLE

• UNIT(É) #: LOWER/INFÉRIEURE

The colour printed here was blended from, and should only be blended from PANTONE Basic Colours obtained from a PANTONE Licensed Printing Ink Manufacturer. Pantone, Inc. assumes no responsibility for the accuracy of the formulas or the colour reproduced.

La couleur ci-imprimée fut et devrait être mélangée seulement à partir des couleurs de base PANTONE obtenues d'un fabricant d'encre autorisé. La compagnie Pantone, Inc. n'assume aucune responsabilité quant à l'exactitude du mélange ou de la couleur obtenue.

RDD - DRD

COLOURS AND SCREENS

COULEURS ET TRAMES

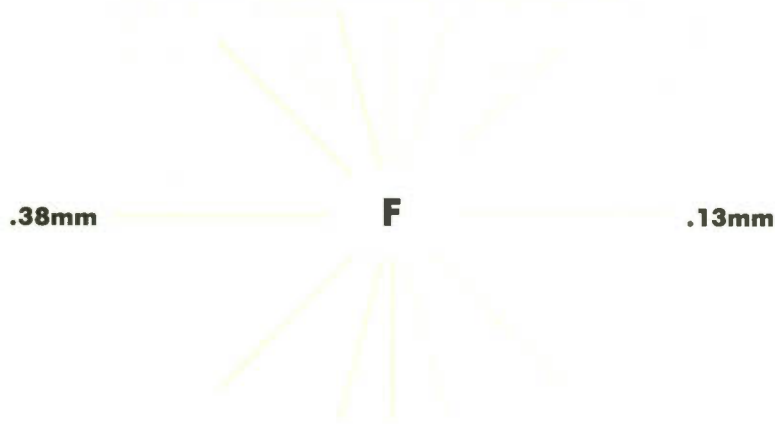

BIANGULAR SCREENS — TRAMES BIANGULÉES

M

12 pt. Times Ten Condensed	.08mm	
12 pt. Times Ten Condensed	.13mm	
12 pt. Times Ten Condensed	.18mm	
12 pt. Times Ten Condensed	.25mm	
12 pt. Times Ten Condensed	.38mm	

N

12 pt. Times Ten Condensed	.08mm	
12 pt. Times Ten Condensed	.13mm	
12 pt. Times Ten Condensed	.18mm	
12 pt. Times Ten Condensed	.25mm	
12 pt. Times Ten Condensed	.38mm	

O

12 pt. Times Ten Condensed	.08mm	
12 pt. Times Ten Condensed	.13mm	
12 pt. Times Ten Condensed	.18mm	
12 pt. Times Ten Condensed	.25mm	
12 pt. Times Ten Condensed	.38mm	

P

12 pt. Times Ten Condensed	.08mm	
12 pt. Times Ten Condensed	.13mm	
12 pt. Times Ten Condensed	.18mm	
12 pt. Times Ten Condensed	.25mm	
12 pt. Times Ten Condensed	.38mm	

SOLID — TEINTE PLATE

12 pt. Times Ten Condensed	.08mm	
12 pt. Times Ten Condensed	.13mm	
12 pt. Times Ten Condensed	.18mm	
12 pt. Times Ten Condensed	.25mm	
12 pt. Times Ten Condensed	.38mm	

A

B

C

D

E

F

G

H

I

J

S

TECHNICAL INFORMATION — DONNÉES TECHNIQUES

INK - ENCRE

PANTONE® * FORMUL (A)
(E)

COLOUR No. COULEUR : 5630-365

AIM SOLID DENSITY
DENSITÉ TEINTE PLATE VISÉE : 0.38 W/H 0.36 D/S

GRAYNESS - NETTETÉ : N/A

HUE ERROR - DÉVIATION DE : N/A
TEINTE

INK EFFICIENCY : N/A
EFFICACITÉ DE L'ENCRE

DENSITOMETRY / DENSITOMÉTRIE

• CHANNEL-SÉLECTION: YELLOW/JAUNE

• FILTER TYPE DE FILTRES: STATUS T

• FACTEUR n FACTOR: 2.7

* Pantone, Inc.'s check-standard trademark for colour reproduction and colour reproduction materials.

* La marque de Pantone, Inc. de contrôle uniforme pour la reproduction en couleur et les matériaux pour la reproduction en couleur.

CIE CHROMATICITY DIAGRAM(ME) DES CHROMATICITÉS CIE

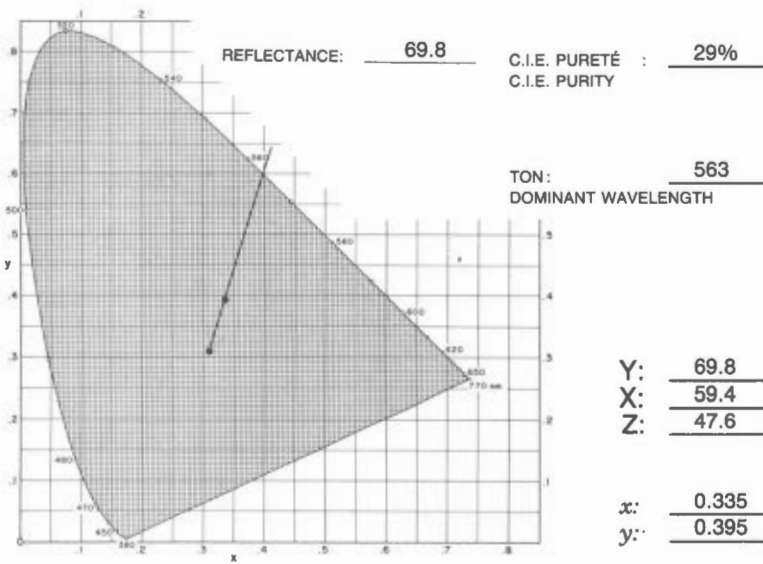

ID. PATCHES BLOCS IDEN.	% SCREEN TRAME	DENSITY DENSITÉ	% PRINT IMPRESSION
A	3	.08	1
B	6	.09	5
C	12	.11	12
D	22	.13	20
E	30	.15	29
F	40	.18	37
G	52	.22	52
H	66	.26	65
I	77	.29	77
J	87	.32	84
M	14	.10	9
N	27	.14	25
O	37	.17	34
P	51	.19	44
SOLID TEINTE PLATE	100	.36	100

PAPER - PAPIER

GRADE / CATÉGORIE: W.S. NEW BRITE

TYPE: UNCOATED - NON COUCHÉ

REFLECTIVITÉ / REFLECTIVITY: 87%

OPACITÉ / OPACITY: 85.5%

% CONTRASTE/CONTRAST: 19%

PLATE - PLAQUE

TYPE: SUBT. - SOUST.

TYPE: NEGATIVE

PRESS - PRESSE

• MEIHLE

• UNIT(É) #: LOWER/INFÉRIEURE

The colour printed here was blended from, and should only be blended from PANTONE Basic Colours obtained from a PANTONE Licensed Printing Ink Manufacturer. Pantone, Inc. assumes no responsibility for the accuracy of the formulas or the colour reproduced.

La couleur ci-imprimée fut et devrait être mélangée seulement à partir des couleurs de base PANTONE obtenues d'un fabricant d'encre autorisé. La compagnie Pantone, Inc. n'assume aucune responsabilité quant à l'exactitude du mélange ou de la couleur obtenue.

RDD - DRD

COLOURS AND SCREENS

COULEURS ET TRAMES



BIANGULAR SCREENS — TRAMES BIANGULÉES

M

- .08mm
- .13mm
- .18mm
- .25mm
- .38mm

N

- .08mm
- .13mm
- .18mm
- .25mm
- .38mm

O

- .08mm
- .13mm
- .18mm
- .25mm
- .38mm

P

- .08mm
- .13mm
- .18mm
- .25mm
- .38mm

SOLID — TEINTE PLATE

- 6 pt. Times Ten Bold/Condensed
- 8 pt. Times Ten Bold/Condensed
- 10 pt. Futura Roman/Romain
- 12 pt. CG Trade Condensed/Condensé

- .08mm
- .13mm
- .18mm
- .25mm
- .38mm

A
B
C
D
E
F
G
H
I
J
S

TECHNICAL INFORMATION — DONNÉES TECHNIQUES

INK - ENCRE

PANTONE® * FORMUL (A/E)

COLOUR No. COULEUR : 5640-373

- .1040 parts Pantone Process Yellow
- .0620 parts Pantone Green
- .8340 parts Pantone Extender

AIM SOLID DENSITY
DENSITÉ TEINTE PLATE VISÉE : 0.50 W/H 0.48 D/S

GRAYNESS - NETTETÉ : N/A

HUE ERROR - DÉVIATION DE : N/A
TEINTE

INK EFFICIENCY : N/A
EFFICACITÉ DE L'ENCRE

DENSITOMETRY / DENSITOMÉTRIE

- CHANNEL-SÉLECTION: YELLOW/JAUNE
- FILTER TYPE DE FILTRES: STATUS T
- FACTEUR n FACTOR: 2.7

* Pantone, Inc.'s check-standard trademark for colour reproduction and colour reproduction materials.
* La marque de Pantone, Inc. de contrôle uniforme pour la reproduction en couleur et les matériaux pour la reproduction en couleur.

CIE CHROMATICITY DIAGRAM(ME) DES CHROMATICITÉS CIE

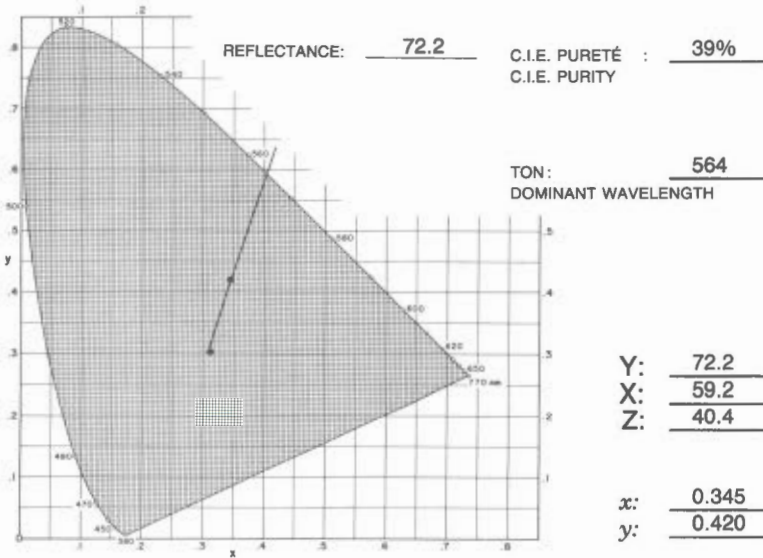

ID. PATCHES BLOCS IDEN.	% SCREEN FRAME	DENSITY DENSITÉ	% PRINT IMPRESSION
A	3	.10	4
B	6	.11	5
C	12	.13	12
D	22	.17	25
E	30	.20	36
F	40	.24	46
G	52	.29	60
H	66	.33	72
I	77	.38	82
J	87	.40	91
M	14	.14	15
N	27	.20	34
O	37	.23	44
P	51	.27	57
SOLID TEINTE PLATE	100	.45	100

PAPER - PAPIER

GRADE / CATÉGORIE: W.S. STANDARD

TYPE: UNCOATED - NON COUCHÉ

REFLECTIVITÉ / REFLECTIVITY: 87%

OPACITÉ / OPACITY: 87%

% CONTRASTE/CONTRAST: 21%

PLATE - PLAQUE

SUBT. - SOUST.

TYPE: NEGATIVE

PRESS - PRESSE

• MEIHLE

• UNIT(É) #: LOWER/INFÉRIEURE

The colour printed here was blended from, and should only be blended from PANTONE Basic Colours obtained from a PANTONE Licensed Printing Ink Manufacturer. Pantone, Inc. assumes no responsibility for the accuracy of the formulas or the colour reproduced.

La couleur ci-imprimée fut et devrait être mélangée seulement à partir des couleurs de base PANTONE obtenues d'un fabricant d'encre autorisé. La compagnie Pantone, Inc. n'assume aucune responsabilité quant à l'exactitude du mélange ou de la couleur obtenue.

RDD - DRD

COLOURS AND SCREENS

COULEURS ET TRAMES

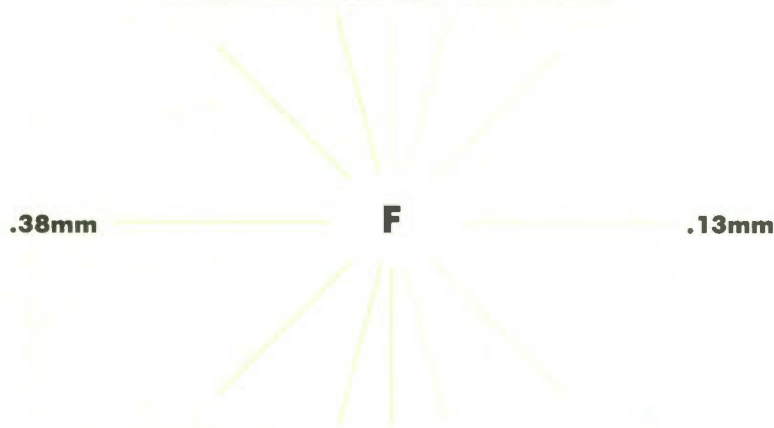

BIANGULAR SCREENS — TRAMES BIANGULÉES

M

12 pt. Century Text Italic/Italique	.08mm	
8 pt. Triumvirate Roman/Romain	.13mm	
10 pt. Futura Roman/Romain	.18mm	
12 pt. CG Trade Condensed/Condensé	.25mm	
	.38mm	

N

12 pt. Century Text Italic/Italique	.08mm	
8 pt. Triumvirate Roman/Romain	.13mm	
10 pt. Futura Roman/Romain	.18mm	
12 pt. CG Trade Condensed/Condensé	.25mm	
	.38mm	

O

12 pt. Century Text Italic/Italique	.08mm	
8 pt. Triumvirate Roman/Romain	.13mm	
10 pt. Futura Roman/Romain	.18mm	
12 pt. CG Trade Condensed/Condensé	.25mm	
	.38mm	

P

12 pt. Century Text Italic/Italique	.08mm	
8 pt. Triumvirate Roman/Romain	.13mm	
10 pt. Futura Roman/Romain	.18mm	
12 pt. CG Trade Condensed/Condensé	.25mm	
	.38mm	

SOLID — TEINTE PLATE

12 pt. Century Text Italic/Italique	.08mm	
8 pt. Triumvirate Roman/Romain	.13mm	
10 pt. Futura Roman/Romain	.18mm	
12 pt. CG Trade Condensed/Condensé	.25mm	
	.38mm	

A

B

C

D

E

F

G

H

I

J

S

TECHNICAL INFORMATION — DONNÉES TECHNIQUES

INK - ENCRE

PANTONE® * FORMUL (A_E)

COLOUR No. COULEUR : 5640-373

— .1040 parts Pantone Process Yellow

— .0620 parts Pantone Green

— .8340 parts Pantone Extender

—

AIM SOLID DENSITY
DENSITÉ TEINTE PLATE VISÉE : 0.50 W/H 0.47 D/S

GRAYNESS - NETTETÉ : N/A

HUE ERROR - DÉVIATION DE : N/A
TEINTE

INK EFFICIENCY : N/A
EFFICACITÉ DE L'ENCRE

DENSITOMETRY / DENSITOMÉTRIE

• CHANNEL-SÉLECTION: YELLOW/JAUNE

• FILTER TYPE DE FILTRES: STATUS T

• FACTEUR n FACTOR: 2.7

* Pantone, Inc.'s check-standard trademark for colour reproduction and colour reproduction materials.
* La marque de Pantone, Inc. de contrôle uniforme pour la reproduction en couleur et les matériaux pour la reproduction en couleur.

CIE CHROMATICITY DIAGRAM(ME) DES CHROMATICITÉS CIE

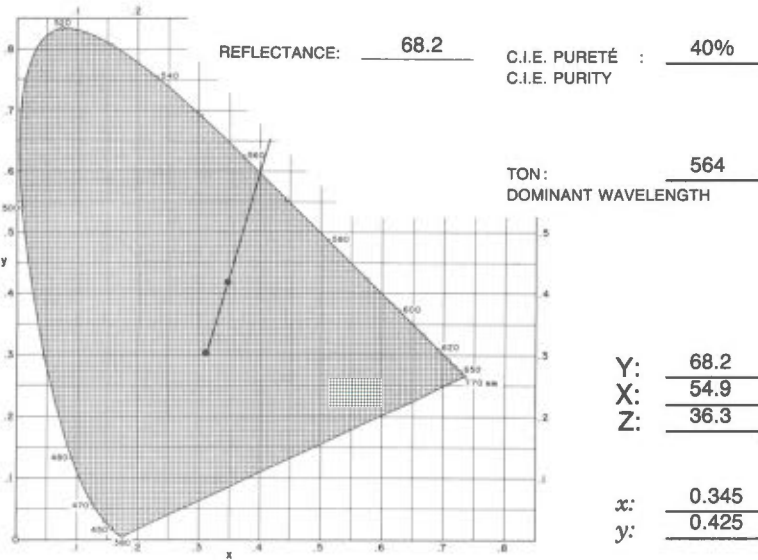

ID. PATCHES BLOCS IDEN.	% SCREEN TRAME	DENSITY DENSITÉ	% PRINT IMPRESSION
A	3	.09	3
B	6	.10	7
C	12	.12	15
D	22	.16	24
E	30	.20	35
F	40	.24	46
G	52	.29	60
H	66	.35	76
I	77	.38	82
J	87	.41	88
M	14	.14	18
N	27	.19	35
O	37	.23	46
P	51	.28	56
SOLID TEINTE PLATE	100	.46	100

PAPER - PAPIER

GRADE / CATÉGORIE: W.S. NEW BRITE

TYPE: UNCOATED - NON COUCHÉ

REFLECTIVITÉ / REFLECTIVITY: 85%

OPACITÉ / OPACITY: 85.5%

% CONTRASTE/CONTRAST: 19%

PLATE - PLAQUE

SUBT. - SOUST.

TYPE: NEGATIVE

PRESS - PRESSE

• MEIHLE

• UNIT(É) #: LOWER/INFÉRIEURE

The colour printed here was blended from, and should only be blended from PANTONE Basic Colours obtained from a PANTONE Licensed Printing Ink Manufacturer.
Pantone, Inc. assumes no responsibility for the accuracy of the formulas or the colour reproduced.

La couleur ci-imprimée fut et devrait être mélangée seulement à partir des couleurs de base PANTONE obtenues d'un fabricant d'encre autorisé.
La compagnie Pantone, Inc. n'assume aucune responsabilité quant à l'exactitude du mélange ou de la couleur obtenue.

RDD - DRD

COLOURS AND SCREENS

COULEURS ET TRAMES



BIANGULAR SCREENS — TRAMES BIANGULÉES

M

8 pt. Century Text / 10 pt. Century Text / 12 pt. Century Text / 12 pt. CG Trade Condensed	.08mm .13mm .18mm .25mm .38mm	
---	---	--

N

8 pt. Century Text / 10 pt. Century Text / 12 pt. Century Text / 12 pt. CG Trade Condensed	.08mm .13mm .18mm .25mm .38mm	
---	---	--

O

8 pt. Century Text / 10 pt. Century Text / 12 pt. Century Text / 12 pt. CG Trade Condensed	.08mm .13mm .18mm .25mm .38mm	
---	---	--

P

8 pt. Century Text / 10 pt. Century Text / 12 pt. Century Text / 12 pt. CG Trade Condensed	.08mm .13mm .18mm .25mm .38mm	
---	---	--

SOLID — TEINTE PLATE

8 pt. Century Text / 10 pt. Century Text / 12 pt. Century Text / 12 pt. CG Trade Condensed	.08mm .13mm .18mm .25mm .38mm	
---	---	--

A

B

C

D

E

F

G

H

I

J

S

TECHNICAL INFORMATION — DONNÉES TECHNIQUES

INK - ENCRE

PANTONE® * FORMUL (A/E)

COLOUR No. COULEUR : 5680-146

- .1180 parts Pantone Process Yellow
- .0360 parts Pantone Process Blue
- .7800 parts Pantone Extender
- .0660 parts Pantone Opaque White

AIM SOLID DENSITY
DENSITÉ TEINTE PLATE VISÉE : 0.37 W/H 0.34 D/S

GRAYNESS - NETTETÉ : N/A

HUE ERROR - DÉVIATION DE : N/A
TEINTE

INK EFFICIENCY : N/A
EFFICACITÉ DE L'ENCRE

DENSITOMETRY / DENSITOMÉTRIE

- CHANNEL-SÉLECTION: YELLOW/JAUNE
- FILTER TYPE DE FILTRES: STATUS T
- FACTEUR n FACTOR: 2.7

* Pantone, Inc.'s check-standard trademark for colour reproduction and colour reproduction materials.

* La marque de Pantone, Inc. de contrôle uniforme pour la reproduction en couleur et les matériaux pour la reproduction en couleur.

CIE CHROMATICITY DIAGRAM(ME) DES CHROMATICITÉS CIE

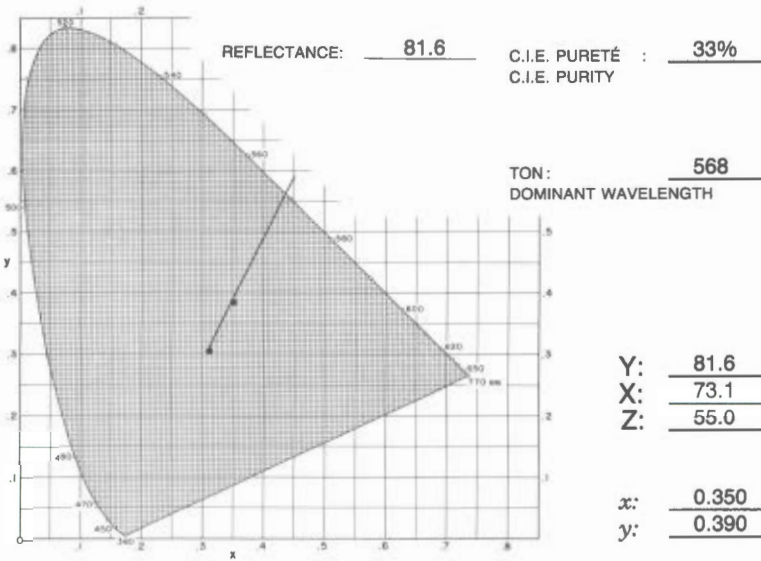

ID. PATCHES BLOCS IDEN.	% SCREEN FRAME	DENSITY DENSITÉ	% PRINT IMPRESSION
A	3	.09	5
B	6	.10	7
C	12	.12	15
D	22	.14	25
E	30	.16	35
F	40	.19	46
G	52	.22	57
H	66	.25	70
I	77	.26	76
J	87	.29	86
M	14	.13	17
N	27	.17	34
O	37	.19	44
P	51	.22	58
SOLID TEINTE PLATE	100	.32	100

PAPER - PAPIER

GRADE / CATÉGORIE: W.S. STANDARD

TYPE: UNCOATED - NON COUCHÉ

REFLECTIVITÉ / REFLECTIVITY: 81%

OPACITÉ / OPACITY: 87%

% CONTRASTE/CONTRAST: 19%

PLATE - PLAQUE

SUBT. - SOUST.

TYPE: NEGATIVE

PRESS - PRESSE

• MEIHLE

• UNIT(É) #: LOWER/INFÉRIEURE

The colour printed here was blended from, and should only be blended from PANTONE Basic Colours obtained from a PANTONE Licensed Printing Ink Manufacturer. Pantone, Inc. assumes no responsibility for the accuracy of the formulas or the colour reproduced.

La couleur ci-imprimée fut et devrait être mélangée seulement à partir des couleurs de base PANTONE obtenues d'un fabricant d'encre autorisé. La compagnie Pantone, Inc. n'assume aucune responsabilité quant à l'exactitude du mélange ou de la couleur obtenue.

RDD - DRD

COLOURS AND SCREENS

COULEURS ET TRAMES



BIANGULAR SCREENS — TRAMES BIANGULÉES

M

4 pt. Century Type/Condensed	.08mm	
6 pt. Century Type/Condensed	.13mm	
8 pt. Century Type/Condensed	.18mm	
10 pt. Century Type/Condensed	.25mm	
12 pt. Century Type/Condensed	.38mm	

N

4 pt. Century Type/Condensed	.08mm	
6 pt. Century Type/Condensed	.13mm	
8 pt. Century Type/Condensed	.18mm	
10 pt. Century Type/Condensed	.25mm	
12 pt. Century Type/Condensed	.38mm	

O

4 pt. Century Type/Condensed	.08mm	
6 pt. Century Type/Condensed	.13mm	
8 pt. Century Type/Condensed	.18mm	
10 pt. Century Type/Condensed	.25mm	
12 pt. Century Type/Condensed	.38mm	

P

4 pt. Century Type/Condensed	.08mm	
6 pt. Century Type/Condensed	.13mm	
8 pt. Century Type/Condensed	.18mm	
10 pt. Century Type/Condensed	.25mm	
12 pt. Century Type/Condensed	.38mm	

SOLID — TEINTE PLATE

4 pt. Century Type/Condensed	.08mm	
6 pt. Century Type/Condensed	.13mm	
8 pt. Century Type/Condensed	.18mm	
10 pt. Century Type/Condensed	.25mm	
12 pt. Century Type/Condensed	.38mm	

A

B

C

D

E

F

G

H

I

J

S

TECHNICAL INFORMATION — DONNÉES TECHNIQUES

INK - ENCRE

PANTONE® * FORMUL (A)

COLOUR No. COULEUR : 5680-146

- .1180 parts Pantone Process Yellow
- .0360 parts Pantone Process Blue
- .7800 parts Pantone Extender
- .0660 parts Pantone Opaque White

AIM SOLID DENSITY
DENSITÉ TEINTE PLATE VISÉE : 0.38 W/H 0.35 D/S

GRAYNESS - NETTETÉ : N/A

HUE ERROR - DÉVIATION DE : N/A
TEINTE

INK EFFICIENCY : N/A
EFFICACITÉ DE L'ENCRE

DENSITOMETRY / DENSITOMÉTRIE

- CHANNEL-SÉLECTION: YELLOW/JAUNE
- FILTER TYPE DE FILTRES: STATUS T
- FACTEUR n FACTOR: 2.7

* Pantone, Inc.'s check-standard trademark for colour reproduction and colour reproduction materials.
* La marque de Pantone, Inc. de contrôle uniforme pour la reproduction en couleur et les matériaux pour la reproduction en couleur.

CIE CHROMATICITY DIAGRAM(ME) DES CHROMATICITÉS CIE

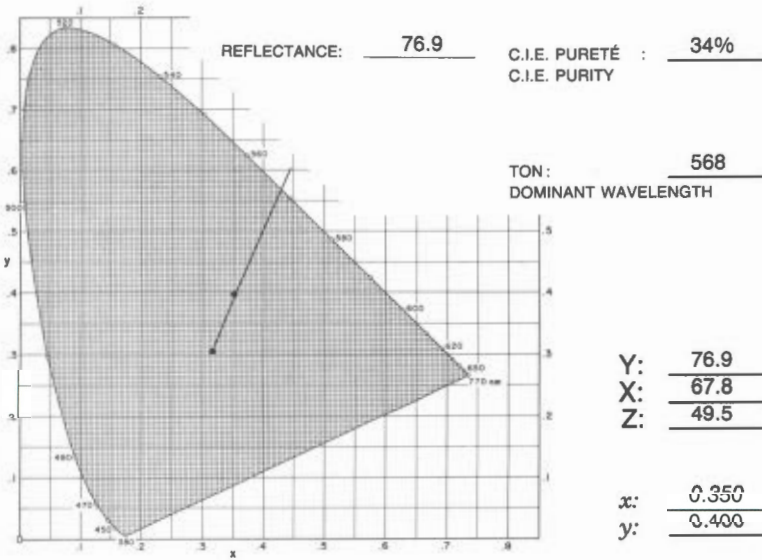

PAPER - PAPIER

GRADE / CATÉGORIE: W.S. NEW BRITE

TYPE: UNCOATED - NON COUCHÉ

REFLECTIVITÉ / REFLECTIVITY: 85%

OPACITÉ / OPACITY: 85.5%

% CONTRASTE/CONTRAST: 15%

PLATE - PLAQUE

SUBT. - SOUST. :

TYPE: NEGATIVE

PRESS - PRESSE

• MEHLE

• UNIT(É) #: LOWER/INFÉRIEURE

ID. PATCHES BLOCS IDEN.	% SCREEN TRAME	DENSITY DENSITÉ	% PRINT IMPRESSION
A	3	.09	6
B	6	.09	8
C	12	.11	17
D	22	.14	26
E	30	.16	38
F	40	.20	50
G	52	.23	60
H	66	.26	76
I	77	.29	82
J	87	.31	89
M	14	.12	19
N	27	.17	37
O	37	.19	50
P	51	.22	56
SOLID TEINTE PLATE	100	.34	100

The colour printed here was blended from, and should only be blended from PANTONE Basic Colours obtained from a PANTONE Licensed Printing Ink Manufacturer.
Pantone, Inc. assumes no responsibility for the accuracy of the formulas or the colour reproduced.

La couleur ci-imprimée fut et devrait être mélangée seulement à partir des couleurs de base PANTONE obtenues d'un fabricant d'encre autorisé.
La compagnie Pantone, Inc. n'assume aucune responsabilité quant à l'exactitude du mélange ou de la couleur obtenue.

RDD - DRD
COLOURS AND SCREENS
COULEURS ET TRAMES

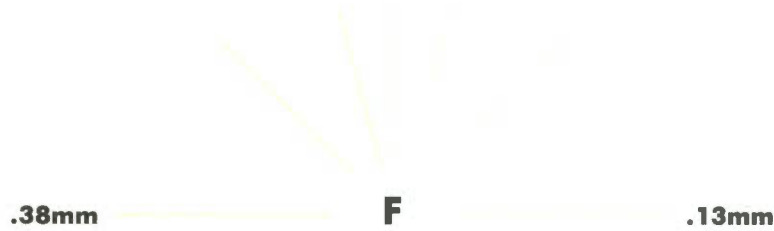

BIANGULAR SCREENS — TRAMES BIANGULÉES

M

- .08mm
- .13mm
- .18mm
- .25mm
- .38mm

N

- .08mm
- .13mm
- .18mm
- .25mm
- .38mm

O

- .08mm
- .13mm
- .18mm
- .25mm
- .38mm

P

- .08mm
- .13mm
- .18mm
- .25mm
- .38mm

SOLID — TEINTE PLATE

- 4 pt. Century Text Bold/Italique
- 8 pt. Titulum Roman/Romanne
- 10 pt. Futura Roman/Romain
- 12 pt. CG Trade Condensed/Condensé

- .08mm
- .13mm
- .18mm
- .25mm
- .38mm

A

B

C

D

E

F

G

H

I

J

S

TECHNICAL INFORMATION — DONNÉES TECHNIQUES

INK - ENCRE

PANTONE® * FORMUL (A/E)

COLOUR No. COULEUR : 5711-143

- .4890 parts Pantone 012 Yellow
- .0250 parts Pantone Green
- .0230 parts Pantone Mixing Black
- .4650 parts Pantone Extender

AIM SOLID DENSITY
DENSITÉ TEINTE PLATE VISÉE : 0.59 W/H 0.54 D/S

GRAYNESS - NETTETÉ : N/A

HUE ERROR - DÉVIATION DE : N/A
TEINTE

INK EFFICIENCY : N/A
EFFICACITÉ DE L'ENCRE

DENSITOMETRY / DENSITOMÉTRIE

- CHANNEL-SÉLECTION: YELLOW/JAUNE
- FILTER TYPE DE FILTRES: STATUS T
- FACTEUR n FACTOR: 2.7

* Pantone, Inc.'s check-standard trademark for colour reproduction and colour reproduction materials.
* La marque de Pantone, Inc. de contrôle uniforme pour la reproduction en couleur et les matériaux pour la reproduction en couleur.

CIE CHROMATICITY DIAGRAM(ME) DES CHROMATICITÉS CIE

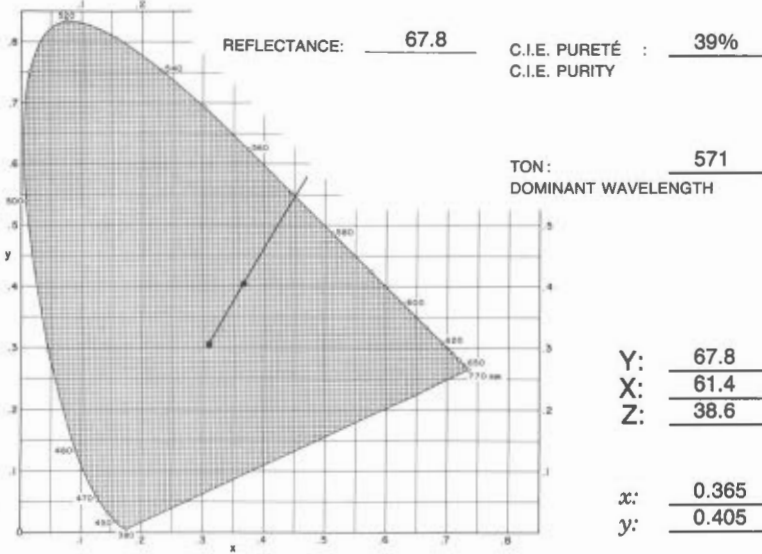

ID. PATCHES BLOCS IDEN.	% SCREEN TRAME	DENSITY DENSITÉ	% PRINT IMPRESSION
A	3	.11	4
B	6	.11	8
C	12	.15	18
D	22	.19	29
E	30	.22	40
F	40	.27	52
G	52	.32	63
H	66	.37	77
I	77	.41	86
J	87	.43	88
M	14	.15	19
N	27	.22	41
O	37	.26	50
P	51	.30	61
SOLID TEINTE PLATE	100	.45	100

PAPER - PAPIER

GRADE / CATÉGORIE: W.S. STANDARD

TYPE: UNCOATED - NON COUCHÉ

REFLECTIVITÉ / REFLECTIVITY: 87%

OPACITÉ / OPACITY: 87%

% CONTRASTE/CONTRAST: 24%

PLATE - PLAQUE

SUBT. - SOUST.

TYPE: NEGATIVE

PRESS - PRESSE

• MEIHLE

• UNIT(É) #: LOWER/INFÉRIEURE

The colour printed here was blended from, and should only be blended from PANTONE Basic Colours obtained from a PANTONE Licensed Printing Ink Manufacturer.
Pantone, Inc. assumes no responsibility for the accuracy of the formulas or the colour reproduced.

La couleur ci-imprimée fut et devrait être mélangée seulement à partir des couleurs de base PANTONE obtenues d'un fabricant d'encre autorisé.
La compagnie Pantone, Inc. n'assume aucune responsabilité quant à l'exactitude du mélange ou de la couleur obtenue.

RDD - DRD

COLOURS AND SCREENS

COULEURS ET TRAMES

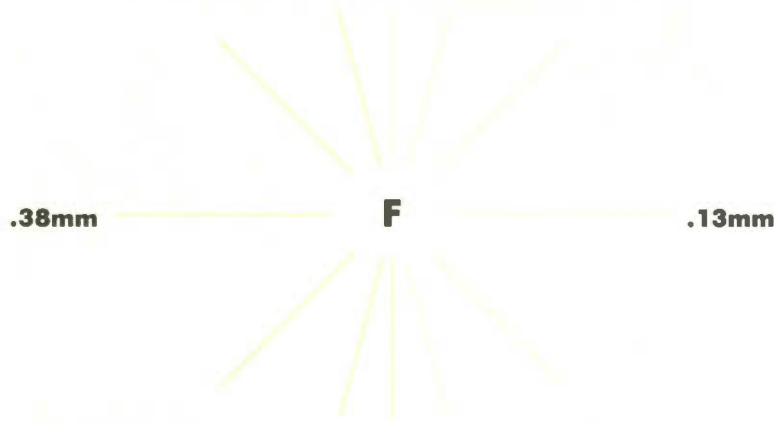

BIANGULAR SCREENS — TRAMES BIANGULÉES

M

8 pt. Century Text/Italique	.08mm	
8 pt. Triumvirate Roman/Romain	.13mm	
10 pt. Futura Roman/Romain	.18mm	
12 pt. CG Trade Condensed/Condensé	.25mm	
	.38mm	

N

8 pt. Century Text/Italique	.08mm	
8 pt. Futura Roman/Romain	.13mm	
10 pt. CG Trade Condensed/Condensé	.18mm	
12 pt. Cent. Text It/Italique	.25mm	
	.38mm	

O

8 pt. Century Text/Italique	.08mm	
8 pt. CG Trade Condensed/Condensé	.13mm	
10 pt. Century Text It/Italique	.18mm	
12 pt. Trium. Rom/Romain	.25mm	
	.38mm	

P

8 pt. CG Trade Condensed/Condensé	.08mm	
8 pt. Century Text It/Italique	.13mm	
10 pt. Triumvirate Roman/Romain	.18mm	
12 pt. Futura Roman/Romain	.25mm	
	.38mm	

SOLID — TEINTE PLATE

8 pt. Century Text It/Italique	.08mm	
8 pt. Triumvirate Roman/Romain	.13mm	
10 pt. Futura Roman/Romain	.18mm	
12 pt. CG Trade Condensed/Condensé	.25mm	
	.38mm	

A

B

C

D

E

F

G

H

I

J

S

TECHNICAL INFORMATION — DONNÉES TECHNIQUES

INK - ENCRE

PANTONE® * FORMUL (A)_E

COLOUR No. COULEUR : 5711-143

- .4890 parts Pantone 012 Yellow
- .0250 parts Pantone Green
- .0230 parts Pantone Mixing Black
- .4650 parts Pantone Extender

AIM SOLID DENSITY
DENSITÉ TEINTE PLATE VISÉE: 0.59 W/H 0.54 D/S

GRAYNESS - NETTETÉ : N/A

HUE ERROR - DÉVIATION DE : N/A
TEINTE

INK EFFICIENCY
EFFICACITÉ DE L'ENCRE : N/A

DENSITOMETRY / DENSITOMÉTRIE

- CHANNEL-SÉLECTION: YELLOW/JAUNE
- FILTER TYPE DE FILTRES: STATUS T
- FACTEUR n FACTOR: 2.7

* Pantone, Inc.'s check-standard trademark for colour reproduction and colour reproduction materials.
* La marque de Pantone, Inc. de contrôle uniforme pour la reproduction en couleur et les matériaux pour la reproduction en couleur.

CIE CHROMATICITY DIAGRAM(ME) DES CHROMATICITÉS CIE

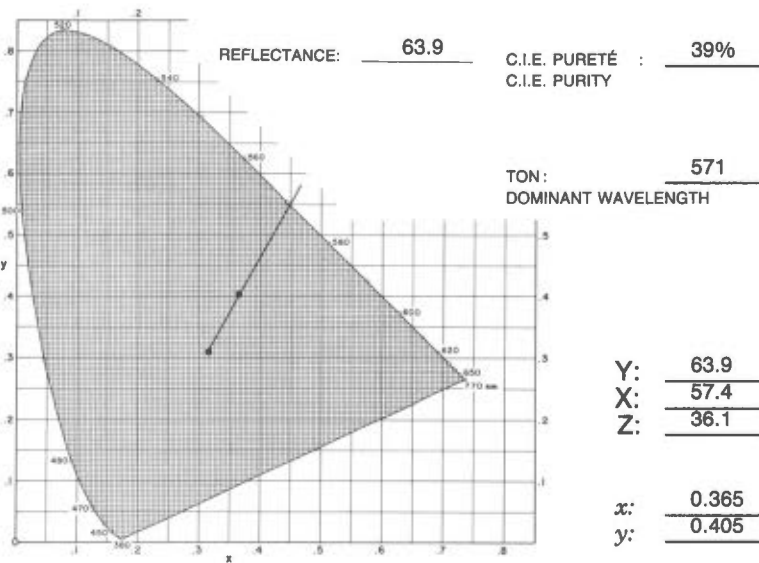

PAPER - PAPIER

GRADE / CATÉGORIE: W.S. NEW BRITE

TYPE: UNCOATED - NON COUCHÉ

REFLECTIVITÉ / REFLECTIVITY: 85%

OPACITÉ / OPACITY: 85.5%

% CONTRASTE/CONTRAST: 24%

PLATE - PLAQUE

SUBT. - SOUST.

TYPE: NEGATIVE

PRESS - PRESSE

• MEIHLE

• UNIT(É) #: LOWER/INFÉRIEURE

ID. PATCHES BLOCS IDEN.	% SCREEN TRAME	DENSITY DENSITÉ	% PRINT IMPRESSION
A	3	.09	4
B	6	.10	7
C	12	.13	16
D	22	.18	29
E	30	.22	38
F	40	.27	50
G	52	.31	61
H	66	.37	73
I	77	.41	83
J	87	.44	90
M	14	.15	20
N	27	.22	38
O	37	.26	48
P	51	.29	58
SOLID TEINTE PLATE	100	.47	100

The colour printed here was blended from, and should only be blended from PANTONE Basic Colours obtained from a PANTONE Licensed Printing Ink Manufacturer.
Pantone, Inc. assumes no responsibility for the accuracy of the formulas or the colour reproduced.

La couleur ci-imprimée fut et devrait être mélangée seulement à partir des couleurs de base PANTONE obtenues d'un fabricant d'encre autorisé.
La compagnie Pantone, Inc. n'assume aucune responsabilité quant à l'exactitude du mélange ou de la couleur obtenue.

RDD - DRD

COLOURS AND SCREENS

COULEURS ET TRAMES

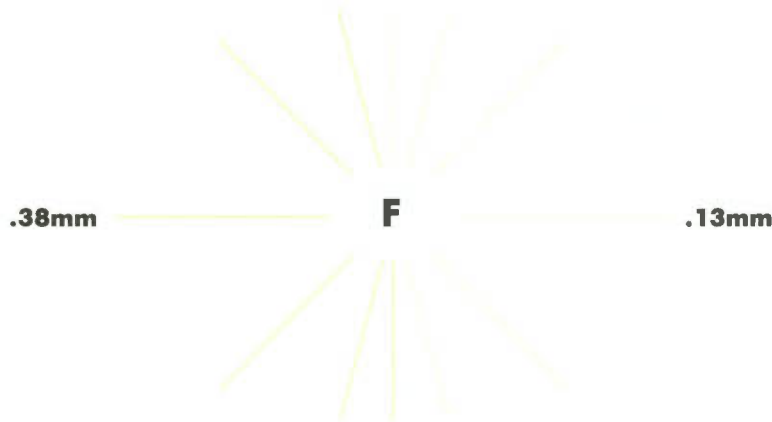

BIANGULAR SCREENS — TRAMES BIANGULÉES

M

4 pt. Century Text Italic/Italique	.08mm	
8 pt. Futura Roman/Romain	.13mm	
10 pt. Futura Roman/Romain	.18mm	
12 pt. CG Trade Condensed/Condensé	.25mm	
12 pt. CG Trade Condensed/Condensé	.38mm	

N

4 pt. Century Text Italic/Italique	.08mm	
8 pt. Futura Roman/Romain	.13mm	
10 pt. CG Trade Condensed/Condensé	.18mm	
12 pt. Century Text Italic/Italique	.25mm	
12 pt. Century Text Italic/Italique	.38mm	

O

4 pt. Century Text Italic/Italique	.08mm	
8 pt. CG Trade Condensed/Condensé	.13mm	
10 pt. Century Text Italic/Italique	.18mm	
12 pt. Century Text Italic/Italique	.25mm	
12 pt. Trium. Rom./Romain	.38mm	

P

4 pt. CG Trade Condensed/Condensé	.08mm	
8 pt. Century Text Italic/Italique	.13mm	
10 pt. Triumvirate Roman/Romain	.18mm	
12 pt. Futura Roman/Romain	.25mm	
12 pt. Futura Roman/Romain	.38mm	

SOLID — TEINTE PLATE

4 pt. Century Text Italic/Italique	.08mm	
8 pt. Triumvirate Roman/Romain	.13mm	
10 pt. Futura Roman/Romain	.18mm	
12 pt. CG Trade Condensed/Condensé	.25mm	
12 pt. CG Trade Condensed/Condensé	.38mm	

A

B

C

D

E

F

G

H

I

J

S

TECHNICAL INFORMATION — DONNÉES TECHNIQUES

INK - ENCRE

PANTONE® * FORMUL (A)
(E)

COLOUR No. COULEUR : 5721-5727

- .4040 parts Pantone Extender
- .0370 parts Pantone Process Yellow
- .0040 parts Pantone Mixing Black
- .0010 parts Pantone Warm Red
- .5540 parts Pantone Opaque White

AIM SOLID DENSITY
DENSITÉ TEINTE PLATE VISÉE : 0.33 W/H 0.32 D/S

GRAYNESS - NETTETÉ : N/A

HUE ERROR - DÉVIATION DE : N/A
TEINTE

INK EFFICIENCY : N/A
EFFICACITÉ DE L'ENCRE

DENSITOMETRY / DENSITOMÉTRIE

- CHANNEL-SÉLECTION: YELLOW/JAUNE
- FILTER TYPE DE FILTRES: STATUS T
- FACTEUR n FACTOR: 2.7

* Pantone, Inc.'s check-standard trademark for colour reproduction and colour reproduction materials.
* La marque de Pantone, Inc. de contrôle uniforme pour la reproduction en couleur et les matériaux pour la reproduction en couleur.

CIE CHROMATICITY DIAGRAM(ME) DES CHROMATICITÉS CIE

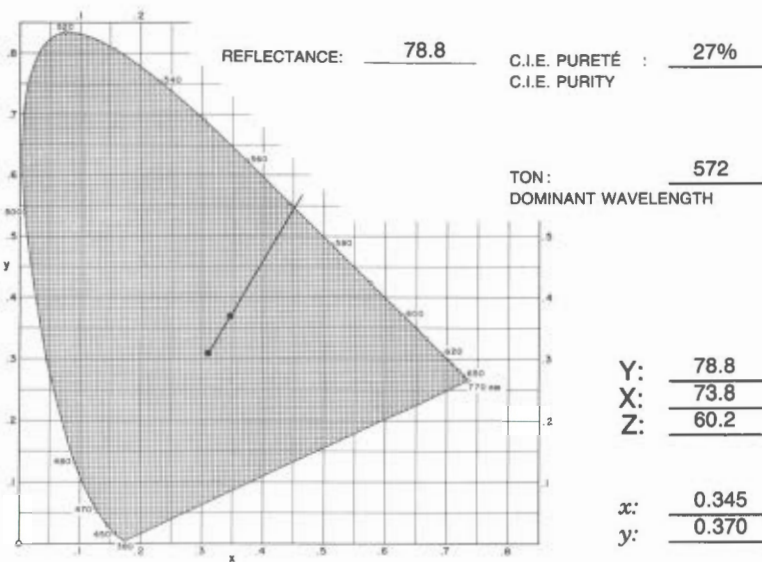

ID. PATCHES BLOCS IDEN.	% SCREEN FRAME	DENSITY DENSITÉ	% PRINT IMPRESSION
A	3	.10	1
B	6	.11	3
C	12	.12	9
D	22	.14	20
E	30	.16	33
F	40	.19	45
G	52	.22	61
H	66	.25	77
I	77	.27	86
J	87	.28	89
M	14	.13	15
N	27	.16	36
O	37	.18	44
P	51	.22	53
SOLID TEINTE PLATE	100	.29	100

PAPER - PAPIER

GRADE / CATÉGORIE: W.S. STANDARD

TYPE: UNCOATED - NON COUCHÉ

REFLECTIVITÉ / REFLECTIVITY: 81%

OPACITÉ / OPACITY: 87%

% CONTRASTE/CONTRAST: 10%

PLATE - PLAQUE

SUBT. - SOUST.

TYPE: NEGATIVE

PRESS - PRESSE

• MEIHLE

• UNIT(É) #: LOWER/INFÉRIEURE

The colour printed here was blended from, and should only be blended from PANTONE Basic Colours obtained from a PANTONE Licensed Printing Ink Manufacturer.
Pantone, Inc. assumes no responsibility for the accuracy of the formulas or the colour reproduced.

La couleur ci-imprimée fut et devrait être mélangée seulement à partir des couleurs de base PANTONE obtenues d'un fabricant d'encre autorisé.
La compagnie Pantone, Inc. n'assume aucune responsabilité quant à l'exactitude du mélange ou de la couleur obtenue.

RDD - DRD

COLOURS AND SCREENS

COULEURS ET TRAMES

.38mm **F** .13mm

BIANGULAR SCREENS — TRAMES BIANGULÉES

M

.08mm
.13mm
.18mm
.25mm
.38mm

N

.08mm
.13mm
.18mm
.25mm
.38mm

O

.08mm
.13mm
.18mm
.25mm
.38mm

P

.08mm
.13mm
.18mm
.25mm
.38mm

SOLID — TEINTE PLATE

4 pt. Transvaal Roman/Roman
10 pt. Futura Roman/Romain
12 pt. CG Trade Condensed/Condensé

.08mm
.13mm
.18mm
.25mm
.38mm

A
B
C
D
E
F
G
H
I
J
S

TECHNICAL INFORMATION — DONNÉES TECHNIQUES

INK - ENCRE

PANTONE® * FORMUL(A)
(E)

COLOUR No. COULEUR : 5721-5727

- .4040 parts Pantone Extender
- .0370 parts Pantone Process Yellow
- .0040 parts Pantone Mixing Black
- .0010 parts Pantone Warm Red
- .5540 parts Pantone Opaque White

AIM SOLID DENSITY
DENSITÉ TEINTE PLATE VISÉE : 0.32 W/H 0.29 D/S

GRAYNESS - NETTETÉ : N/A

HUE ERROR - DÉVIATION DE : N/A
TEINTE

INK EFFICIENCY : N/A
EFFICACITÉ DE L'ENCRE

DENSITOMETRY / DENSITOMÉTRIE

- CHANNEL-SÉLECTION: YELLOW/JAUNE
- FILTER TYPE DE FILTRES: STATUS T
- FACTEUR n FACTOR: 2.7

* Pantone, Inc.'s check-standard trademark for colour reproduction and colour reproduction materials.
* La marque de Pantone, Inc. de contrôle uniforme pour la reproduction en couleur et les matériaux pour la reproduction en couleur.

CIE CHROMATICITY DIAGRAM(ME) DES CHROMATICITÉS CIE

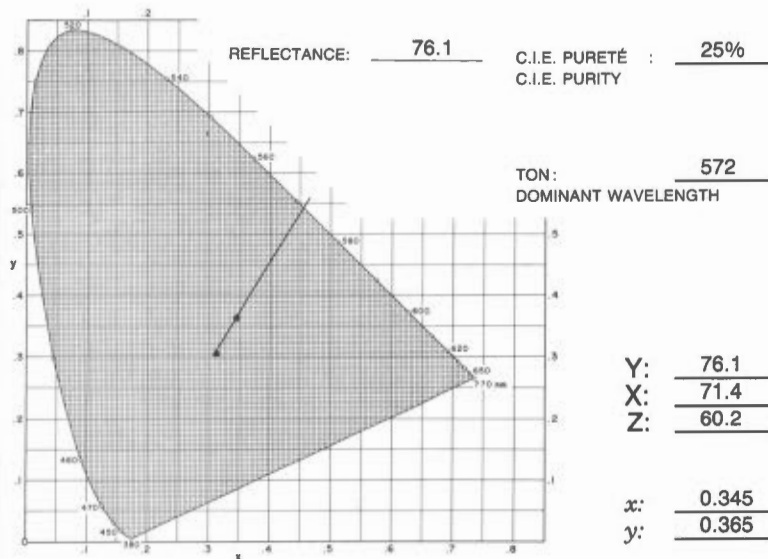

ID. PATCHES BLOCS IDEN.	% SCREEN TRAME	DENSITY DENSITÉ	% PRINT IMPRESSION
A	3	.09	3
B	6	.10	4
C	12	.11	13
D	22	.13	23
E	30	.15	32
F	40	.18	46
G	52	.21	64
H	66	.24	80
I	77	.25	91
J	87	.28	96
M	14	.12	18
N	27	.15	29
O	37	.17	43
P	51	.19	58
SOLID TEINTE PLATE	100	.29	100

PAPER - PAPIER

GRADE / CATÉGORIE: W.S. NEW BRITE

TYPE: UNCOATED - NON COUCHÉ

REFLECTIVITÉ / REFLECTIVITY: 83%

OPACITÉ / OPACITY: 85.5%

% CONTRASTE/CONTRAST: 18%

PLATE - PLAQUE

SUBT. - SOUST.

TYPE: NEGATIVE

PRESS - PRESSE

• MEIHLE

• UNIT(É) #: LOWER/INFÉRIEURE

The colour printed here was blended from, and should only be blended from PANTONE Basic Colours obtained from a PANTONE Licensed Printing Ink Manufacturer.
Pantone, Inc. assumes no responsibility for the accuracy of the formulas or the colour reproduced.

La couleur ci-imprimée fut et devrait être mélangée seulement à partir des couleurs de base PANTONE obtenues d'un manufacturier d'encre autorisé.
La compagnie Pantone, Inc. n'assume aucune responsabilité quant à l'exactitude du mélange ou de la couleur obtenue.

0 1 2 3
8 9 8 8
m m m m

COLOUR NO. 5727
No. DE COULEUR

RDD - DRD

COLOURS AND SCREENS

COULEURS ET TRAMES

.38mm

F

.13mm

BIANGULAR SCREENS — TRAMES BIANGULÉES

M

.08mm
.13mm
.18mm
.25mm
.38mm

N

.08mm
.13mm
.18mm
.25mm
.38mm

O

.08mm
.13mm
.18mm
.25mm
.38mm

P

.08mm
.13mm
.18mm
.25mm
.38mm

SOLID — TEINTE PLATE

.08mm
.13mm
.18mm
.25mm
.38mm

A

B

C

D

E

F

G

H

I

J

S

0 0 0 0
0 0 0 0
8 6 7 0

TECHNICAL INFORMATION — DONNÉES TECHNIQUES

INK - ENCRE

PANTONE® * FORMUL (A/E)

- .1420 parts Pantone Process Yellow
- .0070 parts Pantone Mixing Black
- .8510 parts Pantone Extender

COLOUR No. COULEUR : 5722-2404

AIM SOLID DENSITY
DENSITÉ TEINTE PLATE VISÉE : 0.39 W/H 0.37 D/S

GRAYNESS - NETTETÉ : N/A

HUE ERROR - DÉVIATION DE : N/A
TEINTE

INK EFFICIENCY : N/A
EFFICACITÉ DE L'ENCRE

DENSITOMETRY / DENSITOMÉTRIE

- CHANNEL-SÉLECTION: YELLOW/JAUNE
- FILTER TYPE DE FILTRES: STATUS T
- FACTEUR n FACTOR: 2.7

* Pantone, Inc.'s check-standard trademark for colour reproduction and colour reproduction materials.
* La marque de Pantone, Inc. de contrôle uniforme pour la reproduction en couleur et les matériaux pour la reproduction en couleur.

CIE CHROMATICITY DIAGRAM(ME) DES CHROMATICITÉS CIE

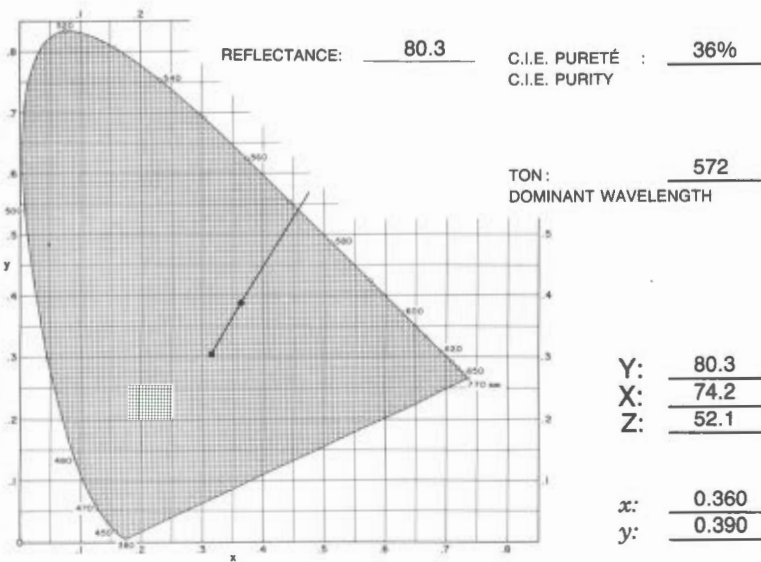

PAPER - PAPIER

GRADE / CATÉGORIE: W.S. STANDARD

TYPE: UNCOATED - NON COUCHÉ

REFLECTIVITÉ / REFLECTIVITY: 79%

OPACITÉ / OPACITY: 87%

% CONTRASTE/CONTRAST: 15%

PLATE - PLAQUE

SUBT. - SOUST.

TYPE: NEGATIVE

PRESS - PRESSE

• MEIHLE

• UNIT(É) #: LOWER/INFÉRIEURE

ID. PATCHES BLOCS IDEN.	% SCREEN TRAME	DENSITY DENSITÉ	% PRINT IMPRESSION
A	3	.11	2
B	6	.11	6
C	12	.13	14
D	22	.16	26
E	30	.18	35
F	40	.21	45
G	52	.24	59
H	66	.29	72
I	77	.30	83
J	87	.32	87
M	14	.15	20
N	27	.19	37
O	37	.21	46
P	51	.24	57
SOLID TEINTE PLATE	100	.34	100

The colour printed here was blended from, and should only be blended from PANTONE Basic Colours obtained from a PANTONE Licensed Printing Ink Manufacturer.
Pantone, Inc. assumes no responsibility for the accuracy of the formulas or the colour reproduced.

La couleur ci-imprimée fut et devrait être mélangée seulement à partir des couleurs de base PANTONE obtenues d'un fabricant d'encre autorisé.
La compagnie Pantone, Inc. n'assume aucune responsabilité quant à l'exactitude du mélange ou de la couleur obtenue.

RDD - DRD

COLOURS AND SCREENS

COULEURS ET TRAMES

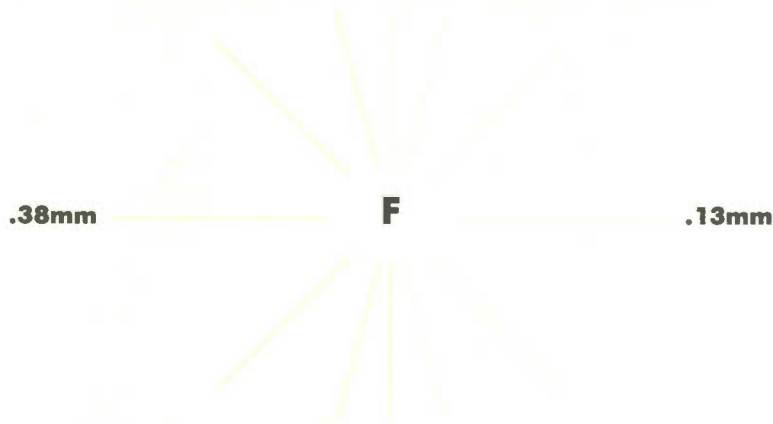

BIANGULAR SCREENS — TRAMES BIANGULÉES

M

1 pt. Century Text/Italique	.08mm	
4 pt. Century Text/Italique	.13mm	
8 pt. Century Text/Italique	.18mm	
12 pt. Century Text/Italique	.25mm	
18 pt. Century Text/Italique	.38mm	

N

1 pt. Century Text/Italique	.08mm	
4 pt. Century Text/Italique	.13mm	
8 pt. Century Text/Italique	.18mm	
12 pt. Century Text/Italique	.25mm	
18 pt. Century Text/Italique	.38mm	

O

1 pt. Century Text/Italique	.08mm	
4 pt. Century Text/Italique	.13mm	
8 pt. Century Text/Italique	.18mm	
12 pt. Century Text/Italique	.25mm	
18 pt. Century Text/Italique	.38mm	

P

1 pt. Century Text/Italique	.08mm	
4 pt. Century Text/Italique	.13mm	
8 pt. Century Text/Italique	.18mm	
12 pt. Century Text/Italique	.25mm	
18 pt. Century Text/Italique	.38mm	

SOLID — TEINTE PLATE

1 pt. Century Text/Italique	.08mm	
4 pt. Century Text/Italique	.13mm	
8 pt. Century Text/Italique	.18mm	
12 pt. Century Text/Italique	.25mm	
18 pt. Century Text/Italique	.38mm	

A
B
C
D
E
F
G
H
I
J
S

TECHNICAL INFORMATION — DONNÉES TECHNIQUES

INK - ENCRE

PANTONE® * FORMUL (A)
(E)

COLOUR No. COULEUR : 5722-2404

— .1420 parts Pantone Process Yellow

— .0070 parts Pantone Mixing Black

— .8510 parts Pantone Extender

AIM SOLID DENSITY
DENSITÉ TEINTE PLATE VISÉE: 0.40 W/H 0.39 D/S

GRAYNESS - NETTETÉ : N/A

HUE ERROR - DÉVIATION DE : N/A
TEINTE

INK EFFICIENCY
EFFICACITÉ DE L'ENCRE : N/A

DENSITOMETRY / DENSITOMÉTRIE

• CHANNEL-SÉLECTION: YELLOW/JAUNE

• FILTER TYPE DE FILTRES: STATUS T

• FACTEUR n FACTOR: 2.7

* Pantone, Inc.'s check-standard trademark for colour reproduction and colour reproduction materials.

* La marque de Pantone, Inc. de contrôle uniforme pour la reproduction en couleur et les matériaux pour la reproduction en couleur.

CIE CHROMATICITY DIAGRAM(ME) DES CHROMATICITÉS CIE

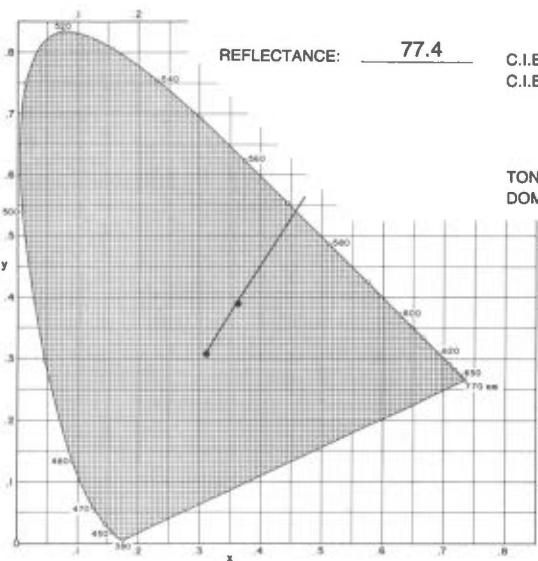

REFLECTANCE: 77.4 C.I.E. PURETÉ : 36%
C.I.E. PURITY

TON: 572
DOMINANT WAVELENGTH

Y: 47.4
X: 71.2
Z: 49.1

x: 0.360
y: 0.390

PAPER - PAPIER

GRADE / CATÉGORIE: W.S. NEW BRITE

TYPE: UNCOATED - NON COUCHÉ

REFLECTIVITÉ / REFLECTIVITY: 83%

OPACITÉ / OPACITY: 85.5%

% CONTRASTE/CONTRAST: 19%

PLATE - PLAQUE

SUBT. - SOUST.

TYPE: NEGATIVE

PRESS - PRESSE

• MEIHLE

• UNIT(É) #: LOWER/INFÉRIEURE

ID. PATCHES BLOCS IDEN.	% SCREEN TRAME	DENSITY DENSITÉ	% PRINT IMPRESSION
A	3	.09	2
B	6	.10	4
C	12	.12	13
D	22	.15	25
E	30	.18	33
F	40	.20	45
G	52	.24	56
H	66	.28	71
I	77	.30	81
J	87	.32	90
M	14	.13	81
N	27	.17	35
O	37	.20	45
P	51	.23	58
SOLID TEINTE PLATE	100	.37	100

The colour printed here was blended from, and should only be blended from PANTONE Basic Colours obtained from a PANTONE Licensed Printing Ink Manufacturer. Pantone, Inc. assumes no responsibility for the accuracy of the formulas or the colour reproduced.

La couleur ci-imprimée fut et devrait être mélangée seulement à partir des couleurs de base PANTONE obtenues d'un fabricant d'encre autorisé. La compagnie Pantone, Inc. n'assume aucune responsabilité quant à l'exactitude du mélange ou de la couleur obtenue.

RDD - DRD

COLOURS AND SCREENS

COULEURS ET TRAMES



BIANGULAR SCREENS — TRAMES BIANGULÉES

M

4 pt. Times Ten Roman	.08mm	
6 pt. Times Ten Roman	.13mm	
10 pt. Times Ten Roman	.18mm	
12 pt. Times Ten Roman	.25mm	
18 pt. Times Ten Roman	.38mm	

N

4 pt. Times Ten Roman	.08mm	
6 pt. Times Ten Roman	.13mm	
10 pt. Times Ten Roman	.18mm	
12 pt. Times Ten Roman	.25mm	
18 pt. Times Ten Roman	.38mm	

O

4 pt. Times Ten Roman	.08mm	
6 pt. Times Ten Roman	.13mm	
10 pt. Times Ten Roman	.18mm	
12 pt. Times Ten Roman	.25mm	
18 pt. Times Ten Roman	.38mm	

P

4 pt. Times Ten Roman	.08mm	
6 pt. Times Ten Roman	.13mm	
10 pt. Times Ten Roman	.18mm	
12 pt. Times Ten Roman	.25mm	
18 pt. Times Ten Roman	.38mm	

SOLID — TEINTE PLATE

4 pt. Times Ten Roman	.08mm	
6 pt. Times Ten Roman	.13mm	
10 pt. Times Ten Roman	.18mm	
12 pt. Times Ten Roman	.25mm	
18 pt. Times Ten Roman	.38mm	

A

B

C

D

E

F

G

H

I

J

S

TECHNICAL INFORMATION — DONNÉES TECHNIQUES

INK - ENCRE

PANTONE® * FORMUL (A/E)

COLOUR No. COULEUR : 5723-160

AIM SOLID DENSITY
DENSITÉ TEINTE PLATE VISÉE : 0.65 W/H 0.61 D/S

GRAYNESS - NETTETÉ : N/A

HUE ERROR - DÉVIATION DE : N/A
TEINTE

INK EFFICIENCY : N/A
EFFICACITÉ DE L'ENCRE

DENSITOMETRY / DENSITOMÉTRIE

• CHANNEL-SÉLECTION: YELLOW/JAUNE

• FILTER TYPE DE FILTRES: STATUS T

• FACTEUR n FACTOR: 2.7

* Pantone, Inc.'s check-standard trademark for colour reproduction and colour reproduction materials.

* La marque de Pantone, Inc. de contrôle uniforme pour la reproduction en couleur et les matériaux pour la reproduction en couleur.

CIE CHROMATICITY DIAGRAM(ME) DES CHROMATICITÉS CIE

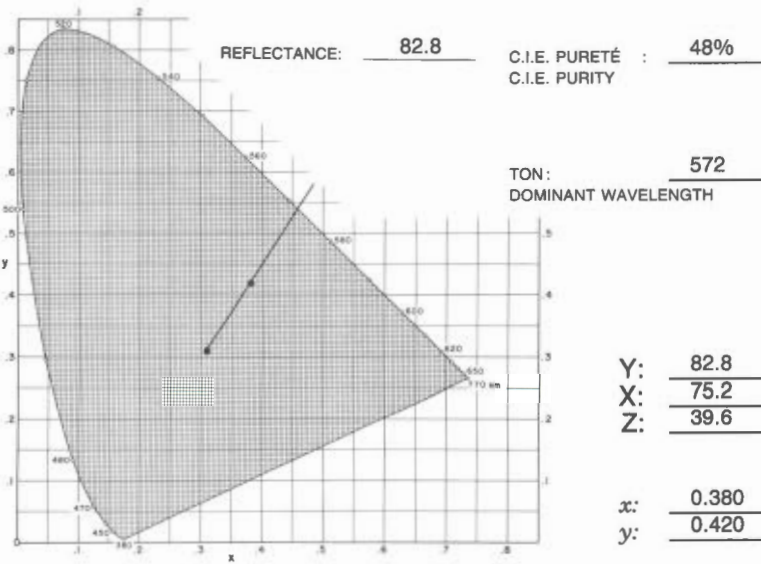

ID. PATCHES BLOCS IDEN.	% SCREEN TRAME	DENSITY DENSITÉ	% PRINT IMPRESSION
A	3	.12	5
B	6	.14	8
C	12	.18	18
D	22	.22	30
E	30	.26	39
F	40	.31	50
G	52	.36	63
H	66	.43	73
I	77	.47	84
J	87	.51	90
M	14	.19	21
N	27	.27	40
O	37	.30	50
P	51	.35	58
SOLID TEINTE PLATE	100	.60	100

PAPER - PAPIER

GRADE / CATÉGORIE: W.S. STANDARD

TYPE: UNCOATED - NON COUCHÉ

REFLECTIVITÉ / REFLECTIVITY: 83%

OPACITÉ / OPACITY: 89.5%

% CONTRASTE/CONTRAST: 25%

PLATE - PLAQUE

TYPE: SUBT. - SOUST.

TYPE: NEGATIVE

PRESS - PRESSE

• MEIHLE

• UNIT(É) #: LOWER/INFÉRIEURE

The colour printed here was blended from, and should only be blended from PANTONE Basic Colours obtained from a PANTONE Licensed Printing Ink Manufacturer.

Pantone, Inc. assumes no responsibility for the accuracy of the formulas or the colour reproduced. La couleur ci-imprimée fut et devrait être mélangée seulement à partir des couleurs de base PANTONE obtenues d'un fabricant d'encre autorisé. La compagnie Pantone, Inc. n'assume aucune responsabilité quant à l'exactitude du mélange ou de la couleur obtenue.

RDD - DRD

COLOURS AND SCREENS

COULEURS ET TRAMES

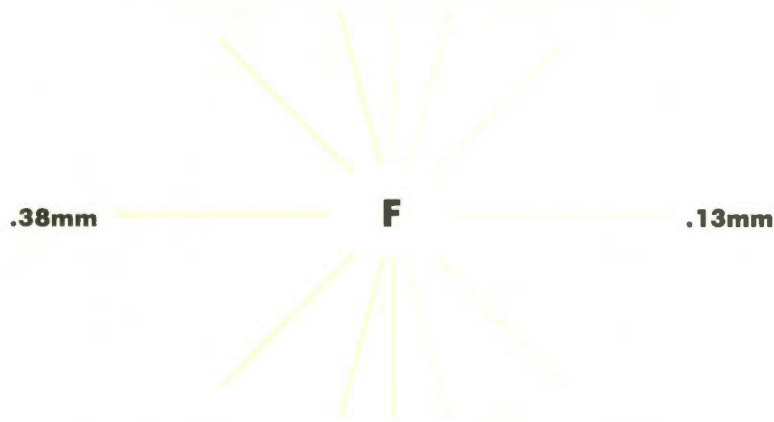

BIANGULAR SCREENS — TRAMES BIANGULÉES

M

8 pt. Century Text Italic/Italique	.08mm	
8 pt. Triumvirate Roman/Romain	.13mm	
10 pt. Futura Roman/Romain	.18mm	
12 pt. CG Trade Condensed/Condensé	.25mm	
	.38mm	

N

8 pt. Century Text Italic/Italique	.08mm	
8 pt. Futura Roman/Romain	.13mm	
10 pt. CG Trade Condensed/Condensé	.18mm	
12 pt. Cent. Text Italic/Italique	.25mm	
	.38mm	

O

8 pt. Century Text Italic/Italique	.08mm	
8 pt. CG Trade Condensed/Condensé	.13mm	
10 pt. Century Text Italic/Italique	.18mm	
12 pt. Trium. Rom/Romain	.25mm	
	.38mm	

P

8 pt. CG Trade Condensed/Condensé	.08mm	
8 pt. Century Text Italic/Italique	.13mm	
10 pt. Triumvirate Roman/Romain	.18mm	
12 pt. Futura Roman/Romain	.25mm	
	.38mm	

SOLID — TEINTE PLATE

8 pt. Century Text Italic/Italique	.08mm	
8 pt. Triumvirate Roman/Romain	.13mm	
10 pt. Futura Roman/Romain	.18mm	
12 pt. CG Trade Condensed/Condensé	.25mm	
	.38mm	

A
B
C
D
E
F
G
H
I
J
S

TECHNICAL INFORMATION — DONNÉES TECHNIQUES

INK - ENCRE

PANTONE® * FORMUL (A/E)

COLOUR No. COULEUR : 5723-160

GRAYNESS - NETTETÉ : N/A

HUE ERROR - DÉVIATION DE : N/A
TEINTE

INK EFFICIENCY : N/A
EFFICACITÉ DE L'ENCRE

AIM SOLID DENSITY : 0.65 W/H 0.63 D/S
DENSITÉ TEINTE PLATE VISÉE :

DENSITOMETRY / DENSITOMÉTRIE

• CHANNEL-SÉLECTION: YELLOW/JAUNE

• FILTER TYPE DE FILTRES: STATUS T

• FACTEUR n FACTOR: 2.7

* Pantone, Inc.'s check-standard trademark for colour reproduction and colour reproduction materials.

* La marque de Pantone, Inc. de contrôle uniforme pour la reproduction en couleur et les matériaux pour la reproduction en couleur.

CIE CHROMATICITY DIAGRAM(ME) DES CHROMATICITÉS CIE

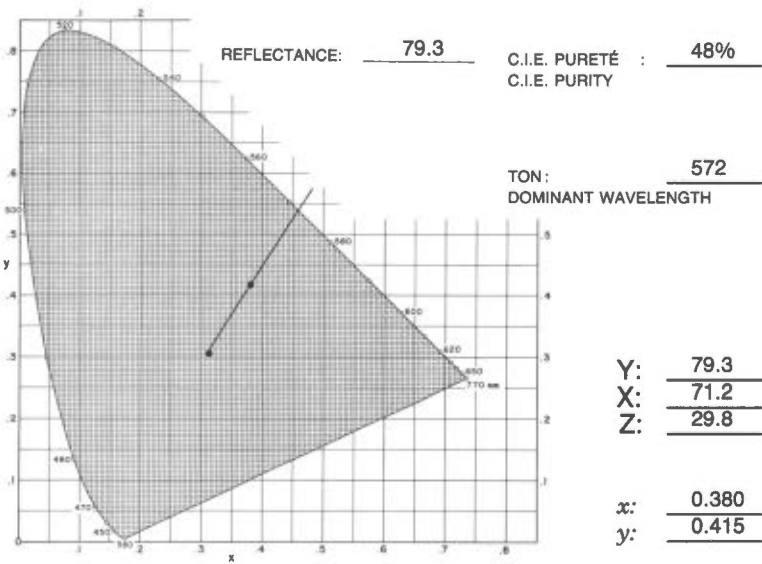

PAPER - PAPIER

GRADE / CATÉGORIE: W.S. NEW BRITE

TYPE: UNCOATED - NON COUCHÉ

REFLECTIVITÉ / REFLECTIVITY: 83.17%

OPACITÉ / OPACITY: 85.5%

% CONTRASTE/CONTRAST: 19%

PLATE - PLAQUE

SUBT. - SOUST.

TYPE: NEGATIVE

PRESS - PRESSE

• MEIHLE

• UNIT(É) #: LOWER/INFÉRIEURE

ID. PATCHES BLOCS IDEN.	% SCREEN FRAME	DENSITY DENSITÉ	% PRINT IMPRESSION
A	3	.09	3
B	6	.11	7
C	12	.14	15
D	22	.19	26
E	30	.23	36
F	40	.29	46
G	52	.34	59
H	66	.40	71
I	77	.47	81
J	87	.51	90
M	14	.17	20
N	27	.23	36
O	37	.28	46
P	51	.34	58
SOLID TEINTE PLATE	100	.55	100

The colour printed here was blended from, and should only be blended from PANTONE Basic Colours obtained from a PANTONE Licensed Printing Ink Manufacturer. Pantone, Inc. assumes no responsibility for the accuracy of the formulas or the colour reproduced.

La couleur ci-imprimée fut et devrait être mélangée seulement à partir des couleurs de base PANTONE obtenues d'un fabricant d'encre autorisé. La compagnie Pantone, Inc. n'assume aucune responsabilité quant à l'exactitude du mélange ou de la couleur obtenue.

0
8
m
m
1
3
m
m
1
5
m
m
2
5
m
m
3
8
m
m

COLOUR NO.
No. DE COULEUR 160

RDD - DRD

COLOURS AND SCREENS

COULEURS ET TRAMES

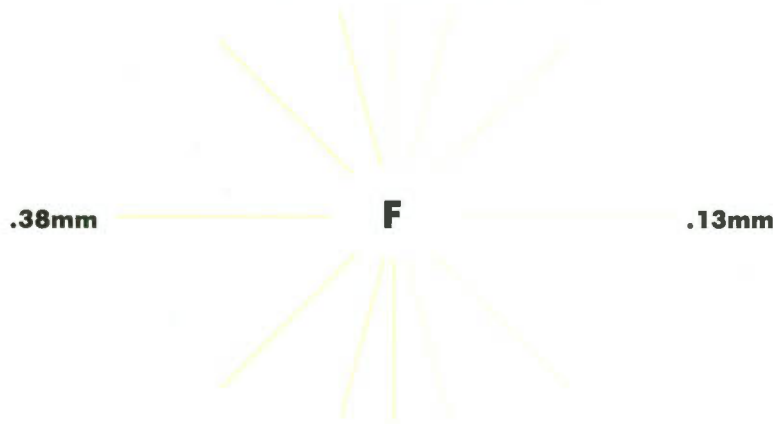

BIANGULAR SCREENS — TRAMES BIANGULÉES

M

8 pt. <i>Century Text Italic/Italique</i>	.08mm	
8 pt. <i>Futura Roman/Romain</i>	.13mm	
10 pt. <i>CG Trade Condensed/Condensé</i>	.18mm	
12 pt. <i>CG Trade Condensed/Condensé</i>	.25mm	
	.38mm	

N

8 pt. <i>Century Text Italic/Italique</i>	.08mm	
8 pt. <i>Futura Roman/Romain</i>	.13mm	
10 pt. <i>CG Trade Condensed/Condensé</i>	.18mm	
12 pt. <i>Cent. Text It/Italique</i>	.25mm	
	.38mm	

O

8 pt. <i>Century Text Italic/Italique</i>	.08mm	
8 pt. <i>CG Trade Condensed/Condensé</i>	.13mm	
10 pt. <i>Century Text Italic/Italique</i>	.18mm	
12 pt. <i>Trilum. Rom/Romain</i>	.25mm	
	.38mm	

P

8 pt. <i>CG Trade Condensed/Condensé</i>	.08mm	
8 pt. <i>Century Text Italic/Italique</i>	.13mm	
10 pt. <i>Triumvirate Roman/Romain</i>	.18mm	
12 pt. <i>Futura Roman/Romain</i>	.25mm	
	.38mm	

SOLID — TEINTE PLATE

8 pt. <i>Century Text Italic/Italique</i>	.08mm	
8 pt. <i>Triumvirate Roman/Romain</i>	.13mm	
10 pt. <i>Futura Roman/Romain</i>	.18mm	
12 pt. <i>CG Trade Condensed/Condensé</i>	.25mm	
	.38mm	

A

B

C

D

E

F

G

H

I

J

S

0
0
3
5
7
0
0
1
1
6

TECHNICAL INFORMATION — DONNÉES TECHNIQUES

INK - ENCRE

PANTONE® * FORMUL (A/E)

COLOUR No. COULEUR : 5731-162

AIM SOLID DENSITY
DENSITÉ TEINTE PLATE VISÉE : 1.00 W/H 0.95 D/S

GRAYNESS - NETTETÉ : N/A

HUE ERROR - DÉVIATION DE : N/A
TEINTE

INK EFFICIENCY : N/A
EFFICACITÉ DE L'ENCRE

DENSITOMETRY / DENSITOMÉTRIE

• CHANNEL-SÉLECTION: YELLOW/JAUNE

• FILTER TYPE DE FILTRES: STATUS T

• FACTEUR n FACTOR: 2.7

* Pantone, Inc.'s check-standard trademark for colour reproduction and colour reproduction materials.

* La marque de Pantone, Inc. de contrôle uniforme pour la reproduction en couleur et les matériaux pour la reproduction en couleur.

CIE CHROMATICITY DIAGRAM(ME) DES CHROMATICITÉS CIE

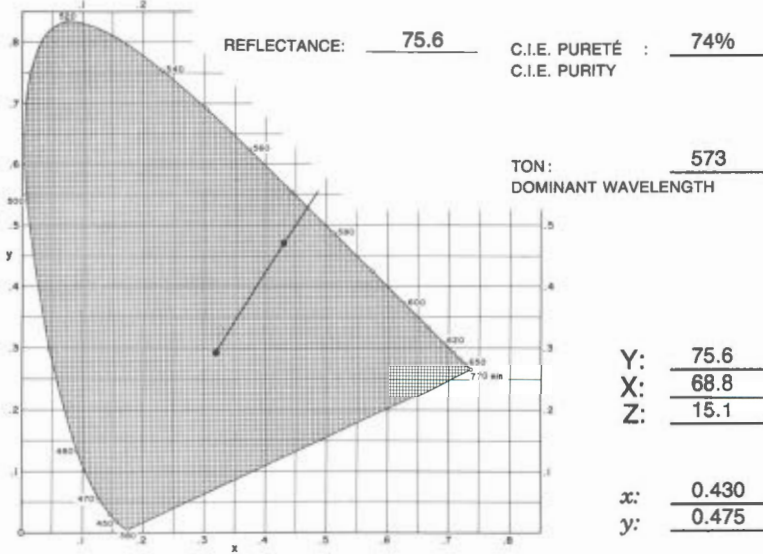

PAPER - PAPIER

GRADE / CATÉGORIE: W.S. STANDARD

TYPE: UNCOATED - NON COUCHÉ

REFLECTIVITÉ / REFLECTIVITY: 79%

OPACITÉ / OPACITY: 87%

% CONTRASTE/CONTRAST: 13%

PLATE - PLAQUE

TYPE: SUBT. - SOUST.

TYPE: NEGATIVE

PRESS - PRESSE

• MEIHLE

• UNIT(É) #: LOWER/INFÉRIEURE

ID. PATCHES BLOCS IDEN.	% SCREEN TRAME	DENSITY DENSITÉ	% PRINT IMPRESSION
A	3	.14	7
B	6	.16	12
C	12	.20	19
D	22	.27	29
E	30	.34	41
F	40	.43	52
G	52	.54	68
H	66	.66	81
I	77	.76	90
J	87	.81	95
M	14	.25	26
N	27	.37	43
O	37	.43	51
P	51	.52	64
SOLID TEINTE PLATE	100	.87	100

The colour printed here was blended from, and should only be blended from PANTONE Basic Colours obtained from a PANTONE Licensed Printing Ink Manufacturer. Pantone, Inc. assumes no responsibility for the accuracy of the formulas or the colour reproduced.

La couleur ci-imprimée fut et devrait être mélangée seulement à partir des couleurs de base PANTONE obtenues d'un fabricant d'encre autorisé. La compagnie Pantone, Inc. n'assume aucune responsabilité quant à l'exactitude du mélange ou de la couleur obtenue.

RDD - DRD

COLOURS AND SCREENS

COULEURS ET TRAMES

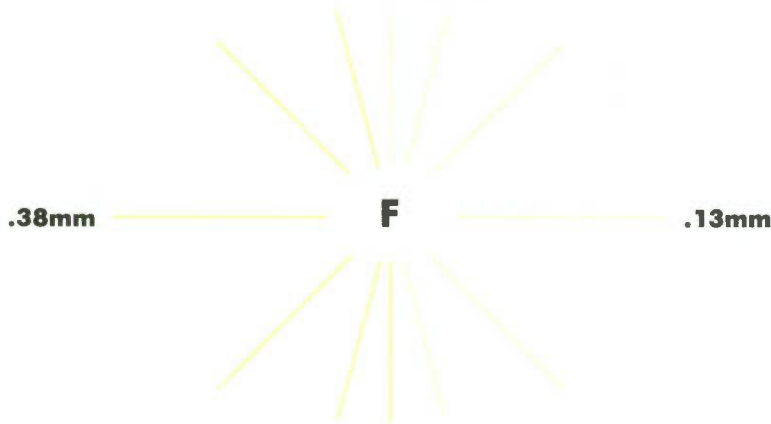

BIANGULAR SCREENS — TRAMES BIANGULÉES

M

4 pt. Triumvirate Roman/Romain	.06mm	
8 pt. Triumvirate Roman/Romain	.13mm	
10 pt. Futura Roman/Romain	.18mm	
12 pt. CG Trade Condensed/Condensé	.25mm	
	.38mm	

N

4 pt. Triumvirate Roman/Romain	.06mm	
8 pt. Futura Roman/Romain	.13mm	
10 pt. CG Trade Condensed/Condensé	.18mm	
12 pt. Cent. Text It./Italique	.25mm	
	.38mm	

O

4 pt. Futura Roman/Romain	.06mm	
8 pt. CG Trade Condensed/Condensé	.13mm	
10 pt. Century Text Italic/Italique	.18mm	
12 pt. Trium. Rom./Romain	.25mm	
	.38mm	

P

4 pt. CG Trade Condensed/Condensé	.06mm	
8 pt. Century Text Italic/Italique	.13mm	
10 pt. Triumvirate Roman/Romain	.18mm	
12 pt. Futura Roman/Romain	.25mm	
	.38mm	

SOLID — TEINTE PLATE

4 pt. Century Text Italic/Italique	.06mm	
8 pt. Triumvirate Roman/Romain	.13mm	
10 pt. Futura Roman/Romain	.18mm	
12 pt. CG Trade Condensed/Condensé	.25mm	
	.38mm	

A

B

C

D

E

F

G

H

I

J

S

TECHNICAL INFORMATION — DONNÉES TECHNIQUES

INK - ENCRE

PANTONE® * FORMUL (A/E)

COLOUR No. COULEUR : 5731-162

AIM SOLID DENSITY
DENSITÉ TEINTE PLATE VISÉE : 0.95 W/H 0.89 D/S

GRAYNESS - NETTETÉ : N/A

HUE ERROR - DÉVIATION DE : N/A
TEINTE

INK EFFICIENCY : N/A
EFFICACITÉ DE L'ENCRE

DENSITOMETRY / DENSITOMÉTRIE

- CHANNEL-SÉLECTION: YELLOW/JAUNE
- FILTER TYPE DE FILTRES: STATUS T
- FACTEUR n FACTOR: 2.7

* Pantone, Inc.'s check-standard trademark for colour reproduction and colour reproduction materials.

* La marque de Pantone, Inc. de contrôle uniforme pour la reproduction en couleur et les matériaux pour la reproduction en couleur.

CIE CHROMATICITY DIAGRAM(ME) DES CHROMATICITÉS CIE

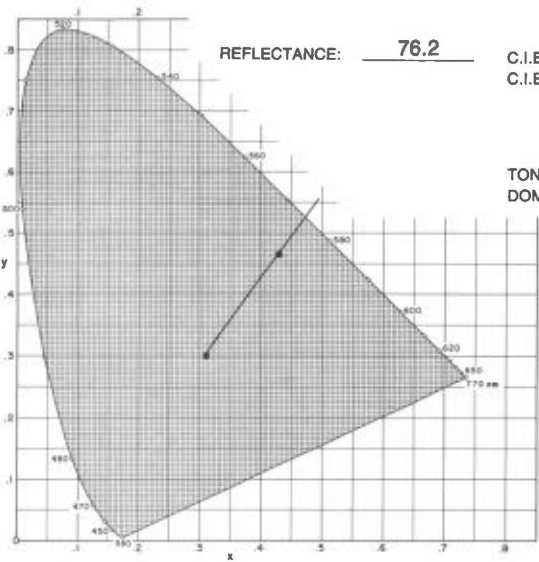

REFLECTANCE: 76.2 C.I.E. PURETÉ : 72%
C.I.E. PURITY :

TON: 573
DOMINANT WAVELENGTH

Y: 76.2
X: 69.1
Z: 16.8

x: 0.425
y: 0.470

ID. PATCHES BLOCS IDEN.	% SCREEN TRAME	DENSITY DENSITÉ	% PRINT IMPRESSION
A	3	.11	6
B	6	.15	12
C	12	.20	20
D	22	.27	31
E	30	.35	42
F	40	.44	55
G	52	.55	68
H	66	.67	80
I	77	.76	88
J	87	.79	95
M	14	.24	27
N	27	.36	45
O	37	.43	53
P	51	.54	67
SOLID TEINTE PLATE	100	.85	100

PAPER - PAPIER

GRADE / CATÉGORIE: W.S. NEW BRITE

TYPE: UNCOATED - NON COUCHÉ

REFLECTIVITÉ / REFLECTIVITY: 83%

OPACITÉ / OPACITY: 85.5%

% CONTRASTE/CONTRAST: 11%

PLATE - PLAQUE

SUBT. - SOUST.

TYPE: NEGATIVE

PRESS - PRESSE

• MEIHLE

• UNIT(É) #: LOWER/INFÉRIEURE

The colour printed here was blended from, and should only be blended from PANTONE Basic Colours obtained from a PANTONE Licensed Printing Ink Manufacturer. Pantone, Inc. assumes no responsibility for the accuracy of the formulas or the colour reproduced.

La couleur ci-imprimée fut et devrait être mélangée seulement à partir des couleurs de base PANTONE obtenues d'un fabricant d'encre autorisé. La compagnie Pantone, Inc. n'assume aucune responsabilité quant à l'exactitude du mélange ou de la couleur obtenue.

RDD - DRD

COLOURS AND SCREENS

COULEURS ET TRAMES

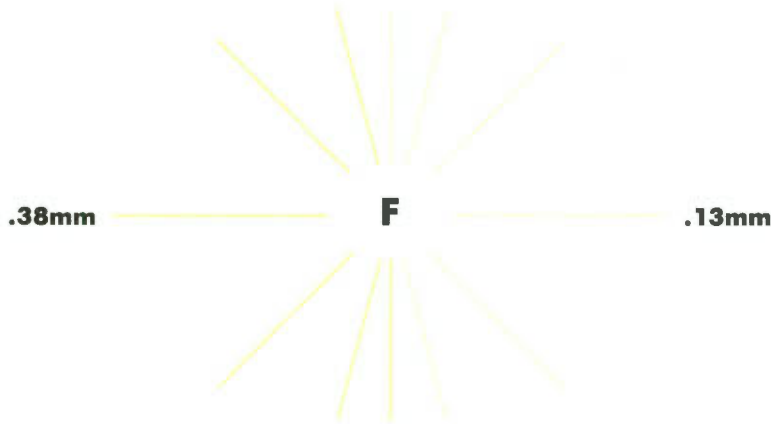

BIANGULAR SCREENS — TRAMES BIANGULÉES

M

4 pt. Triumvirate Roman/Romain	.08mm	
6 pt. Futura Roman/Romain	.13mm	
10 pt. CG Trade Condensed/Condensé	.18mm	
12 pt. Century Text Italic/Italique	.25mm	
	.38mm	

N

4 pt. Triumvirate Roman/Romain	.08mm	
6 pt. Futura Roman/Romain	.13mm	
10 pt. CG Trade Condensed/Condensé	.18mm	
12 pt. Century Text Italic/Italique	.25mm	
	.38mm	

O

4 pt. Futura Roman/Romain	.08mm	
6 pt. CG Trade Condensed/Condensé	.13mm	
10 pt. Century Text Italic/Italique	.18mm	
12 pt. Triumvirate Roman/Romain	.25mm	
	.38mm	

P

4 pt. CG Trade Condensed/Condensé	.08mm	
6 pt. Century Text Italic/Italique	.13mm	
10 pt. Triumvirate Roman/Romain	.18mm	
12 pt. Futura Roman/Romain	.25mm	
	.38mm	

SOLID — TEINTE PLATE

4 pt. Century Text Italic/Italique	.08mm	
6 pt. Triumvirate Roman/Romain	.13mm	
10 pt. Futura Roman/Romain	.18mm	
12 pt. CG Trade Condensed/Condensé	.25mm	
	.38mm	

A

B

C

D

E

F

G

H

I

J

S

TECHNICAL INFORMATION — DONNÉES TECHNIQUES

INK - ENCRE

PANTONE® * FORMUL (A/E)

COLOUR No. COULEUR : 5814-168

AIM SOLID DENSITY
DENSITÉ TEINTE PLATE VISÉE : 0.85 W/H 0.78 D/S

GRAYNESS - NETTETÉ : N/A

HUE ERROR - DÉVIATION DE : N/A
TEINTE

INK EFFICIENCY : N/A
EFFICACITÉ DE L'ENCRE

DENSITOMETRY / DENSITOMÉTRIE

- CHANNEL-SÉLECTION: YELLOW/JAUNE
- FILTER TYPE DE FILTRES: STATUS T
- FACTEUR n FACTOR: 2.7

* Pantone, Inc.'s check-standard trademark for colour reproduction and colour reproduction materials.

* La marque de Pantone, Inc. de contrôle uniforme pour la reproduction en couleur et les matériaux pour la reproduction en couleur.

CIE CHROMATICITY DIAGRAM(ME) DES CHROMATICITÉS CIE

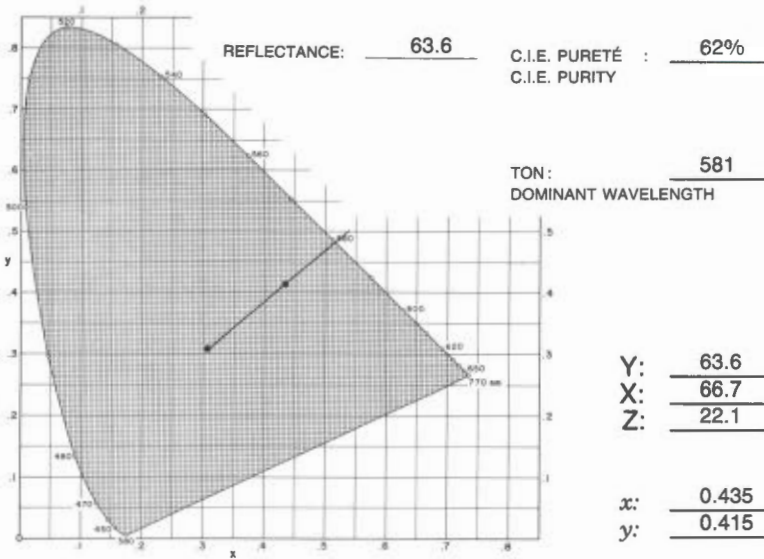

PAPER - PAPIER

GRADE / CATÉGORIE: W.S. STANDARD

TYPE: UNCOATED - NON COUCHÉ

REFLECTIVITÉ / REFLECTIVITY: 79%

OPACITÉ / OPACITY: 87%

% CONTRASTE/CONTRAST: 17%

PLATE - PLAQUE

SUBT. - SOUST.

TYPE: NEGATIVE

PRESS - PRESSE

• MEIHLE

• UNIT(É) #: LOWER/INFÉRIEURE

ID. PATCHES BLOCS IDEN.	% SCREEN TRAME	DENSITY DENSITÉ	% PRINT IMPRESSION
A	3	.12	4
B	6	.14	8
C	12	.18	16
D	22	.24	27
E	30	.29	36
F	40	.37	49
G	52	.46	62
H	66	.56	73
I	77	.63	85
J	87	.67	92
M	14	.20	19
N	27	.31	38
O	37	.36	46
P	51	.45	54
SOLID TEINTE PLATE	100	.76	100

The colour printed here was blended from, and should only be blended from PANTONE Basic Colours obtained from a PANTONE Licensed Printing Ink Manufacturer. Pantone, Inc. assumes no responsibility for the accuracy of the formulas or the colour reproduced.

La couleur ci-imprimée fut et devrait être mélangée seulement à partir des couleurs de base PANTONE obtenues d'un fabricant d'encre autorisé. La compagnie Pantone, Inc. n'assume aucune responsabilité quant à l'exactitude du mélange ou de la couleur obtenue.

RDD - DRD

COLOURS AND SCREENS

COULEURS ET TRAMES

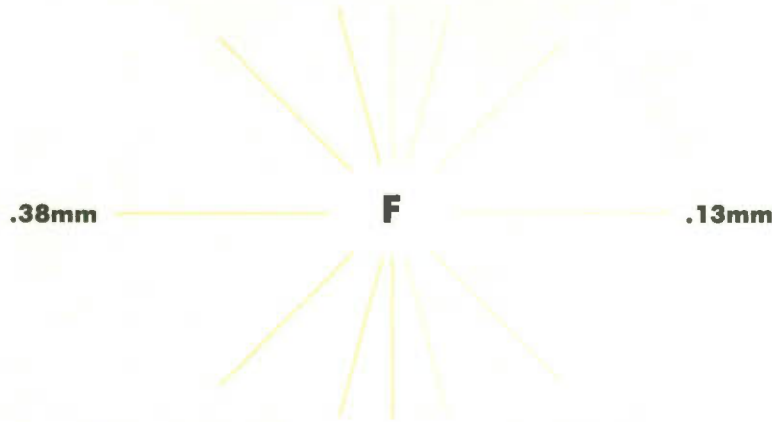

BIANGULAR SCREENS — TRAMES BIANGULÉES

M

6 pt. Century Text <i>Italie/Italique</i>	.08mm	
8 pt. Triumvirate Roman/Romain	.13mm	
10 pt. Futura Roman/Romain	.18mm	
12 pt. CG Trade Condensed/Condensé	.25mm	
	.38mm	

N

6 pt. Century Text <i>Italie/Italique</i>	.08mm	
8 pt. Futura Roman/Romain	.13mm	
10 pt. CG Trade Condensed/Condensé	.18mm	
12 pt. Cent. Text <i>It./Italique</i>	.25mm	
	.38mm	

O

6 pt. Century Roman/Romain	.08mm	
8 pt. CG Trade Condensed/Condensé	.13mm	
10 pt. Century Text <i>Italie/Italique</i>	.18mm	
12 pt. Trium. Rom./Romain	.25mm	
	.38mm	

P

6 pt. CG Trade Condensed/Condensé	.08mm	
8 pt. Century Text <i>Italie/Italique</i>	.13mm	
10 pt. Triumvirate Roman/Romain	.18mm	
12 pt. Futura Roman/Romain	.25mm	
	.38mm	

SOLID — TEINTE PLATE

6 pt. Century Text <i>Italie/Italique</i>	.08mm	
8 pt. Triumvirate Roman/Romain	.13mm	
10 pt. Futura Roman/Romain	.18mm	
12 pt. CG Trade Condensed/Condensé	.25mm	
	.38mm	

A

B

C

D

E

F

G

H

I

J

S

TECHNICAL INFORMATION — DONNÉES TECHNIQUES

INK - ENCRE

PANTONE® * FORMUL (A/E)

COLOUR No. COULEUR : 5814-168

AIM SOLID DENSITY
DENSITÉ TEINTE PLATE VISÉE : 0.87 W/H 0.79 D/S

GRAYNESS - NETTETÉ : N/A

HUE ERROR - DÉVIATION DE : N/A
TEINTE

INK EFFICIENCY : N/A
EFFICACITÉ DE L'ENCRE

DENSITOMETRY / DENSITOMÉTRIE

• CHANNEL-SÉLECTION: YELLOW/JAUNE

• FILTER TYPE DE FILTRES: STATUS T

• FACTEUR n FACTOR: 2.7

* Pantone, Inc.'s check-standard trademark for colour reproduction and colour reproduction materials.

* La marque de Pantone, Inc. de contrôle uniforme pour la reproduction en couleur et les matériaux pour la reproduction en couleur.

CIE CHROMATICITY DIAGRAM(ME) DES CHROMATICITÉS CIE

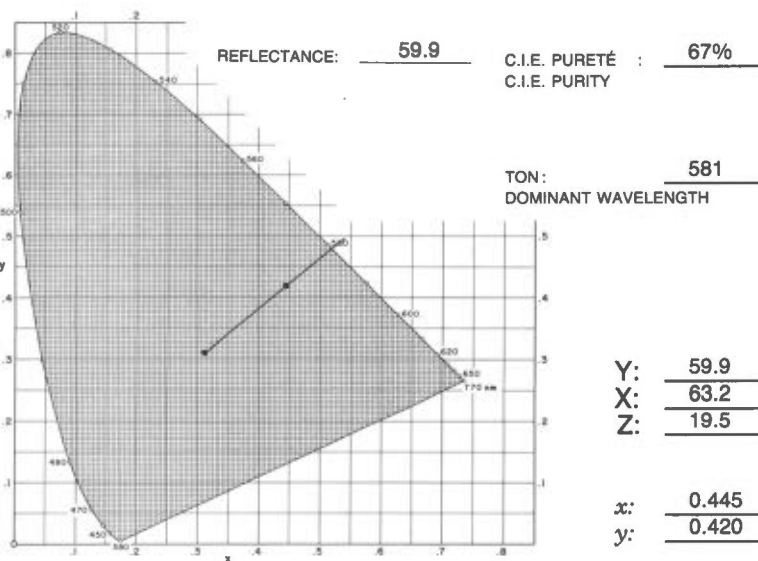

ID. PATCHES BLOCS IDEN.	% SCREEN TRAME	DENSITY DENSITÉ	% PRINT IMPRESSION
A	3	.11	4
B	6	.13	9
C	12	.17	18
D	22	.24	29
E	30	.29	37
F	40	.38	53
G	52	.46	62
H	66	.56	78
I	77	.61	88
J	87	.69	96
M	14	.20	21
N	27	.30	37
O	37	.36	48
P	51	.44	62
SOLID TEINTE PLATE	100	.74	100

PAPER - PAPIER

GRADE / CATÉGORIE: W.S. NEW BRITE

TYPE: UNCOATED - NON COUCHÉ

REFLECTIVITÉ / REFLECTIVITY: 81%

OPACITÉ / OPACITY: 85.5%

% CONTRASTE/CONTRAST: 23%

PLATE - PLAQUE

SUBT. - SOUST.

TYPE: NEGATIVE

PRESS - PRESSE

• MEIHLE

• UNIT(É) #: LOWER/INFÉRIEURE

The colour printed here was blended from, and should only be blended from PANTONE Basic Colours obtained from a PANTONE Licensed Printing Ink Manufacturer. Pantone, Inc. assumes no responsibility for the accuracy of the formulas or the colour reproduced.

La couleur ci-imprimée fut et devrait être mélangée seulement à partir des couleurs de base PANTONE obtenues d'un fabricant d'encre autorisé. La compagnie Pantone, Inc. n'assume aucune responsabilité quant à l'exactitude du mélange ou de la couleur obtenue.

COLOUR NO. 168

COLOUR NO. 168
No. DE COULEUR 168

RDD - DRD

COLOURS AND SCREENS

COULEURS ET TRAMES

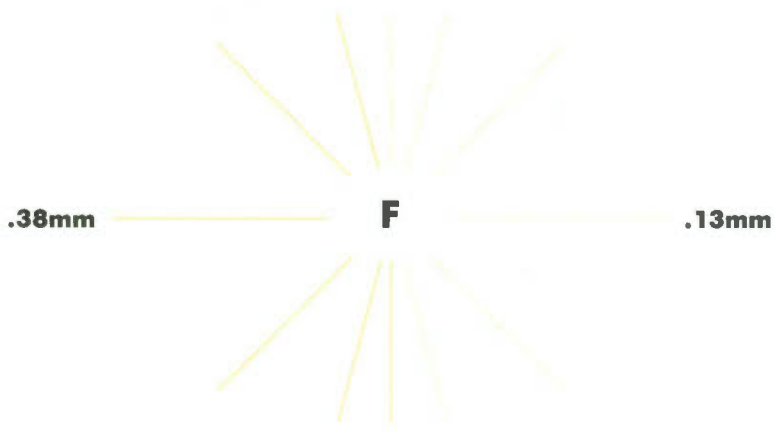

BIANGULAR SCREENS — TRAMES BIANGULÉES

M

6 pt. Century Text Italic/Italique	.08mm	
8 pt. Triumvirate Roman/Romain	.13mm	
10 pt. Futura Roman/Romain	.18mm	
12 pt. CG Trade Condensed/Condensé	.25mm	

N

6 pt. Century Text Italic/Italique	.08mm	
8 pt. Futura Roman/Romain	.13mm	
10 pt. CG Trade Condensed/Condensé	.18mm	
12 pt. Cent. Text It/Italique	.25mm	

O

6 pt. Futura Roman/Romain	.08mm	
8 pt. CG Trade Condensed/Condensé	.13mm	
10 pt. Century Text Italic/Italique	.18mm	
12 pt. Trium. Rom./Romain	.25mm	

P

6 pt. CG Trade Condensed/Condensé	.08mm	
8 pt. Century Text Italic/Italique	.13mm	
10 pt. Triumvirate Roman/Romain	.18mm	
12 pt. Futura Roman/Romain	.25mm	

SOLID — TEINTE PLATE

6 pt. Century Text Italic/Italique	.08mm	
8 pt. Triumvirate Roman/Romain	.13mm	
10 pt. Futura Roman/Romain	.18mm	
12 pt. CG Trade Condensed/Condensé	.25mm	

A
B
C
D
E
F
G
H
I
J
S



0 0 0 0
8 8 7 6

TECHNICAL INFORMATION — DONNÉES TECHNIQUES

INK - ENCRE

PANTONE® * FORMUL (A/E)

COLOUR No. COULEUR : 5880-167

AIM SOLID DENSITY
DENSITÉ TEINTE PLATE VISÉE : 0.88 W/H 0.78 D/S

GRAYNESS - NETTETÉ : N/A

HUE ERROR - DÉVIATION DE : N/A
TEINTE

INK EFFICIENCY : N/A
EFFICACITÉ DE L'ENCRE

DENSITOMETRY / DENSITOMÉTRIE

• CHANNEL-SÉLECTION: YELLOW/JAUNE

• FILTER TYPE DE FILTRES: STATUS T

• FACTEUR n FACTOR: 2.7

* Pantone, Inc.'s check-standard trademark for colour reproduction and colour reproduction materials.

* La marque de Pantone, Inc. de contrôle uniforme pour la reproduction en couleur et les matériaux pour la reproduction en couleur.

CIE CHROMATICITY DIAGRAM(ME) DES CHROMATICITÉS CIE

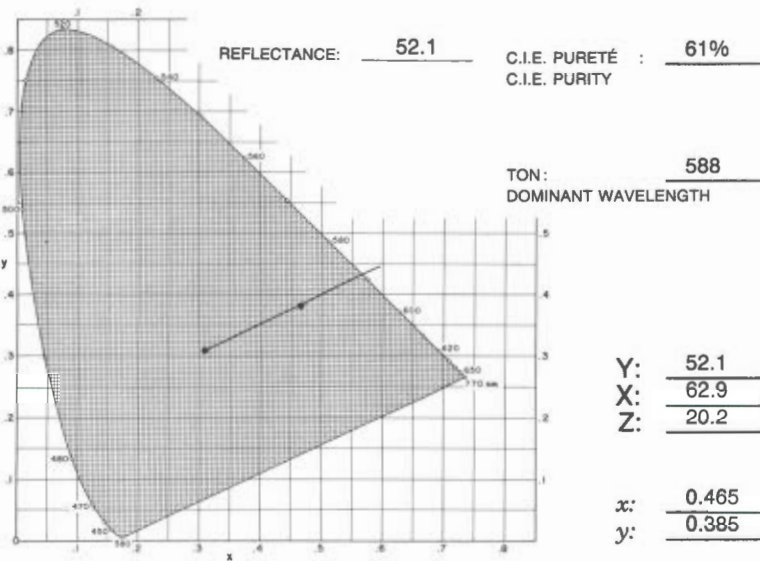

ID. PATCHES BLOCS IDEN.	% SCREEN TRAME	DENSITY DENSITÉ	% PRINT IMPRESSION
A	3	.13	4
B	6	.15	8
C	12	.19	16
D	22	.25	26
E	30	.31	35
F	40	.39	48
G	52	.48	61
H	66	.57	70
I	77	.64	79
J	87	.70	88
M	14	.22	20
N	27	.32	38
O	37	.39	46
P	51	.46	59
SOLID TEINTE PLATE	100	.81	100

PAPER - PAPIER

GRADE / CATÉGORIE: W.S. STANDARD

TYPE: UNCOATED - NON COUCHÉ

REFLECTIVITÉ / REFLECTIVITY: 79%

OPACITÉ / OPACITY: 87%

% CONTRASTE/CONTRAST: 23%

PLATE - PLAQUE

SUBT. - SOUST.

TYPE: NEGATIVE

PRESS - PRESSE

• MEIHLE

• UNIT(É) #: LOWER/INFÉRIEURE

The colour printed here was blended from, and should only be blended from PANTONE Basic Colours obtained from a PANTONE Licensed Printing Ink Manufacturer. Pantone, Inc. assumes no responsibility for the accuracy of the formulas or the colour reproduced.

La couleur ci-imprimée fut et devrait être mélangée seulement à partir des couleurs de base PANTONE obtenues d'un manufacturier d'encre autorisé. La compagnie Pantone, Inc. n'assume aucune responsabilité quant à l'exactitude du mélange ou de la couleur obtenue.

RDD - DRD

COLOURS AND SCREENS

COULEURS ET TRAMES

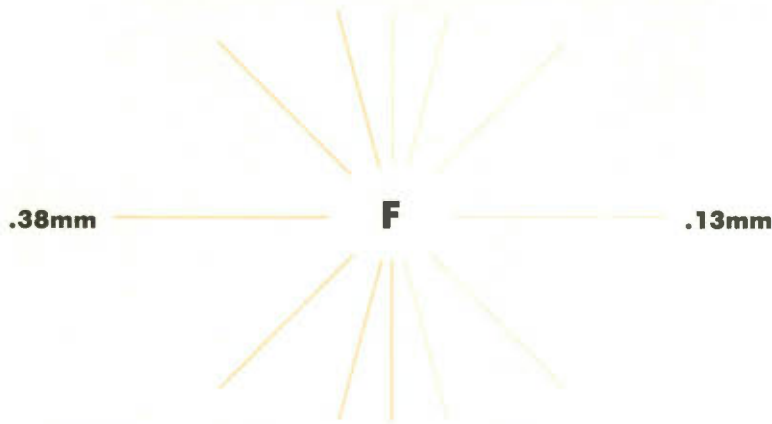

BIANGULAR SCREENS — TRAMES BIANGULÉES

M

6 pt. Triumvirate Roman/Romain
8 pt. Futura Roman/Romain
10 pt. Futura Condensed/Condensé
12 pt. CG Trade Condensed/Condensé



N

6 pt. Triumvirate Roman/Romain
8 pt. Futura Roman/Romain
10 pt. CG Trade Condensed/Condensé
12 pt. Cent. Text It/Italique



O

6 pt. Futura Roman/Romain
8 pt. CG Trade Condensed/Condensé
10 pt. Century Text Italic/Italique
12 pt. Trium. Rom/Romain



P

6 pt. CG Trade Condensed/Condensé
8 pt. Century Text Italic/Italique
10 pt. Triumvirate Roman/Romain
12 pt. Futura Roman/Romain



SOLID — TEINTE PLATE

6 pt. Century Text Italic/Italique
8 pt. Triumvirate Roman/Romain
10 pt. Futura Roman/Romain
12 pt. CG Trade Condensed/Condensé



A
B
C
D
E
F
G
H
I
J
S

TECHNICAL INFORMATION — DONNÉES TECHNIQUES

INK - ENCRE

PANTONE® * FORMUL (A/E)

COLOUR No. COULEUR : 5880-167

AIM SOLID DENSITY
DENSITÉ TEINTE PLATE VISÉE : 0.90 W/H 0.83 D/S

GRAYNESS - NETTETÉ : N/A

HUE ERROR - DÉVIATION DE : N/A
TEINTE

INK EFFICIENCY
EFFICACITÉ DE L'ENCRE : N/A

DENSITOMETRY / DENSITOMÉTRIE

• CHANNEL-SÉLECTION: YELLOW/JAUNE

• FILTER TYPE DE FILTRES: STATUS T

• FACTEUR n FACTOR: 2.7

* Pantone, Inc.'s check-standard trademark for colour reproduction and colour reproduction materials.
* La marque de Pantone, Inc. de contrôle uniforme pour la reproduction en couleur et les matériaux pour la reproduction en couleur.

CIE CHROMATICITY DIAGRAM(ME) DES CHROMATICITÉS CIE

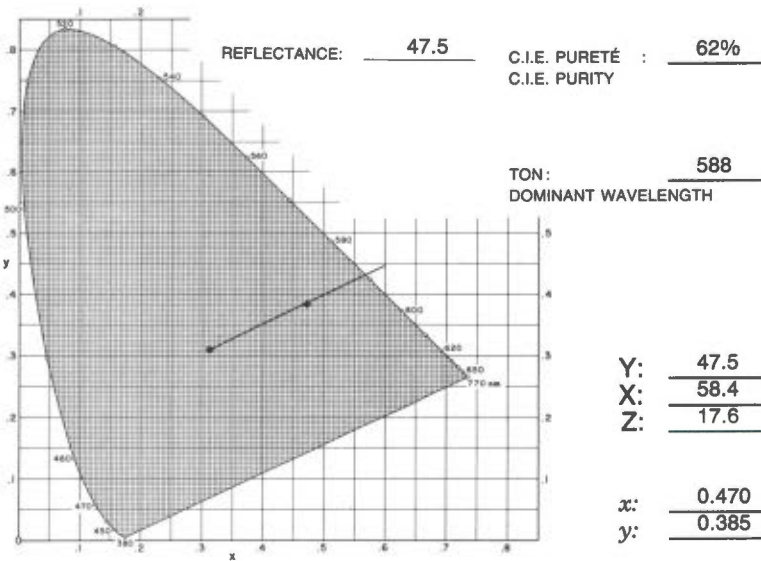

ID. PATCHES BLOCS IDEN.	% SCREEN TRAME	DENSITY DENSITÉ	% PRINT IMPRESSION
A	3	.12	3
B	6	.14	6
C	12	.18	15
D	22	.25	27
E	30	.32	37
F	40	.42	47
G	52	.47	57
H	66	.59	72
I	77	.64	79
J	87	.73	88
M	14	.21	20
N	27	.32	37
O	37	.38	45
P	51	.46	58
SOLID TEINTE PLATE	100	.79	100

PAPER - PAPIER

GRADE / CATÉGORIE: W.S. NEW BRITE

TYPE: UNCOATED - NON COUCHÉ

REFLECTIVITÉ / REFLECTIVITY: 83%

OPACITÉ / OPACITY: 85.5%

% CONTRASTE/CONTRAST: 19%

PLATE - PLAQUE

SUBT. - SOUST.

TYPE: NEGATIVE

PRESS - PRESSE

• MEIHLE

• UNIT(É) #: LOWER/INFÉRIEURE

The colour printed here was blended from, and should only be blended from PANTONE Basic Colours obtained from a PANTONE Licensed Printing Ink Manufacturer.
Pantone, Inc. assumes no responsibility for the accuracy of the formulas or the colour reproduced.

La couleur ci-imprimée fut et devrait être mélangée seulement à partir des couleurs de base PANTONE obtenues d'un manufacturier d'encre autorisé.
La compagnie Pantone, Inc. n'assume aucune responsabilité quant à l'exactitude du mélange ou de la couleur obtenue.

COULEUR
NO. DE COULEUR
167

COLOUR NO. 167
No. DE COULEUR 167

RDD - DRD

COLOURS AND SCREENS

COULEURS ET TRAMES

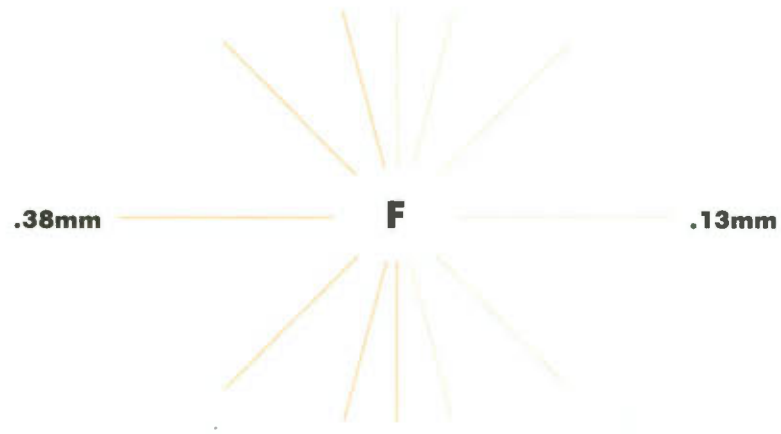

BIANGULAR SCREENS — TRAMES BIANGULÉES

M

6 pt. Triumvirate Roman/Romain	.08mm	
8 pt. Futura Roman/Romain	.13mm	
10 pt. CG Trade Condensed/Condensé	.18mm	
12 pt. Century Text Italic/Italique	.25mm	
	.38mm	

N

6 pt. Triumvirate Roman/Romain	.08mm	
8 pt. Futura Roman/Romain	.13mm	
10 pt. CG Trade Condensed/Condensé	.18mm	
12 pt. Century Text Italic/Italique	.25mm	
	.38mm	

O

6 pt. Futura Roman/Romain	.08mm	
8 pt. CG Trade Condensed/Condensé	.13mm	
10 pt. Century Text Italic/Italique	.18mm	
12 pt. Triumvirate Roman/Romain	.25mm	
	.38mm	

P

6 pt. CG Trade Condensed/Condensé	.08mm	
8 pt. Century Text Italic/Italique	.13mm	
10 pt. Triumvirate Roman/Romain	.18mm	
12 pt. Futura Roman/Romain	.25mm	
	.38mm	

SOLID — TEINTE PLATE

6 pt. Century Text Italic/Italique	.08mm	
8 pt. Triumvirate Roman/Romain	.13mm	
10 pt. Futura Roman/Romain	.18mm	
12 pt. CG Trade Condensed/Condensé	.25mm	
	.38mm	

A
B
C
D
E
F
G
H
I
J
S

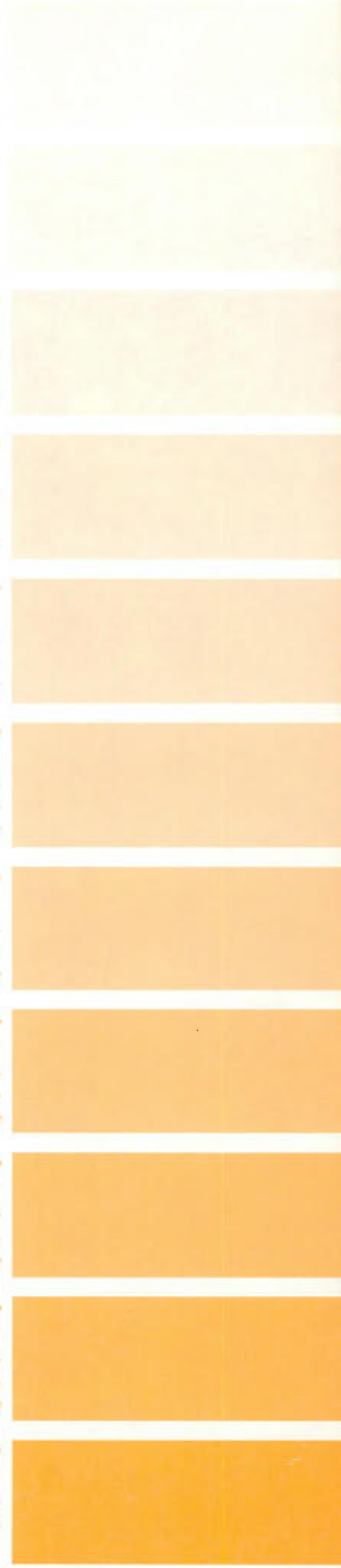

0000
0000
0000
0000
0000
0000
0000
0000

TECHNICAL INFORMATION — DONNÉES TECHNIQUES

INK - ENCRE

PANTONE® * FORMUL (A/E)

COLOUR No. COULEUR : 5880-167

GRAYNESS - NETTETÉ : N/A

AIM SOLID DENSITY : 0.92 W/H 0.88 D/S
 DENSITÉ TEINTE PLATE VISÉE :

HUE ERROR - DÉVIATION DE : N/A
 TEINTE

DENSITOMETRY / DENSITOMÉTRIE

INK EFFICIENCY : N/A
 EFFICACITÉ DE L'ENCRE

• CHANNEL-SÉLECTION: YELLOW/JAUNE

• FILTER TYPE DE FILTRES: STATUS T

• FACTEUR n FACTOR: 2.7

* Pantone, Inc.'s check-standard trademark for colour reproduction and colour reproduction materials.
 * La marque de Pantone, Inc. de contrôle uniforme pour la reproduction en couleur et les matériaux pour la reproduction en couleur.

CIE CHROMATICITY DIAGRAM(ME) DES CHROMATICITÉS CIE

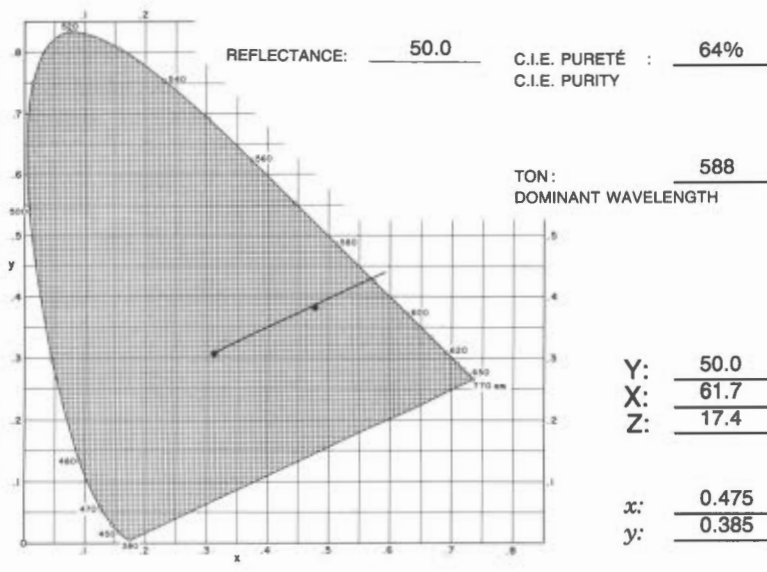

ID. PATCHES BLOCS IDEN.	% SCREEN TRAME	DENSITY DENSITÉ	% PRINT IMPRESSION
A	3	.13	5
B	6	.14	9
C	12	.19	19
D	22	.24	23
E	30	.31	32
F	40	.38	43
G	52	.45	53
H	66	.55	66
I	77	.65	78
J	87	.72	87
M	14	.21	17
N	27	.31	33
O	37	.36	42
P	51	.46	53
SOLID TEINTE PLATE	100	.85	100

PAPER - PAPIER

PLATE - PLAQUE

GRADE / CATÉGORIE: CHART

SUBT. - SOUST.

TYPE: UNCOATED - NON COUCHÉ

TYPE: NEGATIVE

REFLECTIVITÉ / REFLECTIVITY: 79%

PRESS - PRESSE

OPACITÉ / OPACITY: 96.5%

• MEIHLE

% CONTRASTE/CONTRAST: 24%

• UNIT(É) #: LOWER/INFÉRIEURE

The colour printed here was blended from, and should only be blended from PANTONE Basic Colours obtained from a PANTONE Licensed Printing Ink Manufacturer.
 Pantone, Inc. assumes no responsibility for the accuracy of the formulas or the colour reproduced.

La couleur ci-imprimée fut et devrait être mélangée seulement à partir des couleurs de base PANTONE obtenues d'un fabricant d'encre autorisé.
 La compagnie Pantone, Inc. n'assume aucune responsabilité quant à l'exactitude du mélange ou de la couleur obtenue.

RDD - DRD

COLOURS AND SCREENS

COULEURS ET TRAMES

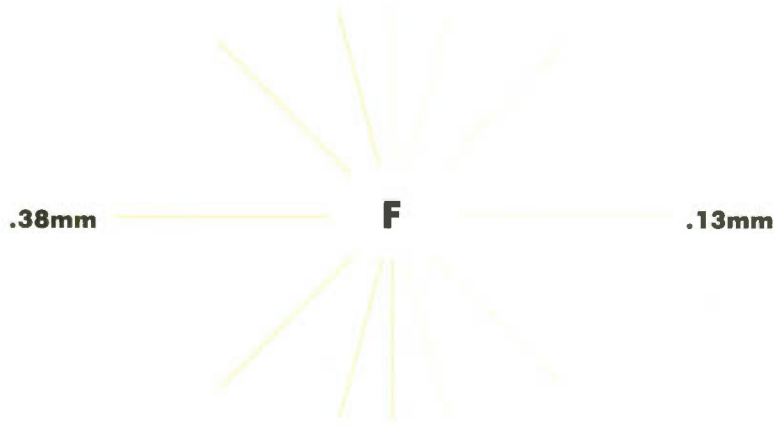

BIANGULAR SCREENS — TRAMES BIANGULÉES

M

6 pt. Century Text-Italic/Italique	.08mm	
8 pt. Triumvirate Roman/Romain	.13mm	
10 pt. Futura Roman/Romain	.18mm	
12 pt. CG Trade Condensed/Condensé	.25mm	
12 pt. Futura Roman/Romain	.38mm	

N

6 pt. Century Text-Italic/Italique	.08mm	
8 pt. Triumvirate Roman/Romain	.13mm	
10 pt. Futura Roman/Romain	.18mm	
12 pt. CG Trade Condensed/Condensé	.25mm	
12 pt. Century Text-Italic/Italique	.38mm	

O

6 pt. Century Text-Italic/Italique	.08mm	
8 pt. Triumvirate Roman/Romain	.13mm	
10 pt. Futura Roman/Romain	.18mm	
12 pt. CG Trade Condensed/Condensé	.25mm	
12 pt. Triumvirate Roman/Romain	.38mm	

P

6 pt. Century Text-Italic/Italique	.08mm	
8 pt. Triumvirate Roman/Romain	.13mm	
10 pt. Futura Roman/Romain	.18mm	
12 pt. CG Trade Condensed/Condensé	.25mm	
12 pt. Futura Roman/Romain	.38mm	

SOLID — TEINTE PLATE

6 pt. Century Text-Italic/Italique	.08mm	
8 pt. Triumvirate Roman/Romain	.13mm	
10 pt. Futura Roman/Romain	.18mm	
12 pt. CG Trade Condensed/Condensé	.25mm	
12 pt. CG Trade Condensed/Condensé	.38mm	

A

B

C

D

E

F

G

H

I

J

S

TECHNICAL INFORMATION — DONNÉES TECHNIQUES

INK - ENCRE

PANTONE® * FORMUL (A)

COLOUR No. COULEUR : 5970-126

- .2800 parts Pantone Warm Red
- .0600 parts Pantone Process Yellow
- .0200 parts Pantone Mixing Black
- .6400 parts Pantone Extender

AIM SOLID DENSITY
DENSITÉ TEINTE PLATE VISÉE : 0.47 W/H 0.46 D/S

GRAYNESS - NETTETÉ : N/A

HUE ERROR - DÉVIATION DE : N/A
TEINTE

INK EFFICIENCY
EFFICACITÉ DE L'ENCRE : N/A

DENSITOMETRY / DENSITOMÉTRIE

- CHANNEL-SÉLECTION: YELLOW/JAUNE
- FILTER TYPE DE FILTRES: STATUS T
- FACTEUR n FACTOR: 2.7

* Pantone, Inc.'s check-standard trademark for colour reproduction and colour reproduction materials.
* La marque de Pantone, Inc. de contrôle uniforme pour la reproduction en couleur et les matériaux pour la reproduction en couleur.

CIE CHROMATICITY DIAGRAM(ME) DES CHROMATICITÉS CIE

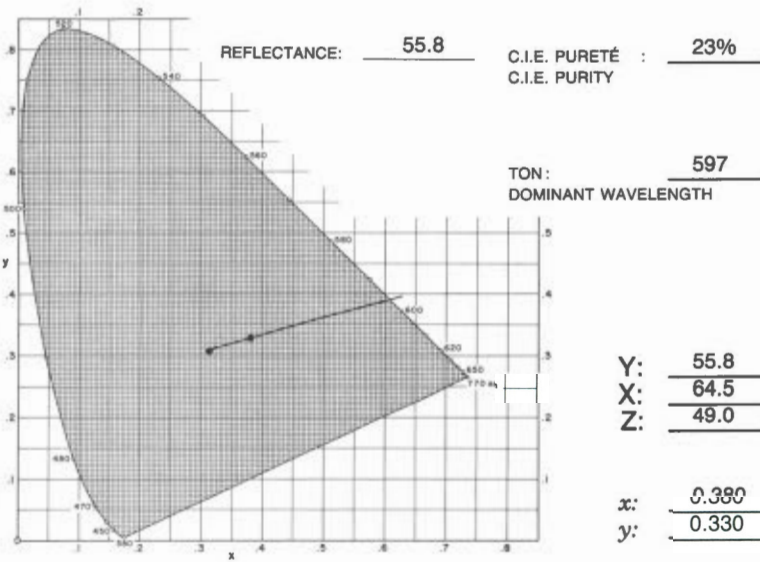

ID. PATCHES BLOCS IDEN.	% SCREEN TRAME	DENSITY DENSITÉ	% PRINT IMPRESSION
A	3	.12	5
B	6	.13	8
C	12	.15	16
D	22	.18	26
E	30	.21	36
F	40	.24	48
G	52	.29	57
H	66	.34	74
I	77	.37	85
J	87	.38	87
M	14	.17	21
N	27	.21	36
O	37	.24	46
P	51	.28	58
SOLID TEINTE PLATE	100	.41	100

PAPER - PAPIER

GRADE / CATÉGORIE: W.S. STANDARD

TYPE: UNCOATED - NON COUCHÉ

REFLECTIVITÉ / REFLECTIVITY: 77%

OPACITÉ / OPACITY: 87%

% CONTRASTE/CONTRAST: 10%

PLATE - PLAQUE

SUBT. - SOUST.

TYPE: NEGATIVE

PRESS - PRESSE

• MEIHLE

• UNIT(É) #: LOWER/INFÉRIEURE

The colour printed here was blended from, and should only be blended from PANTONE Basic Colours obtained from a PANTONE Licensed Printing Ink Manufacturer. Pantone, Inc. assumes no responsibility for the accuracy of the formulas or the colour reproduced.

La couleur ci-imprimée fut et devrait être mélangée seulement à partir des couleurs de base PANTONE obtenues d'un manufacturier d'encre autorisé. La compagnie Pantone, Inc. n'assume aucune responsabilité quant à l'exactitude du mélange ou de la couleur obtenue.

RDD - DRD
COLOURS AND SCREENS
COULEURS ET TRAMES

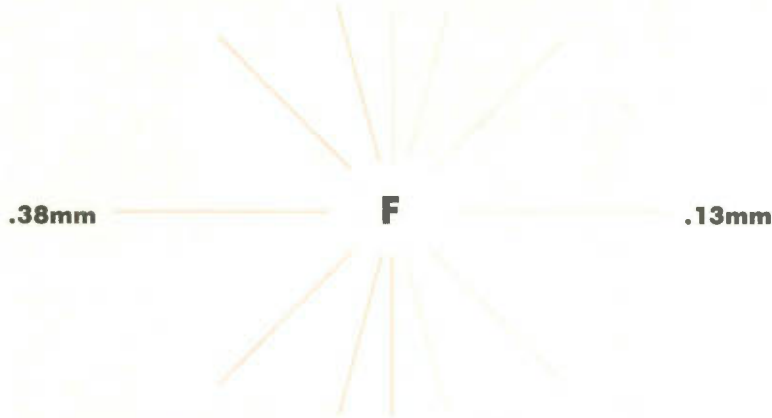

BIANGULAR SCREENS — TRAMES BIANGULÉES

M

6 pt. Futura Roman/Romain	.08mm	
8 pt. Futura Roman/Romain	.13mm	
10 pt. Futura Roman/Romain	.18mm	
12 pt. CG Trade Condensed/Condensé	.25mm	
14 pt. CG Trade Condensed/Condensé	.38mm	

N

6 pt. Futura Roman/Romain	.08mm	
8 pt. Futura Roman/Romain	.13mm	
10 pt. CG Trade Condensed/Condensé	.18mm	
12 pt. Cent. Text It./Italique	.25mm	
	.38mm	

O

6 pt. Futura Roman/Romain	.08mm	
8 pt. CG Trade Condensed/Condensé	.13mm	
10 pt. Century Text It./Italique	.18mm	
12 pt. Trium. Rom./Romain	.25mm	
	.38mm	

P

6 pt. CG Trade Condensed/Condensé	.08mm	
8 pt. Century Text It./Italique	.13mm	
10 pt. Triumvirate Roman/Romain	.18mm	
12 pt. Futura Roman/Romain	.25mm	
	.38mm	

SOLID — TEINTE PLATE

6 pt. Century Text It./Italique	.08mm	
8 pt. Triumvirate Roman/Romain	.13mm	
10 pt. Futura Roman/Romain	.18mm	
12 pt. CG Trade Condensed/Condensé	.25mm	
	.38mm	

A

B

C

D

E

F

G

H

I

J

S

TECHNICAL INFORMATION — DONNÉES TECHNIQUES

INK - ENCRE

PANTONE® * FORMUL (A/E)

COLOUR No. COULEUR : 5970-126

- .2800 parts Pantone Warm Red
- .0600 parts Pantone Process Yellow
- .0200 parts Pantone Mixing Black
- .6400 parts Pantone Extender

AIM SOLID DENSITY
DENSITÉ TEINTE PLATE VISÉE : 0.44 W/H 0.42 D/S

GRAYNESS - NETTETÉ : N/A

HUE ERROR - DÉVIATION DE : N/A
TEINTE

INK EFFICIENCY : N/A
EFFICACITÉ DE L'ENCRE

DENSITOMETRY / DENSITOMÉTRIE

- CHANNEL-SÉLECTION: YELLOW/JAUNE
- FILTER TYPE DE FILTRES: STATUS T
- FACTEUR n FACTOR: 2.7

* Pantone, Inc.'s check-standard trademark for colour reproduction and colour reproduction materials.
* La marque de Pantone, Inc. de contrôle uniforme pour la reproduction en couleur et les matériaux pour la reproduction en couleur.

CIE CHROMATICITY DIAGRAM(ME) DES CHROMATICITÉS CIE

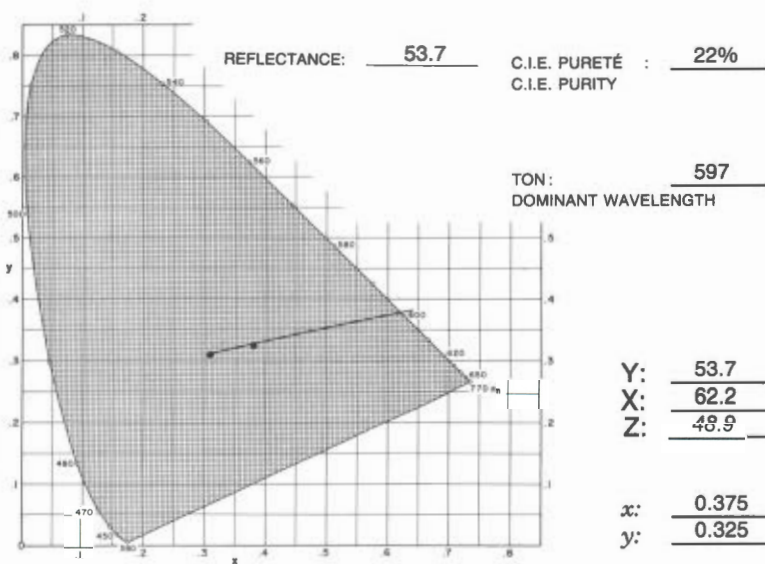

ID. PATCHES BLOCS IDEN.	% SCREEN TRAME	DENSITY DENSITÉ	% PRINT IMPRESSION
A	3	.11	5
B	6	.12	10
C	12	.14	17
D	22	.17	28
E	30	.20	38
F	40	.24	48
G	52	.27	61
H	66	.32	75
I	77	.34	82
J	87	.36	87
M	14	.16	23
N	27	.21	38
O	37	.23	48
P	51	.27	60
SOLID TEINTE PLATE	100	.40	100

PAPER - PAPIER

GRADE / CATÉGORIE: W.S. NEW BRITE

TYPE: UNCOATED - NON COUCHÉ

REFLECTIVITÉ / REFLECTIVITY: 81%

OPACITÉ / OPACITY: 85.5%

% CONTRASTE/CONTRAST: 15%

PLATE - PLAQUE

SUBT. - SOUST.

TYPE: NEGATIVE

PRESS - PRESSE

• MEIHLE

• UNIT(É) #: LOWER/INFÉRIEURE

The colour printed here was blended from, and should only be blended from PANTONE Basic Colours obtained from a PANTONE Licensed Printing Ink Manufacturer.
Pantone, Inc. assumes no responsibility for the accuracy of the formulas or the colour reproduced.

La couleur ci-imprimée fut et devrait être mélangée seulement à partir des couleurs de base PANTONE obtenues d'un fabricant d'encre autorisé.
La compagnie Pantone, Inc. n'assume aucune responsabilité quant à l'exactitude du mélange ou de la couleur obtenue.

RDD - DRD

COLOURS AND SCREENS

COULEURS ET TRAMES

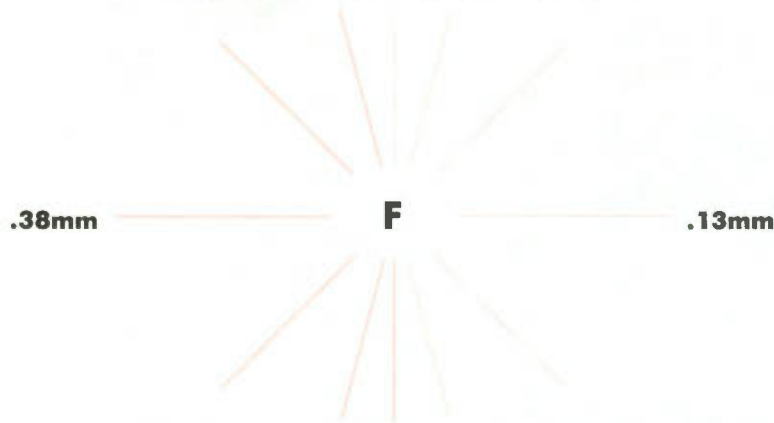

BIANGULAR SCREENS — TRAMES BIANGULÉES

M

4 pt. Century Text Italic/Italique	.08mm	
6 pt. Century Text Italic/Italique	.13mm	
8 pt. Futura Roman/Romain	.18mm	
10 pt. CG Trade Condensed/Condensé	.25mm	
12 pt. CG Trade Condensed/Condensé	.38mm	

N

4 pt. Century Text Italic/Italique	.08mm	
6 pt. Futura Roman/Romain	.13mm	
10 pt. CG Trade Condensed/Condensé	.18mm	
12 pt. Cent. Text Italic/Italique	.25mm	
	.38mm	

O

6 pt. Futura Roman/Romain	.08mm	
8 pt. CG Trade Condensed/Condensé	.13mm	
10 pt. Century Text Italic/Italique	.18mm	
12 pt. Trium. Rom./Romain	.25mm	
	.38mm	

P

6 pt. CG Trade Condensed/Condensé	.08mm	
8 pt. Century Text Italic/Italique	.13mm	
10 pt. Triumvirate Roman/Romain	.18mm	
12 pt. Futura Roman/Romain	.25mm	
	.38mm	

SOLID — TEINTE PLATE

6 pt. Century Text Italic/Italique	.08mm	
8 pt. Triumvirate Roman/Romain	.13mm	
10 pt. Futura Roman/Romain	.18mm	
12 pt. CG Trade Condensed/Condensé	.25mm	
	.38mm	

A

B

C

D

E

F

G

H

I

J

S

TECHNICAL INFORMATION — DONNÉES TECHNIQUES

INK - ENCRE

PANTONE® * FORMUL (A/E)

COLOUR No. COULEUR : 6020-122

AIM SOLID DENSITY
DENSITÉ TEINTE PLATE VISÉE : 1.00 W/H 0.96 D/S

GRAYNESS - NETTETÉ : N/A

HUE ERROR - DÉVIATION DE : N/A
TEINTE

INK EFFICIENCY : N/A
EFFICACITÉ DE L'ENCRE

DENSITOMETRY / DENSITOMÉTRIE

- CHANNEL-SÉLECTION: YELLOW/JAUNE
- FILTER TYPE DE FILTRES: STATUS T
- FACTEUR n FACTOR: 2.7

* Pantone, Inc.'s check-standard trademark for colour reproduction and colour reproduction materials.
* La marque de Pantone, Inc. de contrôle uniforme pour la reproduction en couleur et les matériaux pour la reproduction en couleur.

ID. PATCHES BLOCS IDEN.	% SCREEN TRAME	DENSITY DENSITÉ	% PRINT IMPRESSION
A	3	.14	5
B	6	.16	9
C	12	.20	17
D	22	.27	28
E	30	.35	37
F	40	.43	50
G	52	.55	60
H	66	.66	77
I	77	.74	82
J	87	.82	91
M	14	.25	22
N	27	.37	39
O	37	.43	50
P	51	.52	59
SOLID TEINTE PLATE	100	.93	100

CIE CHROMATICITY DIAGRAM(ME) DES CHROMATICITÉS CIE

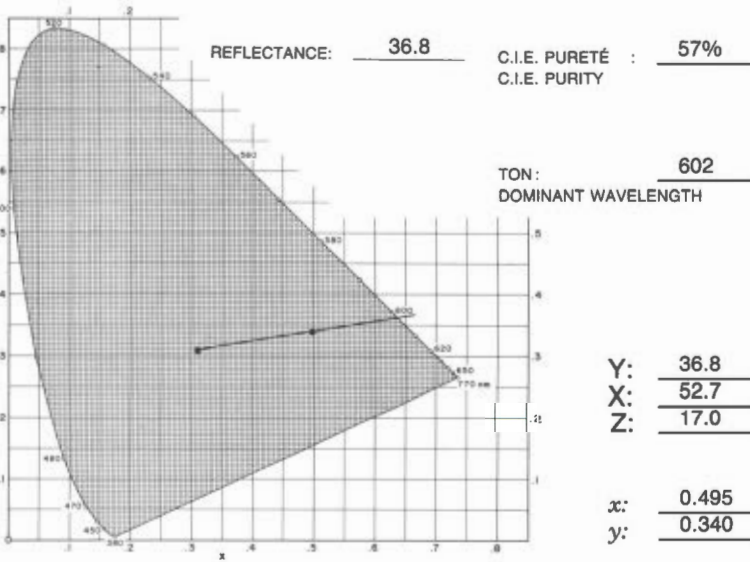

PAPER - PAPIER

GRADE / CATÉGORIE: W.S. STANDARD

TYPE: UNCOATED - NON COUCHÉ

REFLECTIVITÉ / REFLECTIVITY: 79%

OPACITÉ / OPACITY: 87%

% CONTRASTE/CONTRAST: 20%

PLATE - PLAQUE

SUBT. - SOUST.

TYPE: NEGATIVE

PRESS - PRESSE

• MEIHLE

• UNIT(É) #: LOWER/INFÉRIEURE

The colour printed here was blended from, and should only be blended from PANTONE Basic Colours obtained from a PANTONE Licensed Printing Ink Manufacturer.
Pantone, Inc. assumes no responsibility for the accuracy of the formulas or the colour reproduced.

La couleur ci-imprimée fut et devrait être mélangée seulement à partir des couleurs de base PANTONE obtenues d'un fabricant d'encre autorisé.
La compagnie Pantone, Inc. n'assume aucune responsabilité quant à l'exactitude du mélange ou de la couleur obtenue.

RDD - DRD

COLOURS AND SCREENS

COULEURS ET TRAMES

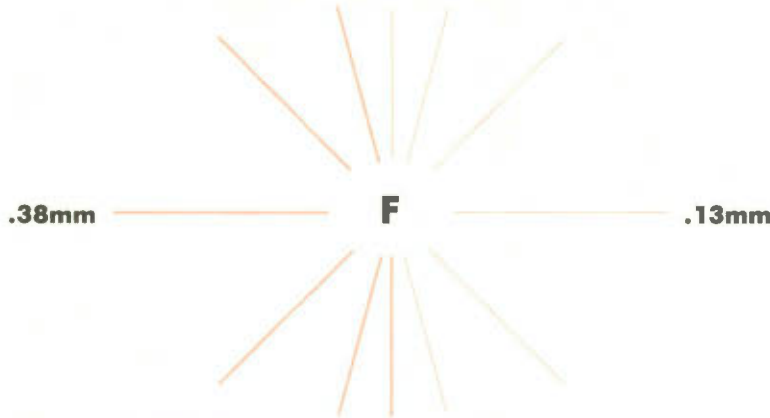

BIANGULAR SCREENS — TRAMES BIANGULÉES

M

4 pt. Triumvirate Roman/Romain
8 pt. Triumvirate Roman/Romain
10 pt. Futura Roman/Romain
12 pt. CG Trade Condensed/Condensé



N

8 pt. Triumvirate Roman/Romain
8 pt. Futura Roman/Romain
10 pt. CG Trade Condensed/Condensé
12 pt. Cent. Text It./Italique



O

8 pt. Futura Roman/Romain
8 pt. CG Trade Condensed/Condensé
10 pt. Century Text Italic/Italique
12 pt. Triumvirate Roman/Romain



P

8 pt. CG Trade Condensed/Condensé
8 pt. Century Text Italic/Italique
10 pt. Triumvirate Roman/Romain
12 pt. Futura Roman/Romain



SOLID — TEINTE PLATE

6 pt. Century Text Italic/Italique
8 pt. Triumvirate Roman/Romain
10 pt. Futura Roman/Romain
12 pt. CG Trade Condensed/Condensé



A

B

C

D

E

F

G

H

I

J

S

TECHNICAL INFORMATION — DONNÉES TECHNIQUES

INK - ENCRE

PANTONE® * FORMUL (A/E)

COLOUR No. COULEUR : 6020-122

AIM SOLID DENSITY
DENSITÉ TEINTE PLATE VISÉE : 0.95 W/H 0.94 D/S

GRAYNESS - NETTETÉ : N/A

HUE ERROR - DÉVIATION DE : N/A
TEINTE

INK EFFICIENCY : N/A
EFFICACITÉ DE L'ENCRE

DENSITOMETRY / DENSITOMÉTRIE

• CHANNEL-SÉLECTION: YELLOW/JAUNE

• FILTER TYPE DE FILTRES: STATUS T

• FACTEUR n FACTOR: 2.7

* Pantone, Inc.'s check-standard trademark for colour reproduction and colour reproduction materials.

* La marque de Pantone, Inc. de contrôle uniforme pour la reproduction en couleur et les matériaux pour la reproduction en couleur.

CIE CHROMATICITY DIAGRAM(ME) DES CHROMATICITÉS CIE

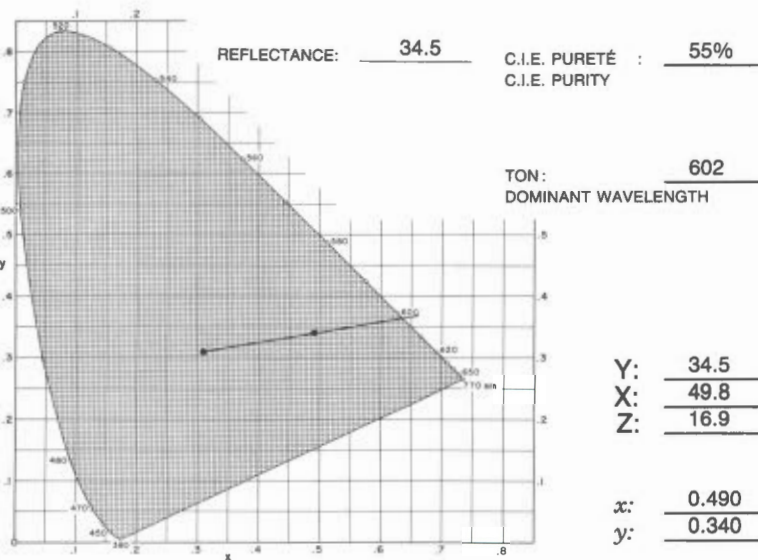

ID. PATCHES BLOCS IDEN.	% SCREEN FRAME	DENSITY DENSITÉ	% PRINT IMPRESSION
A	3	.13	6
B	6	.16	11
C	12	.20	19
D	22	.27	29
E	30	.34	40
F	40	.43	52
G	52	.53	64
H	66	.65	78
I	77	.74	88
J	87	.79	93
M	14	.24	23
N	27	.36	41
O	37	.42	51
P	51	.51	61
SOLID TEINTE PLATE	100	.86	100

PAPER - PAPIER

GRADE / CATÉGORIE: W.S. NEW BRITE

TYPE: UNCOATED - NON COUCHÉ

REFLECTIVITÉ / REFLECTIVITY: 79%

OPACITÉ / OPACITY: 85.5%

% CONTRASTE/CONTRAST: 14%

PLATE - PLAQUE

SUBT. - SOUST.

TYPE: NEGATIVE

PRESS - PRESSE

• MEIHLE

• UNIT(É) #: LOWER/INFÉRIEURE

The colour printed here was blended from, and should only be blended from PANTONE Basic Colours obtained from a PANTONE Licensed Printing Ink Manufacturer. Pantone, Inc. assumes no responsibility for the accuracy of the formulas or the colour reproduced.

La couleur ci-imprimée fut et devrait être mélangée seulement à partir des couleurs de base PANTONE obtenues d'un manufacturier d'encre autorisé. La compagnie Pantone, Inc. n'assume aucune responsabilité quant à l'exactitude du mélange ou de la couleur obtenue.

RDD - DRD

COLOURS AND SCREENS COULEURS ET TRAMES

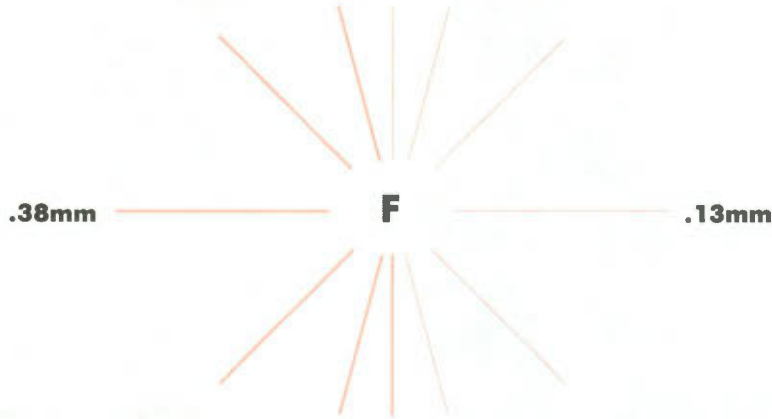

BIANGULAR SCREENS — TRAMES BIANGULÉES

M

6 pt. *Triumvirate Roman/Romain*
8 pt. *Triumvirate Roman/Romain*
10 pt. *Futura Roman/Romain*
12 pt. *CG Trade Condensed/Condensé*



N

6 pt. *Triumvirate Roman/Romain*
8 pt. *Futura Roman/Romain*
10 pt. *CG Trade Condensed/Condensé*
12 pt. *Cent. Text It./Italique*



O

6 pt. *Futura Roman/Romain*
8 pt. *CG Trade Condensed/Condensé*
10 pt. *Century Text Italic/Italique*
12 pt. *Trium. Rom./Romain*



P

6 pt. *CG Trade Condensed/Condensé*
8 pt. *Century Text Italic/Italique*
10 pt. *Triumvirate Roman/Romain*
12 pt. *Futura Roman/Romain*



SOLID — TEINTE PLATE

6 pt. *Century Text Italic/Italique*
8 pt. *Triumvirate Roman/Romain*
10 pt. *Futura Roman/Romain*
12 pt. *CG Trade Condensed/Condensé*



A

B

C

D

E

F

G

H

I

J

S

TECHNICAL INFORMATION — DONNÉES TECHNIQUES

INK - ENCRE

PANTONE® * FORMUL (A/E)

COLOUR No. COULEUR : 6060-123

AIM SOLID DENSITY
DENSITÉ TEINTE PLATE VISÉE : 1.03 W/H 0.93 D/S

GRAYNESS - NETTETÉ : N/A

HUE ERROR - DÉVIATION DE : N/A
TEINTE

INK EFFICIENCY : N/A
EFFICACITÉ DE L'ENCRE

DENSITOMETRY / DENSITOMÉTRIE

• CHANNEL-SÉLECTION: MAGENTA

• FILTER TYPE DE FILTRES: STATUS T

• FACTEUR n FACTOR: 2.7

* Pantone, Inc.'s check-standard trademark for colour reproduction and colour reproduction materials.
* La marque de Pantone, Inc. de contrôle uniforme pour la reproduction en couleur et les matériaux pour la reproduction en couleur.

CIE CHROMATICITY DIAGRAM(ME) DES CHROMATICITÉS CIE

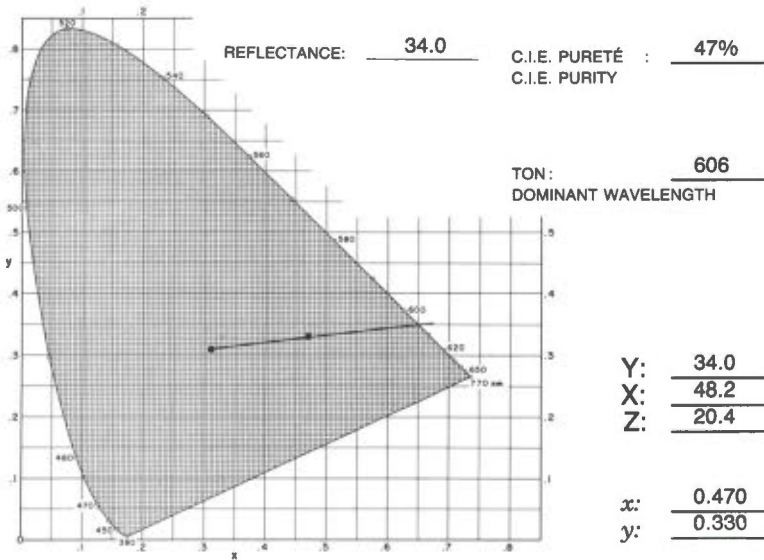

ID. PATCHES BLOCS IDEN.	% SCREEN TRAME	DENSITY DENSITÉ	% PRINT IMPRESSION
A	3	.10	7
B	6	.12	9
C	12	.17	19
D	22	.26	29
E	30	.32	41
F	40	.41	52
G	52	.51	64
H	66	.62	76
I	77	.69	85
J	87	.77	93
M	14	.22	25
N	27	.33	42
O	37	.40	53
P	51	.50	63
SOLID TEINTE PLATE	100	.85	100

PAPER - PAPIER

GRADE / CATÉGORIE: W.S. STANDARD

TYPE: UNCOATED - NON COUCHÉ

REFLECTIVITÉ / REFLECTIVITY: 85%

OPACITÉ / OPACITY: 87%

% CONTRASTE/CONTRAST: 19%

PLATE - PLAQUE

SUBT. - SOUST.

TYPE: NEGATIVE

PRESS - PRESSE

• MEIHLE

• UNIT(É) #: LOWER/INFÉRIEURE

The colour printed here was blended from, and should only be blended from PANTONE Basic Colours obtained from a PANTONE Licensed Printing Ink Manufacturer.
Pantone, Inc. assumes no responsibility for the accuracy of the formulas or the colour reproduced.

La couleur ci-imprimée fut et devrait être mélangée seulement à partir des couleurs de base PANTONE obtenues d'un fabricant d'encre autorisé.
La compagnie Pantone, Inc. n'assume aucune responsabilité quant à l'exactitude du mélange ou de la couleur obtenue.

RDD - DRD

COLOURS AND SCREENS

COULEURS ET TRAMES

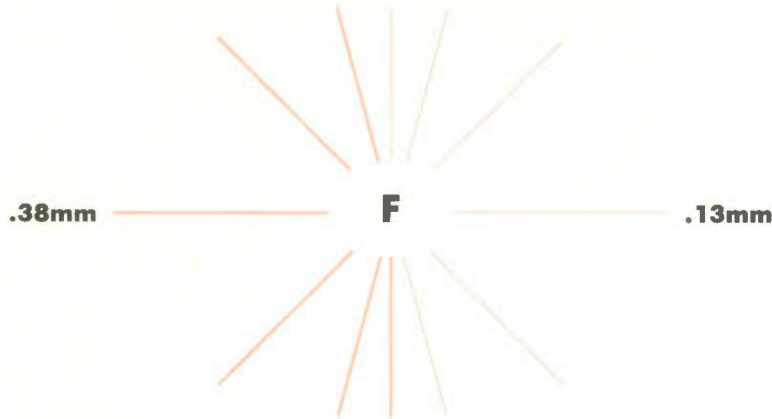

BIANGULAR SCREENS — TRAMES BIANGULÉES

M

6 pt. *Century Text Italic/Italique*
8 pt. *Triumvirate Roman/Romain*
10 pt. *Futura Roman/Romain*
12 pt. *CG Trade Condensed/Condensé*



N

6 pt. *Triumvirate Roman/Romain*
8 pt. *Futura Roman/Romain*
10 pt. *CG Trade Condensed/Condensé*
12 pt. *Cent. Text It./Italique*



O

6 pt. *Futura Roman/Romain*
8 pt. *CG Trade Condensed/Condensé*
10 pt. *Century Text Italic/Italique*
12 pt. *Trium. Rom./Romain*



P

6 pt. *CG Trade Condensed/Condensé*
8 pt. *Century Text Italic/Italique*
10 pt. *Triumvirate Roman/Romain*
12 pt. *Futura Roman/Romain*



SOLID — TEINTE PLATE

6 pt. *Century Text Italic/Italique*
8 pt. *Triumvirate Roman/Romain*
10 pt. *Futura Roman/Romain*
12 pt. *CG Trade Condensed/Condensé*



A

B

C

D

E

F

G

H

I

J

S

TECHNICAL INFORMATION — DONNÉES TECHNIQUES

INK - ENCRE

PANTONE® * FORMUL (A/E)

COLOUR No. COULEUR : 6060-123

AIM SOLID DENSITY
DENSITÉ TEINTE PLATE VISÉE : 0.99 W/H 0.92 D/S

GRAYNESS - NETTETÉ : N/A

HUE ERROR - DÉVIATION DE : N/A
TEINTE

INK EFFICIENCY : N/A
EFFICACITÉ DE L'ENCRE

DENSITOMETRY / DENSITOMÉTRIE

- CHANNEL-SÉLECTION: MAGENTA
- FILTER TYPE DE FILTRES: STATUS T
- FACTEUR n FACTOR: 2.7

* Pantone, Inc.'s check-standard trademark for colour reproduction and colour reproduction materials.

* La marque de Pantone, Inc. de contrôle uniforme pour la reproduction en couleur et les matériaux pour la reproduction en couleur.

CIE CHROMATICITY DIAGRAM(ME) DES CHROMATICITÉS CIE

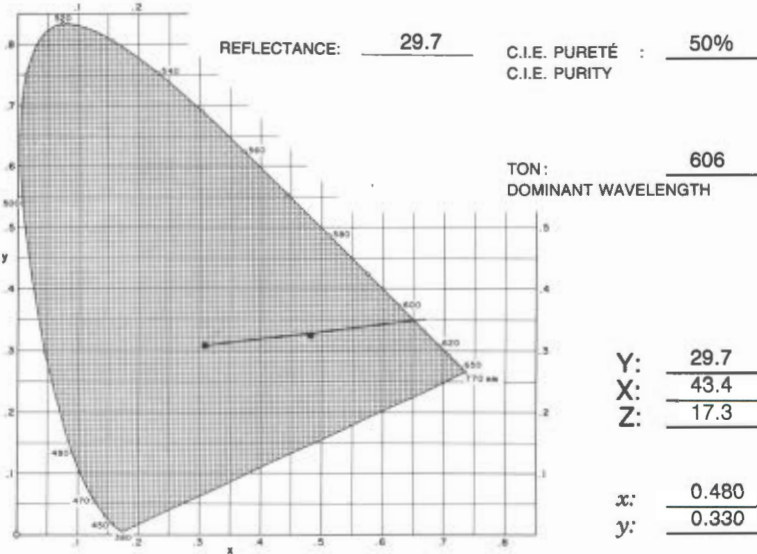

PAPER - PAPIER

GRADE / CATÉGORIE: W.S. NEW BRITE

TYPE: UNCOATED - NON COUCHÉ

REFLECTIVITÉ / REFLECTIVITY: 85%

OPACITÉ / OPACITY: 85.5%

% CONTRASTE/CONTRAST: 14%

PLATE - PLAQUE

TYPE: SUBT. - SOUST.

TYPE: NEGATIVE

PRESS - PRESSE

• MEIHLE

• UNIT(É) #: LOWER/INFÉRIEURE

ID. PATCHES BLOCS IDEN.	% SCREEN TRAME	DENSITY DENSITÉ	% PRINT IMPRESSION
A	3	.11	7
B	6	.13	12
C	12	.19	20
D	22	.26	33
E	30	.34	44
F	40	.42	56
G	52	.53	70
H	66	.63	82
I	77	.72	92
J	87	.77	98
M	14	.23	29
N	27	.36	46
O	37	.42	58
P	51	.51	66
SOLID TEINTE PLATE	100	.84	100

The colour printed here was blended from, and should only be blended from PANTONE Basic Colours obtained from a PANTONE Licensed Printing Ink Manufacturer. Pantone, Inc. assumes no responsibility for the accuracy of the formulas or the colour reproduced.

La couleur ci- imprimée fut et devrait être mélangée seulement à partir des couleurs de base PANTONE obtenues d'un fabricant d'encre autorisé. La compagnie Pantone, Inc. n'assume aucune responsabilité quant à l'exactitude du mélange ou de la couleur obtenue.

TECHNICAL INFORMATION — DONNÉES TECHNIQUES

INK - ENCRE

PANTONE® * FORMUL (A)
(E)

COLOUR No. COULEUR : 6110-6120

___ .3410 parts Pantone Process Yellow

___ .5680 parts Pantone Rubine Red

___ .0910 parts Pantone Mixing Black

AIM SOLID DENSITY
DENSITÉ TEINTE PLATE VISÉE : 1.06 W/H 0.96 D/S

GRAYNESS - NETTETÉ : N/A

HUE ERROR - DÉVIATION DE : N/A
TEINTE

INK EFFICIENCY : N/A
EFFICACITÉ DE L'ENCRE

DENSITOMETRY / DENSITOMÉTRIE

• CHANNEL-SÉLECTION: MAGENTA

• FILTER TYPE DE FILTRES: STATUS T

• FACTEUR n FACTOR: 2.7

* Pantone, Inc.'s check-standard trademark for colour reproduction and colour reproduction materials.

* La marque de Pantone, Inc. de contrôle uniforme pour la reproduction en couleur et les matériaux pour la reproduction en couleur.

CIE CHROMATICITY DIAGRAM (ME) DES CHROMATICITÉS CIE

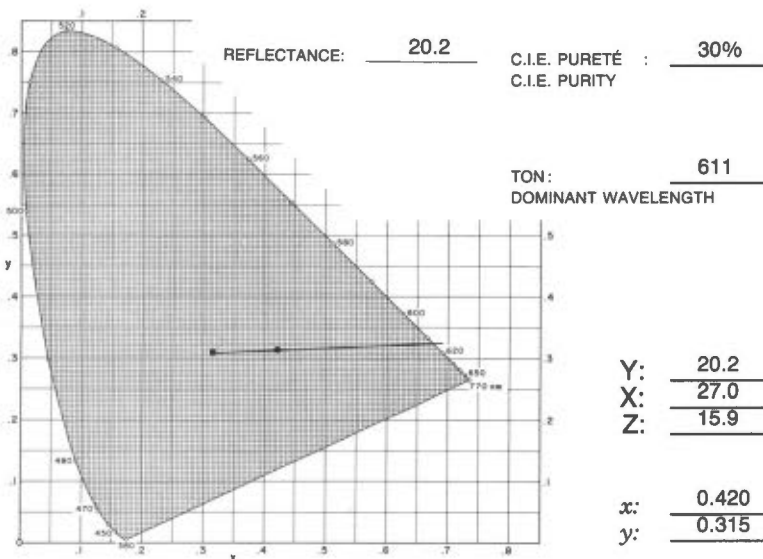

ID. PATCHES BLOCS IDEN.	% SCREEN FRAME	DENSITY DENSITÉ	% PRINT IMPRESSION
A	3	.11	7
B	6	.14	11
C	12	.20	21
D	22	.27	32
E	30	.36	41
F	40	.47	57
G	52	.63	78
H	66	.80	89
I	77	.85	95
J	87	.90	97
M	14	.26	27
N	27	.38	46
O	37	.47	58
P	51	.61	69
SOLID TEINTE PLATE	100	.92	100

PAPER - PAPIER

GRADE / CATÉGORIE: W.S. STANDARD

TYPE: UNCOATED - NON COUCHÉ

REFLECTIVITÉ / REFLECTIVITY: 83%

OPACITÉ / OPACITY: 87%

% CONTRASTE/CONTRAST: 8%

PLATE - PLAQUE

SUBT. - SOUST.

TYPE: NEGATIVE

PRESS - PRESSE

• MEIHLE

• UNIT(É) #: LOWER/INFÉRIEURE

The colour printed here was blended from, and should only be blended from PANTONE Basic Colours obtained from a PANTONE Licensed Printing Ink Manufacturer. Pantone, Inc. assumes no responsibility for the accuracy of the formulas or the colour reproduced.

La couleur ci-imprimée fut et devrait être mélangée seulement à partir des couleurs de base PANTONE obtenues d'un fabricant d'encre autorisé. La compagnie Pantone, Inc. n'assume aucune responsabilité quant à l'exactitude du mélange ou de la couleur obtenue.

0
3
3
m
m
m
m
m

RDD - DRD

COLOURS AND SCREENS

COULEURS ET TRAMES

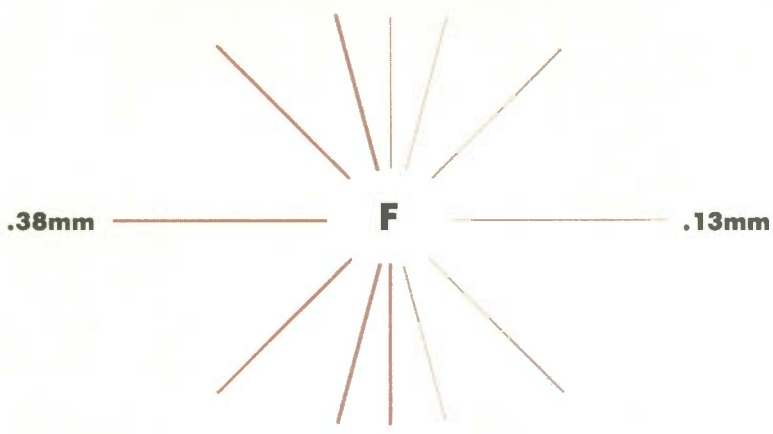

BIANGULAR SCREENS — TRAMES BIANGULÉES

M

4 pt. Century Text Italic/Italique	.08mm		
8 pt. Triumvirate Roman/Romain	.13mm		
10 pt. Futura Roman/Romain	.18mm		
12 pt. CG Trade Condensed/Condensé	.25mm		
	.38mm		

N

6 pt. Triumvirate Roman/Romain	.08mm		
8 pt. Futura Roman/Romain	.13mm		
10 pt. CG Trade Condensed/Condensé	.18mm		
12 pt. Cent. Text It./Italique	.25mm		
	.38mm		

O

6 pt. Futura Roman/Romain	.08mm		
8 pt. CG Trade Condensed/Condensé	.13mm		
10 pt. Century Text Italic/Italique	.18mm		
12 pt. Trium. Rom./Romain	.25mm		
	.38mm		

P

6 pt. CG Trade Condensed/Condensé	.08mm		
8 pt. Century Text Italic/Italique	.13mm		
10 pt. Triumvirate Roman/Romain	.18mm		
12 pt. Futura Roman/Romain	.25mm		
	.38mm		

SOLID — TEINTE PLATE

6 pt. Century Text Italic/Italique	.08mm		
8 pt. Triumvirate Roman/Romain	.13mm		
10 pt. Futura Roman/Romain	.18mm		
12 pt. CG Trade Condensed/Condensé	.25mm		
	.38mm		

A
B
C
D
E
F
G
H
I
J
S

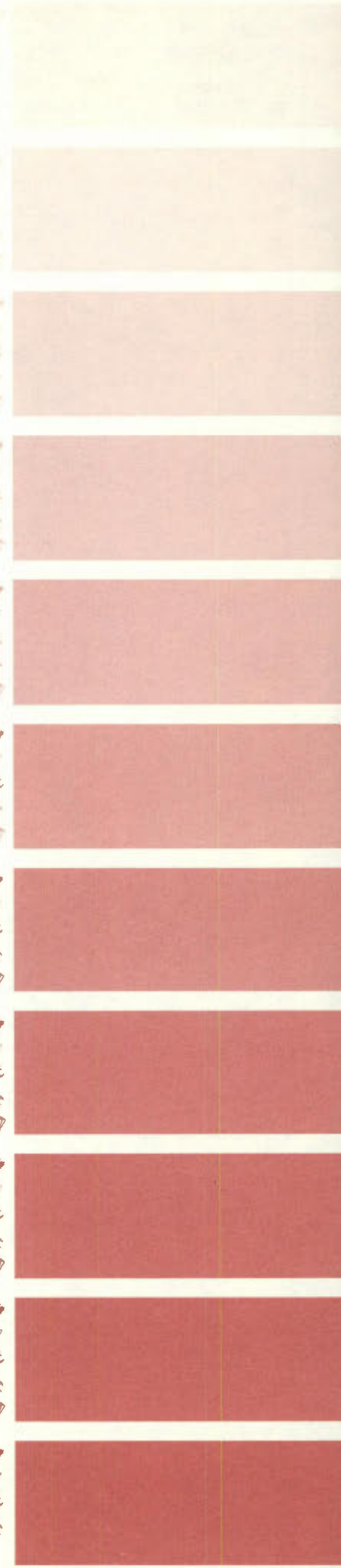

0 0 0 0
0 0 0 0
3 5 7 0 5

TECHNICAL INFORMATION — DONNÉES TECHNIQUES

INK - ENCRE

PANTONE® * FORMUL (A/E)

COLOUR No. COULEUR : 6110-6120

- .3410 parts Pantone Process Yellow
- .5680 parts Pantone Rubine Red
- .0910 parts Pantone Mixing Black

AIM SOLID DENSITY
DENSITÉ TEINTE PLATE VISÉE : 1.00 W/H 0.91 D/S

GRAYNESS - NETTETÉ : N/A

HUE ERROR - DÉVIATION DE : N/A
TEINTE

INK EFFICIENCY : N/A
EFFICACITÉ DE L'ENCRE

DENSITOMETRY / DENSITOMÉTRIE

- CHANNEL-SÉLECTION: MAGENTA
- FILTER TYPE DE FILTRES: STATUS T
- FACTEUR n FACTOR: 2.7

* Pantone, Inc.'s check-standard trademark for colour reproduction and colour reproduction materials.

* La marque de Pantone, Inc. de contrôle uniforme pour la reproduction en couleur et les matériaux pour la reproduction en couleur.

CIE CHROMATICITY DIAGRAM(ME) DES CHROMATICITÉS CIE

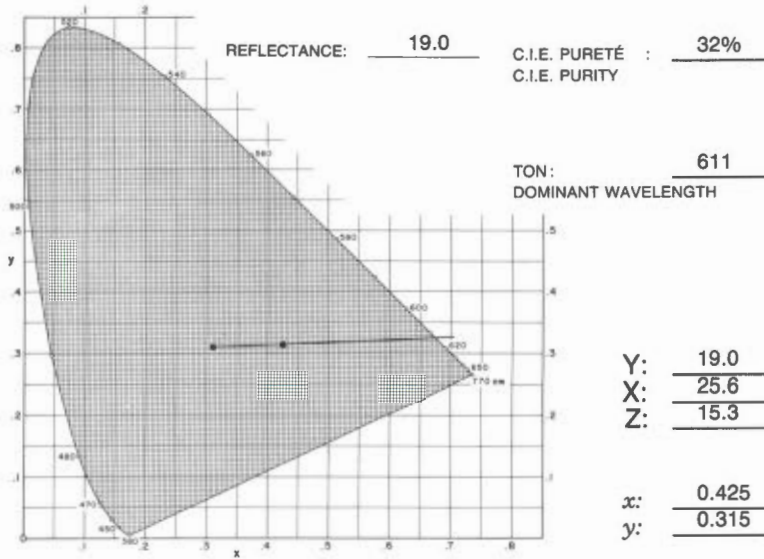

PAPER - PAPIER

GRADE / CATÉGORIE: W.S. NEW BRITE

TYPE: UNCOATED - NON COUCHÉ

REFLECTIVITÉ / REFLECTIVITY: 87%

OPACITÉ / OPACITY: 85.5%

% CONTRASTE/CONTRAST: 9%

PLATE - PLAQUE

TYPE: SUBT. - SOUST.

TYPE: NEGATIVE

PRESS - PRESSE

• MEIHLE

• UNIT(É) #: LOWER/INFÉRIEURE

ID. PATCHES BLOCS IDEN.	% SCREEN TRAME	DENSITY DENSITÉ	% PRINT IMPRESSION
A	3	.11	8
B	6	.14	13
C	12	.20	21
D	22	.28	30
E	30	.37	43
F	40	.49	61
G	52	.66	75
H	66	.78	90
I	77	.85	96
J	87	.90	97
M	14	.26	29
N	27	.40	50
O	37	.51	59
P	51	.61	73
SOLID TEINTE PLATE	100	.93	100

The colour printed here was blended from, and should only be blended from PANTONE Basic Colours obtained from a PANTONE Licensed Printing Ink Manufacturer. Pantone, Inc. assumes no responsibility for the accuracy of the formulas or the colour reproduced.

La couleur ci-imprimée fut et devrait être mélangée seulement à partir des couleurs de base PANTONE obtenues d'un fabricant d'encre autorisé. La compagnie Pantone, Inc. n'assume aucune responsabilité quant à l'exactitude du mélange ou de la couleur obtenue.

SURVEYS AND MAPPING BRANCH
DIRECTION DES LEVÉS ET DE LA CARTOGRAPHIE

AVRIL 1987
APRIL

RDD - DRD

COLOURS AND SCREENS

COULEURS ET TRAMES

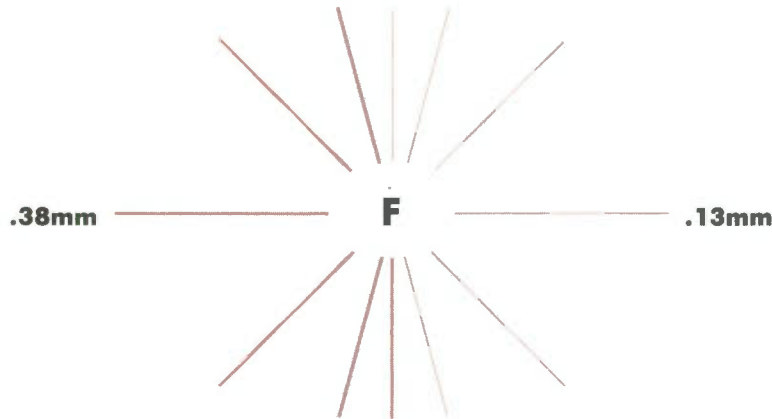

BIANGULAR SCREENS — TRAMES BIANGULÉES

M

6 pt. *Century Text Italic/Italique*
8 pt. *Triumvirate Roman/Romain*
10 pt. *Futura Roman/Romain*
12 pt. *CG Trade Condensed/Condensé*



N

6 pt. *Triumvirate Roman/Romain*
8 pt. *Futura Roman/Romain*
10 pt. *CG Trade Condensed/Condensé*
12 pt. *Cent. Text It./Italique*



O

6 pt. *Futura Roman/Romain*
8 pt. *CG Trade Condensed/Condensé*
10 pt. *Century Text Italic/Italique*
12 pt. *Trium. Rom./Romain*



P

6 pt. *CG Trade Condensed/Condensé*
8 pt. *Century Text Italic/Italique*
10 pt. *Triumvirate Roman/Romain*
12 pt. *Futura Roman/Romain*



SOLID — TEINTE PLATE

6 pt. *Century Text Italic/Italique*
8 pt. *Triumvirate Roman/Romain*
10 pt. *Futura Roman/Romain*
12 pt. *CG Trade Condensed/Condensé*

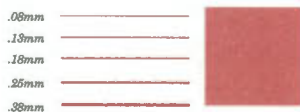

A

B

C

D

E

F

G

H

I

J

S

TECHNICAL INFORMATION — DONNÉES TECHNIQUES

INK - ENCRE

PANTONE® * FORMUL (A/E)

COLOUR No. COULEUR : 6290-121

- .800 parts Pantone Warm Red
- .200 parts Pantone Rubine Red
-
-

AIM SOLID DENSITY
DENSITÉ TEINTE PLATE VISÉE : 1.13 W/H 1.05 D/S

GRAYNESS - NETTETÉ : N/A

HUE ERROR - DÉVIATION DE : N/A
TEINTE

INK EFFICIENCY : N/A
EFFICACITÉ DE L'ENCRE

DENSITOMETRY / DENSITOMÉTRIE

- CHANNEL-SÉLECTION: MAGENTA
- FILTER TYPE DE FILTRES: STATUS "T"
- FACTEUR n FACTOR: 2.7

* Pantone, Inc.'s check-standard trademark for colour reproduction and colour reproduction materials.
* La marque de Pantone, Inc. de contrôle uniforme pour la reproduction en couleur et les matériaux pour la reproduction en couleur.

CIE CHROMATICITY DIAGRAM(ME) DES CHROMATICITÉS CIE

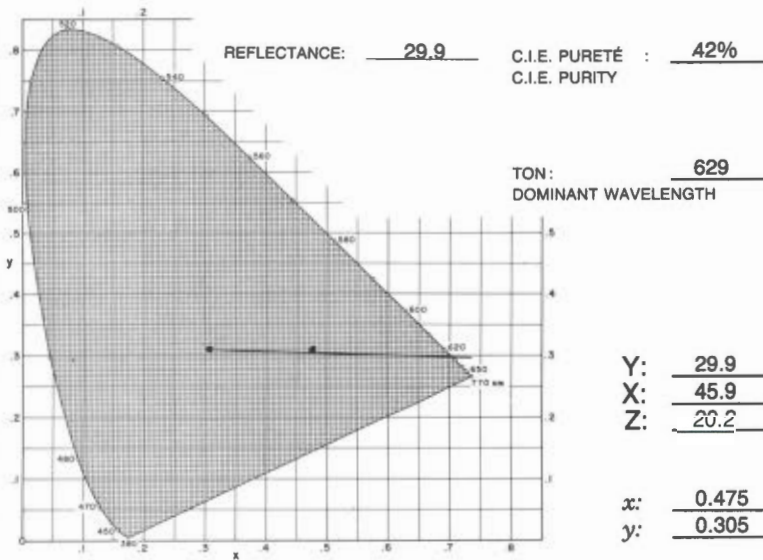

ID. PATCHES BLOCS IDEN.	% SCREEN TRAME	DENSITY DENSITÉ	% PRINT IMPRESSION
A	3	.11	8
B	6	.14	12
C	12	.20	20
D	22	.28	31
E	30	.37	42
F	40	.46	53
G	52	.61	69
H	66	.76	83
I	77	.85	93
J	87	.90	99
M	14	.25	28
N	27	.39	44
O	37	.47	54
P	51	.57	65
SOLID TEINTE PLATE	100	.98	100

PAPER - PAPIER

GRADE / CATÉGORIE: W.S. STANDARD

TYPE: UNCOATED - NON COUCHÉ

REFLECTIVITÉ / REFLECTIVITY: 85%

OPACITÉ / OPACITY: 87%

% CONTRASTE/CONTRAST: 13%

PLATE - PLAQUE

SUBT. - SOUST.

TYPE: NEGATIVE

PRESS - PRESSE

• MEIHLE

• UNIT(É) #: LOWER/INFÉRIEURE

The colour printed here was blended from, and should only be blended from PANTONE Basic Colours obtained from a PANTONE Licensed Printing Ink Manufacturer.
Pantone, Inc. assumes no responsibility for the accuracy of the formulas or the colour reproduced.

La couleur ci-imprimée fut et devrait être mélangée seulement à partir des couleurs de base PANTONE obtenues d'un manufacturier d'encre autorisé.
La compagnie Pantone, Inc. n'assume aucune responsabilité quant à l'exactitude du mélange ou de la couleur obtenue.

RDD - DRD

COLOURS AND SCREENS

COULEURS ET TRAMES

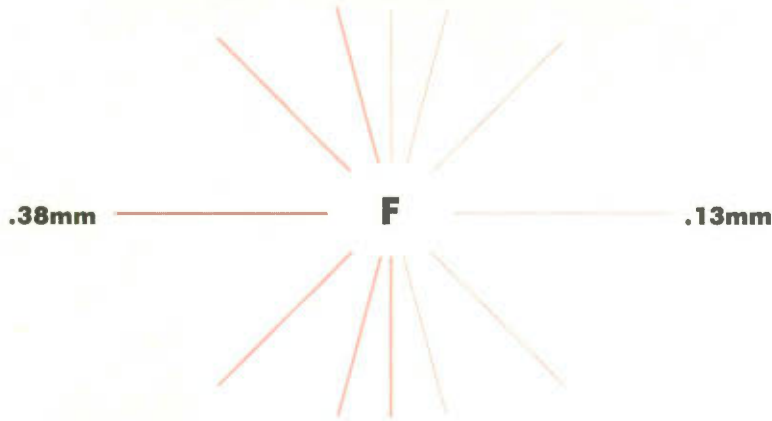

BIANGULAR SCREENS — TRAMES BIANGULÉES

M

4 pt. Century Roman/Romain
8 pt. Triumvirate Roman/Romain
10 pt. Futura Roman/Romain
12 pt. CG Trade Condensed/Condensé



N

6 pt. Triumvirate Roman/Romain
8 pt. Futura Roman/Romain
10 pt. CG Trade Condensed/Condensé
12 pt. Cent. Text It./Italique



O

6 pt. Futura Roman/Romain
8 pt. CG Trade Condensed/Condensé
10 pt. Century Text Italic/Italique
12 pt. Trium. Rom./Romain



P

6 pt. CG Trade Condensed/Condensé
8 pt. Century Text Italic/Italique
10 pt. Triumvirate Roman/Romain
12 pt. Futura Roman/Romain



SOLID — TEINTE PLATE

6 pt. Century Text Italic/Italique
8 pt. Triumvirate Roman/Romain
10 pt. Futura Roman/Romain
12 pt. CG Trade Condensed/Condensé



A

B

C

D

E

F

G

H

I

J

S

RDD - DRD

COLOURS AND SCREENS

COULEURS ET TRAMES

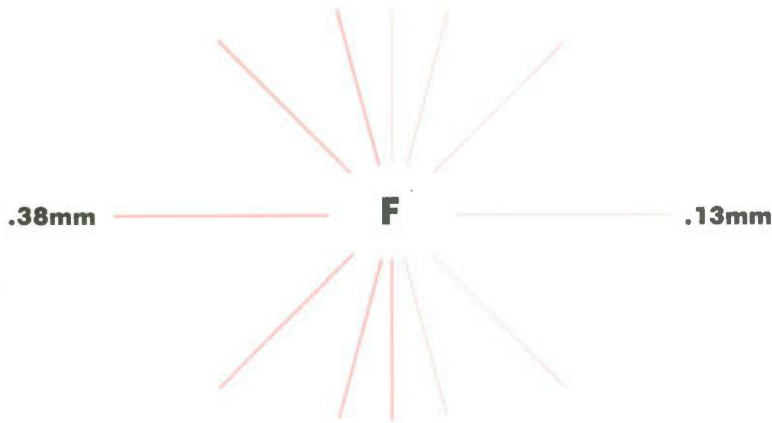

BIANGULAR SCREENS — TRAMES BIANGULÉES

M

6 pt. Triumvirate Roman/Romain
8 pt. Triumvirate Roman/Romain
10 pt. Futura Roman/Romain
12 pt. CG Trade Condensed/Condensé



N

6 pt. Triumvirate Roman/Romain
8 pt. Futura Roman/Romain
10 pt. CG Trade Condensed/Condensé
12 pt. Cent. Text It./Italique



O

6 pt. Futura Roman/Romain
8 pt. CG Trade Condensed/Condensé
10 pt. Century Text Italic/Italique
12 pt. Trium. Rom./Romain



P

6 pt. CG Trade Condensed/Condensé
8 pt. Century Text Italic/Italique
10 pt. Triumvirate Roman/Romain
12 pt. Futura Roman/Romain



SOLID — TEINTE PLATE

6 pt. Century Text Italic/Italique
8 pt. Triumvirate Roman/Romain
10 pt. Futura Roman/Romain
12 pt. CG Trade Condensed/Condensé



A

B

C

D

E

F

G

H

I

J

S

0 0 0 0
8 5 7 0 6

TECHNICAL INFORMATION — DONNÉES TECHNIQUES

INK - ENCRE

PANTONE® * FORMUL (A)
(E)

COLOUR No. COULEUR : 6290-121

- .800 parts Pantone Warm Red
- .200 parts Pantone Rubine Red
-
-

AIM SOLID DENSITY
DENSITÉ TEINTE PLATE VISÉE : 1.13 W/H 1.05 D/S

GRAYNESS - NETTETÉ : N/A

HUE ERROR - DÉVIATION DE : N/A
TEINTE

INK EFFICIENCY
EFFICACITÉ DE L'ENCRE : N/A

DENSITOMETRY / DENSITOMÉTRIE

- CHANNEL-SÉLECTION: MAGENTA
- FILTER TYPE DE FILTRES: STATUS "T"
- FACTEUR n FACTOR: 2.7

* Pantone, Inc.'s check-standard trademark for colour reproduction and colour reproduction materials.
* La marque de Pantone, Inc. de contrôle uniforme pour la reproduction en couleur et les matériaux pour la reproduction en couleur.

CIE CHROMATICITY DIAGRAM(ME) DES CHROMATICITÉS CIE

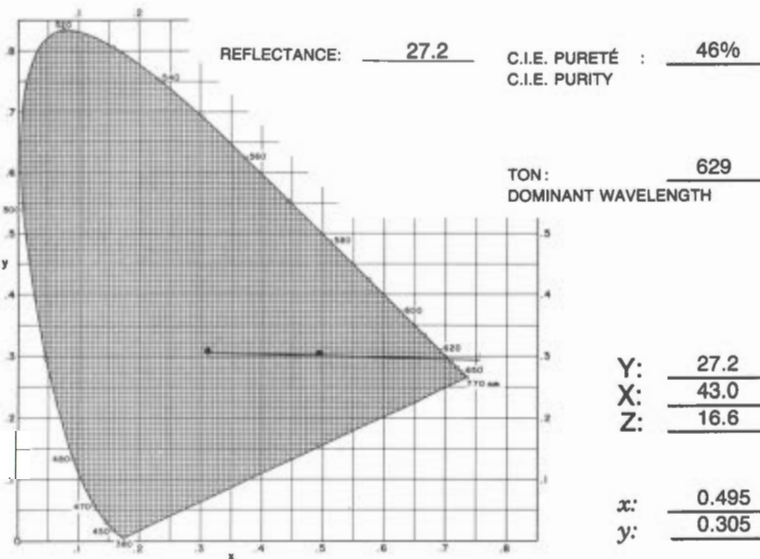

ID. PATCHES BLOCS IDEN.	% SCREEN TRAME	DENSITY DENSITÉ	% PRINT IMPRESSION
A	3	.09	5
B	6	.12	8
C	12	.16	16
D	22	.22	26
E	30	.31	35
F	40	.41	47
G	52	.54	63
H	66	.67	77
I	77	.79	87
J	87	.86	93
M	14	.21	23
N	27	.32	37
O	37	.40	46
P	51	.51	58
SOLID TEINTE PLATE	100	.98	100

PAPER - PAPIER

GRADE / CATÉGORIE: CHART

TYPE: UNCOATED - NON COUCHÉ

REFLECTIVITÉ / REFLECTIVITY: 87%

OPACITÉ / OPACITY: 96.5%

% CONTRASTE/CONTRAST: 19%

PLATE - PLAQUE

SUBT. - SOUST.

TYPE: NEGATIVE

PRESS - PRESSE

• MEIHLE

• UNIT(É) #: LOWER/INFÉRIEURE

The colour printed here was blended from, and should only be blended from PANTONE Basic Colours obtained from a PANTONE Licensed Printing Ink Manufacturer. Pantone, Inc. assumes no responsibility for the accuracy of the formulas or the colour reproduced.

La couleur ci-imprimée fut et devrait être mélangée seulement à partir des couleurs de base PANTONE obtenues d'un fabricant d'encre autorisé. La compagnie Pantone, Inc. n'assume aucune responsabilité quant à l'exactitude du mélange ou de la couleur obtenue.

RDD - DRD

COLOURS AND SCREENS

COULEURS ET TRAMES

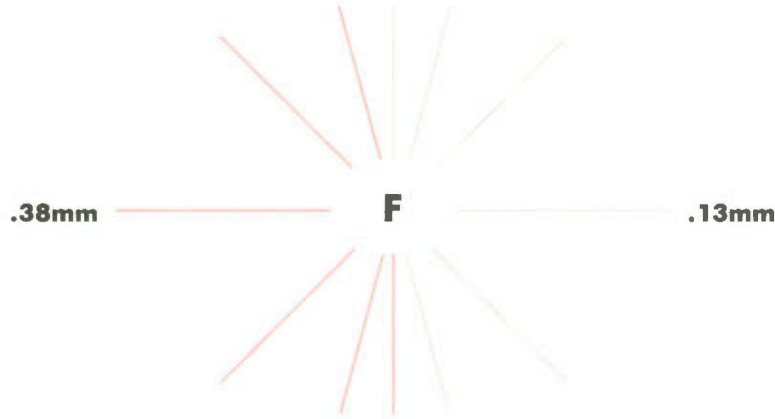

BIANGULAR SCREENS — TRAMES BIANGULÉES

M

6 pt. *Century Text Italic/Italique* .08mm
 8 pt. *Futura Roman/Romain* .13mm
 10 pt. *CG Trade Condensed/Condensé* .18mm
 12 pt. *CG Trade Condensed/Condensé* .25mm
 .38mm

N

6 pt. *Triumvirate Roman/Romain* .08mm
 8 pt. *Futura Roman/Romain* .13mm
 10 pt. *CG Trade Condensed/Condensé* .18mm
 12 pt. *Cent. Text It./Italique* .25mm
 .38mm

O

6 pt. *Futura Roman/Romain* .08mm
 8 pt. *CG Trade Condensed/Condensé* .13mm
 10 pt. *Century Text Italic/Italique* .18mm
 12 pt. *Trium. Rom./Romain* .25mm
 .38mm

P

6 pt. *CG Trade Condensed/Condensé* .08mm
 8 pt. *Century Text Italic/Italique* .13mm
 10 pt. *Triumvirate Roman/Romain* .18mm
 12 pt. *Futura Roman/Romain* .25mm
 .38mm

SOLID — TEINTE PLATE

6 pt. *Century Text Italic/Italique* .08mm
 8 pt. *Triumvirate Roman/Romain* .13mm
 10 pt. *Futura Roman/Romain* .18mm
 12 pt. *CG Trade Condensed/Condensé* .25mm
 .38mm

A

B

C

D

E

F

G

H

I

J

S

COMPLIMENTARY COLOURS

COULEURS COMPLÉMENTAIRES

Colour No. Couleur

Name/Nom

C-5090 (91021)

Maroon Map

C-5460 (127)

Magenta Chart

C-5550 (415)

Purple

The non spectral colours such as purples are designated by their complementary wavelength. The use of the word “complementary” does not refer to the opposite of a given set of primaries.

Les couleurs non-spectrales tels les pourpres sont désignées par la longueur d’onde complémentaire. L’utilisation du terme “complémentaire” ne fait pas référence à ce qui constitue l’inverse des couleurs primaires.

TECHNICAL INFORMATION — DONNÉES TECHNIQUES

INK - ENCRE

PANTONE® * FORMUL (A/E)

COLOUR No. COULEUR : C-5090-91021

- .8880 parts Pantone Rubine Red
- .0560 parts Pantone Process Blue
- .0560 parts Pantone Mixing Black

AIM SOLID DENSITY
DENSITÉ TEINTE PLATE VISÉE : 1.06 W/H 0.98 D/S

GRAYNESS - NETTETÉ : N/A

HUE ERROR - DÉVIATION DE : N/A
TEINTE

INK EFFICIENCY : N/A
EFFICACITÉ DE L'ENCRE

DENSITOMETRY / DENSITOMÉTRIE

- CHANNEL-SÉLECTION: MAGENTA
- FILTER TYPE DE FILTRES: STATUS T
- FACTEUR n FACTOR: 2.7

* Pantone, Inc.'s check-standard trademark for colour reproduction and colour reproduction materials.
* La marque de Pantone, Inc. de contrôle uniforme pour la reproduction en couleur et les matériaux pour la reproduction en couleur.

CIE CHROMATICITY DIAGRAM(ME) DES CHROMATICITÉS CIE

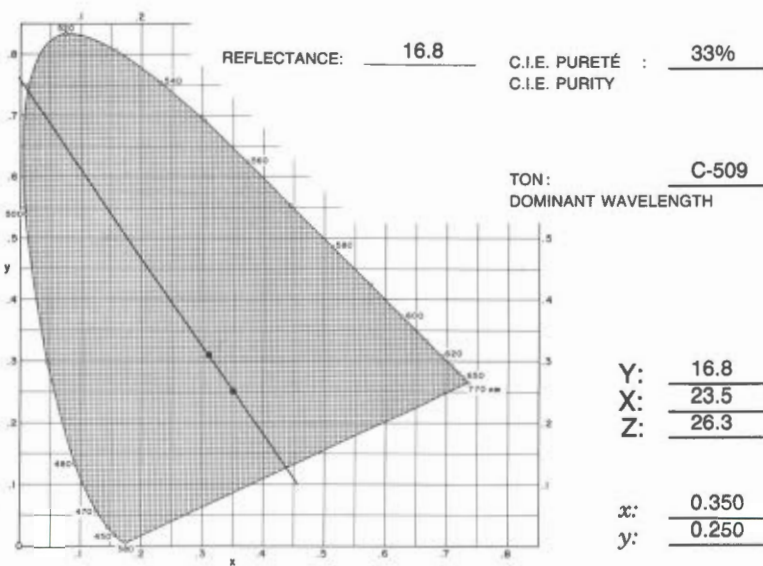

PAPER - PAPIER

GRADE / CATÉGORIE: W.S. STANDARD

TYPE: UNCOATED - NON COUCHÉ

REFLECTIVITÉ / REFLECTIVITY: 87%

OPACITÉ / OPACITY: 87%

% CONTRASTE/CONTRAST: 13%

PLATE - PLAQUE

SUBT. - SOUST.

TYPE: NEGATIVE

PRESS - PRESSE

• MEIHLE

• UNIT(É) #: LOWER/INFÉRIEURE

ID. PATCHES BLOCS IDEN.	% SCREEN TRAME	DENSITY DENSITÉ	% PRINT IMPRESSION
A	3	.11	6
B	6	.15	11
C	12	.21	20
D	22	.28	31
E	30	.36	41
F	40	.48	57
G	52	.61	74
H	66	.74	85
I	77	.81	93
J	87	.87	97
M	14	.25	28
N	27	.38	45
O	37	.47	56
P	51	.57	69
SOLID TEINTE PLATE	100	.93	100

The colour printed here was blended from, and should only be blended from PANTONE Basic Colours obtained from a PANTONE Licensed Printing Ink Manufacturer. Pantone, Inc. assumes no responsibility for the accuracy of the formulas or the colour reproduced.

La couleur ci-imprimée fut et devrait être mélangée seulement à partir des couleurs de base PANTONE obtenues d'un fabricant d'encre autorisé. La compagnie Pantone, Inc. n'assume aucune responsabilité quant à l'exactitude du mélange ou de la couleur obtenue.

RDD - DRD

COLOURS AND SCREENS

COULEURS ET TRAMES



BIANGULAR SCREENS — TRAMES BIANGULÉES

M

8 pt. Century Text Italic/Italique
8 pt. Triumvirate Roman/Romain
10 pt. Futura Roman/Romain
12 pt. CG Trade Condensed/Condensé



N

6 pt. Triumvirate Roman/Romain
8 pt. Futura Roman/Romain
10 pt. CG Trade Condensed/Condensé
12 pt. Cent. Text It./Italique

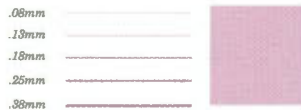

O

6 pt. Futura Roman/Romain
8 pt. CG Trade Condensed/Condensé
10 pt. Century Text Italic/Italique
12 pt. Trium. Rom./Romain

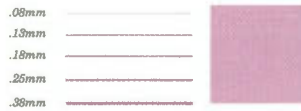

P

6 pt. CG Trade Condensed/Condensé
8 pt. Century Text Italic/Italique
10 pt. Triumvirate Roman/Romain
12 pt. Futura Roman/Romain

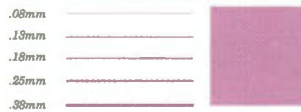

SOLID — TEINTE PLATE

6 pt. Century Text Italic/Italique
8 pt. Triumvirate Roman/Romain
10 pt. Futura Roman/Romain
12 pt. CG Trade Condensed/Condensé

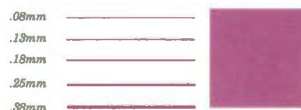

A
B
C
D
E
F
G
H
I
J
S

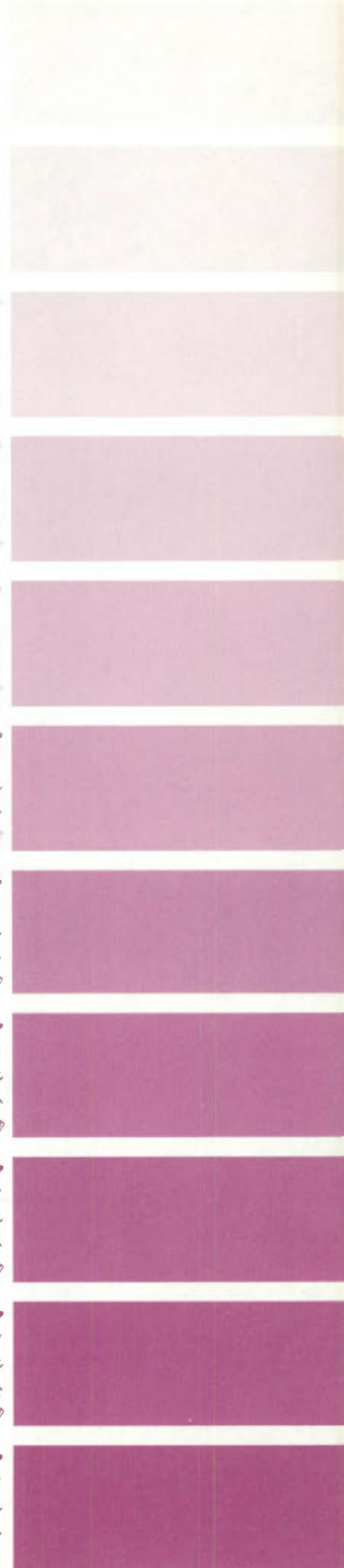

0 0 0 0
5 5 7 1 1 5

TECHNICAL INFORMATION — DONNÉES TECHNIQUES

INK - ENCRE

PANTONE® * FORMUL (A)
(E)

COLOUR No. COULEUR : C-5090-91021

- .8880 parts Pantone Rubine Red
- .0560 parts Pantone Process Blue
- .0560 parts Pantone Mixing Black

AIM SOLID DENSITY
DENSITÉ TEINTE PLATE VISÉE : 1.07 W/H 0.94 D/S

GRAYNESS - NETTETÉ : N/A

HUE ERROR - DÉVIATION DE : N/A
TEINTE

INK EFFICIENCY : N/A
EFFICACITÉ DE L'ENCRE

DENSITOMETRY / DENSITOMÉTRIE

- CHANNEL-SÉLECTION: MAGENTA
- FILTER TYPE DE FILTRES: STATUS T
- FACTEUR n FACTOR: 2.7

* Pantone, Inc.'s check-standard trademark for colour reproduction and colour reproduction materials.
* La marque de Pantone, Inc. de contrôle uniforme pour la reproduction en couleur et les matériaux pour la reproduction en couleur.

CIE CHROMATICITY DIAGRAM (ME) DES CHROMATICITÉS CIE

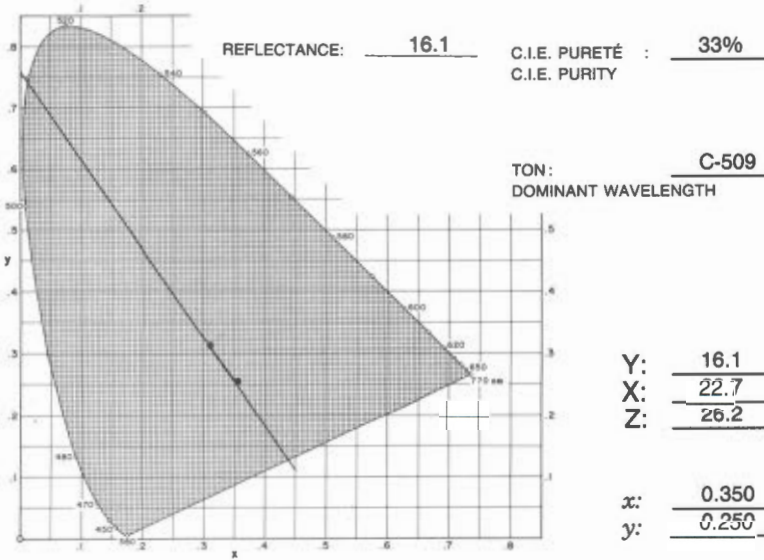

ID. PATCHES BLOCS IDEN.	% SCREEN TRAME	DENSITY DENSITÉ	% PRINT IMPRESSION
A	3	.11	6
B	6	.14	12
C	12	.20	19
D	22	.26	31
E	30	.34	41
F	40	.45	54
G	52	.58	71
H	66	.71	85
I	77	.79	92
J	87	.86	96
M	14	.25	28
N	27	.39	47
O	37	.45	55
P	51	.56	69
SOLID TEINTE PLATE	100	.90	100

PAPER - PAPIER

GRADE / CATÉGORIE: W.S. NEW BRITE

TYPE: UNCOATED - NON COUCHÉ

REFLECTIVITÉ / REFLECTIVITY: 85%

OPACITÉ / OPACITY: 85.5%

% CONTRASTE/CONTRAST: 12%

PLATE - PLAQUE

SUBT. - SOUST.

TYPE: NEGATIVE

PRESS - PRESSE

• MEIHLE

• UNIT(É) #: LOWER/INFÉRIEURE

The colour printed here was blended from, and should only be blended from PANTONE Basic Colours obtained from a PANTONE Licensed Printing Ink Manufacturer.
Pantone, Inc. assumes no responsibility for the accuracy of the formulas or the colour reproduced.

La couleur ci-imprimée fut et devrait être mélangée seulement à partir des couleurs de base PANTONE obtenues d'un fabricant d'encre autorisé.
La compagnie Pantone, Inc. n'assume aucune responsabilité quant à l'exactitude du mélange ou de la couleur obtenue.

TECHNICAL INFORMATION — DONNÉES TECHNIQUES

INK - ENCRE

PANTONE® * FORMUL (A)
(E)

COLOUR No. COULEUR : C-5460-127

AIM SOLID DENSITY
DENSITÉ TEINTE PLATE VISÉE : 0.92 W/H 0.86 D/S

GRAYNESS - NETTETÉ : N/A

HUE ERROR - DÉVIATION DE : N/A
TEINTE

INK EFFICIENCY : N/A
EFFICACITÉ DE L'ENCRE

DENSITOMETRY / DENSITOMÉTRIE

- CHANNEL-SÉLECTION: MAGENTA
- FILTER TYPE DE FILTRES: STATUS T
- FACTEUR n FACTOR: 2.7

* Pantone, Inc.'s check-standard trademark for colour reproduction and colour reproduction materials.

* La marque de Pantone, Inc. de contrôle uniforme pour la reproduction en couleur et les matériaux pour la reproduction en couleur.

CIE CHROMATICITY DIAGRAM(ME) DES CHROMATICITÉS CIE

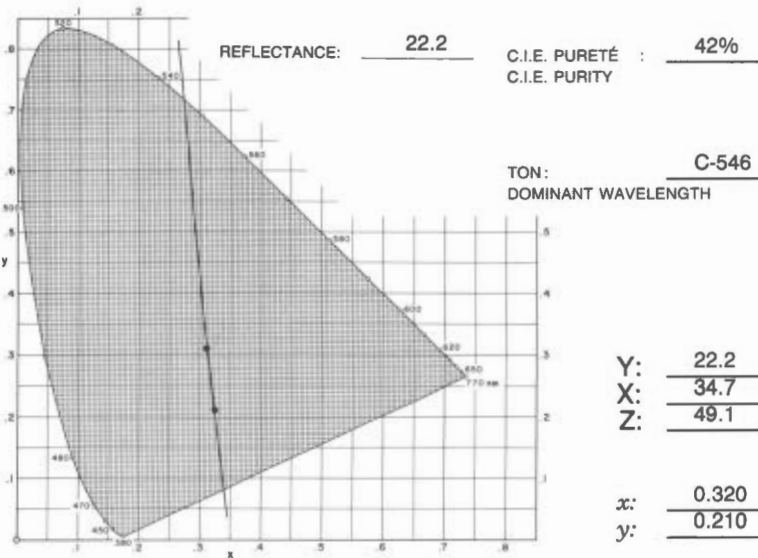

PAPER - PAPIER

GRADE / CATÉGORIE: W.S. STANDARD

TYPE: UNCOATED - NON COUCHÉ

REFLECTIVITÉ / REFLECTIVITY: 85%

OPACITÉ / OPACITY: 87%

% CONTRASTE/CONTRAST: 5%

PLATE - PLAQUE

TYPE: SUBT. - SOUST.

TYPE: NEGATIVE

PRESS - PRESSE

• MEIHLE

• UNIT(É) #: LOWER/INFÉRIEURE

ID. PATCHES BLOCS IDEN.	% SCREEN TRAME	DENSITY DENSITÉ	% PRINT IMPRESSION
A	3	.11	4
B	6	.15	10
C	12	.21	22
D	22	.32	37
E	30	.45	50
F	40	.58	72
G	52	.67	76
H	66	.86	92
I	77	.91	96
J	87	.96	100
M	14	.27	28
N	27	.45	50
O	37	.55	64
P	51	.67	76
SOLID TEINTE PLATE	100	.96	100

The colour printed here was blended from, and should only be blended from PANTONE Basic Colours obtained from a PANTONE Licensed Printing Ink Manufacturer. Pantone, Inc. assumes no responsibility for the accuracy of the formulas or the colour reproduced.

La couleur ci-imprimée fut et devrait être mélangée seulement à partir des couleurs de base PANTONE obtenues d'un fabricant d'encre autorisé. La compagnie Pantone, Inc. n'assume aucune responsabilité quant à l'exactitude du mélange ou de la couleur obtenue.

SURVEYS AND MAPPING BRANCH

DIRECTION DES LEVÉS ET DE LA CARTOGRAPHIE

AVRIL 1987
APRIL

0000
0000
0000
0000
0000
0000

RDD - DRD

COLOURS AND SCREENS

COULEURS ET TRAMES

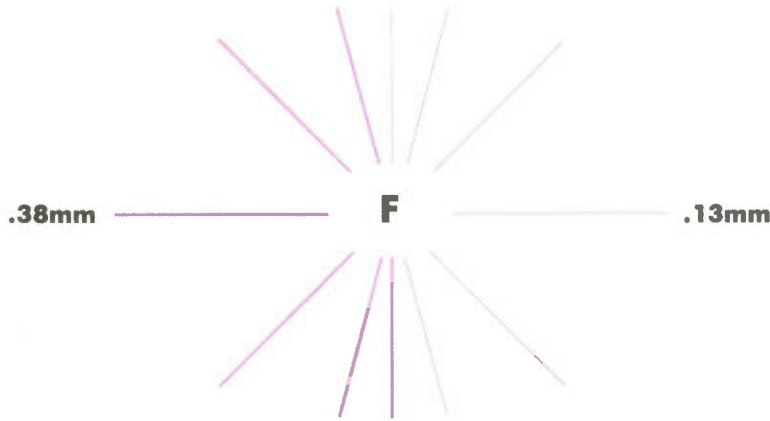

BIANGULAR SCREENS — TRAMES BIANGULÉES

M

6 pt. Century Text Italic/Italique
8 pt. Triumvirate Roman/Romain
10 pt. Futura Roman/Romain
12 pt. CG Trade Condensed/Condensé



N

6 pt. Triumvirate Roman/Romain
8 pt. Futura Roman/Romain
10 pt. CG Trade Condensed/Condensé
12 pt. Cent. Text It./Italique



O

6 pt. Futura Roman/Romain
8 pt. CG Trade Condensed/Condensé
10 pt. Century Text Italic/Italique
12 pt. Trium. Rom./Romain



P

6 pt. CG Trade Condensed/Condensé
8 pt. Century Text Italic/Italique
10 pt. Triumvirate Roman/Romain
12 pt. Futura Roman/Romain



SOLID — TEINTE PLATE

6 pt. Century Text Italic/Italique
8 pt. Triumvirate Roman/Romain
10 pt. Futura Roman/Romain
12 pt. CG Trade Condensed/Condensé



A

B

C

D

E

F

G

H

I

J

S

0000
0000
0000
0000
0000
0000
35705

TECHNICAL INFORMATION — DONNÉES TECHNIQUES

INK - ENCRE

PANTONE® * FORMUL (A)
E

COLOUR No. COULEUR : C-5460-127

AIM SOLID DENSITY
DENSITÉ TEINTE PLATE VISÉE : 0.91 W/H 0.87 D/S

GRAYNESS - NETTETÉ : N/A

HUE ERROR - DÉVIATION DE : N/A
TEINTE

INK EFFICIENCY
EFFICACITÉ DE L'ENCRE : N/A

DENSITOMETRY / DENSITOMÉTRIE

• CHANNEL-SÉLECTION: MAGENTA

• FILTER TYPE DE FILTRES: STATUS T

• FACTEUR n FACTOR: 2.7

* Pantone, Inc.'s check-standard trademark for colour reproduction and colour reproduction materials.
* La marque de Pantone, Inc. de contrôle uniforme pour la reproduction en couleur et les matériaux pour la reproduction en couleur.

CIE CHROMATICITY DIAGRAM(ME) DES CHROMATICITÉS CIE

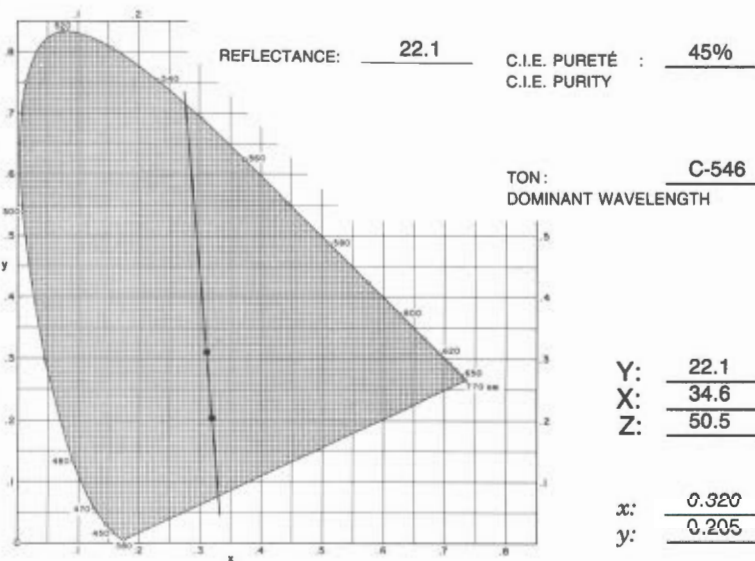

ID. PATCHES BLOCS IDEN.	% SCREEN TRAME	DENSITY DENSITÉ	% PRINT IMPRESSION
A	3	.11	7
B	6	.14	12
C	12	.22	23
D	22	.32	38
E	30	.42	54
F	40	.55	66
G	52	.66	74
H	66	.83	91
I	77	.88	96
J	87	.89	99
M	14	.27	29
N	27	.44	49
O	37	.53	61
P	51	.64	76
SOLID TEINTE PLATE	100	.95	100

PAPER - PAPIER

GRADE / CATÉGORIE: W.S. NEW BRITE

TYPE: UNCOATED - NON COUCHÉ

REFLECTIVITÉ / REFLECTIVITY: 85%

OPACITÉ / OPACITY: 85.5%

% CONTRASTE/CONTRAST: 7%

PLATE - PLAQUE

SUBT. - SOUST.

TYPE: NEGATIVE

PRESS - PRESSE

• MEIHLE

• UNIT(É) #: LOWER/INFÉRIEURE

The colour printed here was blended from, and should only be blended from PANTONE Basic Colours obtained from a PANTONE Licensed Printing Ink Manufacturer.
Pantone, Inc. assumes no responsibility for the accuracy of the formulas or the colour reproduced.

La couleur ci-imprimée fut et devrait être mélangée seulement à partir des couleurs de base PANTONE obtenues d'un fabricant d'encre autorisé.
La compagnie Pantone, Inc. n'assume aucune responsabilité quant à l'exactitude du mélange ou de la couleur obtenue.

TECHNICAL INFORMATION — DONNÉES TECHNIQUES

INK - ENCRE

PANTONE® * FORMUL (A/E)

___ .9850 parts Pantone Purple
___ .0150 parts Pantone Process Blue

COLOUR No. COULEUR : C-5550-415

AIM SOLID DENSITY
DENSITÉ TEINTE PLATE VISÉE : 0.98 W/H 0.93 D/S

GRAYNESS - NETTETÉ : N/A

HUE ERROR - DÉVIATION DE : N/A
TEINTE

INK EFFICIENCY : N/A
EFFICACITÉ DE L'ENCRE

DENSITOMETRY / DENSITOMÉTRIE

- CHANNEL-SÉLECTION: MAGENTA
- FILTER TYPE DE FILTRES: STATUS T
- FACTEUR n FACTOR: 2.7

* Pantone, Inc.'s check-standard trademark for colour reproduction and colour reproduction materials.
* La marque de Pantone, Inc. de contrôle uniforme pour la reproduction en couleur et les matériaux pour la reproduction en couleur.

CIE CHROMATICITY DIAGRAM(ME) DES CHROMATICITÉS CIE

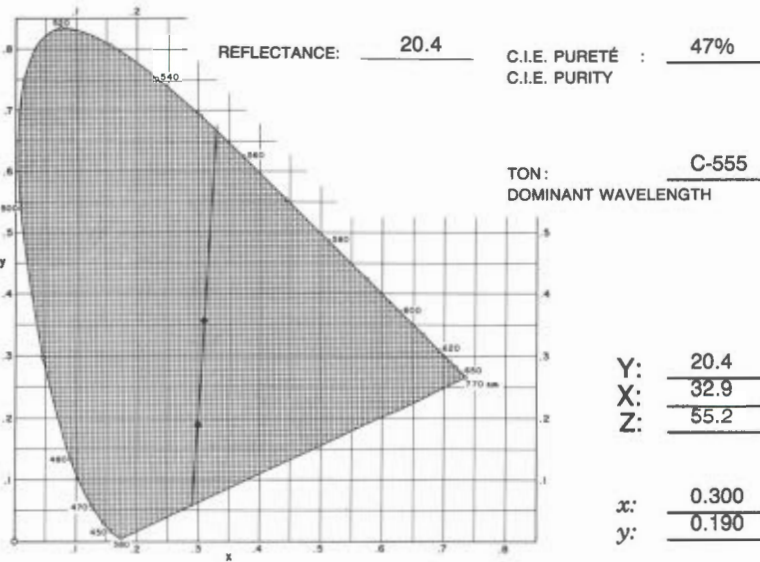

ID. PATCHES BLOCS IDEN.	% SCREEN FRAME	DENSITY DENSITÉ	% PRINT IMPRESSION
A	3	.11	7
B	6	.14	12
C	12	.18	18
D	22	.27	30
E	30	.33	40
F	40	.44	51
G	52	.56	64
H	66	.67	78
I	77	.75	88
J	87	.81	90
M	14	.25	27
N	27	.36	43
O	37	.42	51
P	51	.53	63
SOLID TEINTE PLATE	100	.88	100

PAPER - PAPIER

GRADE / CATÉGORIE: W.S. STANDARD

TYPE: UNCOATED - NON COUCHÉ

REFLECTIVITÉ / REFLECTIVITY: 85%

OPACITÉ / OPACITY: 87%

% CONTRASTE/CONTRAST: 15%

PLATE - PLAQUE

SUBT. - SOUST.

TYPE: NEGATIVE

PRESS - PRESSE

• MEIHLE

• UNIT(É) #: LOWER/INFÉRIEURE

The colour printed here was blended from, and should only be blended from PANTONE Basic Colours obtained from a PANTONE Licensed Printing Ink Manufacturer.
Pantone, Inc. assumes no responsibility for the accuracy of the formulas or the colour reproduced.

La couleur ci-imprimée fut et devrait être mélangée seulement à partir des couleurs de base PANTONE obtenues d'un fabricant d'encre autorisé.
La compagnie Pantone, Inc. n'assume aucune responsabilité quant à l'exactitude du mélange ou de la couleur obtenue.

RDD - DRD

COLOURS AND SCREENS

COULEURS ET TRAMES

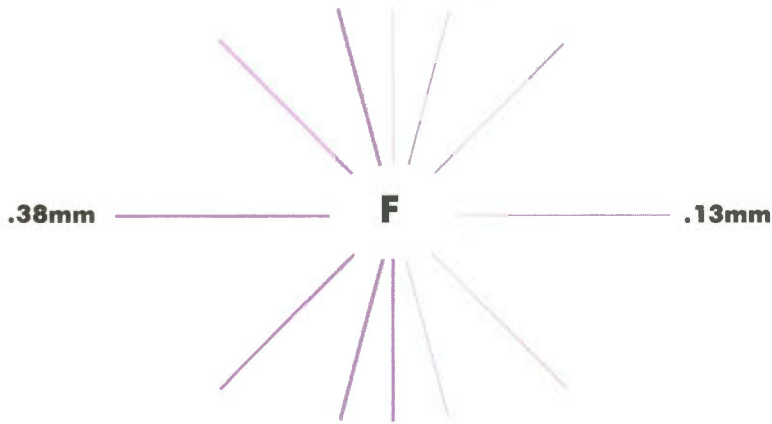

BIANGULAR SCREENS — TRAMES BIANGULÉES

M

6 pt. *Century Text Italic/Italique*
8 pt. *Triumvirate Roman/Romain*
10 pt. *Futura Roman/Romain*
12 pt. *CG Trade Condensed/Condensé*

.08mm
.13mm
.18mm
.25mm
.38mm

N

6 pt. *Triumvirate Roman/Romain*
8 pt. *Futura Roman/Romain*
10 pt. *CG Trade Condensed/Condensé*
12 pt. *Cent. Text It./Italique*

.08mm
.13mm
.18mm
.25mm
.38mm

O

6 pt. *Futura Roman/Romain*
8 pt. *CG Trade Condensed/Condensé*
10 pt. *Century Text Italic/Italique*
12 pt. *Trium. Rom./Romain*

.08mm
.13mm
.18mm
.25mm
.38mm

P

6 pt. *CG Trade Condensed/Condensé*
8 pt. *Century Text Italic/Italique*
10 pt. *Triumvirate Roman/Romain*
12 pt. *Futura Roman/Romain*

.08mm
.13mm
.18mm
.25mm
.38mm

SOLID — TEINTE PLATE

6 pt. *Century Text Italic/Italique*
8 pt. *Triumvirate Roman/Romain*
10 pt. *Futura Roman/Romain*
12 pt. *CG Trade Condensed/Condensé*

.08mm
.13mm
.18mm
.25mm
.38mm

A
B
C
D
E
F
G
H
I
J
S

0 0 0 0
0 0 0 0
0 0 0 0
0 0 0 0
0 0 0 0

TECHNICAL INFORMATION — DONNÉES TECHNIQUES

INK - ENCRE

PANTONE® * FORMUL (A)_E

COLOUR No. COULEUR : C-5550-415

— .9850 parts Pantone Purple
— .0150 parts Pantone Process Blue

AIM SOLID DENSITY
DENSITÉ TEINTE PLATE VISÉE : 1.02 W/H 0.98 D/S

GRAYNESS - NETTETÉ : N/A

HUE ERROR - DÉVIATION DE : N/A
TEINTE

INK EFFICIENCY : N/A
EFFICACITÉ DE L'ENCRE

DENSITOMETRY / DENSITOMÉTRIE

• CHANNEL-SÉLECTION: MAGENTA

• FILTER TYPE DE FILTRES: STATUS T

• FACTEUR n FACTOR: 2.7

* Pantone, Inc.'s check-standard trademark for colour reproduction and colour reproduction materials.
* La marque de Pantone, Inc. de contrôle uniforme pour la reproduction en couleur et les matériaux pour la reproduction en couleur.

CIE CHROMATICITY DIAGRAM (ME) DES CHROMATICITÉS CIE

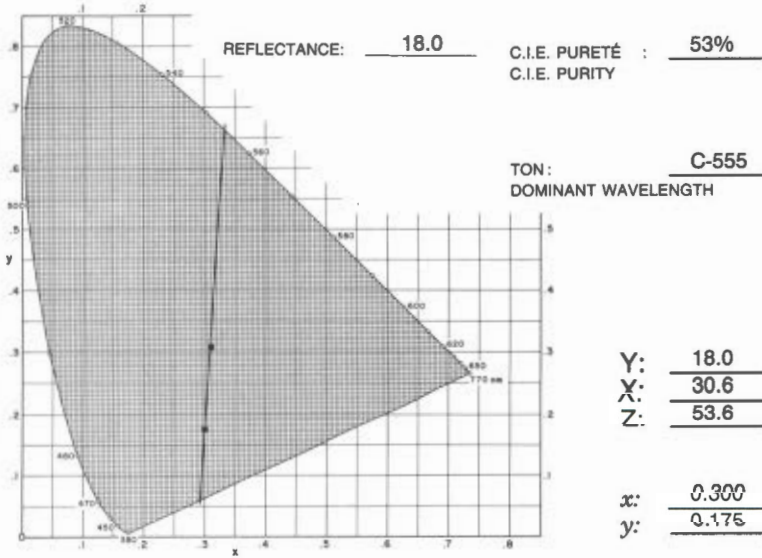

ID. PATCHES BLOCS IDEN.	% SCREEN TRAME	DENSITY DENSITÉ	% PRINT IMPRESSION
A	3	.11	5
B	6	.15	9
C	12	.20	18
D	22	.28	31
E	30	.36	42
F	40	.46	53
G	52	.59	69
H	66	.68	79
I	77	.77	89
J	87	.81	93
M	14	.26	27
N	27	.38	45
O	37	.46	54
P	51	.56	66
SOLID TEINTE PLATE	100	.90	100

PAPER - PAPIER

GRADE / CATÉGORIE: W.S. NEW BRITE

TYPE: UNCOATED - NON COUCHÉ

REFLECTIVITÉ / REFLECTIVITY: 85%

OPACITÉ / OPACITY: 85.5%

% CONTRASTE/CONTRAST: 14%

PLATE - PLAQUE

TYPE: SUBT. - SOUST.

TYPE: NEGATIVE

PRESS - PRESSE

• MEIHLE

• UNIT(É) #: LOWER/INFÉRIEURE

The colour printed here was blended from, and should only be blended from PANTONE Basic Colours obtained from a PANTONE Licensed Printing Ink Manufacturer.
Pantone, Inc. assumes no responsibility for the accuracy of the formulas or the colour reproduced.

La couleur ci-imprimée fut et devrait être mélangée seulement à partir des couleurs de base PANTONE obtenues d'un fabricant d'encre autorisé.
La compagnie Pantone, Inc. n'assume aucune responsabilité quant à l'exactitude du mélange ou de la couleur obtenue.

RDD - DRD

COLOURS AND SCREENS

COULEURS ET TRAMES

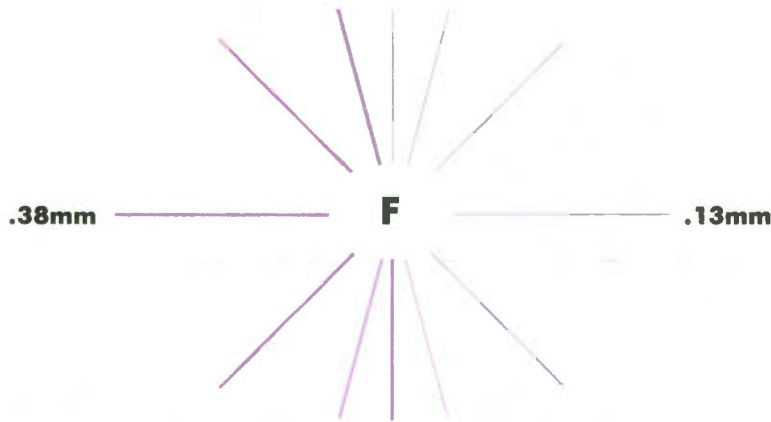

BIANGULAR SCREENS — TRAMES BIANGULÉES

M

4 pt. Century Text Italic/Italique
8 pt. Triumvirate Roman/Romain
10 pt. Futura Roman/Romain
12 pt. CG Trade Condensed/Condensé



N

6 pt. Triumvirate Roman/Romain
8 pt. Futura Roman/Romain
10 pt. CG Trade Condensed/Condensé
12 pt. Cent. Text It./Italique



O

6 pt. Futura Roman/Romain
8 pt. CG Trade Condensed/Condensé
10 pt. Century Text Italic/Italique
12 pt. Trium. Rom./Romain



P

6 pt. CG Trade Condensed/Condensé
8 pt. Century Text Italic/Italique
10 pt. Triumvirate Roman/Romain
12 pt. Futura Roman/Romain



SOLID — TEINTE PLATE

6 pt. Century Text Italic/Italique
8 pt. Triumvirate Roman/Romain
10 pt. Futura Roman/Romain
12 pt. CG Trade Condensed/Condensé



A

B

C

D

E

F

G

H

I

J

S

TECHNICAL INFORMATION — DONNÉES TECHNIQUES

INK - ENCRE

PANTONE® * FORMUL (A/E)

COLOUR No. COULEUR : C-5550-415

___ .9850 parts Pantone Purple
___ .0150 parts Pantone Process Blue

AIM SOLID DENSITY
DENSITÉ TEINTE PLATE VISÉE : 1.05 W/H 0.97 D/S

GRAYNESS - NETTETÉ : N/A

HUE ERROR - DÉVIATION DE : N/A
TEINTE

INK EFFICIENCY : N/A
EFFICACITÉ DE L'ENCRE

DENSITOMETRY / DENSITOMÉTRIE

• CHANNEL-SÉLECTION: MAGENTA

• FILTER TYPE DE FILTRES: STATUS T

• FACTEUR n FACTOR: 2.7

* Pantone, Inc.'s check-standard trademark for colour reproduction and colour reproduction materials.

* La marque de Pantone, Inc. de contrôle uniforme pour la reproduction en couleur et les matériaux pour la reproduction en couleur.

CIE CHROMATICITY DIAGRAM(ME) DES CHROMATICITÉS CIE

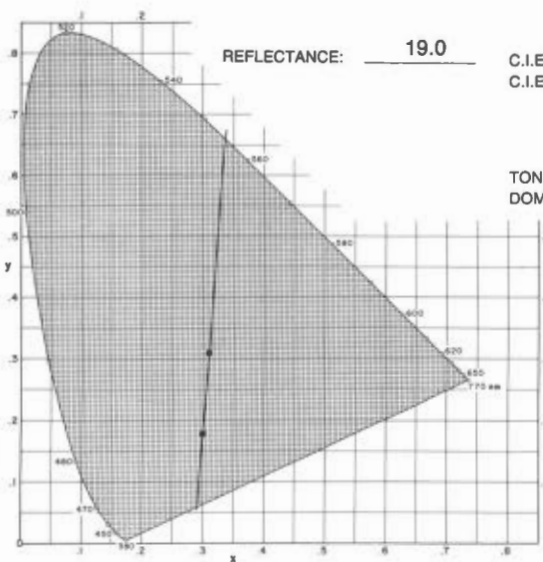

REFLECTANCE: 19.0 C.I.E. PURETÉ : 49%
C.I.E. PURITY

TON: C-555
DOMINANT WAVELENGTH

Y: 19.0
X: 31.6
Z: 53.2

x: 0.300
y: 0.185

PAPER - PAPIER

GRADE / CATÉGORIE: CHART

TYPE: UNCOATED - NON COUCHÉ

REFLECTIVITÉ / REFLECTIVITY: 83%

OPACITÉ / OPACITY: 96.5%

% CONTRASTE/CONTRAST: 20%

PLATE - PLAQUE

SUBT. - SOUST.

TYPE: NEGATIVE

PRESS - PRESSE

• MEIHLE

• UNIT(É) #: LOWER/INFÉRIEURE

ID. PATCHES BLOCS IDEN.	% SCREEN TRAME	DENSITY DENSITÉ	% PRINT IMPRESSION
A	3	.09	5
B	6	.12	11
C	12	.18	18
D	22	.24	28
E	30	.32	38
F	40	.41	51
G	52	.51	62
H	66	.64	76
I	77	.73	86
J	87	.84	93
M	14	.22	24
N	27	.33	40
O	37	.40	49
P	51	.50	50
SOLID TEINTE PLATE	100	.91	100

The colour printed here was blended from, and should only be blended from PANTONE Basic Colours obtained from a PANTONE Licensed Printing Ink Manufacturer. Pantone, Inc. assumes no responsibility for the accuracy of the formulas or the colour reproduced.

La couleur ci-imprimée fut et devrait être mélangée seulement à partir des couleurs de base PANTONE obtenues d'un fabricant d'encre autorisé. La compagnie Pantone, Inc. n'assume aucune responsabilité quant à l'exactitude du mélange ou de la couleur obtenue.

COEUR
COEUR
COEUR
COEUR
COEUR

RDD - DRD

COLOURS AND SCREENS

COULEURS ET TRAMES

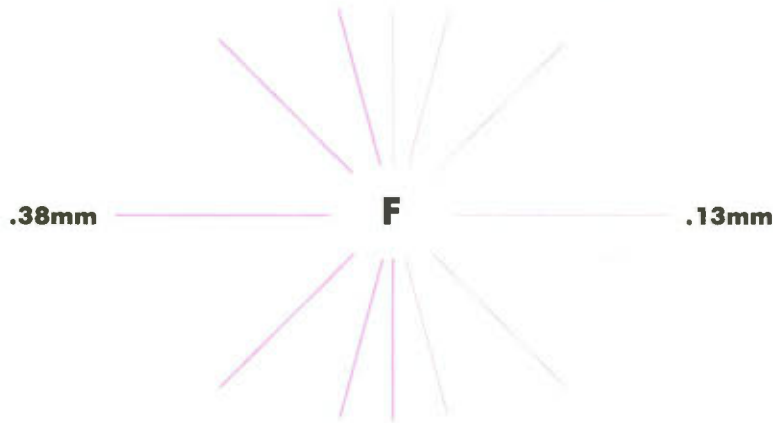

BIANGULAR SCREENS — TRAMES BIANGULÉES

M

6 pt. Triumvirate Roman/Romain
8 pt. Futura Roman/Romain
10 pt. CG Trade Condensed/Condensé
12 pt. CG Trade Condensed/Condensé

.08mm
.13mm
.18mm
.25mm
.38mm

N

6 pt. Triumvirate Roman/Romain
8 pt. Futura Roman/Romain
10 pt. CG Trade Condensed/Condensé
12 pt. Cent. Text Italic/Italique

.08mm
.13mm
.18mm
.25mm
.38mm

O

6 pt. Futura Roman/Romain
8 pt. CG Trade Condensed/Condensé
10 pt. Century Text Italic/Italique
12 pt. Trium. Rom./Romain

.08mm
.13mm
.18mm
.25mm
.38mm

P

6 pt. CG Trade Condensed/Condensé
8 pt. Century Text Italic/Italique
10 pt. Triumvirate Roman/Romain
12 pt. Futura Roman/Romain

.08mm
.13mm
.18mm
.25mm
.38mm

SOLID — TEINTE PLATE

6 pt. Century Text Italic/Italique
8 pt. Triumvirate Roman/Romain
10 pt. Futura Roman/Romain
12 pt. CG Trade Condensed/Condensé

.08mm
.13mm
.18mm
.25mm
.38mm

A

B

C

D

E

F

G

H

I

J

S

000000
857015

EARTH COLOURS - COULEURS DE TERRE

Colour No. Couleur	Name/Nom
M-5751 (136)	Buff Chart
M-5752 (2405)	Buff Jog
M-5760 (5823)	Brown Jog
M-5770 (5834)	Brown Jog Old
M-5811 (137)	Buff First
M-5812 (138)	Buff Third
M-5813 (131)	Brown Transparent
M-5831 (139)	Buff Second
M-5832 (464)	Beige Mountain
M-5860 (130)	Brown Contour
M-5950 (133)	Brown Chestnut

TECHNICAL INFORMATION — DONNÉES TECHNIQUES

INK - ENCRE

PANTONE® * FORMUL (A/E)

COLOUR No. COULEUR : M-5751-136

- .0750 parts Pantone Process Yellow
- .0160 parts Pantone Warm Red
- .0090 parts Pantone Process Black
- .9000 parts Pantone Extender

AIM SOLID DENSITY
DENSITÉ TEINTE PLATE VISÉE : 0.33 W/H 0.26 D/S

GRAYNESS - NETTETÉ : N/A

HUE ERROR - DÉVIATION DE : N/A
TEINTE

INK EFFICIENCY : N/A
EFFICACITÉ DE L'ENCRE

DENSITOMETRY / DENSITOMÉTRIE

- CHANNEL-SÉLECTION: YELLOW/JAUNE
- FILTER TYPE DE FILTRES: STATUS T
- FACTEUR n FACTOR: 2.7

* Pantone, Inc.'s check-standard trademark for colour reproduction and colour reproduction materials.

* La marque de Pantone, Inc. de contrôle uniforme pour la reproduction en couleur et les matériaux pour la reproduction en couleur.

CIE CHROMATICITY DIAGRAM(ME) DES CHROMATICITÉS CIE

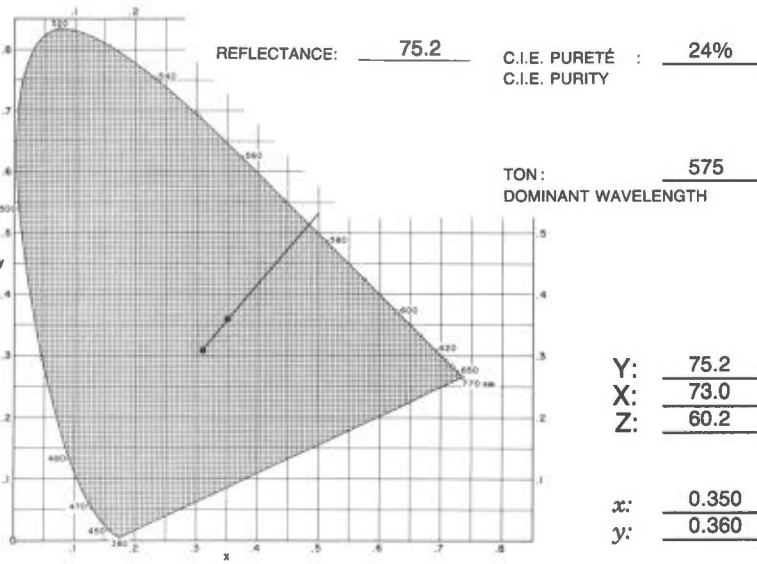

PAPER - PAPIER

GRADE / CATÉGORIE: W.S. STANDARD

TYPE: UNCOATED - NON COUCHÉ

REFLECTIVITÉ / REFLECTIVITY: 79%

OPACITÉ / OPACITY: 87%

% CONTRASTE/CONTRAST: 10%

PLATE - PLAQUE

SUBT. - SOUST.

TYPE: NEGATIVE

PRESS - PRESSE

• MEIHLE

• UNIT(É) #: LOWER/INFÉRIEURE

ID. PATCHES BLOCS IDEN.	% SCREEN TRAME	DENSITY DENSITÉ	% PRINT IMPRESSION
A	3	.10	1
B	6	.11	6
C	12	.12	14
D	22	.15	25
E	30	.17	37
F	40	.19	48
G	52	.21	60
H	66	.25	72
I	77	.28	86
J	87	.29	92
M	14	.13	17
N	27	.16	34
O	37	.18	44
P	51	.21	53
SOLID TEINTE PLATE	100	.31	100

The colour printed here was blended from, and should only be blended from PANTONE Basic Colours obtained from a PANTONE Licensed Printing Ink Manufacturer. Pantone, Inc. assumes no responsibility for the accuracy of the formulas or the colour reproduced.

La couleur ci-imprimée fut et devrait être mélangée seulement à partir des couleurs de base PANTONE obtenues d'un manufacturier d'encre autorisé. La compagnie Pantone, Inc. n'assume aucune responsabilité quant à l'exactitude du mélange ou de la couleur obtenue.

RDD - DRD

COLOURS AND SCREENS

COULEURS ET TRAMES

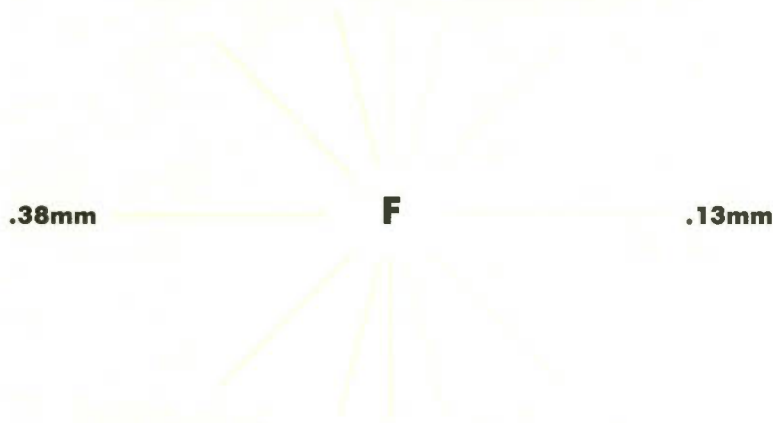

BIANGULAR SCREENS — TRAMES BIANGULÉES

M

4 pt. Century Condensed	.06mm	
6 pt. Times Ten Bold	.13mm	
10 pt. Times Ten Bold	.18mm	
12 pt. Times Ten Bold	.25mm	
14 pt. Times Ten Bold	.38mm	

N

4 pt. Century Condensed	.06mm	
6 pt. Times Ten Bold	.13mm	
10 pt. Times Ten Bold	.18mm	
12 pt. Times Ten Bold	.25mm	
14 pt. Times Ten Bold	.38mm	

O

4 pt. Century Condensed	.06mm	
6 pt. Times Ten Bold	.13mm	
10 pt. Times Ten Bold	.18mm	
12 pt. Times Ten Bold	.25mm	
14 pt. Times Ten Bold	.38mm	

P

4 pt. Century Condensed	.06mm	
6 pt. Times Ten Bold	.13mm	
10 pt. Times Ten Bold	.18mm	
12 pt. Times Ten Bold	.25mm	
14 pt. Times Ten Bold	.38mm	

SOLID — TEINTE PLATE

4 pt. Century Condensed	.06mm	
6 pt. Times Ten Bold	.13mm	
10 pt. Times Ten Bold	.18mm	
12 pt. Times Ten Bold	.25mm	
14 pt. Times Ten Bold	.38mm	

A
B
C
D
E
F
G
H
I
J
S

TECHNICAL INFORMATION — DONNÉES TECHNIQUES

INK - ENCRE

PANTONE® * FORMUL (A/E)

COLOUR No. COULEUR : M-5751-136

- .0750 parts Pantone Process Yellow
- .0160 parts Pantone Warm Red
- .0090 parts Pantone Process Black
- .9000 parts Pantone Extender

AIM SOLID DENSITY
DENSITÉ TEINTE PLATE VISÉE : 0.35 W/H 0.34 D/S

GRAYNESS - NETTETÉ : N/A

HUE ERROR - DÉVIATION DE : N/A
TEINTE

INK EFFICIENCY : N/A
EFFICACITÉ DE L'ENCRE

DENSITOMETRY / DENSITOMÉTRIE

- CHANNEL-SÉLECTION: YELLOW/JAUNE
- FILTER TYPE DE FILTRES: STATUS T
- FACTEUR n FACTOR: 2.7

* Pantone, Inc.'s check-standard trademark for colour reproduction and colour reproduction materials.

* La marque de Pantone, Inc. de contrôle uniforme pour la reproduction en couleur et les matériaux pour la reproduction en couleur.

CIE CHROMATICITY DIAGRAM(ME) DES CHROMATICITÉS CIE

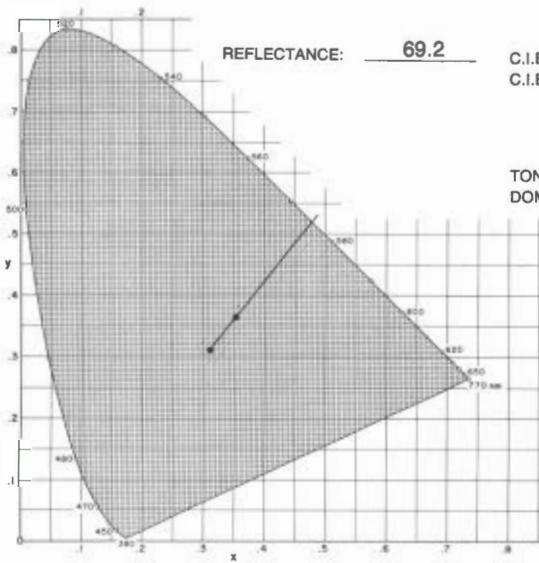

ID. PATCHES BLOCS IDEN.	% SCREEN TRAME	DENSITY DENSITÉ	% PRINT IMPRESSION
A	3	.09	1
B	6	.10	4
C	12	.11	13
D	22	.14	22
E	30	.15	33
F	40	.18	44
G	52	.22	58
H	66	.26	75
I	77	.27	81
J	87	.30	86
M	14	.12	15
N	27	.16	32
O	37	.19	44
P	51	.22	55
SOLID TEINTE PLATE	100	.33	100

PAPER - PAPIER

GRADE / CATÉGORIE: W.S. NEW BRITE

TYPE: UNCOATED - NON COUCHÉ

REFLECTIVITÉ / REFLECTIVITY: 83%

OPACITÉ / OPACITY: 85.5%

% CONTRASTE/CONTRAST: 22%

PLATE - PLAQUE

SUBT. - SOUST.

TYPE: NEGATIVE

PRESS - PRESSE

• MEIHLE

• UNIT(É) #: LOWER/INFÉRIEURE

The colour printed here was blended from, and should only be blended from PANTONE Basic Colours obtained from a PANTONE Licensed Printing Ink Manufacturer. Pantone, Inc. assumes no responsibility for the accuracy of the formulas or the colour reproduced.

La couleur ci-imprimée fut et devrait être mélangée seulement à partir des couleurs de base PANTONE obtenues d'un fabricant d'encre autorisé. La compagnie Pantone, Inc. n'assume aucune responsabilité quant à l'exactitude du mélange ou de la couleur obtenue.

RDD - DRD
COLOURS AND SCREENS
COULEURS ET TRAMES

.38mm

F

.13mm

BIANGULAR SCREENS — TRAMES BIANGULÉES

M

.08mm
.13mm
.18mm
.25mm
.38mm

N

.08mm
.13mm
.18mm
.25mm
.38mm

O

.08mm
.13mm
.18mm
.25mm
.38mm

P

.08mm
.13mm
.18mm
.25mm
.38mm

SOLID — TEINTE PLATE

4 pt. Times Ten Roman/Condensed
6 pt. Times Ten Roman/Condensed
10 pt. Futura Roman/Roman
12 pt. CG Trade Condensed/Condensé

.08mm
.13mm
.18mm
.25mm
.38mm

A

B

C

D

E

F

G

H

I

J

S

TECHNICAL INFORMATION — DONNÉES TECHNIQUES

INK - ENCRE

PANTONE® * FORMUL (A_E)

COLOUR No. COULEUR : M-5751-136

- .0750 parts Pantone Process Yellow
- .0160 parts Pantone Warm Red
- .0090 parts Pantone Process Black
- .9000 parts Pantone Extender

AIM SOLID DENSITY
DENSITÉ TEINTE PLATE VISÉE: — W/H 0.39 D/S

GRAYNESS - NETTETÉ : N/A

HUE ERROR - DÉVIATION DE : N/A
TEINTE

INK EFFICIENCY : N/A
EFFICACITÉ DE L'ENCRE

DENSITOMETRY / DENSITOMÉTRIE

- CHANNEL-SÉLECTION: YELLOW/JAUNE
- FILTER TYPE DE FILTRES: STATUS T
- FACTEUR n FACTOR: 2.7

* Pantone, Inc.'s check-standard trademark for colour reproduction and colour reproduction materials.
* La marque de Pantone, Inc. de contrôle uniforme pour la reproduction en couleur et les matériaux pour la reproduction en couleur.

CIE CHROMATICITY DIAGRAM(ME) DES CHROMATICITÉS CIE

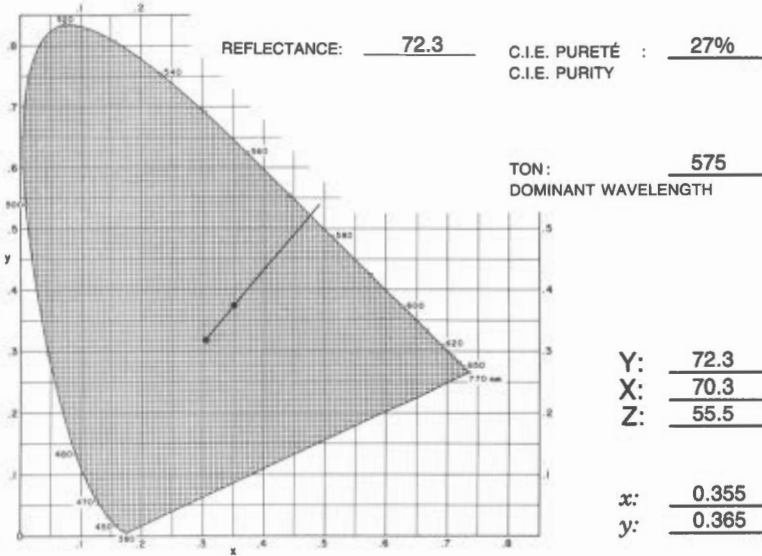

ID. PATCHES BLOCS IDEN.	% SCREEN TRAME	DENSITY DENSITÉ	% PRINT IMPRESSION
A	3	.12	4
B	6	.12	8
C	12	.14	14
D	22	.16	28
E	30	.19	37
F	40	.22	47
G	52	.24	58
H	66	.27	73
I	77	.29	83
J	87	.31	87
M	14	.15	18
N	27	.18	33
O	37	.21	43
P	51	.24	57
SOLID TEINTE PLATE	100	.34	100

PAPER - PAPIER

GRADE / CATÉGORIE: CHART

TYPE: UNCOATED - NON COUCHÉ

REFLECTIVITÉ / REFLECTIVITY: 77%

OPACITÉ / OPACITY: 96.5%

% CONTRASTE/CONTRAST: 15%

PLATE - PLAQUE

SUBT. - SOUST.

TYPE: NEGATIVE

PRESS - PRESSE

• MEIHLE

• UNIT(É) #: LOWER/INFÉRIEURE

The colour printed here was blended from, and should only be blended from PANTONE Basic Colours obtained from a PANTONE Licensed Printing Ink Manufacturer.
Pantone, Inc. assumes no responsibility for the accuracy of the formulas or the colour reproduced.

La couleur ci-imprimée fut et devrait être mélangée seulement à partir des couleurs de base PANTONE obtenues d'un fabricant d'encre autorisé.
La compagnie Pantone, Inc. n'assume aucune responsabilité quant à l'exactitude du mélange ou de la couleur obtenue.

RDD - DRD

COLOURS AND SCREENS

COULEURS ET TRAMES

.38mm

F

.13mm

BIANGULAR SCREENS — TRAMES BIANGULÉES

M

- .08mm
- .13mm
- .18mm
- .25mm
- .38mm

N

- .08mm
- .13mm
- .18mm
- .25mm
- .38mm

O

- .08mm
- .13mm
- .18mm
- .25mm
- .38mm

P

- .08mm
- .13mm
- .18mm
- .25mm
- .38mm

SOLID — TEINTE PLATE

- 4 pt. Titania Black/Noir
- 6 pt. Titanium Compound/Composé
- 10 pt. Fuller's Earth/Argile
- 12 pt. CO Trade Condensed/Condensé

- .08mm
- .13mm
- .18mm
- .25mm
- .38mm

A

B

C

D

E

F

G

H

I

J

S

TECHNICAL INFORMATION — DONNÉES TECHNIQUES

INK - ENCRE

PANTONE® * FORMUL (A/E)

COLOUR No. COULEUR : M-5752-2405

AIM SOLID DENSITY
DENSITÉ TEINTE PLATE VISÉE : 0.38 W/H 0.35 D/S

GRAYNESS - NETTETÉ : N/A

HUE ERROR - DÉVIATION DE : N/A
TEINTE

INK EFFICIENCY : N/A
EFFICACITÉ DE L'ENCRE

DENSITOMETRY / DENSITOMÉTRIE

• CHANNEL-SÉLECTION: YELLOW/JAUNE

• FILTER TYPE DE FILTRES: STATUS T

• FACTEUR n FACTOR: 2.7

* Pantone, Inc.'s check-standard trademark for colour reproduction and colour reproduction materials.
* La marque de Pantone, Inc. de contrôle uniforme pour la reproduction en couleur et les matériaux pour la reproduction en couleur.

CIE CHROMATICITY DIAGRAM(ME) DES CHROMATICITÉS CIE

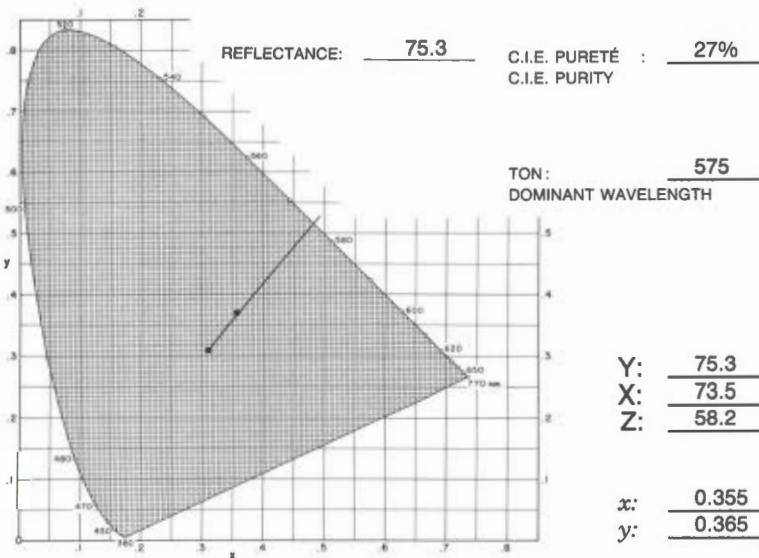

PAPER - PAPIER

GRADE / CATÉGORIE: W.S. STANDARD

TYPE: UNCOATED - NON COUCHÉ

REFLECTIVITÉ / REFLECTIVITY: 79%

OPACITÉ / OPACITY: 87%

% CONTRASTE/CONTRAST: 16%

PLATE - PLAQUE

TYPE: SUBT. - SOUST.

TYPE: NEGATIVE

PRESS - PRESSE

• MEHLE

• UNIT(É) #: LOWER/INFÉRIEURE

ID. PATCHES BLOCS IDEN.	% SCREEN TRAME	DENSITY DENSITÉ	% PRINT IMPRESSION
A	3	.11	1
B	6	.12	2
C	12	.14	12
D	22	.15	23
E	30	.20	38
F	40	.22	51
G	52	.26	61
H	66	.29	76
I	77	.30	84
J	87	.30	88
M	14	.14	13
N	27	.17	34
O	37	.20	44
P	51	.22	55
SOLID TEINTE PLATE	100	.34	100

The colour printed here was blended from, and should only be blended from PANTONE Basic Colours obtained from a PANTONE Licensed Printing Ink Manufacturer.
Pantone, Inc. assumes no responsibility for the accuracy of the formulas or the colour reproduced.

La couleur ci-imprimée fut et devrait être mélangée seulement à partir des couleurs de base PANTONE obtenues d'un fabricant d'encre autorisé.
La compagnie Pantone, Inc. n'assume aucune responsabilité quant à l'exactitude du mélange ou de la couleur obtenue.

SURVEYS AND MAPPING BRANCH
DIRECTION DES LEVÉS ET DE LA CARTOGRAPHIE

AVRIL 1987
APRIL

RDD - DRD

COLOURS AND SCREENS

COULEURS ET TRAMES

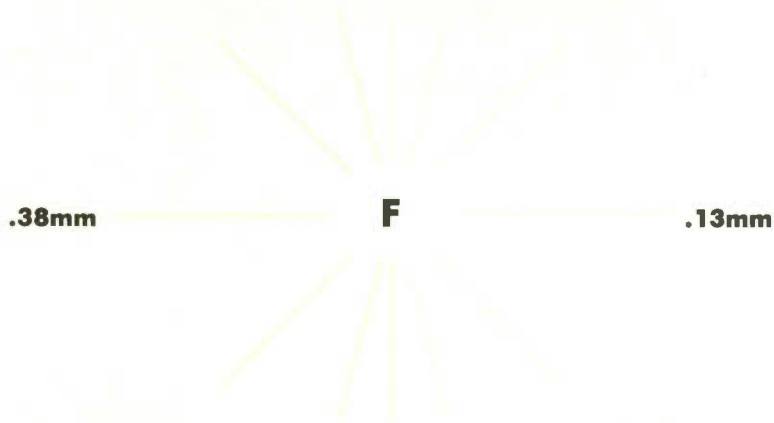

BIANGULAR SCREENS — TRAMES BIANGULÉES

M

12 pt. Century Text/Text Condensed	.08mm	
12 pt. Century Text Condensed/Condensed	.15mm	
12 pt. Futura Roman/Romain	.18mm	
12 pt. CG Trade Condensed/Condensé	.25mm	
12 pt. CG Trade Condensed/Condensé	.38mm	

N

12 pt. Century Text/Text Condensed	.08mm	
12 pt. Century Text Condensed/Condensed	.15mm	
12 pt. Futura Roman/Romain	.18mm	
12 pt. CG Trade Condensed/Condensé	.25mm	
12 pt. CG Trade Condensed/Condensé	.38mm	

O

12 pt. Century Text/Text Condensed	.08mm	
12 pt. Century Text Condensed/Condensed	.15mm	
12 pt. Futura Roman/Romain	.18mm	
12 pt. CG Trade Condensed/Condensé	.25mm	
12 pt. CG Trade Condensed/Condensé	.38mm	

P

12 pt. Century Text/Text Condensed	.08mm	
12 pt. Century Text Condensed/Condensed	.15mm	
12 pt. Futura Roman/Romain	.18mm	
12 pt. CG Trade Condensed/Condensé	.25mm	
12 pt. CG Trade Condensed/Condensé	.38mm	

SOLID — TEINTE PLATE

12 pt. Century Text/Text Condensed	.08mm	
12 pt. Century Text Condensed/Condensed	.15mm	
12 pt. Futura Roman/Romain	.18mm	
12 pt. CG Trade Condensed/Condensé	.25mm	
12 pt. CG Trade Condensed/Condensé	.38mm	

A
B
C
D
E
F
G
H
I
J
S



TECHNICAL INFORMATION — DONNÉES TECHNIQUES

INK - ENCRE

PANTONE® * FORMUL (A)
(E)

COLOUR No. COULEUR : M-5752-2405

AIM SOLID DENSITY
DENSITÉ TEINTE PLATE VISÉE : 0.40 W/H 0.38 D/S

GRAYNESS - NETTETÉ : N/A

HUE ERROR - DÉVIATION DE : N/A
TEINTE

INK EFFICIENCY
EFFICACITÉ DE L'ENCRE : N/A

DENSITOMETRY / DENSITOMÉTRIE

• CHANNEL-SÉLECTION: YELLOW/JAUNE

• FILTER TYPE DE FILTRES: STATUS T

• FACTEUR n FACTOR: 2.7

* Pantone, Inc.'s check-standard trademark for colour reproduction and colour reproduction materials.

* La marque de Pantone, Inc. de contrôle uniforme pour la reproduction en couleur et les matériaux pour la reproduction en couleur.

CIE CHROMATICITY DIAGRAM(ME) DES CHROMATICITÉS CIE

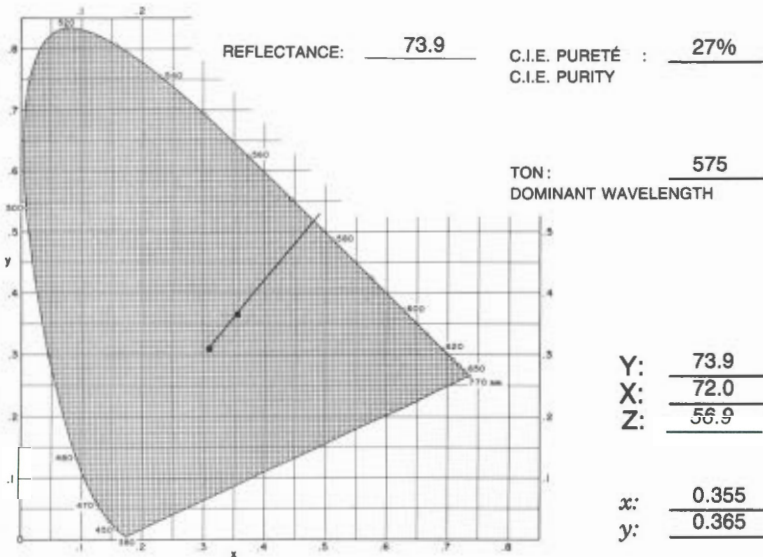

ID. PATCHES BLOCS IDEN.	% SCREEN TRAME	DENSITY DENSITÉ	% PRINT IMPRESSION
A	3	.07	1
B	6	.09	4
C	12	.11	13
D	22	.13	22
E	30	.17	33
F	40	.21	45
G	52	.24	59
H	66	.27	72
I	77	.29	81
J	87	.31	90
M	14	.13	14
N	27	.17	32
O	37	.20	40
P	51	.22	52
SOLID TEINTE PLATE	100	.37	100

PAPER - PAPIER

GRADE / CATÉGORIE: W.S. NEW BRITE

TYPE: UNCOATED - NON COUCHÉ

REFLECTIVITÉ / REFLECTIVITY: 83%

OPACITÉ / OPACITY: 85.5%

% CONTRASTE/CONTRAST: 19%

PLATE - PLAQUE

SUBT. - SOUST.

TYPE: NEGATIVE

PRESS - PRESSE

• MEIHLE

• UNIT(É) #: LOWER/INFÉRIEURE

The colour printed here was blended from, and should only be blended from PANTONE Basic Colours obtained from a PANTONE Licensed Printing Ink Manufacturer. Pantone, Inc. assumes no responsibility for the accuracy of the formulas or the colour reproduced.

La couleur ci-imprimée fut et devrait être mélangée seulement à partir des couleurs de base PANTONE obtenues d'un manufacturier d'encre autorisé. La compagnie Pantone, Inc. n'assume aucune responsabilité quant à l'exactitude du mélange ou de la couleur obtenue.

RDD - DRD

COLOURS AND SCREENS

COULEURS ET TRAMES



BIANGULAR SCREENS — TRAMES BIANGULÉES

M

- .08mm
- .13mm
- .18mm
- .25mm
- .38mm

N

- .08mm
- .13mm
- .18mm
- .25mm
- .38mm

O

- .08mm
- .13mm
- .18mm
- .25mm
- .38mm

P

- .08mm
- .13mm
- .18mm
- .25mm
- .38mm

SOLID — TEINTE PLATE

- 4 pt. Century First/Firstique
- 8 pt. Triumvirate Roman/Romain
- 10 pt. Futura Roman/Romain
- 12 pt. CG Trade Condensed/Condensé

- .08mm
- .13mm
- .18mm
- .25mm
- .38mm

A

B

C

D

E

F

G

H

I

J

S

TECHNICAL INFORMATION — DONNÉES TECHNIQUES

INK - ENCRE

PANTONE® * FORMUL (A/E)

COLOUR No. COULEUR : M-5760-5823

- .1110 parts Pantone Process Yellow
- .0720 parts Pantone Warm Red
- .0340 parts Pantone Mixing Black
- .7830 parts Pantone Extender

AIM SOLID DENSITY
DENSITÉ TEINTE PLATE VISÉE : 0.37 W/H 0.33 D/S

GRAYNESS - NETTETÉ : N/A

HUE ERROR - DÉVIATION DE : N/A
TEINTE

INK EFFICIENCY : N/A
EFFICACITÉ DE L'ENCRE

DENSITOMETRY / DENSITOMÉTRIE

- CHANNEL-SÉLECTION: YELLOW/JAUNE
- FILTER TYPE DE FILTRES: STATUS T
- FACTEUR n FACTOR: 2.7

* Pantone, Inc.'s check-standard trademark for colour reproduction and colour reproduction materials.
* La marque de Pantone, Inc. de contrôle uniforme pour la reproduction en couleur et les matériaux pour la reproduction en couleur.

CIE CHROMATICITY DIAGRAM(ME) DES CHROMATICITÉS CIE

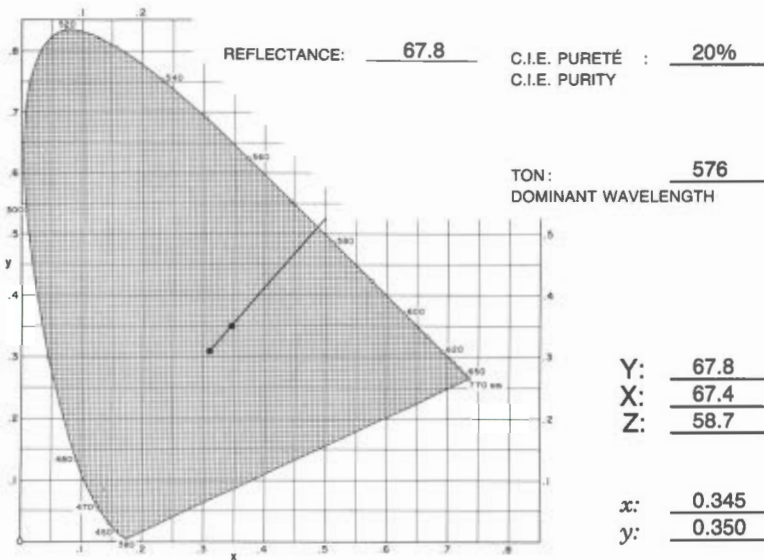

ID. PATCHES BLOCS IDEN.	% SCREEN TRAME	DENSITY DENSITÉ	% PRINT IMPRESSION
A	3	.10	6
B	6	.10	9
C	12	.13	15
D	22	.14	22
E	30	.17	33
F	40	.19	41
G	52	.21	53
H	66	.24	64
I	77	.27	75
J	87	.29	82
M	14	.13	21
N	27	.17	36
O	37	.18	41
P	51	.21	53
SOLID TEINTE PLATE	100	.32	100

PAPER - PAPIER

GRADE / CATÉGORIE: W.S. STANDARD

TYPE: UNCOATED - NON COUCHÉ

REFLECTIVITÉ / REFLECTIVITY: 83%

OPACITÉ / OPACITY: 87%

% CONTRASTE/CONTRAST: 16%

PLATE - PLAQUE

SUBT. - SOUST.

TYPE: NEGATIVE

PRESS - PRESSE

• MEIHLE

• UNIT(É) #: LOWER/INFÉRIEURE

The colour printed here was blended from, and should only be blended from PANTONE Basic Colours obtained from a PANTONE Licensed Printing Ink Manufacturer.
Pantone, Inc. assumes no responsibility for the accuracy of the formulas or the colour reproduced.

La couleur ci-imprimée fut et devrait être mélangée seulement à partir des couleurs de base PANTONE obtenues d'un fabricant d'encre autorisé.
La compagnie Pantone, Inc. n'assume aucune responsabilité quant à l'exactitude du mélange ou de la couleur obtenue.

RDD - DRD

COLOURS AND SCREENS

COULEURS ET TRAMES



BIANGULAR SCREENS — TRAMES BIANGULÉES

M

4 pt. Futura	.08mm	
8 pt. Futura	.13mm	
10 pt. Futura	.18mm	
12 pt. Futura	.25mm	
14 pt. Futura	.38mm	

N

4 pt. Futura	.08mm	
8 pt. Futura	.13mm	
10 pt. Futura	.18mm	
12 pt. Futura	.25mm	
14 pt. Futura	.38mm	

O

4 pt. Futura	.08mm	
8 pt. Futura	.13mm	
10 pt. Futura	.18mm	
12 pt. Futura	.25mm	
14 pt. Futura	.38mm	

P

4 pt. Futura	.08mm	
8 pt. Futura	.13mm	
10 pt. Futura	.18mm	
12 pt. Futura	.25mm	
14 pt. Futura	.38mm	

SOLID — TEINTE PLATE

4 pt. Futura	.08mm	
8 pt. Futura	.13mm	
10 pt. Futura	.18mm	
12 pt. Futura	.25mm	
14 pt. Futura	.38mm	

A

B

C

D

E

F

G

H

I

J

S

TECHNICAL INFORMATION — DONNÉES TECHNIQUES

INK - ENCRE

PANTONE® * FORMUL (A/E)

COLOUR No. COULEUR : M-5760-5823

- .1110 parts Pantone Process Yellow
- .0720 parts Pantone Warm Red
- .0340 parts Pantone Mixing Black
- .7830 parts Pantone Extender

AIM SOLID DENSITY
DENSITÉ TEINTE PLATE VISÉE : 0.35 W/H 0.30 D/S

GRAYNESS - NETTETÉ : N/A

HUE ERROR - DÉVIATION DE : N/A
TEINTE

INK EFFICIENCY : N/A
EFFICACITÉ DE L'ENCRE

DENSITOMETRY / DENSITOMÉTRIE

- CHANNEL-SÉLECTION: YELLOW/JAUNE
- FILTER TYPE DE FILTRES: STATUS T
- FACTEUR n FACTOR: 2.7

* Pantone, Inc.'s check-standard trademark for colour reproduction and colour reproduction materials.
* La marque de Pantone, Inc. de contrôle uniforme pour la reproduction en couleur et les matériaux pour la reproduction en couleur.

CIE CHROMATICITY DIAGRAM(ME) DES CHROMATICITÉS CIE

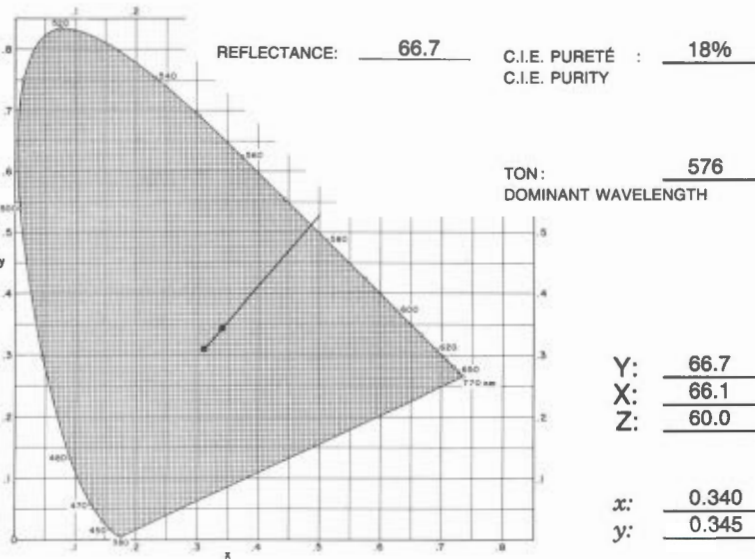

ID. PATCHES BLOCS IDEN.	% SCREEN TRAME	DENSITY DENSITÉ	% PRINT IMPRESSION
A	3	.09	6
B	6	.09	10
C	12	.11	17
D	22	.12	26
E	30	.15	38
F	40	.17	46
G	52	.20	62
H	66	.22	71
I	77	.24	84
J	87	.27	94
M	14	.12	21
N	27	.15	38
O	37	.17	45
P	51	.19	58
SOLID TEINTE PLATE	100	.29	100

PAPER - PAPIER

GRADE / CATÉGORIE: W.S. NEW BRITE

TYPE: UNCOATED - NON COUCHÉ

REFLECTIVITÉ / REFLECTIVITY: 83%

OPACITÉ / OPACITY: 85.5%

% CONTRASTE/CONTRAST: 17%

PLATE - PLAQUE

SUBT. - SOUST.

TYPE: NEGATIVE

PRESS - PRESSE

• MEIHLE

• UNIT(É) #: LOWER/INFÉRIEURE

The colour printed here was blended from, and should only be blended from PANTONE Basic Colours obtained from a PANTONE Licensed Printing Ink Manufacturer.
Pantone, Inc. assumes no responsibility for the accuracy of the formulas or the colour reproduced.

La couleur ci-imprimée fut et devrait être mélangée seulement à partir des couleurs de base PANTONE obtenues d'un manufacturier d'encre autorisé.
La compagnie Pantone, Inc. n'assume aucune responsabilité quant à l'exactitude du mélange ou de la couleur obtenue.

0 1 2 3
8 8 8 8
m m m m

COLOUR NO. 5823
No. DE COULEUR

RDD - DRD

COLOURS AND SCREENS

COULEURS ET TRAMES

.38mm

F

.13mm

BIANGULAR SCREENS — TRAMES BIANGULÉES

M

.08mm
.13mm
.18mm
.25mm
.38mm

N

.08mm
.13mm
.18mm
.25mm
.38mm

O

.08mm
.13mm
.18mm
.25mm
.38mm

P

.08mm
.13mm
.18mm
.25mm
.38mm

SOLID — TEINTE PLATE

4 pt. Times Ten/Deux Douze
8 pt. Times Ten Roman/Romain
10 pt. Futura Roman/Romain
12 pt. CG Trade Condensed/Condensé

.08mm
.13mm
.18mm
.25mm
.38mm

A

B

C

D

E

F

G

H

I

J

S

0 0 0 0
0 0 0 1
8 6 7 0 6

TECHNICAL INFORMATION — DONNÉES TECHNIQUES

INK - ENCRE

PANTONE® * FORMUL (A)
E

COLOUR No. COULEUR : M-5770-5834

- .0550 parts Pantone Orange
- .2080 parts Pantone 012 Yellow
- .3180 parts Pantone Opaque White
- .0030 parts Pantone Mixing Black
- .4160 parts Pantone White

AIM SOLID DENSITY
DENSITÉ TEINTE PLATE VISÉE : 0.60 W/H 0.58 D/S

GRAYNESS - NETTETÉ : N/A

HUE ERROR - DÉVIATION DE : N/A
TEINTE

INK EFFICIENCY : N/A
EFFICACITÉ DE L'ENCRE

DENSITOMETRY / DENSITOMÉTRIE

- CHANNEL-SÉLECTION: YELLOW/JAUNE
- FILTER TYPE DE FILTRES: STATUS T
- FACTEUR n FACTOR: 2.7

* Pantone, Inc.'s check-standard trademark for colour reproduction and colour reproduction materials.

* La marque de Pantone, Inc. de contrôle uniforme pour la reproduction en couleur et les matériaux pour la reproduction en couleur.

CIE CHROMATICITY DIAGRAM(ME) DES CHROMATICITÉS CIE

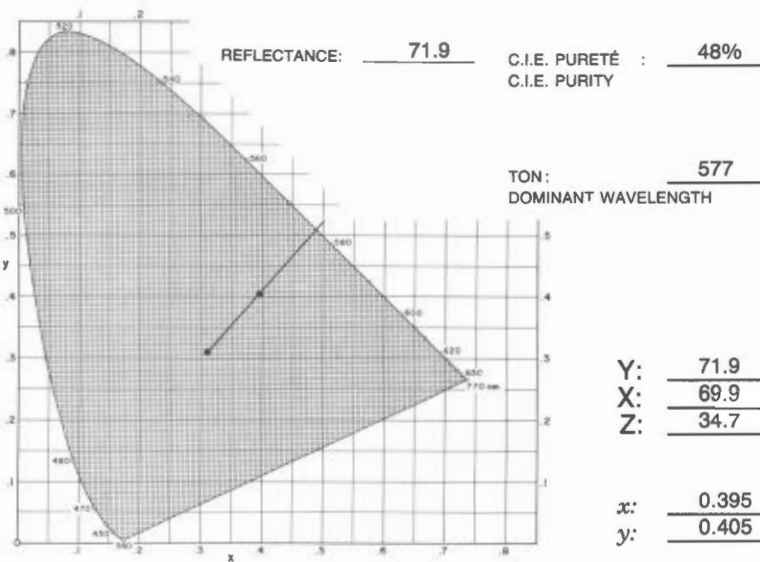

PAPER - PAPIER

GRADE / CATÉGORIE: W.S. STANDARD

TYPE: UNCOATED - NON COUCHÉ

REFLECTIVITÉ / REFLECTIVITY: 81%

OPACITÉ / OPACITY: 87%

% CONTRASTE/CONTRAST: 18%

PLATE - PLAQUE

SUBT. - SOUST.

TYPE: NEGATIVE

PRESS - PRESSE

• MEIHLE

• UNIT(É) #: LOWER/INFÉRIEURE

ID. PATCHES BLOCS IDEN.	% SCREEN FRAME	DENSITY DENSITÉ	% PRINT IMPRESSION
A	3	.11	6
B	6	.12	9
C	12	.15	16
D	22	.19	28
E	30	.23	39
F	40	.28	49
G	52	.34	62
H	66	.40	79
I	77	.44	86
J	87	.48	73
M	14	.17	21
N	27	.24	40
O	37	.28	48
P	51	.33	62
SOLID TEINTE PLATE	100	.54	100

The colour printed here was blended from, and should only be blended from PANTONE Basic Colours obtained from a PANTONE Licensed Printing Ink Manufacturer. Pantone, Inc. assumes no responsibility for the accuracy of the formulas or the colour reproduced.

La couleur ci-imprimée fut et devrait être mélangée seulement à partir des couleurs de base PANTONE obtenues d'un fabricant d'encre autorisé. La compagnie Pantone, Inc. n'assume aucune responsabilité quant à l'exactitude du mélange ou de la couleur obtenue.

RDD - DRD

COLOURS AND SCREENS

COULEURS ET TRAMES

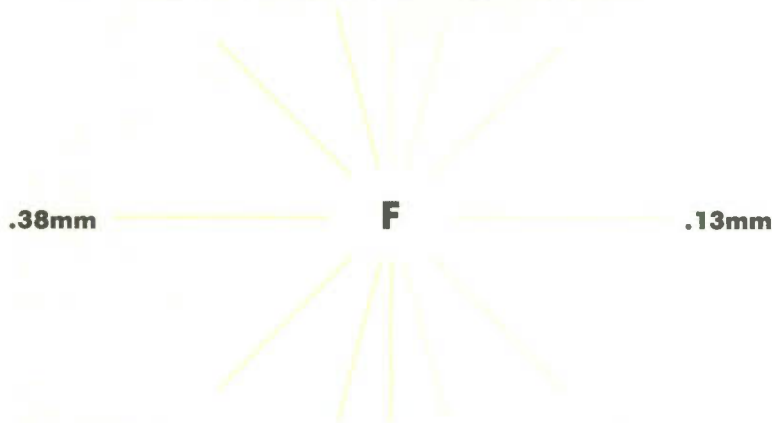

BIANGULAR SCREENS — TRAMES BIANGULÉES

M

12 pt. Century Text Italic/Italique	.08mm	
8 pt. Century Roman/Romain	.13mm	
10 pt. Futura Roman/Romain	.18mm	
12 pt. CG Trade Condensed/Condensé	.25mm	
	.38mm	

N

12 pt. Century Roman/Romain	.08mm	
8 pt. Century Roman/Romain	.13mm	
10 pt. CG Trade Condensed/Condensé	.18mm	
12 pt. Cent. Text Italic/Italique	.25mm	
	.38mm	

O

12 pt. Century Roman/Romain	.08mm	
8 pt. CG Trade Condensed/Condensé	.13mm	
10 pt. Century Text Italic/Italique	.18mm	
12 pt. Trium. Rom./Romain	.25mm	
	.38mm	

P

12 pt. CG Trade Condensed/Condensé	.08mm	
8 pt. Century Text Italic/Italique	.13mm	
10 pt. Triumvirate Roman/Romain	.18mm	
12 pt. Futura Roman/Romain	.25mm	
	.38mm	

SOLID — TEINTE PLATE

12 pt. Century Text Italic/Italique	.08mm	
8 pt. Triumvirate Roman/Romain	.13mm	
10 pt. Futura Roman/Romain	.18mm	
12 pt. CG Trade Condensed/Condensé	.25mm	
	.38mm	

A

B

C

D

E

F

G

H

I

J

S

TECHNICAL INFORMATION — DONNÉES TECHNIQUES

INK - ENCRE

PANTONE® * FORMUL (A)
(E)

COLOUR No. COULEUR : M-5770-5834

- .0550 parts Pantone Orange
- .2080 parts Pantone 012 Yellow
- .3180 parts Pantone Opaque White
- .0030 parts Pantone Mixing Black
- .4160 parts Pantone White

AIM SOLID DENSITY
DENSITÉ TEINTE PLATE VISÉE : 0.58 W/H 0.55 D/S

GRAYNESS - NETTETÉ : N/A

HUE ERROR - DÉVIATION DE : N/A
TEINTE

INK EFFICIENCY : N/A
EFFICACITÉ DE L'ENCRE

DENSITOMETRY / DENSITOMÉTRIE

- CHANNEL-SÉLECTION: YELLOW/JAUNE
- FILTER TYPE DE FILTRES: STATUS T
- FACTEUR n FACTOR: 2.7

* Pantone, Inc.'s check-standard trademark for colour reproduction and colour reproduction materials.
* La marque de Pantone, Inc. de contrôle uniforme pour la reproduction en couleur et les matériaux pour la reproduction en couleur.

CIE CHROMATICITY DIAGRAM(ME) DES CHROMATICITÉS CIE

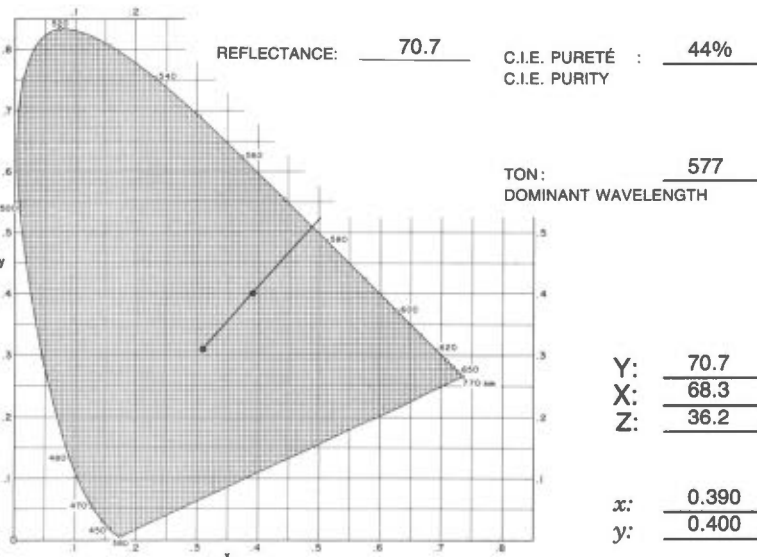

PAPER - PAPIER

GRADE / CATÉGORIE: W.S. NEW BRITE

TYPE: UNCOATED - NON COUCHÉ

REFLECTIVITÉ / REFLECTIVITY: 85%

OPACITÉ / OPACITY: 85.5%

% CONTRASTE/CONTRAST: 14%

PLATE - PLAQUE

SUBT. - SOUST.

TYPE: NEGATIVE

PRESS - PRESSE

• MEIHLE

• UNIT(É) #: LOWER/INFÉRIEURE

ID. PATCHES BLOCS IDEN.	% SCREEN TRAME	DENSITY DENSITÉ	% PRINT IMPRESSION
A	3	.09	6
B	6	.10	9
C	12	.13	16
D	22	.18	27
E	30	.22	37
F	40	.26	50
G	52	.33	63
H	66	.38	75
I	77	.42	84
J	87	.44	91
M	14	.15	23
N	27	.23	39
O	37	.25	49
P	51	.31	61
SOLID TEINTE PLATE	100	.49	100

The colour printed here was blended from, and should only be blended from PANTONE Basic Colours obtained from a PANTONE Licensed Printing Ink Manufacturer.
Pantone, Inc. assumes no responsibility for the accuracy of the formulas or the colour reproduced.

La couleur ci-imprimée fut et devrait être mélangée seulement à partir des couleurs de base PANTONE obtenues d'un manufacturier d'encre autorisé.
La compagnie Pantone, Inc. n'assume aucune responsabilité quant à l'exactitude du mélange ou de la couleur obtenue.

RDD - DRD

COLOURS AND SCREENS

COULEURS ET TRAMES

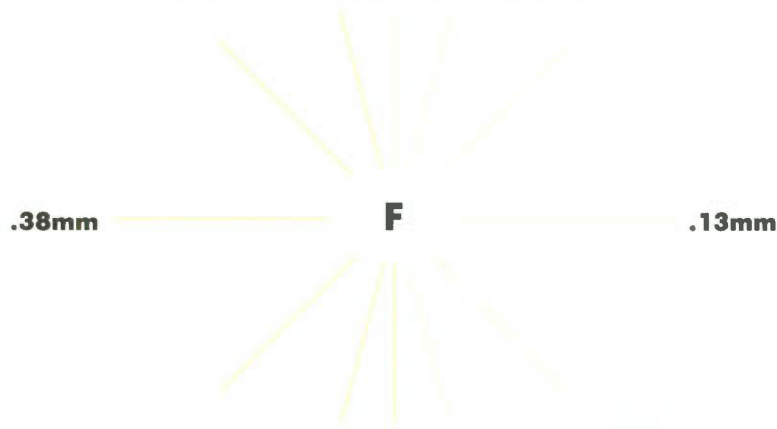

BIANGULAR SCREENS — TRAMES BIANGULÉES

M

1 pt. Century Roman/Romain	.08mm	
4 pt. Century Roman/Romain	.13mm	
10 pt. Century Roman/Romain	.18mm	
12 pt. Century Roman/Romain	.25mm	
18 pt. Century Roman/Romain	.38mm	

N

1 pt. Century Roman/Romain	.08mm	
4 pt. Century Roman/Romain	.13mm	
10 pt. Century Roman/Romain	.18mm	
12 pt. Century Roman/Romain	.25mm	
18 pt. Century Roman/Romain	.38mm	

O

1 pt. Century Roman/Romain	.08mm	
4 pt. Century Roman/Romain	.13mm	
10 pt. Century Roman/Romain	.18mm	
12 pt. Century Roman/Romain	.25mm	
18 pt. Century Roman/Romain	.38mm	

P

1 pt. Century Roman/Romain	.08mm	
4 pt. Century Roman/Romain	.13mm	
10 pt. Century Roman/Romain	.18mm	
12 pt. Century Roman/Romain	.25mm	
18 pt. Century Roman/Romain	.38mm	

SOLID — TEINTE PLATE

4 pt. Century Roman/Romain	.08mm	
8 pt. Century Roman/Romain	.13mm	
10 pt. Century Roman/Romain	.18mm	
12 pt. Century Roman/Romain	.25mm	
18 pt. Century Roman/Romain	.38mm	

A

B

C

D

E

F

G

H

I

J

S

TECHNICAL INFORMATION — DONNÉES TECHNIQUES

INK - ENCRE

PANTONE® * FORMUL (A/E)

COLOUR No. COULEUR : M-5811-137

- .1170 parts Pantone Orange
- .0040 parts Pantone Mixing Black
- .6840 parts Pantone Extender
- .1950 parts Pantone Opaque White

AIM SOLID DENSITY
DENSITÉ TEINTE PLATE VISÉE : - W/H 0.40 D/S

GRAYNESS - NETTETÉ : N/A

HUE ERROR - DÉVIATION DE : N/A
TEINTE

INK EFFICIENCY : N/A
EFFICACITÉ DE L'ENCRE

DENSITOMETRY / DENSITOMÉTRIE

- CHANNEL-SÉLECTION: YELLOW/JAUNE
- FILTER TYPE DE FILTRES: STATUS T
- FACTEUR n FACTOR: 2.7

* Pantone, Inc.'s check-standard trademark for colour reproduction and colour reproduction materials.

* La marque de Pantone, Inc. de contrôle uniforme pour la reproduction en couleur et les matériaux pour la reproduction en couleur.

CIE CHROMATICITY DIAGRAM(ME) DES CHROMATICITÉS CIE

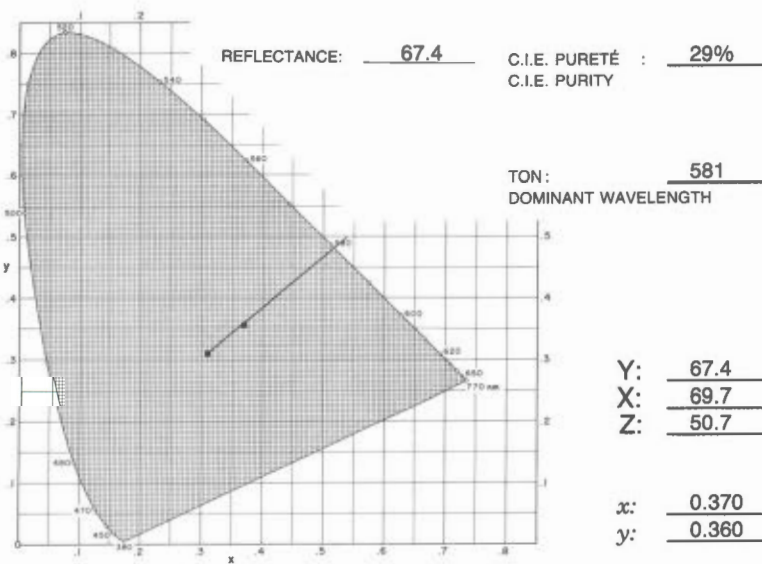

PAPER - PAPIER

GRADE / CATÉGORIE: W.S. STANDARD

TYPE: UNCOATED - NON COUCHÉ

REFLECTIVITÉ / REFLECTIVITY: 79%

OPACITÉ / OPACITY: 87%

% CONTRASTE/CONTRAST: 18%

PLATE - PLAQUE

TYPE: SUBT. - SOUST.

NEGATIVE

PRESS - PRESSE

• MEIHLE

• UNIT(É) #: LOWER/INFÉRIEURE

ID. PATCHES BLOCS IDEN.	% SCREEN TRAME	DENSITY DENSITÉ	% PRINT IMPRESSION
A	3	.10	4
B	6	.11	7
C	12	.13	15
D	22	.16	26
E	30	.19	34
F	40	.22	48
G	52	.27	59
H	66	.30	72
I	77	.32	82
J	87	.35	87
M	14	.14	17
N	27	.19	35
O	37	.21	45
P	51	.26	57
SOLID TEINTE PLATE	100	.38	100

The colour printed here was blended from, and should only be blended from PANTONE Basic Colours obtained from a PANTONE Licensed Printing Ink Manufacturer. Pantone, Inc. assumes no responsibility for the accuracy of the formulas or the colour reproduced.

La couleur ci-imprimée fut et devrait être mélangée seulement à partir des couleurs de base PANTONE obtenues d'un fabricant d'encre autorisé. La compagnie Pantone, Inc. n'assume aucune responsabilité quant à l'exactitude du mélange ou de la couleur obtenue.

RDD - DRD

COLOURS AND SCREENS

COULEURS ET TRAMES

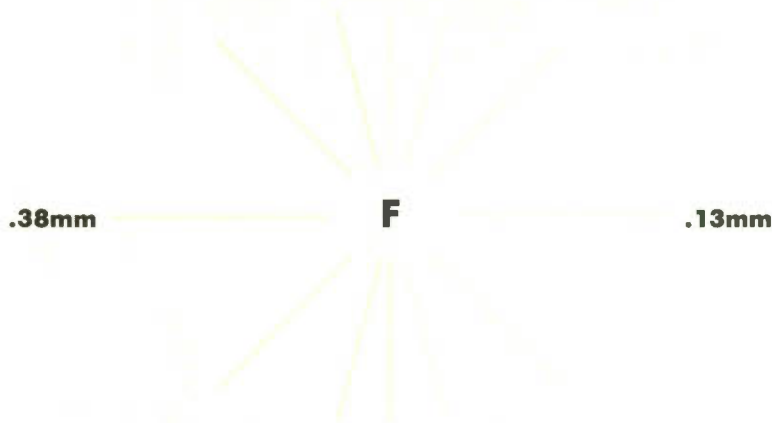

BIANGULAR SCREENS — TRAMES BIANGULÉES

M

4 pt. Century Text/Textuelle	.06mm	
6 pt. Triumvirate Roman/Romain	.13mm	
10 pt. Futura Roman/Romain	.18mm	
12 pt. CG Trade Condensed/Condensé	.25mm	
12 pt. CG Trade Condensed/Condensé	.38mm	

N

4 pt. Century Text/Textuelle	.06mm	
6 pt. Triumvirate Roman/Romain	.13mm	
10 pt. Futura Roman/Romain	.18mm	
12 pt. CG Trade Condensed/Condensé	.25mm	
12 pt. CG Trade Condensed/Condensé	.38mm	

O

4 pt. Century Text/Textuelle	.06mm	
6 pt. Triumvirate Roman/Romain	.13mm	
10 pt. Futura Roman/Romain	.18mm	
12 pt. CG Trade Condensed/Condensé	.25mm	
12 pt. CG Trade Condensed/Condensé	.38mm	

P

4 pt. Century Text/Textuelle	.06mm	
6 pt. Triumvirate Roman/Romain	.13mm	
10 pt. Futura Roman/Romain	.18mm	
12 pt. CG Trade Condensed/Condensé	.25mm	
12 pt. CG Trade Condensed/Condensé	.38mm	

SOLID — TEINTE PLATE

4 pt. Century Text/Textuelle	.06mm	
6 pt. Triumvirate Roman/Romain	.13mm	
10 pt. Futura Roman/Romain	.18mm	
12 pt. CG Trade Condensed/Condensé	.25mm	
12 pt. CG Trade Condensed/Condensé	.38mm	

A

B

C

D

E

F

G

H

I

J

S

TECHNICAL INFORMATION — DONNÉES TECHNIQUES

INK - ENCRE

PANTONE® * FORMUL (A_E)

COLOUR No. COULEUR : M-5811-137

- .1170 parts Pantone Orange
- .0040 parts Pantone Mixing Black
- .6840 parts Pantone Extender
- .1950 parts Pantone Opaque White

AIM SOLID DENSITY
DENSITÉ TEINTE PLATE VISÉE : 0.43 W/H 0.42 D/S

GRAYNESS - NETTETÉ : N/A

HUE ERROR - DÉVIATION DE : N/A
TEINTE

INK EFFICIENCY : N/A
EFFICACITÉ DE L'ENCRE

DENSITOMETRY / DENSITOMÉTRIE

- CHANNEL-SÉLECTION: YELLOW/JAUNE
- FILTER TYPE DE FILTRES: STATUS T
- FACTEUR n FACTOR: 2.7

* Pantone, Inc.'s check-standard trademark for colour reproduction and colour reproduction materials.
* La marque de Pantone, Inc. de contrôle uniforme pour la reproduction en couleur et les matériaux pour la reproduction en couleur.

CIE CHROMATICITY DIAGRAM(ME) DES CHROMATICITÉS CIE

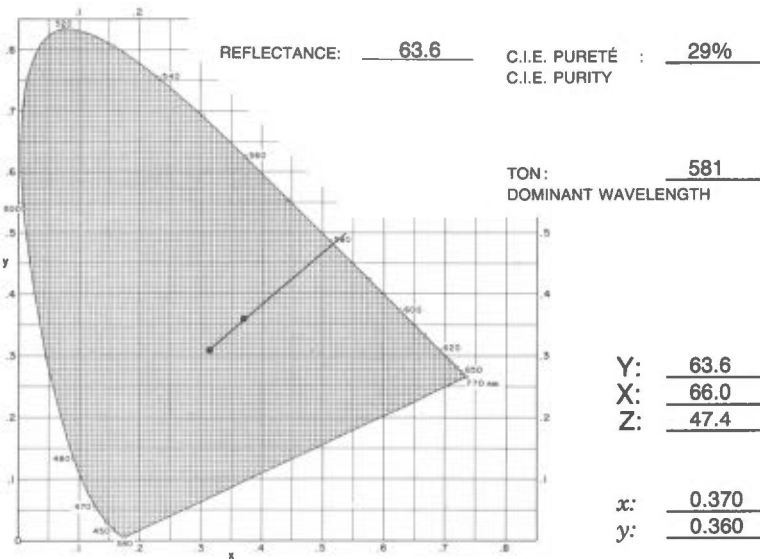

PAPER - PAPIER

GRADE / CATÉGORIE: W.S. NEW BRITE

TYPE: UNCOATED - NON COUCHÉ

REFLECTIVITÉ / REFLECTIVITY: 81%

OPACITÉ / OPACITY: 85.5%

% CONTRASTE/CONTRAST: 18%

PLATE - PLAQUE

SUBT. - SOUST.

TYPE: NEGATIVE

PRESS - PRESSE

• MEIHLE

• UNIT(É) #: LOWER/INFÉRIEURE

ID. PATCHES BLOCS IDEN.	% SCREEN TRAME	DENSITY DENSITÉ	% PRINT IMPRESSION
A	3	.09	4
B	6	.11	6
C	12	.13	12
D	22	.15	22
E	30	.18	33
F	40	.21	44
G	52	.26	59
H	66	.31	71
I	77	.32	80
J	87	.35	88
M	14	.12	16
N	27	.18	33
O	37	.21	43
P	51	.24	55
SOLID TEINTE PLATE	100	.39	100

The colour printed here was blended from, and should only be blended from PANTONE Basic Colours obtained from a PANTONE Licensed Printing Ink Manufacturer.
Pantone, Inc. assumes no responsibility for the accuracy of the formulas or the colour reproduced.

La couleur ci-imprimée fut et devrait être mélangée seulement à partir des couleurs de base PANTONE obtenues d'un fabricant d'encre autorisé.
La compagnie Pantone, Inc. n'assume aucune responsabilité quant à l'exactitude du mélange ou de la couleur obtenue.

RDD - DRD

COLOURS AND SCREENS

COULEURS ET TRAMES

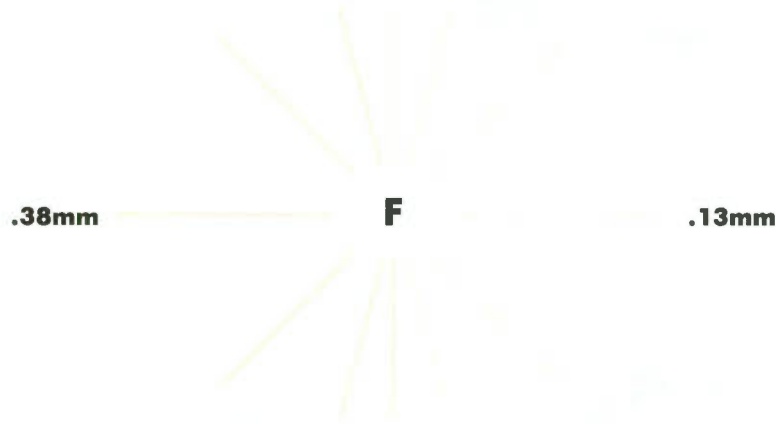

BIANGULAR SCREENS — TRAMES BIANGULÉES

M

.08mm
.13mm
.18mm
.25mm
.38mm

N

.08mm
.13mm
.18mm
.25mm
.38mm

O

.08mm
.13mm
.18mm
.25mm
.38mm

P

.08mm
.13mm
.18mm
.25mm
.38mm

SOLID — TEINTE PLATE

4 pt. Century Text/Ital/Italica
8 pt. Triumvirate Roman/Romain
10 pt. Futura Roman/Romain
12 pt. CG Trade Condensed/Condensé

.08mm
.13mm
.18mm
.25mm
.38mm

A

B

C

D

E

F

G

H

I

J

S

TECHNICAL INFORMATION — DONNÉES TECHNIQUES

INK - ENCRE

PANTONE® * FORMUL (A)
(E)

COLOUR No. COULEUR : M-5812-138

- .0860 parts Pantone Warm Red
- .0210 parts Pantone Process Blue
- .1850 parts Pantone Process Yellow
- .7080 parts Pantone Extender

AIM SOLID DENSITY
DENSITÉ TEINTE PLATE VISÉE : 0.58 W/H 0.56 D/S

GRAYNESS - NETTETÉ : N/A

HUE ERROR - DÉVIATION DE : N/A
TEINTE

INK EFFICIENCY : N/A
EFFICACITÉ DE L'ENCRE

DENSITOMETRY / DENSITOMÉTRIE

- CHANNEL-SÉLECTION: YELLOW/JAUNE
- FILTER TYPE DE FILTRES: STATUS T
- FACTEUR n FACTOR: 2.7

* Pantone, Inc.'s check-standard trademark for colour reproduction and colour reproduction materials.

* La marque de Pantone, Inc. de contrôle uniforme pour la reproduction en couleur et les matériaux pour la reproduction en couleur.

CIE CHROMATICITY DIAGRAM(ME) DES CHROMATICITÉS CIE

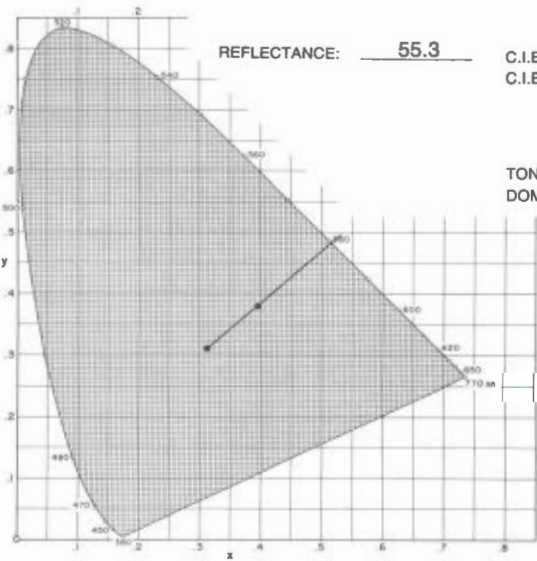

REFLECTANCE: 55.3 C.I.E. PURETÉ : 41%
C.I.E. PURITY

TON: 581
DOMINANT WAVELENGTH

Y: 55.3
X: 58.7
Z: 34.8

x: 0.395
y: 0.380

PAPER - PAPIER

GRADE / CATÉGORIE: W.S. STANDARD

TYPE: UNCOATED - NON COUCHÉ

REFLECTIVITÉ / REFLECTIVITY: 81%

OPACITÉ / OPACITY: 87%

% CONTRASTE/CONTRAST: 19%

PLATE - PLAQUE

SUBT. - SOUST. :

TYPE: NEGATIVE

PRESS - PRESSE

• MEIHLE

• UNIT(É) #: LOWER/INFÉRIEURE

ID. PATCHES BLOCS IDEN.	% SCREEN FRAME	DENSITY DENSITÉ	% PRINT IMPRESSION
A	3	.11	3
B	6	.13	8
C	12	.16	15
D	22	.19	26
E	30	.24	35
F	40	.29	46
G	52	.34	59
H	66	.40	71
I	77	.44	82
J	87	.48	89
M	14	.17	18
N	27	.23	35
O	37	.28	46
P	51	.32	56
SOLID TEINTE PLATE	100	.54	100

The colour printed here was blended from, and should only be blended from PANTONE Basic Colours obtained from a PANTONE Licensed Printing Ink Manufacturer. Pantone, Inc. assumes no responsibility for the accuracy of the formulas or the colour reproduced.

La couleur ci- imprimée fut et devrait être mélangée seulement à partir des couleurs de base PANTONE obtenues d'un fabricant d'encre autorisé. La compagnie Pantone, Inc. n'assume aucune responsabilité quant à l'exactitude du mélange ou de la couleur obtenue.

RDD - DRD

COLOURS AND SCREENS

COULEURS ET TRAMES

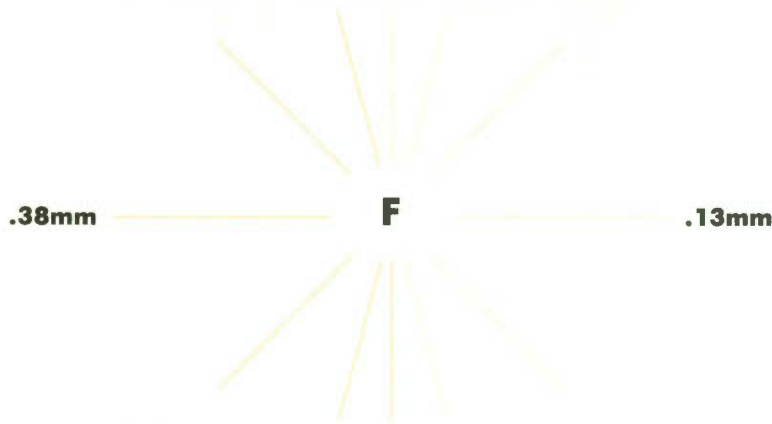

BIANGULAR SCREENS — TRAMES BIANGULÉES

M

4 pt. Century Text Italic/Italique	.08mm	
6 pt. Century Text Italic/Italique	.13mm	
10 pt. Futura Roman/Romain	.18mm	
12 pt. CG Trade Condensed/Condensé	.25mm	
	.38mm	

N

4 pt. Century Text Italic/Italique	.08mm	
6 pt. Century Text Italic/Italique	.13mm	
10 pt. CG Trade Condensed/Condensé	.18mm	
12 pt. Century Text Italic/Italique	.25mm	
	.38mm	

O

4 pt. Century Text Italic/Italique	.08mm	
6 pt. CG Trade Condensed/Condensé	.13mm	
10 pt. Century Text Italic/Italique	.18mm	
12 pt. Trium. Rom./Romain	.25mm	
	.38mm	

P

4 pt. CG Trade Condensed/Condensé	.08mm	
6 pt. Century Text Italic/Italique	.13mm	
10 pt. Triumvirate Roman/Romain	.18mm	
12 pt. Futura Roman/Romain	.25mm	
	.38mm	

SOLID — TEINTE PLATE

4 pt. Century Text Italic/Italique	.08mm	
6 pt. Triumvirate Roman/Romain	.13mm	
10 pt. Futura Roman/Romain	.18mm	
12 pt. CG Trade Condensed/Condensé	.25mm	
	.38mm	

A

B

C

D

E

F

G

H

I

J

S

TECHNICAL INFORMATION — DONNÉES TECHNIQUES

INK - ENCRE

PANTONE® * FORMUL (A)
(E)

COLOUR No. COULEUR : M-5812-138

- .0860 parts Pantone Warm Red
- .0210 parts Pantone Process Blue
- .1850 parts Pantone Process Yellow
- .7080 parts Pantone Extender

AIM SOLID DENSITY
DENSITÉ TEINTE PLATE VISÉE : 0.58 W/H 0.54 D/S

GRAYNESS - NETTÉTÉ : N/A

HUE ERROR - DÉVIATION DE : N/A
TEINTE

INK EFFICIENCY
EFFICACITÉ DE L'ENCRE : N/A

DENSITOMETRY / DENSITOMÉTRIE

- CHANNEL-SÉLECTION: YELLOW/JAUNE
- FILTER TYPE DE FILTRES: STATUS T
- FACTEUR n FACTOR: 2.7

* Pantone, Inc.'s check-standard trademark for colour reproduction and colour reproduction materials.
* La marque de Pantone, Inc. de contrôle uniforme pour la reproduction en couleur et les matériaux pour la reproduction en couleur.

CIE CHROMATICITY DIAGRAM(ME) DES CHROMATICITÉS CIE

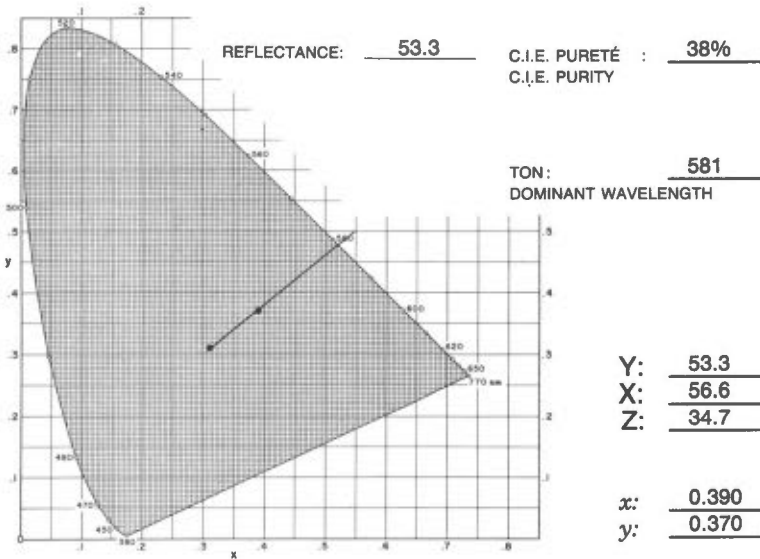

ID. PATCHES BLOCS IDEN.	% SCREEN TRAME	DENSITY DENSITE	% PRINT IMPRESSION
A	3	.09	5
B	6	.11	7
C	12	.14	16
D	22	.18	24
E	30	.22	35
F	40	.27	45
G	52	.33	61
H	66	.40	72
I	77	.43	82
J	87	.46	91
M	14	.15	18
N	27	.22	34
O	37	.26	45
P	51	.31	57
SOLID TEINTE PLATE	100	.52	100

PAPER - PAPIER

GRADE / CATÉGORIE: W.S. NEW BRITE

TYPE: UNCOATED - NON COUCHÉ

REFLECTIVITÉ / REFLECTIVITY: 83%

OPACITÉ / OPACITY: 85.5%

% CONTRASTE/CONTRAST: 17%

PLATE - PLAQUE

SUBT. - SOUST.

TYPE: NEGATIVE

PRESS - PRESSE

• MEIHLE

• UNIT(É) #: LOWER/INFÉRIEURE

The colour printed here was blended from, and should only be blended from PANTONE Basic Colours obtained from a PANTONE Licensed Printing Ink Manufacturer. Pantone, Inc. assumes no responsibility for the accuracy of the formulas or the colour reproduced.

La couleur ci-imprimée fut et devrait être mélangée seulement à partir des couleurs de base PANTONE obtenues d'un fabricant d'encre autorisé. La compagnie Pantone, Inc. n'assume aucune responsabilité quant à l'exactitude du mélange ou de la couleur obtenue.

RDD - DRD

COLOURS AND SCREENS

COULEURS ET TRAMES



BIANGULAR SCREENS — TRAMES BIANGULÉES

M

12 pt. Century Text Italic/Italique	.08mm	
10 pt. Futura Roman/Romain	.15mm	
10 pt. CG Trade Condensed/Condensé	.18mm	
10 pt. Futura Roman/Romain	.25mm	
10 pt. Futura Roman/Romain	.38mm	

N

12 pt. Century Text Italic/Italique	.08mm	
10 pt. Futura Roman/Romain	.15mm	
10 pt. CG Trade Condensed/Condensé	.18mm	
12 pt. Cent. Text Italic/Italique	.25mm	
12 pt. Cent. Text Italic/Italique	.38mm	

O

10 pt. Futura Roman/Romain	.08mm	
8 pt. CG Trade Condensed/Condensé	.15mm	
10 pt. Century Text Italic/Italique	.18mm	
12 pt. Trium. Rom./Romain	.25mm	
12 pt. Trium. Rom./Romain	.38mm	

P

12 pt. CG Trade Condensed/Condensé	.08mm	
8 pt. Century Text Italic/Italique	.15mm	
10 pt. Triumvirate Roman/Romain	.18mm	
12 pt. Triumvirate Roman/Romain	.25mm	
12 pt. Futura Roman/Romain	.38mm	

SOLID — TEINTE PLATE

8 pt. Century Text Italic/Italique	.08mm	
8 pt. Triumvirate Roman/Romain	.15mm	
10 pt. Futura Roman/Romain	.18mm	
12 pt. CG Trade Condensed/Condensé	.25mm	
12 pt. CG Trade Condensed/Condensé	.38mm	

A

B

C

D

E

F

G

H

I

J

S

TECHNICAL INFORMATION — DONNÉES TECHNIQUES

INK - ENCRE

PANTONE® * FORMUL (A_E)

COLOUR No. COULEUR : M-5831-131

- .1970 parts Pantone Process Yellow
- .1060 parts Pantone Red
- .0280 parts Pantone Mixing Black
- .6690 parts Pantone Extender

AIM SOLID DENSITY
DENSITÉ TEINTE PLATE VISÉE : 0.87 W/H 0.76 D/S

GRAYNESS - NETTETÉ : N/A

HUE ERROR - DÉVIATION DE : N/A
TEINTE

INK EFFICIENCY : N/A
EFFICACITÉ DE L'ENCRE

DENSITOMETRY / DENSITOMÉTRIE

- CHANNEL-SÉLECTION: YELLOW/JAUNE
- FILTER TYPE DE FILTRES: STATUS T
- FACTEUR n FACTOR: 2.7

* Pantone, Inc.'s check-standard trademark for colour reproduction and colour reproduction materials.
* La marque de Pantone, Inc. de contrôle uniforme pour la reproduction en couleur et les matériaux pour la reproduction en couleur.

CIE CHROMATICITY DIAGRAM(ME) DES CHROMATICITÉS CIE

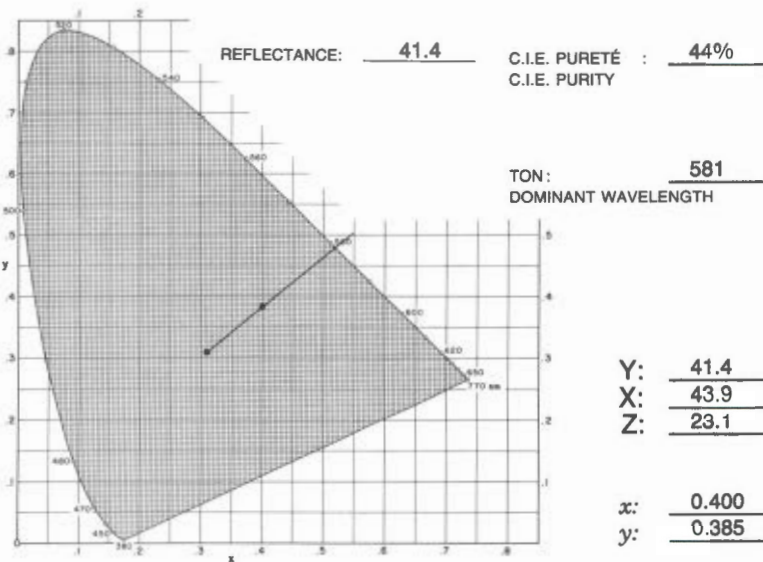

ID. PATCHES BLOCS IDEN.	% SCREEN TRAME	DENSITY DENSITÉ	% PRINT IMPRESSION
A	3	.11	5
B	6	.14	8
C	12	.18	17
D	22	.22	25
E	30	.31	37
F	40	.38	47
G	52	.50	65
H	66	.64	84
I	77	.70	90
J	87	.76	95
M	14	.21	21
N	27	.30	38
O	37	.39	49
P	51	.47	62
SOLID TEINTE PLATE	100	.79	100

PAPER - PAPIER

GRADE / CATÉGORIE: W.S. STANDARD

TYPE: UNCOATED - NON COUCHÉ

REFLECTIVITÉ / REFLECTIVITY: 83%

OPACITÉ / OPACITY: 87%

% CONTRASTE/CONTRAST: 11%

PLATE - PLAQUE

SUBT. - SOUST.

TYPE: NEGATIVE

PRESS - PRESSE

• MEIHLE

• UNIT(É) #: LOWER/INFÉRIEURE

The colour printed here was blended from, and should only be blended from PANTONE Basic Colours obtained from a PANTONE Licensed Printing Ink Manufacturer.
Pantone, Inc. assumes no responsibility for the accuracy of the formulas or the colour reproduced.

La couleur ci-imprimée fut et devrait être mélangée seulement à partir des couleurs de base PANTONE obtenues d'un fabricant d'encre autorisé.
La compagnie Pantone, Inc. n'assume aucune responsabilité quant à l'exactitude du mélange ou de la couleur obtenue.

RDD - DRD

COLOURS AND SCREENS

COULEURS ET TRAMES

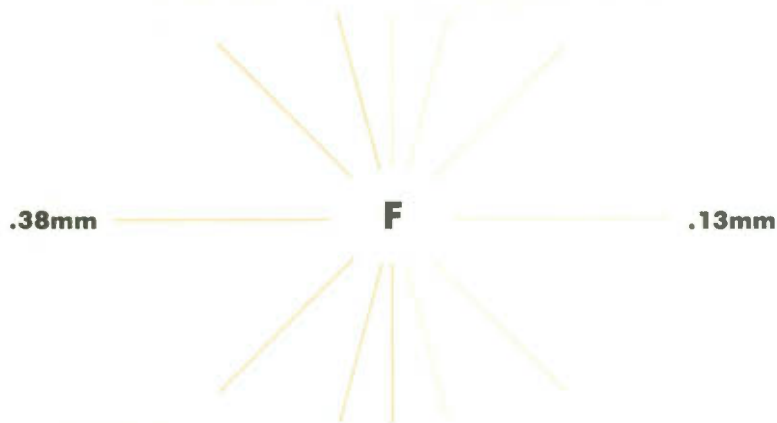

BIANGULAR SCREENS — TRAMES BIANGULÉES

M

6 pt. Futura Roman/Romain	.08mm	
8 pt. Triumvirate Roman/Romain	.13mm	
10 pt. Futura Roman/Romain	.18mm	
12 pt. CG Trade Condensed/Condensé	.25mm	
	.38mm	

N

6 pt. Triumvirate Roman/Romain	.08mm	
8 pt. Futura Roman/Romain	.13mm	
10 pt. CG Trade Condensed/Condensé	.18mm	
12 pt. Cent. Text It/Italique	.25mm	
	.38mm	

O

6 pt. Futura Roman/Romain	.08mm	
8 pt. CG Trade Condensed/Condensé	.13mm	
10 pt. Century Text Italic/Italique	.18mm	
12 pt. Trium. Rom./Romain	.25mm	
	.38mm	

P

6 pt. CG Trade Condensed/Condensé	.08mm	
8 pt. Century Text Italic/Italique	.13mm	
10 pt. Triumvirate Roman/Romain	.18mm	
12 pt. Futura Roman/Romain	.25mm	
	.38mm	

SOLID — TEINTE PLATE

6 pt. Century Text Italic/Italique	.08mm	
8 pt. Triumvirate Roman/Romain	.13mm	
10 pt. Futura Roman/Romain	.18mm	
12 pt. CG Trade Condensed/Condensé	.25mm	
	.38mm	

A

B

C

D

E

F

G

H

I

J

S

TECHNICAL INFORMATION — DONNÉES TECHNIQUES

INK - ENCRE

PANTONE® * FORMUL (A/E)

- .1970 parts Pantone Process Yellow
- .1060 parts Pantone Red
- .0280 parts Pantone Mixing Black
- .6690 parts Pantone Extender

COLOUR No. COULEUR : M-5831-131

AIM SOLID DENSITY
DENSITÉ TEINTE PLATE VISÉE : 0.86 W/H 0.81 D/S

GRAYNESS - NETTETÉ : N/A

HUE ERROR - DÉVIATION DE : N/A
TEINTE

INK EFFICIENCY : N/A
EFFICACITÉ DE L'ENCRE

DENSITOMETRY / DENSITOMÉTRIE

- CHANNEL-SÉLECTION: YELLOW/JAUNE
- FILTER TYPE DE FILTRES: STATUS T
- FACTEUR n FACTOR: 2.7

* Pantone, Inc.'s check-standard trademark for colour reproduction and colour reproduction materials.
* La marque de Pantone, Inc. de contrôle uniforme pour la reproduction en couleur et les matériaux pour la reproduction en couleur.

CIE CHROMATICITY DIAGRAM(ME) DES CHROMATICITÉS CIE

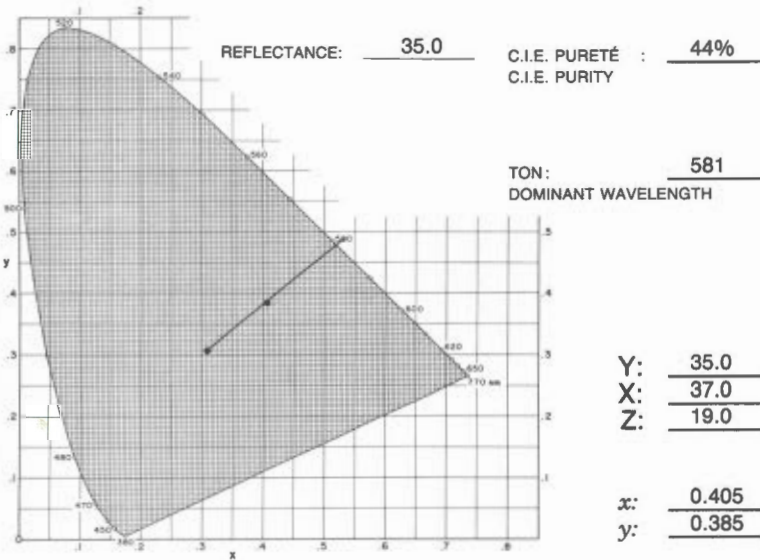

ID. PATCHES BLOCS IDEN.	% SCREEN TRAME	DENSITY DENSITÉ	% PRINT IMPRESSION
A	3	.10	6
B	6	.13	11
C	12	.18	16
D	22	.23	29
E	30	.31	39
F	40	.39	51
G	52	.50	70
H	66	.63	88
I	77	.68	94
J	87	.72	95
M	14	.21	26
N	27	.31	41
O	37	.36	50
P	51	.46	65
SOLID TEINTE PLATE	100	.77	100

PAPER - PAPIER

GRADE / CATÉGORIE: W.S. NEW BRITE

TYPE: UNCOATED - NON COUCHÉ

REFLECTIVITÉ / REFLECTIVITY: 85%

OPACITÉ / OPACITY: 85.5%

% CONTRASTE/CONTRAST: 12%

PLATE - PLAQUE

SUBT. - SOUST.

TYPE: NEGATIVE

PRESS - PRESSE

• MEIHLE

• UNIT(É) #: LOWER/INFÉRIEURE

The colour printed here was blended from, and should only be blended from PANTONE Basic Colours obtained from a PANTONE Licensed Printing Ink Manufacturer.
Pantone, Inc. assumes no responsibility for the accuracy of the formulas or the colour reproduced.

La couleur ci-imprimée fut et devrait être mélangée seulement à partir des couleurs de base PANTONE obtenues d'un fabricant d'encre autorisé.
La compagnie Pantone, Inc. n'assume aucune responsabilité quant à l'exactitude du mélange ou de la couleur obtenue.

RDD - DRD

COLOURS AND SCREENS

COULEURS ET TRAMES

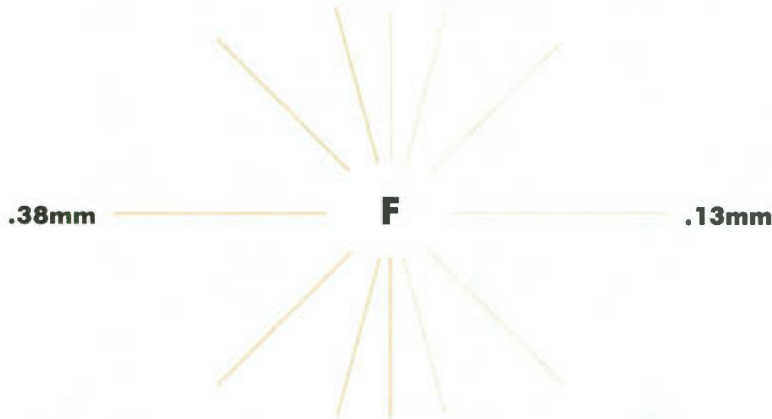

BIANGULAR SCREENS — TRAMES BIANGULÉES

M

5 pt. <i>Triumvirate Roman/Romain</i>	.08mm	
8 pt. <i>Triumvirate Roman/Romain</i>	.13mm	
10 pt. <i>Futura Roman/Romain</i>	.18mm	
12 pt. <i>CG Trade Condensed/Condensé</i>	.25mm	
	.38mm	

N

8 pt. <i>Triumvirate Roman/Romain</i>	.08mm	
8 pt. <i>Futura Roman/Romain</i>	.13mm	
10 pt. <i>CG Trade Condensed/Condensé</i>	.18mm	
12 pt. <i>Cent. Text It./Italique</i>	.25mm	
	.38mm	

O

8 pt. <i>Futura Roman/Romain</i>	.08mm	
8 pt. <i>CG Trade Condensed/Condensé</i>	.13mm	
10 pt. <i>Cent. Text It./Italique</i>	.18mm	
12 pt. <i>Trium. Rom./Romain</i>	.25mm	
	.38mm	

P

8 pt. <i>CG Trade Condensed/Condensé</i>	.08mm	
8 pt. <i>Century Text Italic/Italique</i>	.13mm	
10 pt. <i>Triumvirate Roman/Romain</i>	.18mm	
12 pt. <i>Futura Roman/Romain</i>	.25mm	
	.38mm	

SOLID — TEINTE PLATE

6 pt. <i>Century Text Italic/Italique</i>	.08mm	
8 pt. <i>Triumvirate Roman/Romain</i>	.13mm	
10 pt. <i>Futura Roman/Romain</i>	.18mm	
12 pt. <i>CG Trade Condensed/Condensé</i>	.25mm	
	.38mm	

A

B

C

D

E

F

G

H

I

J

S

TECHNICAL INFORMATION — DONNÉES TECHNIQUES

INK - ENCRE

PANTONE® * FORMUL (A/E)

COLOUR No. COULEUR : M-5831-131

- .1970 parts Pantone Process Yellow
- .1060 parts Pantone Red
- .0280 parts Pantone Mixing Black
- .6690 parts Pantone Extender

AIM SOLID DENSITY
DENSITÉ TEINTE PLATE VISÉE : 0.85 W/H 0.79 D/S

GRAYNESS - NETTETÉ : N/A

HUE ERROR - DÉVIATION DE : N/A
TEINTE

INK EFFICIENCY : N/A
EFFICACITÉ DE L'ENCRE

DENSITOMETRY / DENSITOMÉTRIE

- CHANNEL-SÉLECTION: YELLOW/JAUNE
- FILTER TYPE DE FILTRES: STATUS T
- FACTEUR n FACTOR: 2.7

* Pantone, Inc.'s check-standard trademark for colour reproduction and colour reproduction materials.

* La marque de Pantone, Inc. de contrôle uniforme pour la reproduction en couleur et les matériaux pour la reproduction en couleur.

CIE CHROMATICITY DIAGRAM(ME) DES CHROMATICITÉS CIE

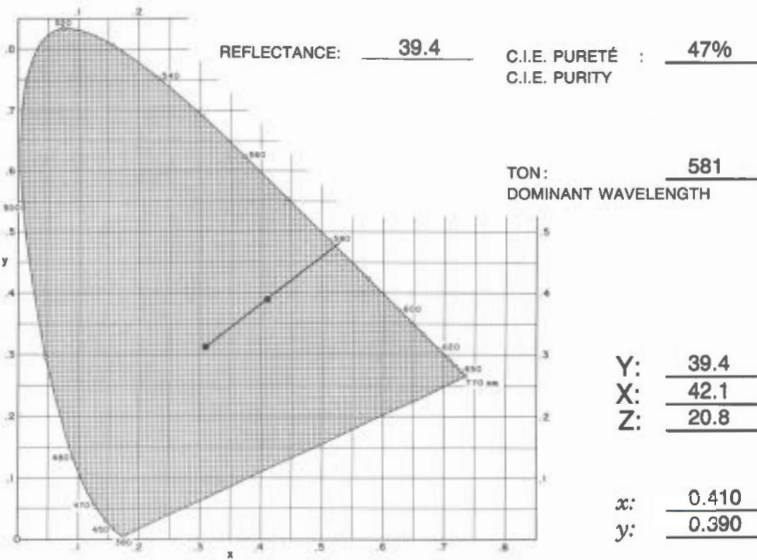

ID. PATCHES BLOCS IDEN.	% SCREEN TRAME	DENSITY DENSITÉ	% PRINT IMPRESSION
A	3	.11	6
B	6	.13	11
C	12	.16	17
D	22	.21	28
E	30	.26	34
F	40	.33	46
G	52	.44	66
H	66	.54	80
I	77	.62	87
J	87	.66	95
M	14	.19	22
N	27	.28	39
O	37	.33	47
P	51	.42	60
SOLID TEINTE PLATE	100	.72	100

PAPER - PAPIER

GRADE / CATÉGORIE: CHART

TYPE: UNCOATED - NON COUCHÉ

REFLECTIVITÉ / REFLECTIVITY: 81%

OPACITÉ / OPACITY: 96.5%

% CONTRASTE/CONTRAST: 14%

PLATE - PLAQUE

SUBT. - SOUST.

TYPE: NEGATIVE

PRESS - PRESSE

• MEIHLE

• UNIT(É) #: LOWER/INFÉRIEURE

The colour printed here was blended from, and should only be blended from PANTONE Basic Colours obtained from a PANTONE Licensed Printing Ink Manufacturer. Pantone, Inc. assumes no responsibility for the accuracy of the formulas or the colour reproduced.

La couleur ci-imprimée fut et devrait être mélangée seulement à partir des couleurs de base PANTONE obtenues d'un fabricant d'encre autorisé. La compagnie Pantone, Inc. n'assume aucune responsabilité quant à l'exactitude du mélange ou de la couleur obtenue.

SURVEYS AND MAPPING BRANCH
DIRECTION DES LEVÉS ET DE LA CARTOGRAPHIE

AVRIL 1987
APRIL

TECHNICAL INFORMATION — DONNÉES TECHNIQUES

INK - ENCRE

PANTONE® * FORMUL (A_E)

COLOUR No. COULEUR : M-5831-139

- .1090 parts Pantone Process Yellow
- .0770 parts Pantone Warm Red
- .0070 parts Pantone Mixing Black
- .1550 parts Pantone Opaque White
- .6520 parts Pantone Extender

AIM SOLID DENSITY
DENSITÉ TEINTE PLATE VISÉE: 0.44 W/H 0.41 D/S

GRAYNESS - NETTETÉ : N/A

HUE ERROR - DÉVIATION DE : N/A
TEINTE

INK EFFICIENCY : N/A
EFFICACITÉ DE L'ENCRE

DENSITOMETRY / DENSITOMÉTRIE

• CHANNEL-SÉLECTION: YELLOW/JAUNE

• FILTER TYPE DE FILTRES: STATUS T

• FACTEUR n FACTOR: 2.7

* Pantone, Inc.'s check-standard trademark for colour reproduction and colour reproduction materials.
* La marque de Pantone, Inc. de contrôle uniforme pour la reproduction en couleur et les matériaux pour la reproduction en couleur.

CIE CHROMATICITY DIAGRAM(ME) DES CHROMATICITÉS CIE

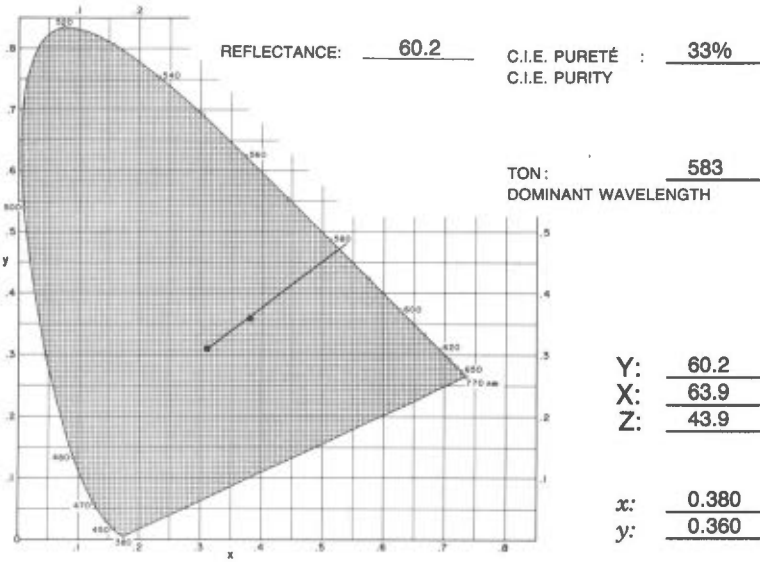

ID. PATCHES BLOCS IDEN.	% SCREEN FRAME	DENSITY DENSITÉ	% PRINT IMPRESSION
A	3	.10	2
B	6	.11	5
C	12	.13	13
D	22	.17	22
E	30	.19	30
F	40	.23	41
G	52	.28	55
H	66	.32	67
I	77	.36	79
J	87	.40	87
M	14	.14	15
N	27	.20	33
O	37	.22	42
P	51	.26	52
SOLID TEINTE PLATE	100	.43	100

PAPER - PAPIER

GRADE / CATÉGORIE: W.S. STANDARD

TYPE: UNCOATED - NON COUCHÉ

REFLECTIVITÉ / REFLECTIVITY: 81%

OPACITÉ / OPACITY: 87%

% CONTRASTE/CONTRAST: 14%

PLATE - PLAQUE

SUBT. - SOUST.

TYPE: NEGATIVE

PRESS - PRESSE

• MEIHLE

• UNIT(É) #: LOWER/INFÉRIEURE

The colour printed here was blended from, and should only be blended from PANTONE Basic Colours obtained from a PANTONE Licensed Printing Ink Manufacturer.
Pantone, Inc. assumes no responsibility for the accuracy of the formulas or the colour reproduced.

La couleur ci-imprimée fut et devrait être mélangée seulement à partir des couleurs de base PANTONE obtenues d'un fabricant d'encre autorisé.
La compagnie Pantone, Inc. n'assume aucune responsabilité quant à l'exactitude du mélange ou de la couleur obtenue.

RDD - DRD

COLOURS AND SCREENS

COULEURS ET TRAMES

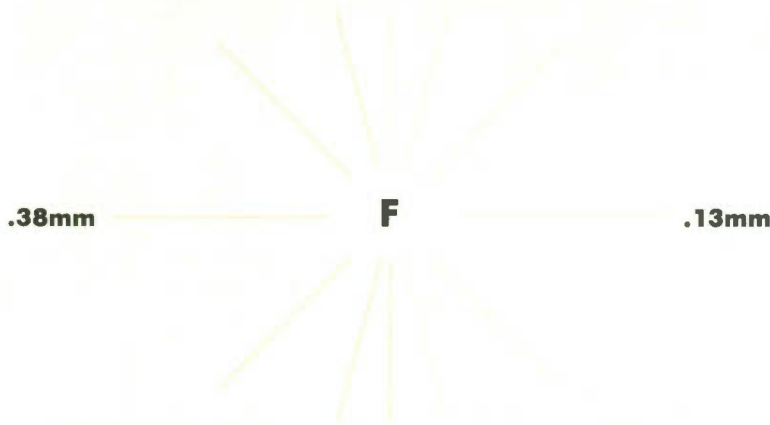

BIANGULAR SCREENS — TRAMES BIANGULÉES

M

4 pt. Century Text/Text	.08mm	
6 pt. Century Text/Text	.13mm	
8 pt. Century Text/Text	.18mm	
10 pt. Century Text/Text	.25mm	
12 pt. Century Text/Text	.38mm	

N

4 pt. Century Text/Text	.08mm	
6 pt. Century Text/Text	.13mm	
8 pt. Century Text/Text	.18mm	
10 pt. Century Text/Text	.25mm	
12 pt. Century Text/Text	.38mm	

O

4 pt. Century Text/Text	.08mm	
6 pt. Century Text/Text	.13mm	
8 pt. Century Text/Text	.18mm	
10 pt. Century Text/Text	.25mm	
12 pt. Century Text/Text	.38mm	

P

4 pt. Century Text/Text	.08mm	
6 pt. Century Text/Text	.13mm	
8 pt. Century Text/Text	.18mm	
10 pt. Century Text/Text	.25mm	
12 pt. Century Text/Text	.38mm	

SOLID — TEINTE PLATE

4 pt. Century Text/Text	.08mm	
6 pt. Century Text/Text	.13mm	
8 pt. Century Text/Text	.18mm	
10 pt. Century Text/Text	.25mm	
12 pt. Century Text/Text	.38mm	

A
B
C
D
E
F
G
H
I
J
S



TECHNICAL INFORMATION — DONNÉES TECHNIQUES

INK - ENCRE

PANTONE® * FORMUL (A)
(E)

COLOUR No. COULEUR : M-5831-139

- .1090 parts Pantone Process Yellow
- .0770 parts Pantone Warm Red
- .0070 parts Pantone Mixing Black
- .1550 parts Pantone Opaque White
- .6520 parts Pantone Extender

AIM SOLID DENSITY
DENSITÉ TEINTE PLATE VISÉE : 0.45 W/H 0.43 D/S

GRAYNESS - NETTETÉ : N/A

HUE ERROR - DÉVIATION DE : N/A
TEINTE

INK EFFICIENCY : N/A
EFFICACITÉ DE L'ENCRE

DENSITOMETRY / DENSITOMÉTRIE

- CHANNEL-SÉLECTION: YELLOW/JAUNE
- FILTER TYPE DE FILTRES: STATUS T
- FACTEUR n FACTOR: 2.7

* Pantone, Inc.'s check-standard trademark for colour reproduction and colour reproduction materials.

* La marque de Pantone, Inc. de contrôle uniforme pour la reproduction en couleur et les matériaux pour la reproduction en couleur.

CIE CHROMATICITY DIAGRAM(ME) DES CHROMATICITÉS CIE

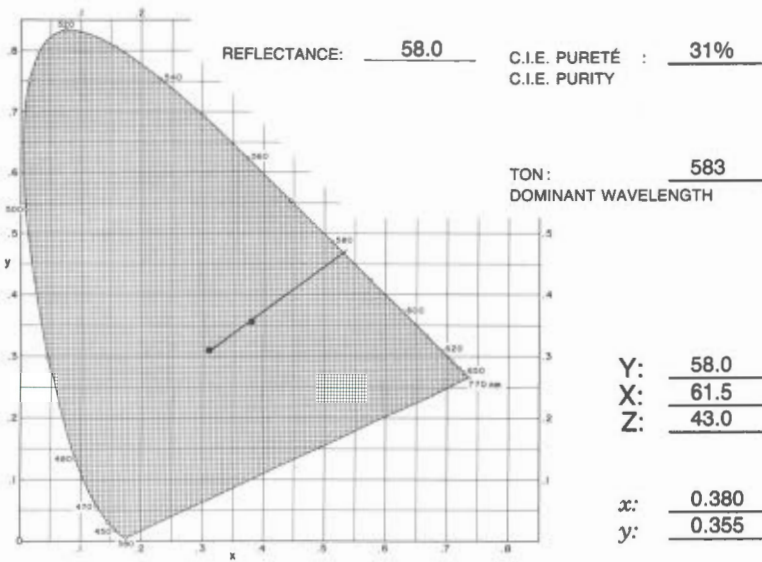

ID. PATCHES BLOCS IDEN.	% SCREEN TRAME	DENSITY DENSITÉ	% PRINT IMPRESSION
A	3	.09	2
B	6	.10	7
C	12	.12	13
D	22	.16	23
E	30	.19	33
F	40	.22	48
G	52	.26	59
H	66	.31	73
I	77	.35	83
J	87	.37	90
M	14	.14	16
N	27	.18	34
O	37	.21	43
P	51	.27	54
SOLID TEINTE PLATE	100	.43	100

PAPER - PAPIER

GRADE / CATÉGORIE: W.S. NEW BRITE

TYPE: UNCOATED - NON COUCHÉ

REFLECTIVITÉ / REFLECTIVITY: 81%

OPACITÉ / OPACITY: 85.5%

% CONTRASTE/CONTRAST: 14%

PLATE - PLAQUE

SUBT. - SOUST.

TYPE: NEGATIVE

PRESS - PRESSE

• MEIHLE

• UNIT(É) #: LOWER/INFÉRIEURE

The colour printed here was blended from, and should only be blended from PANTONE Basic Colours obtained from a PANTONE Licensed Printing Ink Manufacturer. Pantone, Inc. assumes no responsibility for the accuracy of the formulas or the colour reproduced.

La couleur ci-imprimée fut et devrait être mélangée seulement à partir des couleurs de base PANTONE obtenues d'un fabricant d'encre autorisé. La compagnie Pantone, Inc. n'assume aucune responsabilité quant à l'exactitude du mélange ou de la couleur obtenue.

RDD - DRD

COLOURS AND SCREENS

COULEURS ET TRAMES

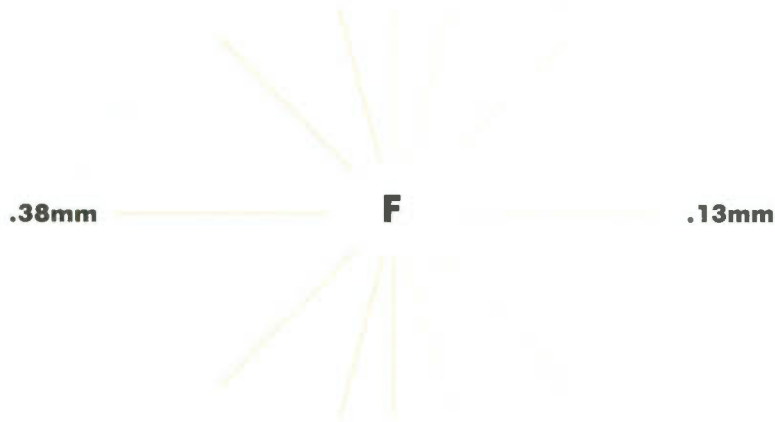

BIANGULAR SCREENS — TRAMES BIANGULÉES

M

- .08mm
- .13mm
- .18mm
- .25mm
- .38mm

N

- .08mm
- .13mm
- .18mm
- .25mm
- .38mm

O

- .08mm
- .13mm
- .18mm
- .25mm
- .38mm

P

- .08mm
- .13mm
- .18mm
- .25mm
- .38mm

SOLID — TEINTE PLATE

- 6 pt. Century Text Italic/Italique
- 8 pt. Triumvirate Roman/Romain
- 10 pt. Futura Roman/Romain
- 12 pt. CG Trade Condensed/Condensé

- .08mm
- .13mm
- .18mm
- .25mm
- .38mm

A

B

C

D

E

F

G

H

I

J

S

TECHNICAL INFORMATION — DONNÉES TECHNIQUES

INK - ENCRE

PANTONE® * FORMUL (A/E)

COLOUR No. COULEUR : M-5832-464

- .2920 parts Pantone Rubine Red
- .1180 parts Pantone Process Blue
- .5340 parts Pantone Process Yellow
- .0560 parts Pantone Mixing Black

AIM SOLID DENSITY
DENSITÉ TEINTE PLATE VISÉE : - W/H 0.97 D/S

GRAYNESS - NETTETÉ : N/A

HUE ERROR - DÉVIATION DE : N/A
TEINTE

INK EFFICIENCY : N/A
EFFICACITÉ DE L'ENCRE

DENSITOMETRY / DENSITOMÉTRIE

- CHANNEL-SÉLECTION: YELLOW/JAUNE
- FILTER TYPE DE FILTRES: STATUS T
- FACTEUR n FACTOR: 2.7

* Pantone, Inc.'s check-standard trademark for colour reproduction and colour reproduction materials.
* La marque de Pantone, Inc. de contrôle uniforme pour la reproduction en couleur et les matériaux pour la reproduction en couleur.

CIE CHROMATICITY DIAGRAM(ME) DES CHROMATICITÉS CIE

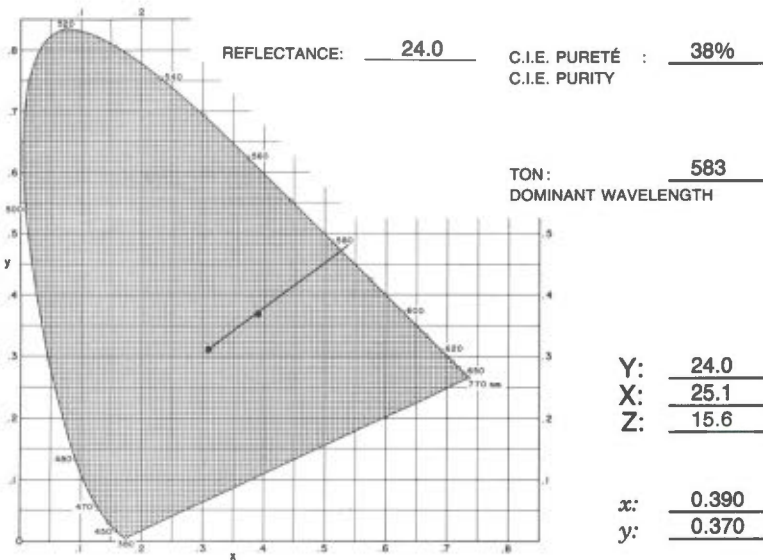

PAPER - PAPIER

GRADE / CATÉGORIE: W.S. STANDARD

TYPE: UNCOATED - NON COUCHÉ

REFLECTIVITÉ / REFLECTIVITY: 78%

OPACITÉ / OPACITY: 86.7%

% CONTRASTE/CONTRAST: 18%

PLATE - PLAQUE

SUBT. - SOUST.

TYPE: NEGATIVE

PRESS - PRESSE

• MEIHLE

• UNIT(É) #: LOWER/INFÉRIEURE

ID. PATCHES BLOCS IDEN.	% SCREEN TRAME	DENSITY DENSITÉ	% PRINT IMPRESSION
A	3	.12	6
B	6	.15	10
C	12	.20	17
D	22	.26	29
E	30	.34	39
F	40	.43	51
G	52	.52	61
H	66	.63	71
I	77	.73	83
J	87	.83	91
M	14	.23	21
N	27	.35	39
O	37	.41	48
P	51	.50	58
SOLID TEINTE PLATE	100	.92	100

The colour printed here was blended from, and should only be blended from PANTONE Basic Colours obtained from a PANTONE Licensed Printing Ink Manufacturer.
Pantone, Inc. assumes no responsibility for the accuracy of the formulas or the colour reproduced.

La couleur ci-imprimée fut et devrait être mélangée seulement à partir des couleurs de base PANTONE obtenues d'un fabricant d'encre autorisé.
La compagnie Pantone, Inc. n'assume aucune responsabilité quant à l'exactitude du mélange ou de la couleur obtenue.

RDD - DRD
COLOURS AND SCREENS
COULEURS ET TRAMES

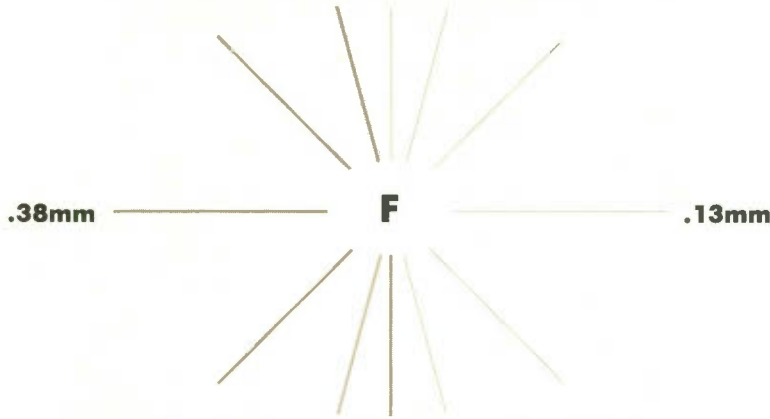

BIANGULAR SCREENS — TRAMES BIANGULÉES

M

6 pt. Triumvirate Roman/Romain
8 pt. Triumvirate Roman/Romain
10 pt. Futura Roman/Romain
12 pt. CG Trade Condensed/Condensé

.08mm
.13mm
.18mm
.25mm
.38mm

N

6 pt. Triumvirate Roman/Romain
8 pt. Futura Roman/Romain
10 pt. CG Trade Condensed/Condensé
12 pt. Cent. Text It./Italique

.08mm
.13mm
.18mm
.25mm
.38mm

O

6 pt. Futura Roman/Romain
8 pt. CG Trade Condensed/Condensé
10 pt. Century Text Italic/Italique
12 pt. Trium. Rom./Romain

.08mm
.13mm
.18mm
.25mm
.38mm

P

6 pt. CG Trade Condensed/Condensé
8 pt. Century Text Italic/Italique
10 pt. Triumvirate Roman/Romain
12 pt. Futura Roman/Romain

.08mm
.13mm
.18mm
.25mm
.38mm

SOLID — TEINTE PLATE

6 pt. Century Text Italic/Italique
8 pt. Triumvirate Roman/Romain
10 pt. Futura Roman/Romain
12 pt. CG Trade Condensed/Condensé

.08mm
.13mm
.18mm
.25mm
.38mm

A
B
C
D
E
F
G
H
I
J
S

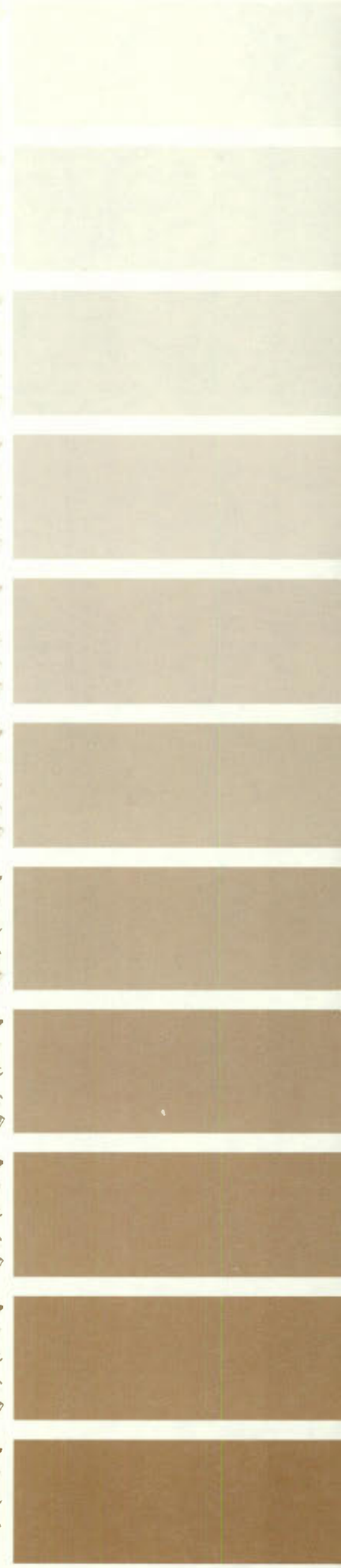

TECHNICAL INFORMATION — DONNÉES TECHNIQUES

INK - ENCRE

PANTONE® * FORMUL (A/E)

COLOUR No. COULEUR : M-5832-464

- .2920 parts Pantone Rubine Red
- .1180 parts Pantone Process Blue
- .5340 parts Pantone Process Yellow
- .0560 parts Pantone Mixing Black

AIM SOLID DENSITY
DENSITÉ TEINTE PLATE VISÉE : 0.92 W/H 0.90 D/S

GRAYNESS - NETTETÉ : N/A

HUE ERROR - DÉVIATION DE : N/A
TEINTE

INK EFFICIENCY : N/A
EFFICACITÉ DE L'ENCRE

DENSITOMETRY / DENSITOMÉTRIE

- CHANNEL-SÉLECTION: YELLOW/JAUNE
- FILTER TYPE DE FILTRES: STATUS T
- FACTEUR n FACTOR: 2.7

* Pantone, Inc.'s check-standard trademark for colour reproduction and colour reproduction materials.

* La marque de Pantone, Inc. de contrôle uniforme pour la reproduction en couleur et les matériaux pour la reproduction en couleur.

CIE CHROMATICITY DIAGRAM(ME) DES CHROMATICITÉS CIE

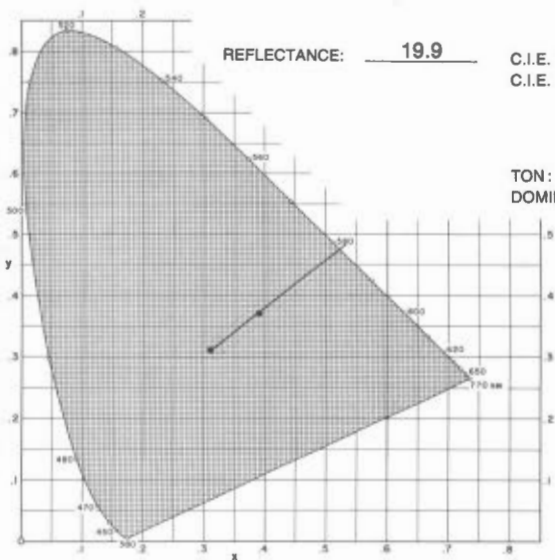

PAPER - PAPIER

PLATE - PLAQUE

GRADE / CATÉGORIE: W.S. NEW BRITE

SUBT. - SOUST.

TYPE: UNCOATED - NON COUCHÉ

TYPE: NEGATIVE

REFLECTIVITÉ / REFLECTIVITY: 83%

PRESS - PRESSE

OPACITÉ / OPACITY: 86.7%

• MEIHLE

% CONTRASTE/CONTRAST: 21%

• UNIT(É) #: LOWER/INFÉRIEURE

ID. PATCHES BLOCS IDEN.	% SCREEN TRAME	DENSITY DENSITÉ	% PRINT IMPRESSION
A	3	.12	3
B	6	.14	7
C	12	.18	14
D	22	.25	24
E	30	.31	34
F	40	.41	45
G	52	.50	57
H	66	.63	68
I	77	.73	81
J	87	.83	90
M	14	.21	18
N	27	.33	34
O	37	.40	44
P	51	.48	55
SOLID TEINTE PLATE	100	.90	100

The colour printed here was blended from, and should only be blended from PANTONE Basic Colours obtained from a PANTONE Licensed Printing Ink Manufacturer.

Pantone, Inc. assumes no responsibility for the accuracy of the formulas or the colour reproduced.

La couleur ci-imprimée fut et devrait être mélangée seulement à partir des couleurs de base PANTONE obtenues d'un fabricant d'encre autorisé.

La compagnie Pantone, Inc. n'assume aucune responsabilité quant à l'exactitude du mélange ou de la couleur obtenue.

RDD - DRD

COLOURS AND SCREENS

COULEURS ET TRAMES

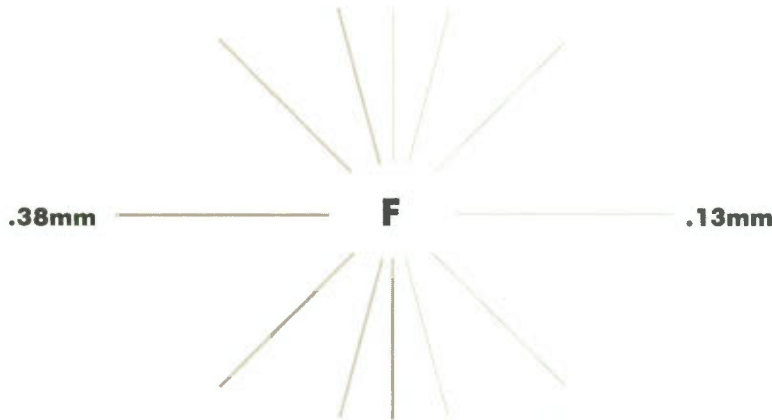

BIANGULAR SCREENS — TRAMES BIANGULÉES

M

4 pt. Century Text Italic/Italique	.08mm	
5 pt. Triumvirate Roman/Romain	.13mm	
10 pt. Futura Roman/Romain	.18mm	
12 pt. CG Trade Condensed/Condensé	.25mm	
	.38mm	

N

6 pt. Triumvirate Roman/Romain	.08mm	
8 pt. Futura Roman/Romain	.13mm	
10 pt. CG Trade Condensed/Condensé	.18mm	
12 pt. Cent. Text It./Italique	.25mm	
	.38mm	

O

6 pt. Futura Roman/Romain	.08mm	
8 pt. CG Trade Condensed/Condensé	.13mm	
10 pt. Century Text Italic/Italique	.18mm	
12 pt. Trium. Rom./Romain	.25mm	
	.38mm	

P

6 pt. CG Trade Condensed/Condensé	.08mm	
8 pt. Century Text Italic/Italique	.13mm	
10 pt. Triumvirate Roman/Romain	.18mm	
12 pt. Futura Roman/Romain	.25mm	
	.38mm	

SOLID — TEINTE PLATE

6 pt. Century Text Italic/Italique	.08mm	
8 pt. Triumvirate Roman/Romain	.13mm	
10 pt. Futura Roman/Romain	.18mm	
12 pt. CG Trade Condensed/Condensé	.25mm	
	.38mm	

A
B
C
D
E
F
G
H
I
J
S

TECHNICAL INFORMATION — DONNÉES TECHNIQUES

INK - ENCRE

PANTONE® * FORMUL (A/E)

COLOUR No. COULEUR : M5860-130

- .565 parts Pantone Yellow
- .239 parts Pantone Warm Red
- .087 parts Pantone Rubine Red
- .109 parts Pantone Black

AIM SOLID DENSITY
DENSITÉ TEINTE PLATE VISÉE : 1.07 W/H 0.98 D/S

GRAYNESS - NETTETÉ : N/A

HUE ERROR - DÉVIATION DE : N/A
TEINTE

INK EFFICIENCY : N/A
EFFICACITÉ DE L'ENCRE

DENSITOMETRY / DENSITOMÉTRIE

- CHANNEL-SÉLECTION: YELLOW/JAUNE
- FILTER TYPE DE FILTRES: STATUS "T"
- FACTEUR n FACTOR: 2.7

* Pantone, Inc.'s check-standard trademark for colour reproduction and colour reproduction materials.
* La marque de Pantone, Inc. de contrôle uniforme pour la reproduction en couleur et les matériaux pour la reproduction en couleur.

ID. PATCHES BLOCS IDEN.	% SCREEN FRAME	DENSITY DENSITÉ	% PRINT IMPRESSION
A	3	.13	5
B	6	.16	9
C	12	.20	17
D	22	.29	28
E	30	.36	41
F	40	.46	52
G	52	.62	66
H	66	.73	82
I	77	.81	92
J	87	.83	98
M	14	.26	24
N	27	.39	42
O	37	.46	51
P	51	.56	64
SOLID TEINTE PLATE	100	.94	100

CIE CHROMATICITY DIAGRAM(ME) DES CHROMATICITÉS CIE

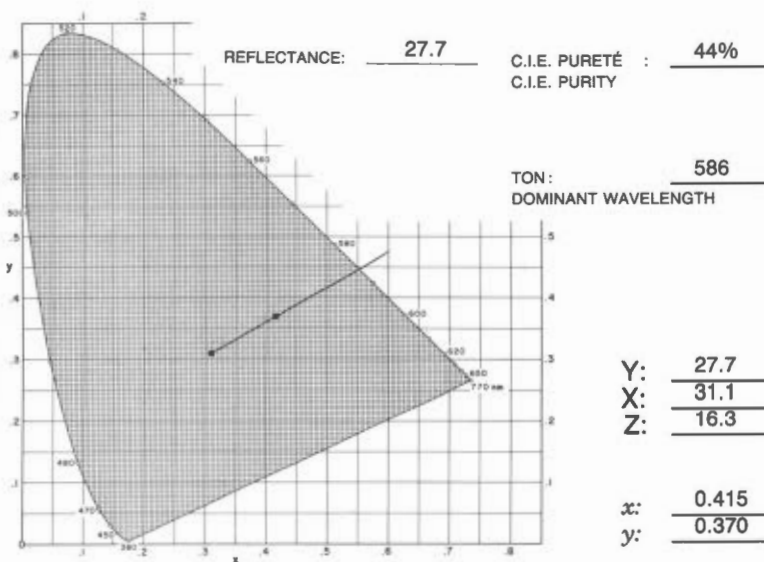

PAPER - PAPIER

GRADE / CATÉGORIE: W.S. STANDARD

TYPE: UNCOATED - NON COUCHÉ

REFLECTIVITÉ / REFLECTIVITY: 79%

OPACITÉ / OPACITY: 87%

% CONTRASTE/CONTRAST: 14%

PLATE - PLAQUE

SUBT. - SOUST.

TYPE: NEGATIVE

PRESS - PRESSE

• MEIHLE

• UNIT(É) #: LOWER/INFÉRIEURE

The colour printed here was blended from, and should only be blended from PANTONE Basic Colours obtained from a PANTONE Licensed Printing Ink Manufacturer.
Pantone, Inc. assumes no responsibility for the accuracy of the formulas or the colour reproduced.

La couleur ci- imprimée fut et devrait être mélangée seulement à partir des couleurs de base PANTONE obtenues d'un fabricant d'encre autorisé.
La compagnie Pantone, Inc. n'assume aucune responsabilité quant à l'exactitude du mélange ou de la couleur obtenue.

RDD - DRD

COLOURS AND SCREENS

COULEURS ET TRAMES

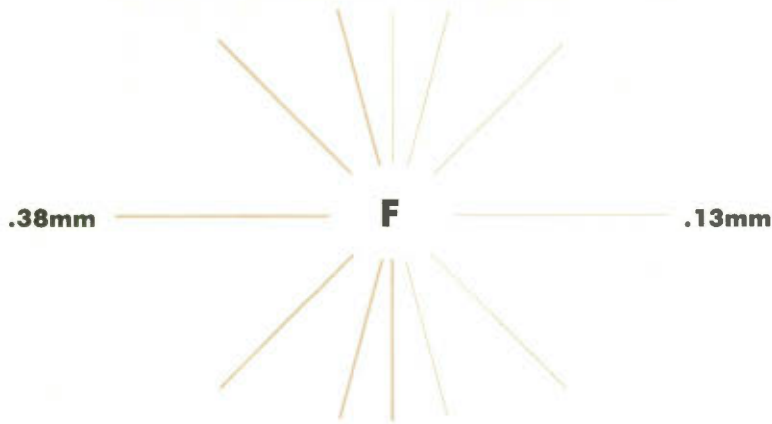

BIANGULAR SCREENS — TRAMES BIANGULÉES

M

6 pt. *Century Text Italic/Italique*
8 pt. *Triumvirate Roman/Romain*
10 pt. *Futura Roman/Romain*
12 pt. *CG Trade Condensed/Condensé*



N

6 pt. *Triumvirate Roman/Romain*
8 pt. *Futura Roman/Romain*
10 pt. *CG Trade Condensed/Condensé*
12 pt. *Cent. Text It./Italique*



O

6 pt. *Futura Roman/Romain*
8 pt. *CG Trade Condensed/Condensé*
10 pt. *Century Text Italic/Italique*
12 pt. *Trium. Rom./Romain*



P

6 pt. *CG Trade Condensed/Condensé*
8 pt. *Century Text Italic/Italique*
10 pt. *Triumvirate Roman/Romain*
12 pt. *Futura Roman/Romain*



SOLID — TEINTE PLATE

6 pt. *Century Text Italic/Italique*
8 pt. *Triumvirate Roman/Romain*
10 pt. *Futura Roman/Romain*
12 pt. *CG Trade Condensed/Condensé*



A

B

C

D

E

F

G

H

I

J

S

TECHNICAL INFORMATION — DONNÉES TECHNIQUES

INK - ENCRE

PANTONE® * FORMUL (A/E)

COLOUR No. COULEUR : M5860-130

- .565 parts Pantone Yellow
- .239 parts Pantone Warm Red
- .087 parts Pantone Rubine Red
- .109 parts Pantone Black

AIM SOLID DENSITY
DENSITÉ TEINTE PLATE VISÉE : 1.09 W/H 1.04 D/S

GRAYNESS - NETTETÉ : N/A

HUE ERROR - DÉVIATION DE : N/A
TEINTE

INK EFFICIENCY : N/A
EFFICACITÉ DE L'ENCRE

DENSITOMETRY / DENSITOMÉTRIE

- CHANNEL-SÉLECTION: YELLOW/JAUNE
- FILTER TYPE DE FILTRES: STATUS "T"
- FACTEUR n FACTOR: 2.7

* Pantone, Inc.'s check-standard trademark for colour reproduction and colour reproduction materials.

* La marque de Pantone, Inc. de contrôle uniforme pour la reproduction en couleur et les matériaux pour la reproduction en couleur.

CIE CHROMATICITY DIAGRAM(ME) DES CHROMATICITÉS CIE

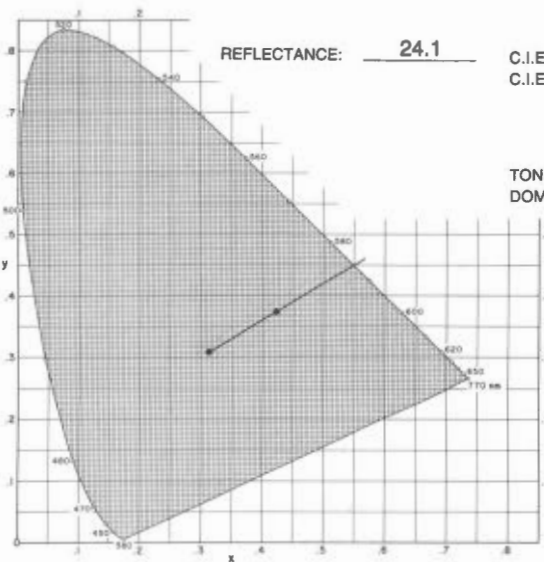

REFLECTANCE: 24.1 C.I.E. PURETÉ : 46%
C.I.E. PURITY

TON: 586
DOMINANT WAVELENGTH

Y: 24.1
X: 27.4
Z: 13.7

x: 0.420
y: 0.370

PAPER - PAPIER

GRADE / CATÉGORIE: W.S. NEW BR.

TYPE: UNCOATED - NON COUCHÉ

REFLECTIVITÉ / REFLECTIVITY: 81%

OPACITÉ / OPACITY: 85.5%

% CONTRASTE/CONTRAST: 16%

PLATE - PLAQUE

SUBT. - SOUST.

TYPE: NEGATIVE

PRESS - PRESSE

• MEIHLE

• UNIT(É) #: LOWER/INFÉRIEURE

ID. PATCHES BLOCS IDEN.	% SCREEN FRAME	DENSITY DENSITÉ	% PRINT IMPRESSION
A	3	.13	7
B	6	.15	10
C	12	.20	18
D	22	.28	28
E	30	.36	38
F	40	.45	51
G	52	.60	68
H	66	.73	81
I	77	.82	89
J	87	.90	95
M	14	.25	24
N	27	.37	41
O	37	.46	50
P	51	.57	63
SOLID TEINTE PLATE	100	.98	100

The colour printed here was blended from, and should only be blended from PANTONE Basic Colours obtained from a PANTONE Licensed Printing Ink Manufacturer. Pantone, Inc. assumes no responsibility for the accuracy of the formulas or the colour reproduced.

La couleur ci-imprimée fut et devrait être mélangée seulement à partir des couleurs de base PANTONE obtenues d'un fabricant d'encre autorisé. La compagnie Pantone, Inc. n'assume aucune responsabilité quant à l'exactitude du mélange ou de la couleur obtenue.

RDD - DRD
COLOURS AND SCREENS
COULEURS ET TRAMES

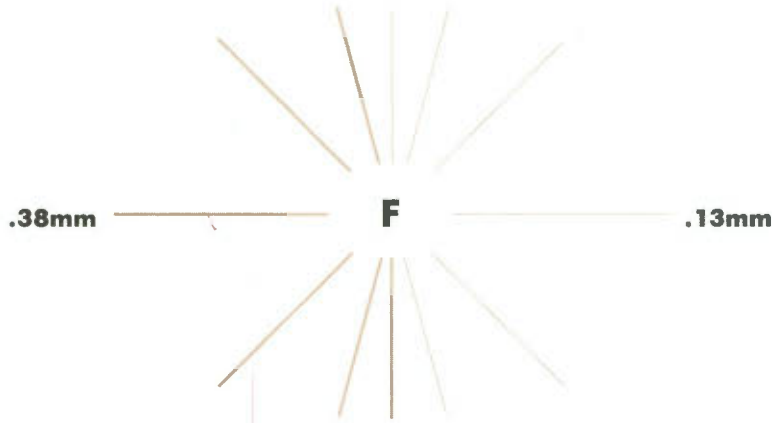

BIANGULAR SCREENS — TRAMES BIANGULÉES

M

4 pt. <i>Century Text Italic/Italique</i>	.08mm	
8 pt. <i>Triumvirate Roman/Romain</i>	.13mm	
10 pt. <i>Futura Roman/Romain</i>	.18mm	
12 pt. <i>CG Trade Condensed/Condensé</i>	.25mm	
	.38mm	

N

6 pt. <i>Triumvirate Roman/Romain</i>	.08mm	
8 pt. <i>Futura Roman/Romain</i>	.13mm	
10 pt. <i>CG Trade Condensed/Condensé</i>	.18mm	
12 pt. <i>Cent. Text It./Italique</i>	.25mm	
	.38mm	

O

6 pt. <i>Futura Roman/Romain</i>	.08mm	
8 pt. <i>CG Trade Condensed/Condensé</i>	.13mm	
10 pt. <i>Century Text Italic/Italique</i>	.18mm	
12 pt. <i>Trium. Rom./Romain</i>	.25mm	
	.38mm	

P

6 pt. <i>CG Trade Condensed/Condensé</i>	.08mm	
8 pt. <i>Century Text Italic/Italique</i>	.13mm	
10 pt. <i>Triumvirate Roman/Romain</i>	.18mm	
12 pt. <i>Futura Roman/Romain</i>	.25mm	
	.38mm	

SOLID — TEINTE PLATE

6 pt. <i>Century Text Italic/Italique</i>	.08mm	
8 pt. <i>Triumvirate Roman/Romain</i>	.13mm	
10 pt. <i>Futura Roman/Romain</i>	.18mm	
12 pt. <i>CG Trade Condensed/Condensé</i>	.25mm	
	.38mm	

A

B

C

D

E

F

G

H

I

J

S



TECHNICAL INFORMATION — DONNÉES TECHNIQUES

INK - ENCRE

PANTONE® * FORMUL (A)_E

- .5480 parts Pantone Warm Red
- .2650 parts Pantone Green
- .0990 parts Pantone Yellow
- .0880 parts Pantone Black

COLOUR No. COULEUR : M-5950-133

AIM SOLID DENSITY
DENSITÉ TEINTE PLATE VISÉE: 1.10 W/H 1.05 D/S

GRAYNESS - NETTETÉ : N/A

HUE ERROR - DÉVIATION DE : N/A
TEINTE

INK EFFICIENCY : N/A
EFFICACITÉ DE L'ENCRE

DENSITOMETRY / DENSITOMÉTRIE

- CHANNEL-SÉLECTION: YELLOW/JAUNE
- FILTER TYPE DE FILTRES: STATUS T
- FACTEUR n FACTOR: 2.7

* Pantone, Inc.'s check-standard trademark for colour reproduction and colour reproduction materials.
* La marque de Pantone, Inc. de contrôle uniforme pour la reproduction en couleur et les matériaux pour la reproduction en couleur.

CIE CHROMATICITY DIAGRAM(ME) DES CHROMATICITÉS CIE

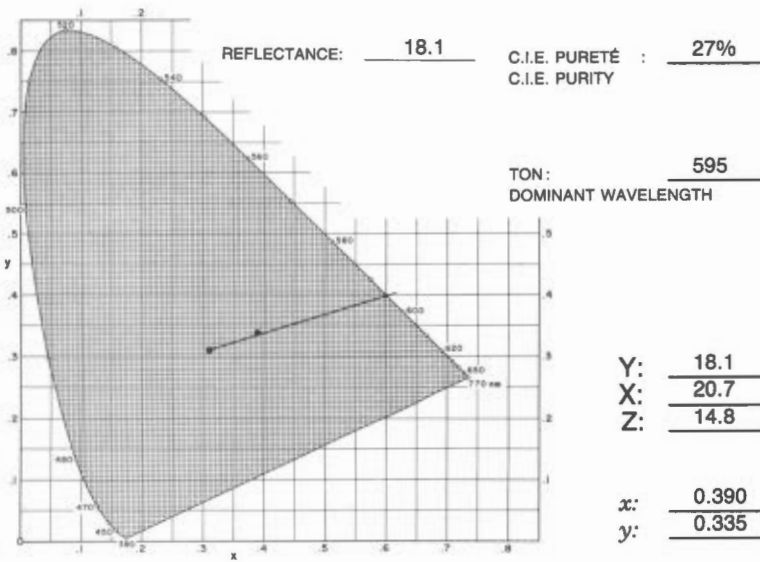

ID. PATCHES BLOCS IDEN.	% SCREEN TRAME	DENSITY DENSITÉ	% PRINT IMPRESSION
A	3	.13	7
B	6	.16	12
C	12	.20	20
D	22	.28	31
E	30	.36	41
F	40	.45	53
G	52	.60	71
H	66	.76	85
I	77	.83	93
J	87	.90	97
M	14	.24	24
N	27	.37	41
O	37	.44	52
P	51	.55	66
SOLID TEINTE PLATE	100	.96	100

PAPER - PAPIER

GRADE / CATÉGORIE: W.S. STANDARD

TYPE: UNCOATED - NON COUCHÉ

REFLECTIVITÉ / REFLECTIVITY: 81%

OPACITÉ / OPACITY: 87%

% CONTRASTE/CONTRAST: 14%

PLATE - PLAQUE

SUBT. - SOUST.

TYPE: NEGATIVE

PRESS - PRESSE

• MEIHLE

• UNIT(É) #: LOWER/INFÉRIEURE

The colour printed here was blended from, and should only be blended from PANTONE Basic Colours obtained from a PANTONE Licensed Printing Ink Manufacturer. Pantone, Inc. assumes no responsibility for the accuracy of the formulas or the colour reproduced.

La couleur ci-imprimée fut et devrait être mélangée seulement à partir des couleurs de base PANTONE obtenues d'un fabricant d'encre autorisé. La compagnie Pantone, Inc. n'assume aucune responsabilité quant à l'exactitude du mélange ou de la couleur obtenue.

RDD - DRD

COLOURS AND SCREENS

COULEURS ET TRAMES

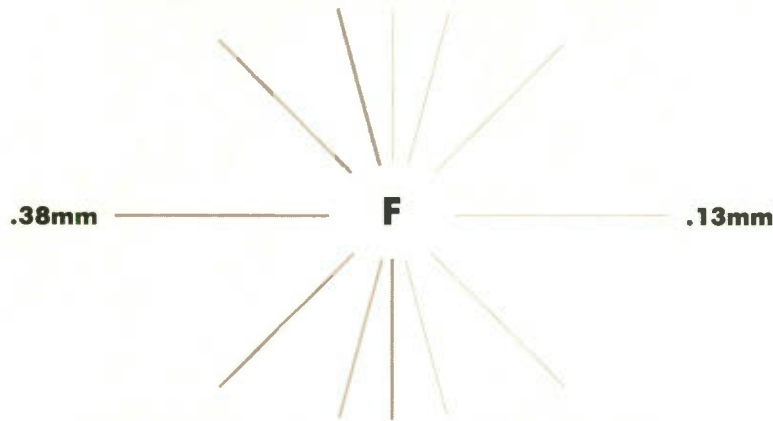

BIANGULAR SCREENS — TRAMES BIANGULÉES

M

6 pt. Century Text Italic/Italique
8 pt. Triumvirate Roman/Romain
10 pt. Futura Roman/Romain
12 pt. CG Trade Condensed/Condensé

.06mm	_____	
.13mm	_____	
.18mm	_____	
.25mm	_____	
.38mm	_____	

N

8 pt. Triumvirate Roman/Romain
8 pt. Futura Roman/Romain
10 pt. CG Trade Condensed/Condensé
12 pt. Cent. Text It./Italique

.06mm	_____	
.13mm	_____	
.18mm	_____	
.25mm	_____	
.38mm	_____	

O

6 pt. Futura Roman/Romain
8 pt. CG Trade Condensed/Condensé
10 pt. Century Text Italic/Italique
12 pt. Trium. Rom./Romain

.06mm	_____	
.13mm	_____	
.18mm	_____	
.25mm	_____	
.38mm	_____	

P

6 pt. CG Trade Condensed/Condensé
8 pt. Century Text Italic/Italique
10 pt. Triumvirate Roman/Romain
12 pt. Futura Roman/Romain

.06mm	_____	
.13mm	_____	
.18mm	_____	
.25mm	_____	
.38mm	_____	

SOLID — TEINTE PLATE

6 pt. Century Text Italic/Italique
8 pt. Triumvirate Roman/Romain
10 pt. Futura Roman/Romain
12 pt. CG Trade Condensed/Condensé

.06mm	_____	
.13mm	_____	
.18mm	_____	
.25mm	_____	
.38mm	_____	

A

B

C

D

E

F

G

H

I

J

S

TECHNICAL INFORMATION — DONNÉES TECHNIQUES

INK - ENCRE

PANTONE® * FORMUL (A/E)

COLOUR No. COULEUR : M-5950-133

- .5480 parts Pantone Warm Red
- .2650 parts Pantone Green
- .0990 parts Pantone Yellow
- .0880 parts Pantone Black

AIM SOLID DENSITY
DENSITÉ TEINTE PLATE VISÉE : 1.05 W/H 0.95 D/S

GRAYNESS - NETTETÉ : N/A

HUE ERROR - DÉVIATION DE : N/A
TEINTE

INK EFFICIENCY : N/A
EFFICACITÉ DE L'ENCRE

DENSITOMETRY / DENSITOMÉTRIE

- CHANNEL-SÉLECTION: YELLOW/JAUNE
- FILTER TYPE DE FILTRES: STATUS T
- FACTEUR n FACTOR: 2.7

* Pantone, Inc.'s check-standard trademark for colour reproduction and colour reproduction materials.

* La marque de Pantone, Inc. de contrôle uniforme pour la reproduction en couleur et les matériaux pour la reproduction en couleur.

CIE CHROMATICITY DIAGRAM(ME) DES CHROMATICITÉS CIE

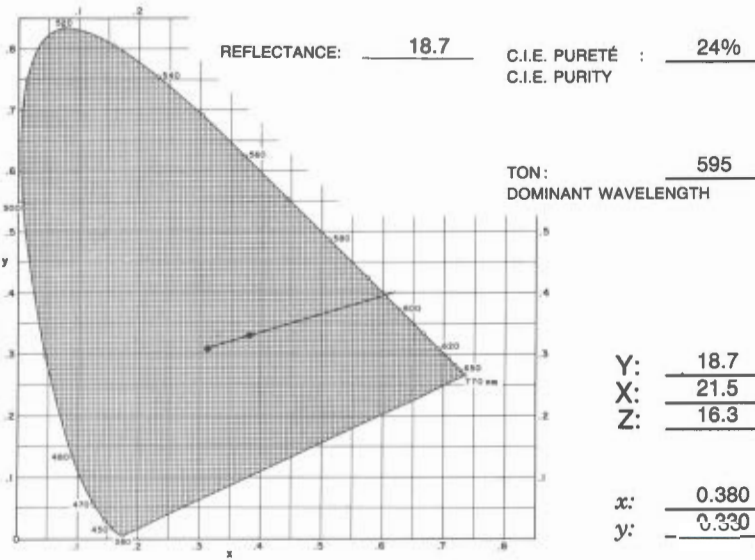

ID. PATCHES BLOCS IDEN.	% SCREEN FRAME	DENSITY DENSITÉ	% PRINT IMPRESSION
A	3	.11	7
B	6	.13	11
C	12	.20	19
D	22	.26	30
E	30	.35	42
F	40	.46	55
G	52	.61	73
H	66	.76	87
I	77	.84	92
J	87	.88	96
M	14	.24	27
N	27	.38	44
O	37	.46	54
P	51	.58	69
SOLID TEINTE PLATE	100	.92	100

PAPER - PAPIER

GRADE / CATÉGORIE: W.S. NEW BRITE

TYPE: UNCOATED - NON COUCHÉ

REFLECTIVITÉ / REFLECTIVITY: 85%

OPACITÉ / OPACITY: 85.5%

% CONTRASTE/CONTRAST: 9%

PLATE - PLAQUE

SUBT. - SOUST.

TYPE: NEGATIVE

PRESS - PRESSE

• MEIHLE

• UNIT(É) #: LOWER/INFÉRIEURE

The colour printed here was blended from, and should only be blended from PANTONE Basic Colours obtained from a PANTONE Licensed Printing Ink Manufacturer. Pantone, Inc. assumes no responsibility for the accuracy of the formulas or the colour reproduced.

La couleur ci-imprimée fut et devrait être mélangée seulement à partir des couleurs de base PANTONE obtenues d'un fabricant d'encre autorisé. La compagnie Pantone, Inc. n'assume aucune responsabilité quant à l'exactitude du mélange ou de la couleur obtenue.

RDD - DRD

COLOURS AND SCREENS

COULEURS ET TRAMES

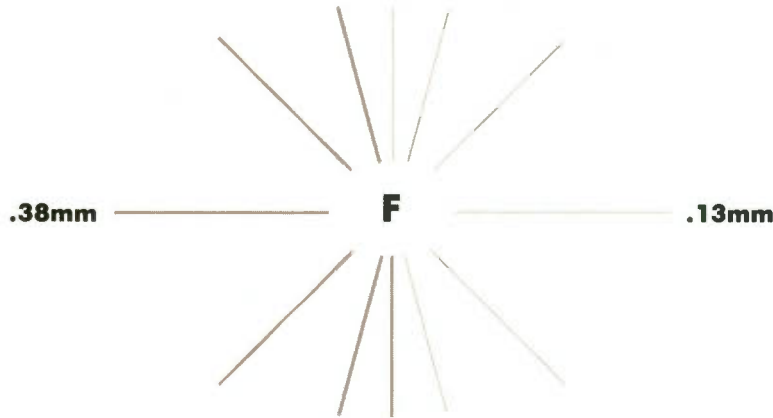

BIANGULAR SCREENS — TRAMES BIANGULÉES

M

6 pt. Century Text Italic/Italique
8 pt. Triumvirate Roman/Romain
10 pt. Futura Roman/Romain
12 pt. CG Trade Condensed/Condensé



N

6 pt. Triumvirate Roman/Romain
8 pt. Futura Roman/Romain
10 pt. CG Trade Condensed/Condensé
12 pt. Cent. Text It./Italique



O

6 pt. Futura Roman/Romain
8 pt. CG Trade Condensed/Condensé
10 pt. Century Text Italic/Italique
12 pt. Trium. Rom./Romain



P

6 pt. CG Trade Condensed/Condensé
8 pt. Century Text Italic/Italique
10 pt. Triumvirate Roman/Romain
12 pt. Futura Roman/Romain



SOLID — TEINTE PLATE

6 pt. Century Text Italic/Italique
8 pt. Triumvirate Roman/Romain
10 pt. Futura Roman/Romain
12 pt. CG Trade Condensed/Condensé



A

B

C

D

E

F

G

H

I

J

S

ACHROMATIC COLOURS - COULEURS ACHROMATIQUES

Colour No. Couleur	Name/Nom
A-4720 (106)	Grey Shading
A-5040 (117)	Blue Park Gray
A-5050 (431)	Grey Loran Off. Jog
A-5642 (109)	Grey Chart
A-5690 (57003)	Grey Jog
A-5700 (107)	Grey Transparent
A-0101 (101)	Black Map

TECHNICAL INFORMATION — DONNÉES TECHNIQUES

INK - ENCRE

PANTONE® * FORMUL (A)
(E)

COLOUR No. COULEUR : A-4720-106

AIM SOLID DENSITY
DENSITÉ TEINTE PLATE VISÉE : 0.85 W/H 0.72 D/S

GRAYNESS - NETTETÉ : N/A

HUE ERROR - DÉVIATION DE : N/A
TEINTE

INK EFFICIENCY : N/A
EFFICACITÉ DE L'ENCRE

DENSITOMETRY / DENSITOMÉTRIE

• CHANNEL-SÉLECTION: YELLOW/JAUNE

• FILTER TYPE DE FILTRES: STATUS T

• FACTEUR n FACTOR: 2.7

* Pantone, Inc.'s check-standard trademark for colour reproduction and colour reproduction materials.
* La marque de Pantone, Inc. de contrôle uniforme pour la reproduction en couleur et les matériaux pour la reproduction en couleur.

CIE CHROMATICITY DIAGRAM(ME) DES CHROMATICITÉS CIE

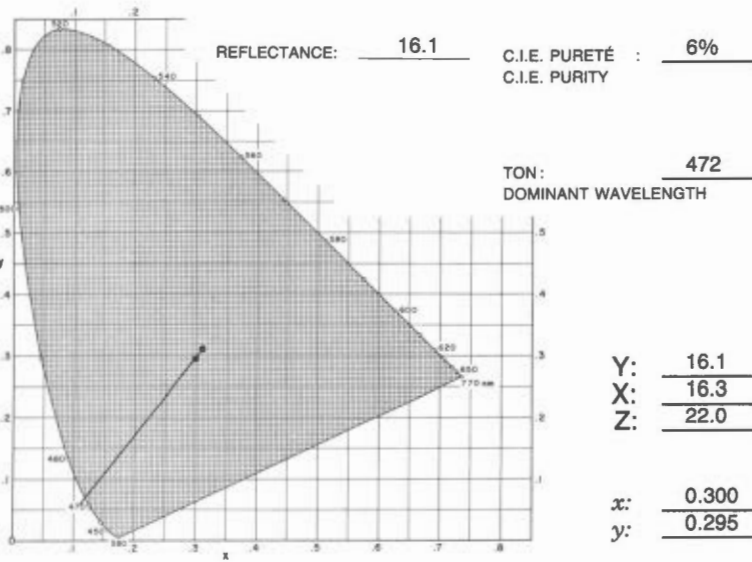

ID. PATCHES BLOCS IDEN.	% SCREEN TRAME	DENSITY DENSITE	% PRINT IMPRESSION
A	3	.11	4
B	6	.12	7
C	12	.16	15
D	22	.22	25
E	30	.27	34
F	40	.34	46
G	52	.41	58
H	66	.49	71
I	77	.58	85
J	87	.63	91
M	14	.18	20
N	27	.27	36
O	37	.34	46
P	51	.40	57
SOLID TEINTE PLATE	100	.71	100

PAPER - PAPIER

GRADE / CATÉGORIE: W.S. STANDARD

TYPE: UNCOATED - NON COUCHÉ

REFLECTIVITÉ / REFLECTIVITY: 81%

OPACITÉ / OPACITY: 87%

% CONTRASTE/CONTRAST: 18%

PLATE - PLAQUE

SUBT. - SOUST. _____

TYPE: NEGATIVE

PRESS - PRESSE

• MEIHLE

• UNIT(É) #: LOWER/INFÉRIEURE

The colour printed here was blended from, and should only be blended from PANTONE Basic Colours obtained from a PANTONE Licensed Printing Ink Manufacturer.
Pantone, Inc. assumes no responsibility for the accuracy of the formulas or the colour reproduced.

La couleur ci-imprimée fut et devrait être mélangée seulement à partir des couleurs de base PANTONE obtenues d'un manufacturier d'encre autorisé.
La compagnie Pantone, Inc. n'assume aucune responsabilité quant à l'exactitude du mélange ou de la couleur obtenue.

RDD - DRD

COLOURS AND SCREENS

COULEURS ET TRAMES

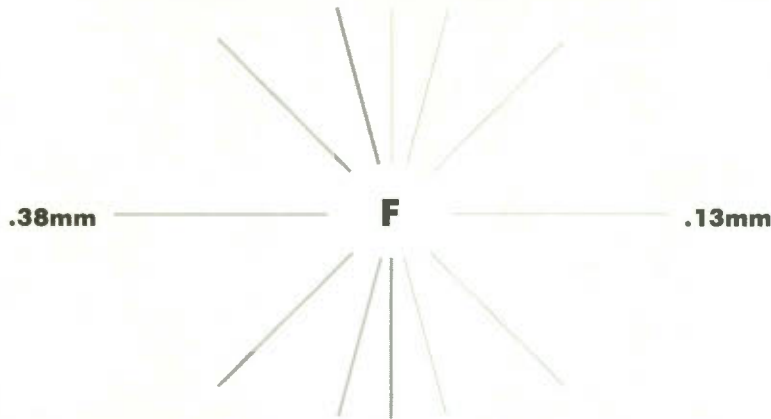

BIANGULAR SCREENS — TRAMES BIANGULÉES

M

18 pt. Triumvirate Roman/Romain	.08mm	
8 pt. Triumvirate Roman/Romain	.15mm	
10 pt. Futura Roman/Romain	.18mm	
12 pt. CG Trade Condensed/Condensé	.25mm	
	.38mm	

N

6 pt. Triumvirate Roman/Romain	.08mm	
8 pt. Futura Roman/Romain	.15mm	
10 pt. CG Trade Condensed/Condensé	.18mm	
12 pt. Cent. Text It./Italique	.25mm	
	.38mm	

O

6 pt. Futura Roman/Romain	.08mm	
8 pt. CG Trade Condensed/Condensé	.15mm	
10 pt. Century Text Italic/Italique	.18mm	
12 pt. Trium. Rom./Romain	.25mm	
	.38mm	

P

6 pt. CG Trade Condensed/Condensé	.08mm	
8 pt. Century Text Italic/Italique	.15mm	
10 pt. Triumvirate Roman/Romain	.18mm	
12 pt. Futura Roman/Romain	.25mm	
	.38mm	

SOLID — TEINTE PLATE

6 pt. Century Text Italic/Italique	.08mm	
8 pt. Triumvirate Roman/Romain	.15mm	
10 pt. Futura Roman/Romain	.18mm	
12 pt. CG Trade Condensed/Condensé	.25mm	
	.38mm	

A

B

C

D

E

F

G

H

I

J

S

TECHNICAL INFORMATION — DONNÉES TECHNIQUES

INK - ENCRE

PANTONE® * FORMUL (A/E)

COLOUR No. COULEUR : A-4720-106

AIM SOLID DENSITY
DENSITÉ TEINTE PLATE VISÉE : 0.88 W/H 0.68 D/S

GRAYNESS - NETTETÉ : N/A

HUE ERROR - DÉVIATION DE : N/A
TEINTE

INK EFFICIENCY : N/A
EFFICACITÉ DE L'ENCRE

DENSITOMETRY / DENSITOMÉTRIE

• CHANNEL-SÉLECTION: YELLOW/JAUNE

• FILTER TYPE DE FILTRES: STATUS T

• FACTEUR n FACTOR: 2.7

* Pantone, Inc.'s check-standard trademark for colour reproduction and colour reproduction materials.
* La marque de Pantone, Inc. de contrôle uniforme pour la reproduction en couleur et les matériaux pour la reproduction en couleur.

CIE CHROMATICITY DIAGRAM(ME) DES CHROMATICITÉS CIE

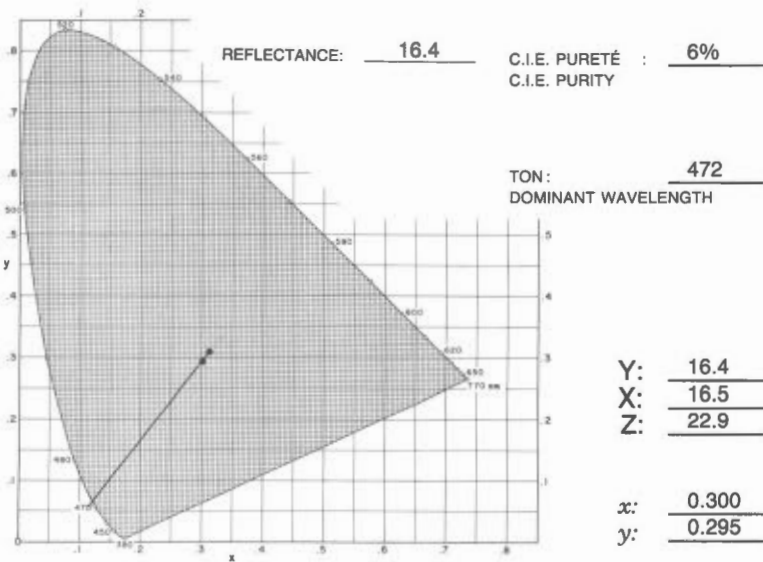

ID. PATCHES BLOCS IDEN.	% SCREEN FRAME	DENSITY DENSITÉ	% PRINT IMPRESSION
A	3	.09	4
B	6	.11	7
C	12	.15	15
D	22	.21	25
E	30	.25	34
F	40	.33	46
G	52	.40	57
H	66	.49	71
I	77	.54	80
J	87	.61	88
M	14	.18	20
N	27	.27	37
O	37	.32	45
P	51	.39	56
SOLID TEINTE PLATE	100	.69	100

PAPER - PAPIER

GRADE / CATÉGORIE: W.S. NEW BRITE

TYPE: UNCOATED - NON COUCHÉ

REFLECTIVITÉ / REFLECTIVITY: 83%

OPACITÉ / OPACITY: 85.5%

% CONTRASTE/CONTRAST: 22%

PLATE - PLAQUE

SUBT. - SOUST.

TYPE: NEGATIVE

PRESS - PRESSE

• MEIHLE

• UNIT(É) #: LOWER/INFÉRIEURE

The colour printed here was blended from, and should only be blended from PANTONE Basic Colours obtained from a PANTONE Licensed Printing Ink Manufacturer.
Pantone, Inc. assumes no responsibility for the accuracy of the formulas or the colour reproduced.

La couleur ci-imprimée fut et devrait être mélangée seulement à partir des couleurs de base PANTONE obtenues d'un fabricant d'encre autorisé.
La compagnie Pantone, Inc. n'assume aucune responsabilité quant à l'exactitude du mélange ou de la couleur obtenue.

RDD - DRD
COLOURS AND SCREENS
COULEURS ET TRAMES

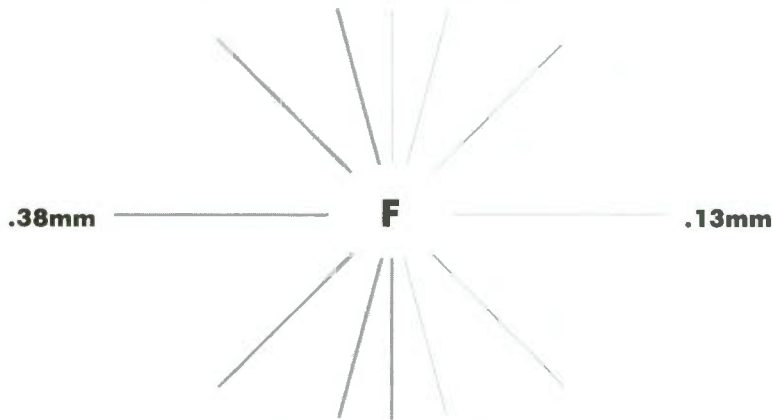

BIANGULAR SCREENS — TRAMES BIANGULÉES

M

6 pt. <i>Century Text Italic/Italique</i>	.08mm	
8 pt. <i>Triumvirate Roman/Romain</i>	.13mm	
10 pt. <i>Futura Roman/Romain</i>	.18mm	
12 pt. <i>CG Trade Condensed/Condensé</i>	.25mm	
	.38mm	

N

6 pt. <i>Triumvirate Roman/Romain</i>	.08mm	
8 pt. <i>Futura Roman/Romain</i>	.13mm	
10 pt. <i>CG Trade Condensed/Condensé</i>	.18mm	
12 pt. <i>Cent. Text It/Italique</i>	.25mm	
	.38mm	

O

6 pt. <i>Futura Roman/Romain</i>	.08mm	
8 pt. <i>CG Trade Condensed/Condensé</i>	.13mm	
10 pt. <i>Century Text Italic/Italique</i>	.18mm	
12 pt. <i>Trium. Rom./Romain</i>	.25mm	
	.38mm	

P

6 pt. <i>CG Trade Condensed/Condensé</i>	.08mm	
8 pt. <i>Century Text Italic/Italique</i>	.13mm	
10 pt. <i>Triumvirate Roman/Romain</i>	.18mm	
12 pt. <i>Futura Roman/Romain</i>	.25mm	
	.38mm	

SOLID — TEINTE PLATE

6 pt. <i>Century Text Italic/Italique</i>	.08mm	
8 pt. <i>Triumvirate Roman/Romain</i>	.13mm	
10 pt. <i>Futura Roman/Romain</i>	.18mm	
12 pt. <i>CG Trade Condensed/Condensé</i>	.25mm	
	.38mm	

A

B

C

D

E

F

G

H

I

J

S

TECHNICAL INFORMATION — DONNÉES TECHNIQUES

INK - ENCRE

PANTONE® * FORMUL (A/E)

COLOUR No. COULEUR : A-5040-117

GRAYNESS - NETTETÉ : N/A

AIM SOLID DENSITY
DENSITÉ TEINTE PLATE VISÉE : 0.44 W/H 0.42 D/S

HUE ERROR - DÉVIATION DE : N/A
TEINTE

DENSITOMETRY / DENSITOMÉTRIE

INK EFFICIENCY : N/A
EFFICACITÉ DE L'ENCRE

• CHANNEL-SÉLECTION: CYAN

• FILTER TYPE DE FILTRES: STATUS T

• FACTEUR n FACTOR: 2.7

* Pantone, Inc.'s check-standard trademark for colour reproduction and colour reproduction materials.
* La marque de Pantone, Inc. de contrôle uniforme pour la reproduction en couleur et les matériaux pour la reproduction en couleur.

CIE CHROMATICITY DIAGRAM(ME) DES CHROMATICITÉS CIE

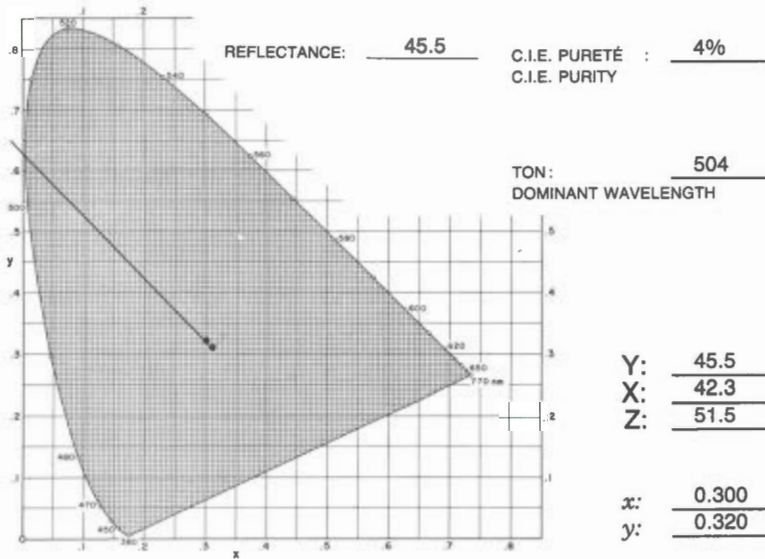

PAPER - PAPIER

GRADE / CATÉGORIE: W.S. STANDARD

TYPE: UNCOATED - NON COUCHÉ

REFLECTIVITÉ / REFLECTIVITY: 87%

OPACITÉ / OPACITY: 87%

% CONTRASTE/CONTRAST: 10%

PLATE - PLAQUE

SUBT. - SOUST.

TYPE: NEGATIVE

PRESS - PRESSE

• MEIHLE

• UNIT(É) #: LOWER/INFÉRIEURE

ID. PATCHES BLOCS IDEN.	% SCREEN TRAME	DENSITY DENSITÉ	% PRINT IMPRESSION
A	3	.08	3
B	6	.09	7
C	12	.11	16
D	22	.15	28
E	30	.18	39
F	40	.23	53
G	52	.27	66
H	66	.31	77
I	77	.34	88
J	87	.36	94
M	14	.12	19
N	27	.18	39
O	37	.21	49
P	51	.25	60
SOLID TEINTE PLATE	100	.40	100

The colour printed here was blended from, and should only be blended from PANTONE Basic Colours obtained from a PANTONE Licensed Printing Ink Manufacturer. Pantone, Inc. assumes no responsibility for the accuracy of the formulas or the colour reproduced.

La couleur ci-imprimée fut et devrait être mélangée seulement à partir des couleurs de base PANTONE obtenues d'un fabricant d'encre autorisé. La compagnie Pantone, Inc. n'assume aucune responsabilité quant à l'exactitude du mélange ou de la couleur obtenue.

TECHNICAL INFORMATION — DONNÉES TECHNIQUES

INK - ENCRE

PANTONE® * FORMUL (A/E)

COLOUR No. COULEUR : A-5040-117

AIM SOLID DENSITY
DENSITÉ TEINTE PLATE VISÉE : 0.46 W/H 0.43 D/S

GRAYNESS - NETTETÉ : N/A

HUE ERROR - DÉVIATION DE : N/A
TEINTE

INK EFFICIENCY : N/A
EFFICACITÉ DE L'ENCRE

DENSITOMETRY / DENSITOMÉTRIE

- CHANNEL-SÉLECTION: CYAN
- FILTER TYPE DE FILTRES: STATUS T
- FACTEUR n FACTOR: 2.7

* Pantone, Inc.'s check-standard trademark for colour reproduction and colour reproduction materials.

* La marque de Pantone, Inc. de contrôle uniforme pour la reproduction en couleur et les matériaux pour la reproduction en couleur.

CIE CHROMATICITY DIAGRAM(ME) DES CHROMATICITÉS CIE

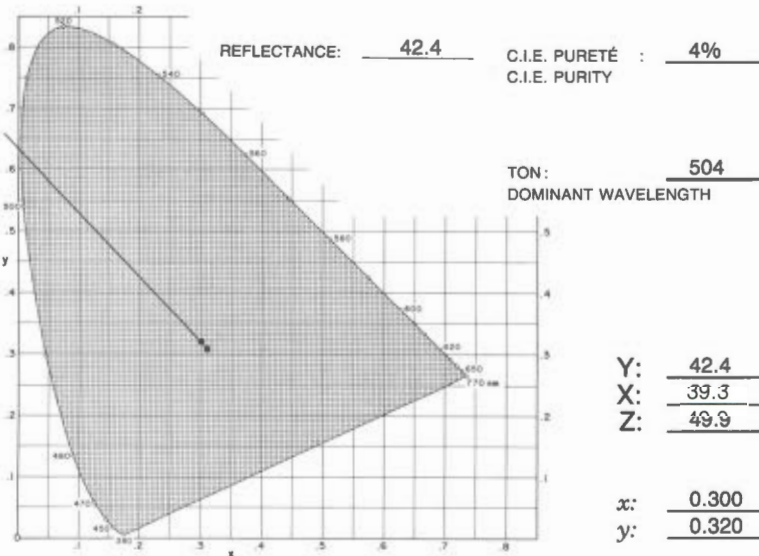

PAPER - PAPIER

GRADE / CATÉGORIE: W.S. NEW BRITE

TYPE: UNCOATED - NON COUCHÉ

REFLECTIVITÉ / REFLECTIVITY: 85%

OPACITÉ / OPACITY: 85.5%

% CONTRASTE/CONTRAST: 12%

PLATE - PLAQUE

SUBT. - SOUST.

TYPE: NEGATIVE

PRESS - PRESSE

• MEHLE

• UNIT(É) #: LOWER/INFÉRIEURE

ID. PATCHES BLOCS IDEN.	% SCREEN TRAME	DENSITY DENSITÉ	% PRINT IMPRESSION
A	3	.09	4
B	6	.10	9
C	12	.12	16
D	22	.15	27
E	30	.19	40
F	40	.23	51
G	52	.28	65
H	66	.32	75
I	77	.36	85
J	87	.38	90
M	14	.13	19
N	27	.19	39
O	37	.22	47
P	51	.26	57
SOLID TEINTE PLATE	100	.41	100

The colour printed here was blended from, and should only be blended from PANTONE Basic Colours obtained from a PANTONE Licensed Printing Ink Manufacturer. Pantone, Inc. assumes no responsibility for the accuracy of the formulas or the colour reproduced.

La couleur ci-imprimée fut et devrait être mélangée seulement à partir des couleurs de base PANTONE obtenues d'un manufacturier d'encre autorisé. La compagnie Pantone, Inc. n'assume aucune responsabilité quant à l'exactitude du mélange ou de la couleur obtenue.

TECHNICAL INFORMATION — DONNÉES TECHNIQUES

INK - ENCRE

PANTONE® * FORMUL (A)_E

COLOUR No. COULEUR : A-5050-431

- .0910 parts Pantone Reflex Blue
- .1520 parts Pantone Mixing Black
- .7570 parts Pantone Extender

AIM SOLID DENSITY
DENSITÉ TEINTE PLATE VISÉE : 0.75 W/H 0.61 D/S

GRAYNESS - NETTETÉ : N/A

HUE ERROR - DÉVIATION DE : N/A
TEINTE

INK EFFICIENCY : N/A
EFFICACITÉ DE L'ENCRE

DENSITOMETRY / DENSITOMÉTRIE

- CHANNEL-SÉLECTION: YELLOW/JAUNE
- FILTER TYPE DE FILTRES: STATUS T
- FACTEUR n FACTOR: 2.7

* Pantone, Inc.'s check-standard trademark for colour reproduction and colour reproduction materials.

* La marque de Pantone, Inc. de contrôle uniforme pour la reproduction en couleur et les matériaux pour la reproduction en couleur.

CIE CHROMATICITY DIAGRAM(ME) DES CHROMATICITÉS CIE

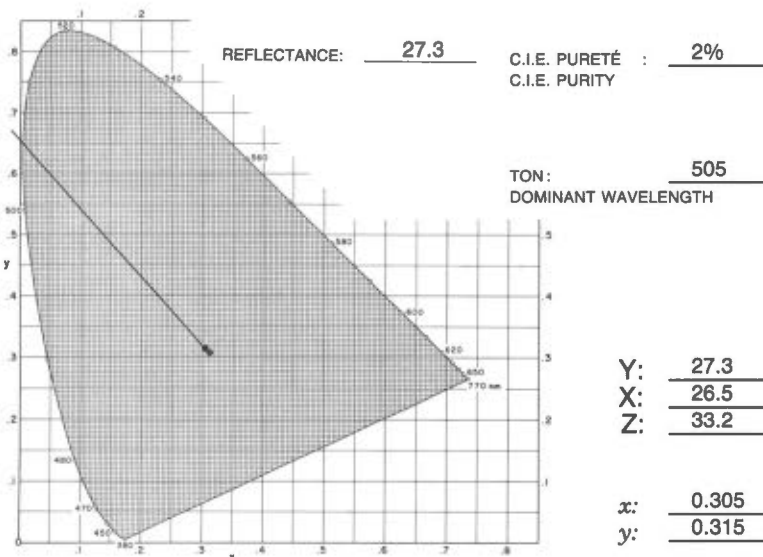

ID. PATCHES BLOCS IDEN.	% SCREEN FRAME	DENSITY DENSITÉ	% PRINT IMPRESSION
A	3	.11	6
B	6	.12	10
C	12	.16	16
D	22	.21	31
E	30	.26	42
F	40	.32	53
G	52	.39	70
H	66	.46	82
I	77	.48	89
J	87	.52	95
M	14	.19	26
N	27	.27	42
O	37	.31	52
P	51	.38	64
SOLID TEINTE PLATE	100	.56	100

PAPER - PAPIER

GRADE / CATÉGORIE: W.S. STANDARD

TYPE: UNCOATED - NON COUCHÉ

REFLECTIVITÉ / REFLECTIVITY: 81%

OPACITÉ / OPACITY: 87%

% CONTRASTE/CONTRAST: 14%

PLATE - PLAQUE

SUBT. - SOUST.

TYPE: NEGATIVE

PRESS - PRESSE

• MEIHLE

• UNIT(É) #: LOWER/INFÉRIEURE

The colour printed here was blended from, and should only be blended from PANTONE Basic Colours obtained from a PANTONE Licensed Printing Ink Manufacturer. Pantone, Inc. assumes no responsibility for the accuracy of the formulas or the colour reproduced.

La couleur ci-imprimée fut et devrait être mélangée seulement à partir des couleurs de base PANTONE obtenues d'un fabricant d'encre autorisé. La compagnie Pantone, Inc. n'assume aucune responsabilité quant à l'exactitude du mélange ou de la couleur obtenue.

RDD - DRD

COLOURS AND SCREENS

COULEURS ET TRAMES

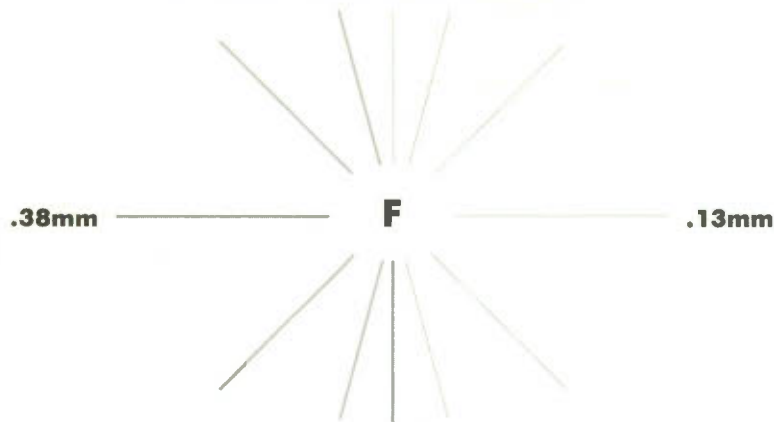

BIANGULAR SCREENS — TRAMES BIANGULÉES

M

6 pt. Triumvirate Roman/Romain	.08mm	
8 pt. Triumvirate Roman/Romain	.13mm	
10 pt. Futura Roman/Romain	.18mm	
12 pt. CG Trade Condensed/Condensé	.25mm	
	.38mm	

N

6 pt. Triumvirate Roman/Romain	.08mm	
8 pt. Futura Roman/Romain	.13mm	
10 pt. CG Trade Condensed/Condensé	.18mm	
12 pt. Cent. Text It./Italique	.25mm	
	.38mm	

O

6 pt. Futura Roman/Romain	.08mm	
8 pt. CG Trade Condensed/Condensé	.13mm	
10 pt. Century Text Italic/Italique	.18mm	
12 pt. Trium. Rom./Romain	.25mm	
	.38mm	

P

6 pt. CG Trade Condensed/Condensé	.08mm	
8 pt. Century Text Italic/Italique	.13mm	
10 pt. Triumvirate Roman/Romain	.18mm	
12 pt. Futura Roman/Romain	.25mm	
	.38mm	

SOLID — TEINTE PLATE

6 pt. Century Text Italic/Italique	.08mm	
8 pt. Triumvirate Roman/Romain	.13mm	
10 pt. Futura Roman/Romain	.18mm	
12 pt. CG Trade Condensed/Condensé	.25mm	
	.38mm	

A

B

C

D

E

F

G

H

I

J

S

TECHNICAL INFORMATION — DONNÉES TECHNIQUES

INK - ENCRE

PANTONE® * FORMUL (A/E)

COLOUR No. COULEUR : A-5050-431

- ___ .0910 parts Pantone Reflex Blue
- ___ .1520 parts Pantone Mixing Black
- ___ .7570 parts Pantone Extender
- ___

AIM SOLID DENSITY
DENSITÉ TEINTE PLATE VISÉE : 0.78 W/H 0.63 D/S

GRAYNESS - NETTETÉ : N/A

HUE ERROR - DÉVIATION DE : N/A
TEINTE

INK EFFICIENCY : N/A
EFFICACITÉ DE L'ENCRE

DENSITOMETRY / DENSITOMÉTRIE

- CHANNEL-SÉLECTION: YELLOW/JAUNE
- FILTER TYPE DE FILTRES: STATUS T
- FACTEUR n FACTOR: 2.7

* Pantone, Inc.'s check-standard trademark for colour reproduction and colour reproduction materials.

* La marque de Pantone, Inc. de contrôle uniforme pour la reproduction en couleur et les matériaux pour la reproduction en couleur.

CIE CHROMATICITY DIAGRAM(ME) DES CHROMATICITÉS CIE

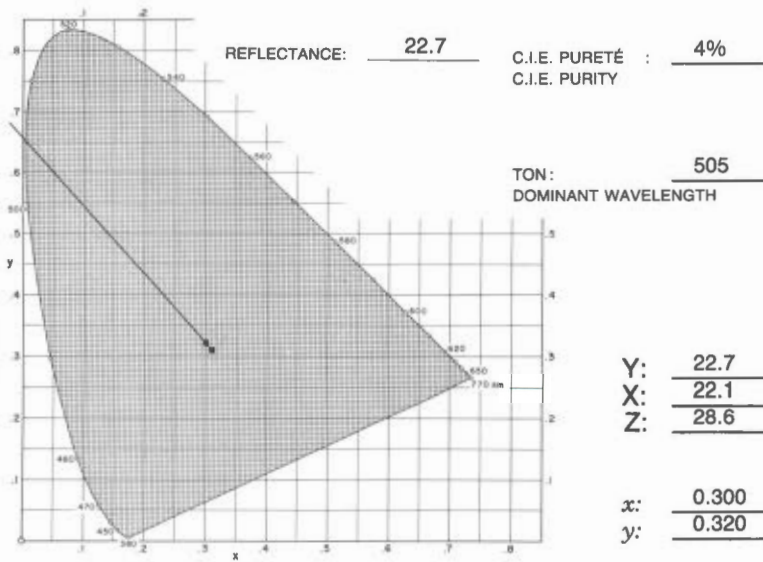

ID. PATCHES BLOCS IDEN.	% SCREEN TRAME	DENSITY DENSITÉ	% PRINT IMPRESSION
A	3	.10	4
B	6	.11	9
C	12	.15	17
D	22	.21	31
E	30	.26	40
F	40	.32	54
G	52	.39	66
H	66	.48	80
I	77	.51	87
J	87	.54	92
M	14	.18	23
N	27	.27	41
O	37	.31	50
P	51	.37	63
SOLID TEINTE PLATE	100	.59	100

PAPER - PAPIER

GRADE / CATÉGORIE: W.S. NEW BRITE

TYPE: UNCOATED - NON COUCHÉ

REFLECTIVITÉ / REFLECTIVITY: 83%

OPACITÉ / OPACITY: 85.5%

% CONTRASTE/CONTRAST: 14%

PLATE - PLAQUE

SUBT. - SOUST.

TYPE: NEGATIVE

PRESS - PRESSE

• MEIHLE

• UNIT(É) #: LOWER/INFÉRIEURE

The colour printed here was blended from, and should only be blended from PANTONE Basic Colours obtained from a PANTONE Licensed Printing Ink Manufacturer. Pantone, Inc. assumes no responsibility for the accuracy of the formulas or the colour reproduced.

La couleur ci-imprimée fut et devrait être mélangée seulement à partir des couleurs de base PANTONE obtenues d'un fabricant d'encre autorisé. La compagnie Pantone, Inc. n'assume aucune responsabilité quant à l'exactitude du mélange ou de la couleur obtenue.

RDD - DRD

COLOURS AND SCREENS

COULEURS ET TRAMES

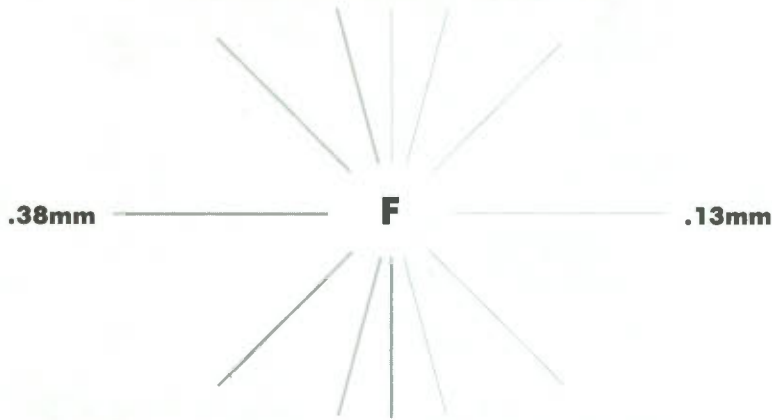

BIANGULAR SCREENS — TRAMES BIANGULÉES

M

6 pt. <i>Century Text Italic/Italique</i>	.06mm	
8 pt. <i>Triumvirate Roman/Romain</i>	.13mm	
10 pt. <i>Futura Roman/Romain</i>	.18mm	
12 pt. <i>CG Trade Condensed/Condensé</i>	.25mm	
	.38mm	

N

6 pt. <i>Triumvirate Roman/Romain</i>	.06mm	
8 pt. <i>Futura Roman/Romain</i>	.13mm	
10 pt. <i>CG Trade Condensed/Condensé</i>	.18mm	
12 pt. <i>Cent. Text It./Italique</i>	.25mm	
	.38mm	

O

6 pt. <i>Futura Roman/Romain</i>	.06mm	
8 pt. <i>CG Trade Condensed/Condensé</i>	.13mm	
10 pt. <i>Century Text Italic/Italique</i>	.18mm	
12 pt. <i>Trium. Rom./Romain</i>	.25mm	
	.38mm	

P

6 pt. <i>CG Trade Condensed/Condensé</i>	.06mm	
8 pt. <i>Century Text Italic/Italique</i>	.13mm	
10 pt. <i>Triumvirate Roman/Romain</i>	.18mm	
12 pt. <i>Futura Roman/Romain</i>	.25mm	
	.38mm	

SOLID — TEINTE PLATE

6 pt. <i>Century Text Italic/Italique</i>	.06mm	
8 pt. <i>Triumvirate Roman/Romain</i>	.13mm	
10 pt. <i>Futura Roman/Romain</i>	.18mm	
12 pt. <i>CG Trade Condensed/Condensé</i>	.25mm	
	.38mm	

A
B
C
D
E
F
G
H
I
J
S

TECHNICAL INFORMATION — DONNÉES TECHNIQUES

INK - ENCRE

PANTONE® * FORMUL (A/E)

— .0910 parts Pantone Reflex Blue
 — .1520 parts Pantone Mixing Black
 — .7570 parts Pantone Extender

COLOUR No. COULEUR : A-5860-431

AIM SOLID DENSITY
 DENSITÉ TEINTE PLATE VISÉE : 0.74 W/H 0.61 D/S

GRAYNESS - NETTETÉ : N/A

HUE ERROR - DÉVIATION DE : N/A
 TEINTE

INK EFFICIENCY : N/A
 EFFICACITÉ DE L'ENCRE

DENSITOMETRY / DENSITOMÉTRIE

- CHANNEL-SÉLECTION: YELLOW/JAUNE
- FILTER TYPE DE FILTRES: STATUS T
- FACTEUR n FACTOR: 2.7

* Pantone, Inc.'s check-standard trademark for colour reproduction and colour reproduction materials.
 * La marque de Pantone, Inc. de contrôle uniforme pour la reproduction en couleur et les matériaux pour la reproduction en couleur.

CIE CHROMATICITY DIAGRAM(ME) DES CHROMATICITÉS CIE

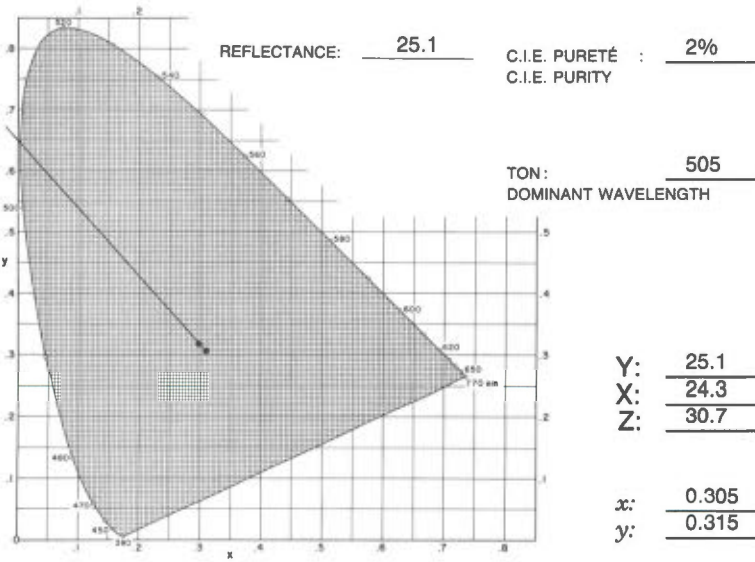

ID. PATCHES BLOCS IDEN.	% SCREEN FRAME	DENSITY DENSITÉ	% PRINT IMPRESSION
A	3	.11	3
B	6	.12	7
C	12	.16	15
D	22	.21	27
E	30	.26	38
F	40	.31	51
G	52	.38	64
H	66	.45	79
I	77	.49	86
J	87	.54	93
M	14	.18	21
N	27	.26	39
O	37	.30	48
P	51	.36	60
SOLID TEINTE PLATE	100	.57	100

PAPER - PAPIER

GRADE / CATÉGORIE: CHART

TYPE: UNCOATED - NON COUCHÉ

REFLECTIVITÉ / REFLECTIVITY: 81%

OPACITÉ / OPACITY: 96.5%

% CONTRASTE/CONTRAST: 14%

PLATE - PLAQUE

SUBT. - SOUST.

TYPE: NEGATIVE

PRESS - PRESSE

• MEIHLE

• UNIT(É) #: LOWER/INFÉRIEURE

The colour printed here was blended from, and should only be blended from PANTONE Basic Colours obtained from a PANTONE Licensed Printing Ink Manufacturer.
 Pantone, Inc. assumes no responsibility for the accuracy of the formulas or the colour reproduced.

La couleur ci-imprimée fut et devrait être mélangée seulement à partir des couleurs de base PANTONE obtenues d'un manufacturier d'encre autorisé.
 La compagnie Pantone, Inc. n'assume aucune responsabilité quant à l'exactitude du mélange ou de la couleur obtenue.

0 1 2 3
8 3 8 5 8
m m m m m

RDD - DRD

COLOURS AND SCREENS

COULEURS ET TRAMES

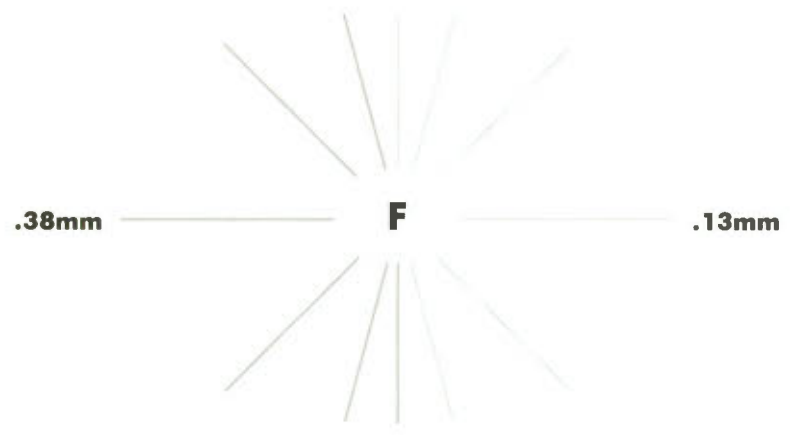

BIANGULAR SCREENS — TRAMES BIANGULÉES

M

<i>6 pt. Triumvirate Roman/Romain</i>	.08mm	
<i>8 pt. Futura Roman/Romain</i>	.13mm	
<i>10 pt. CG Trade Condensed/Condensé</i>	.18mm	
<i>12 pt. Cent. Text It./Italique</i>	.25mm	
	.38mm	

N

<i>6 pt. Triumvirate Roman/Romain</i>	.08mm	
<i>8 pt. Futura Roman/Romain</i>	.13mm	
<i>10 pt. CG Trade Condensed/Condensé</i>	.18mm	
<i>12 pt. Cent. Text It./Italique</i>	.25mm	
	.38mm	

O

<i>6 pt. Futura Roman/Romain</i>	.08mm	
<i>8 pt. CG Trade Condensed/Condensé</i>	.13mm	
<i>10 pt. Century Text Italic/Italique</i>	.18mm	
<i>12 pt. Trium. Rom./Romain</i>	.25mm	
	.38mm	

P

<i>6 pt. CG Trade Condensed/Condensé</i>	.08mm	
<i>8 pt. Century Text Italic/Italique</i>	.13mm	
<i>10 pt. Triumvirate Roman/Romain</i>	.18mm	
<i>12 pt. Futura Roman/Romain</i>	.25mm	
	.38mm	

SOLID — TEINTE PLATE

<i>6 pt. Century Text Italic/Italique</i>	.08mm	
<i>8 pt. Triumvirate Roman/Romain</i>	.13mm	
<i>10 pt. Futura Roman/Romain</i>	.18mm	
<i>12 pt. CG Trade Condensed/Condensé</i>	.25mm	
	.38mm	

A
B
C
D
E
F
G
H
I
J
S

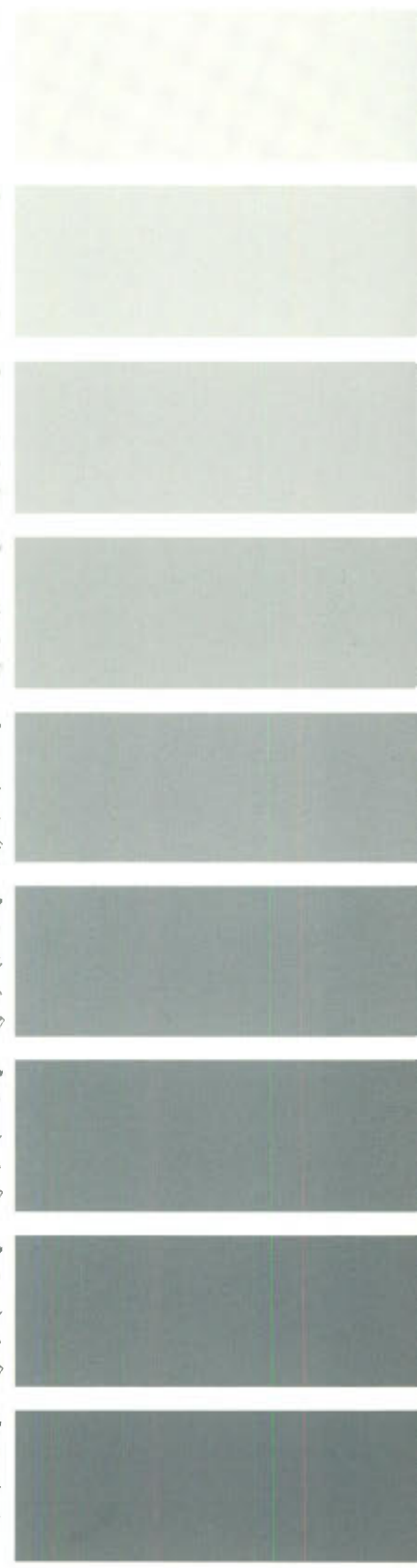

0 0 0 0
8 8 8 7 6
3 5 7 0 5

TECHNICAL INFORMATION — DONNÉES TECHNIQUES

INK - ENCRE

PANTONE® * FORMUL (A)_E

COLOUR No. COULEUR : A-5642-109

- .0300 parts Pantone Process Yellow
- .0490 parts Pantone Process Blue
- .2150 parts Pantone Opaque White
- .0540 parts Pantone Mixing Black
- .6520 parts Pantone White

AIM SOLID DENSITY
DENSITÉ TEINTE PLATE VISÉE : 0.45 W/H 0.42 D/S

GRAYNESS - NETTETÉ : N/A

HUE ERROR - DÉVIATION DE : N/A
TEINTE

INK EFFICIENCY : N/A
EFFICACITÉ DE L'ENCRE

DENSITOMETRY / DENSITOMÉTRIE

- CHANNEL-SÉLECTION: YELLOW/JAUNE
- FILTER TYPE DE FILTRES: STATUS T
- FACTEUR n FACTOR: 2.7

* Pantone, Inc.'s check-standard trademark for colour reproduction and colour reproduction materials.

* La marque de Pantone, Inc. de contrôle uniforme pour la reproduction en couleur et les matériaux pour la reproduction en couleur.

CIE CHROMATICITY DIAGRAM(ME) DES CHROMATICITÉS CIE

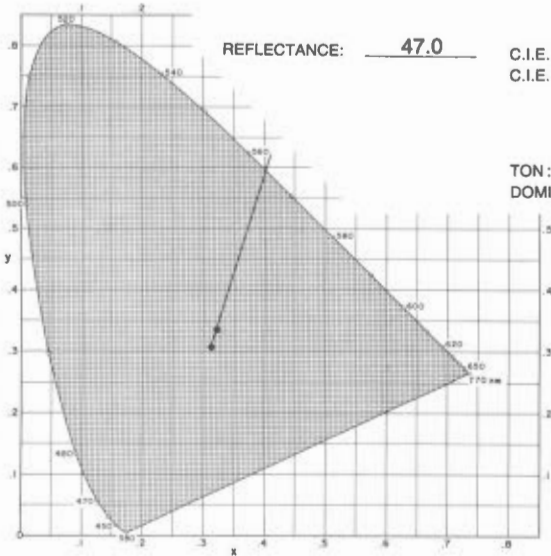

ID. PATCHES BLOCS IDEN.	% SCREEN TRAME	DENSITY DENSITE	% PRINT IMPRESSION
A	3	.10	5
B	6	.11	9
C	12	.14	17
D	22	.17	28
E	30	.22	36
F	40	.24	50
G	52	.27	64
H	66	.32	73
I	77	.35	84
J	87	.37	92
M	14	.14	18
N	27	.20	38
O	37	.23	49
P	51	.27	61
SOLID TEINTE PLATE	100	.40	100

PAPER - PAPIER

GRADE / CATÉGORIE: W.S. STANDARD

TYPE: UNCOATED - NON COUCHÉ

REFLECTIVITÉ / REFLECTIVITY: 83%

OPACITÉ / OPACITY: 87%

% CONTRASTE/CONTRAST: 13%

PLATE - PLAQUE

TYPE: SUBT. - SOUST.

NEGATIVE

PRESS - PRESSE

• MEIHLE

• UNIT(É) #: LOWER/INFÉRIEURE

The colour printed here was blended from, and should only be blended from PANTONE Basic Colours obtained from a PANTONE Licensed Printing Ink Manufacturer. Pantone, Inc. assumes no responsibility for the accuracy of the formulas or the colour reproduced.

La couleur ci-imprimée fut et devrait être mélangée seulement à partir des couleurs de base PANTONE obtenues d'un manufacturier d'encre autorisée. La compagnie Pantone, Inc. n'assume aucune responsabilité quant à l'exactitude du mélange ou de la couleur obtenue.

TECHNICAL INFORMATION — DONNÉES TECHNIQUES

INK - ENCRE

PANTONE® * FORMUL (A/E)

COLOUR No. COULEUR : A-5642-109

- .0300 parts Pantone Process Yellow
- .0490 parts Pantone Process Blue
- .2150 parts Pantone Opaque White
- .0540 parts Pantone Mixing Black
- .6520 parts Pantone White

AIM SOLID DENSITY
DENSITÉ TEINTE PLATE VISÉE : 0.45 W/H 0.42 D/S

GRAYNESS - NETTETÉ : N/A

HUE ERROR - DÉVIATION DE : N/A
TEINTE

INK EFFICIENCY : N/A
EFFICACITÉ DE L'ENCRE

DENSITOMETRY / DENSITOMÉTRIE

- CHANNEL-SÉLECTION: YELLOW/JAUNE
- FILTER TYPE DE FILTRES: STATUS T
- FACTEUR n FACTOR: 2.7

* Pantone, Inc.'s check-standard trademark for colour reproduction and colour reproduction materials.

* La marque de Pantone, Inc. de contrôle uniforme pour la reproduction en couleur et les matériaux pour la reproduction en couleur.

CIE CHROMATICITY DIAGRAM(ME) DES CHROMATICITÉS CIE

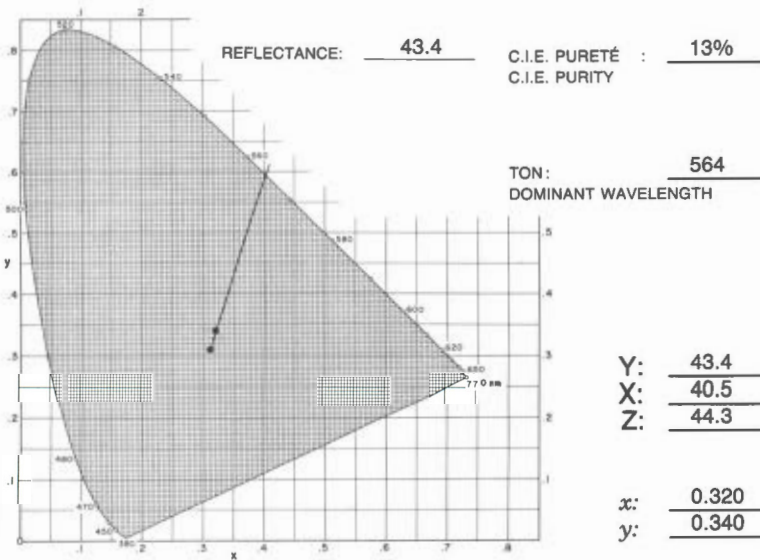

ID. PATCHES BLOCS IDEN.	% SCREEN FRAME	DENSITY DENSITÉ	% PRINT IMPRESSION
A	3	.09	5
B	6	.10	8
C	12	.12	14
D	22	.16	25
E	30	.19	35
F	40	.22	49
G	52	.27	60
H	66	.31	72
I	77	.34	83
J	87	.37	92
M	14	.13	19
N	27	.18	35
O	37	.22	46
P	51	.25	58
SOLID TEINTE PLATE	100	.39	100

PAPER - PAPIER

GRADE / CATÉGORIE: W.S. NEW BRITE

TYPE: UNCOATED - NON COUCHÉ

REFLECTIVITÉ / REFLECTIVITY: 83%

OPACITÉ / OPACITY: 85.5%

% CONTRASTE/CONTRAST: 13%

PLATE - PLAQUE

SUBT. - SOUST.

TYPE: NEGATIVE

PRESS - PRESSE

• MEIHLE

• UNIT(É) #: LOWER/INFÉRIEURE

The colour printed here was blended from, and should only be blended from PANTONE Basic Colours obtained from a PANTONE Licensed Printing Ink Manufacturer. Pantone, Inc. assumes no responsibility for the accuracy of the formulas or the colour reproduced.

La couleur ci- imprimée fut et devrait être mélangée seulement à partir des couleurs de base PANTONE obtenues d'un manufacturier d'encre autorisé. La compagnie Pantone, Inc. n'assume aucune responsabilité quant à l'exactitude du mélange ou de la couleur obtenue.

RDD - DRD

COLOURS AND SCREENS

COULEURS ET TRAMES

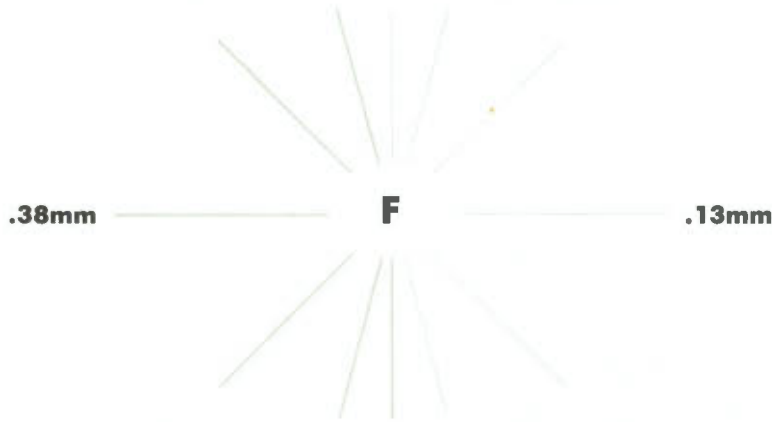

BIANGULAR SCREENS — TRAMES BIANGULÉES

M

<i>6 pt. Futura Roman/Romain</i>	.08mm	
<i>8 pt. Futura Roman/Romain</i>	.13mm	
<i>10 pt. CG Trade Condensed/Condensé</i>	.18mm	
<i>12 pt. Cent. Text It./Italique</i>	.25mm	
<i>14 pt. Futura Roman/Romain</i>	.38mm	

N

<i>6 pt. Futura Roman/Romain</i>	.08mm	
<i>8 pt. Futura Roman/Romain</i>	.13mm	
<i>10 pt. CG Trade Condensed/Condensé</i>	.18mm	
<i>12 pt. Cent. Text It./Italique</i>	.25mm	
<i>14 pt. Futura Roman/Romain</i>	.38mm	

O

<i>6 pt. Futura Roman/Romain</i>	.08mm	
<i>8 pt. CG Trade Condensed/Condensé</i>	.13mm	
<i>10 pt. Century Text It./Italique</i>	.18mm	
<i>12 pt. Trium. Rom./Romain</i>	.25mm	
<i>14 pt. Futura Roman/Romain</i>	.38mm	

P

<i>6 pt. CG Trade Condensed/Condensé</i>	.08mm	
<i>8 pt. Century Text It./Italique</i>	.13mm	
<i>10 pt. Triumvirate Roman/Romain</i>	.18mm	
<i>12 pt. Futura Roman/Romain</i>	.25mm	
<i>14 pt. Futura Roman/Romain</i>	.38mm	

SOLID — TEINTE PLATE

<i>6 pt. Century Text It./Italique</i>	.08mm	
<i>8 pt. Triumvirate Roman/Romain</i>	.13mm	
<i>10 pt. Futura Roman/Romain</i>	.18mm	
<i>12 pt. CG Trade Condensed/Condensé</i>	.25mm	
<i>14 pt. Futura Roman/Romain</i>	.38mm	

A
B
C
D
E
F
G
H
I
J
S

0 0 0 0 0
3 5 7 1 6

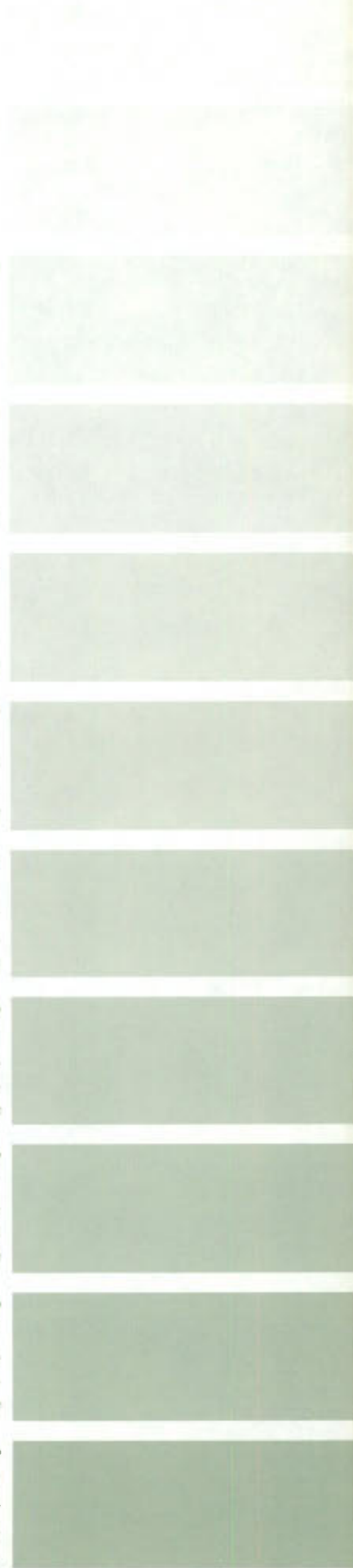

TECHNICAL INFORMATION — DONNÉES TECHNIQUES

INK - ENCRE

PANTONE® * FORMUL (A)
(E)

COLOUR No. COULEUR : A-5642-109

- .0300 parts Pantone Process Yellow
- .0490 parts Pantone Process Blue
- .2150 parts Pantone Opaque White
- .0540 parts Pantone Mixing Black
- .6520 parts Pantone White

AIM SOLID DENSITY
DENSITÉ TEINTE PLATE VISÉE : 0.45 W/H 0.40 D/S

GRAYNESS - NETTETÉ : N/A

HUE ERROR - DÉVIATION DE : N/A
TEINTE

INK EFFICIENCY : N/A
EFFICACITÉ DE L'ENCRE

DENSITOMETRY / DENSITOMÉTRIE

- CHANNEL-SÉLECTION: YELLOW/JAUNE
- FILTER TYPE DE FILTRES: STATUS T
- FACTEUR n FACTOR: 2.7

* Pantone, Inc.'s check-standard trademark for colour reproduction and colour reproduction materials.

* La marque de Pantone, Inc. de contrôle uniforme pour la reproduction en couleur et les matériaux pour la reproduction en couleur.

CIE CHROMATICITY DIAGRAM(ME) DES CHROMATICITÉS CIE

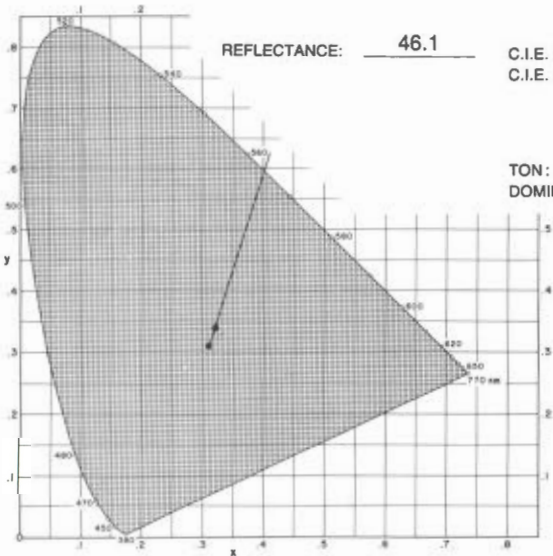

REFLECTANCE: 46.1 C.I.E. PURETÉ : 12%
C.I.E. PURITY

TON: 564
DOMINANT WAVELENGTH

Y: 46.1
X: 42.9
Z: 45.1

x: 0.320
y: 0.340

PAPER - PAPIER

PLATE - PLAQUE

GRADE / CATÉGORIE: CHART

SUBT. - SOUST.

TYPE: UNCOATED - NON COUCHÉ

TYPE: NEGATIVE

REFLECTIVITÉ / REFLECTIVITY: 81%

PRESS - PRESSE

OPACITÉ / OPACITY: 96.5%

• MEIHLE

% CONTRASTE/CONTRAST: 15%

• UNIT(É) #: LOWER/INFÉRIEURE

ID. PATCHES BLOCS IDEN.	% SCREEN TRAME	DENSITY DENSITÉ	% PRINT IMPRESSION
A	3	.10	5
B	6	.11	8
C	12	.13	14
D	22	.16	24
E	30	.19	34
F	40	.22	45
G	52	.27	58
H	66	.31	72
I	77	.34	80
J	87	.36	88
M	14	.14	18
N	27	.19	35
O	37	.22	44
P	51	.26	55
SOLID TEINTE PLATE	100	.40	100

The colour printed here was blended from, and should only be blended from PANTONE Basic Colours obtained from a PANTONE Licensed Printing Ink Manufacturer.
Pantone, Inc. assumes no responsibility for the accuracy of the formulas or the colour reproduced.

La couleur ci-imprimée fut et devrait être mélangée seulement à partir des couleurs de base PANTONE obtenues d'un fabricant d'encre autorisé.
La compagnie Pantone, Inc. n'assume aucune responsabilité quant à l'exactitude du mélange ou de la couleur obtenue.

SURVEYS AND MAPPING BRANCH
DIRECTION DES LEVÉS ET DE LA CARTOGRAPHIE

AVRIL 1987
APRIL

RDD - DRD

COLOURS AND SCREENS

COULEURS ET TRAMES

.38mm

F

.13mm

BIANGULAR SCREENS — TRAMES BIANGULÉES

M

.08mm
.13mm
.18mm
.25mm
.38mm

N

.08mm
.13mm
.18mm
.25mm
.38mm

O

.08mm
.13mm
.18mm
.25mm
.38mm

P

.08mm
.13mm
.18mm
.25mm
.38mm

SOLID — TEINTE PLATE

4 pt. Century Text Italic/Italique
8 pt. Trlumvirate Roman/Romain
10 pt. Futura Roman/Romain
12 pt. CG Trade Condensed/Condense

.08mm
.13mm
.18mm
.25mm
.38mm

A

B

C

D

E

F

G

H

I

J

S

TECHNICAL INFORMATION — DONNÉES TECHNIQUES

INK - ENCRE

PANTONE® * FORMUL (A/E)

COLOUR No. COULEUR : A-5690-57003

- .0590 parts Pantone Process Yellow
- .0330 parts Pantone Rubine Red
- .0330 parts Pantone Process Blue
- .0250 parts Pantone Mixing Black
- .8500 parts Pantone Extender

AIM SOLID DENSITY
DENSITÉ TEINTE PLATE VISÉE : 0.44 W/H 0.40 D/S

GRAYNESS - NETTETÉ : N/A

HUE ERROR - DÉVIATION DE : N/A
TEINTE

INK EFFICIENCY : N/A
EFFICACITÉ DE L'ENCRE

DENSITOMETRY / DENSITOMÉTRIE

- CHANNEL-SÉLECTION: YELLOW/JAUNE
- FILTER TYPE DE FILTRES: STATUS T
- FACTEUR n FACTOR: 2.7

* Pantone, Inc.'s check-standard trademark for colour reproduction and colour reproduction materials.
* La marque de Pantone, Inc. de contrôle uniforme pour la reproduction en couleur et les matériaux pour la reproduction en couleur.

CIE CHROMATICITY DIAGRAM(ME) DES CHROMATICITÉS CIE

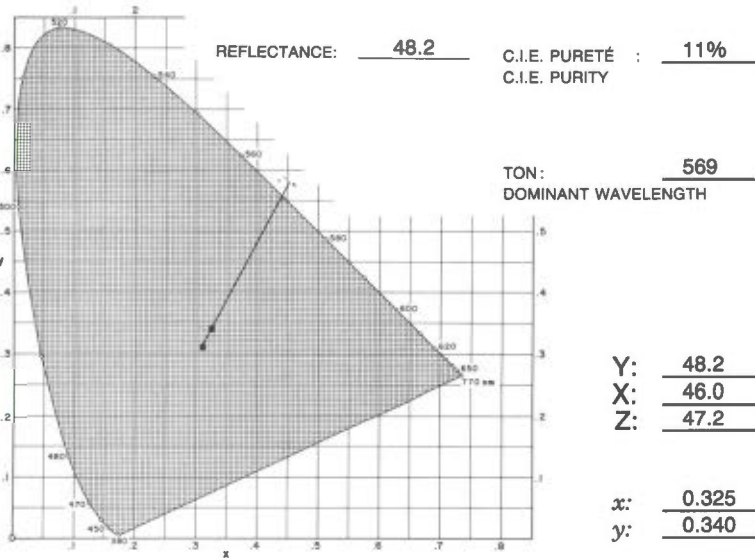

ID. PATCHES BLOCS IDEN.	% SCREEN TRAME	DENSITY DENSITÉ	% PRINT IMPRESSION
A	3	.09	1
B	6	.10	4
C	12	.13	14
D	22	.16	24
E	30	.19	35
F	40	.22	48
G	52	.27	58
H	66	.30	72
I	77	.33	82
J	87	.36	89
M	14	.13	16
N	27	.18	33
O	37	.21	44
P	51	.25	55
SOLID TEINTE PLATE	100	.39	100

PAPER - PAPIER

GRADE / CATÉGORIE: W.S. STANDARD

TYPE: UNCOATED - NON COUCHÉ

REFLECTIVITÉ / REFLECTIVITY: 81%

OPACITÉ / OPACITY: 87%

% CONTRASTE/CONTRAST: 15%

PLATE - PLAQUE

SUBT. - SOUST.

TYPE: NEGATIVE

PRESS - PRESSE

• MEIHLE

• UNIT(É) #: LOWER/INFÉRIEURE

The colour printed here was blended from, and should only be blended from PANTONE Basic Colours obtained from a PANTONE Licensed Printing Ink Manufacturer.
Pantone, Inc. assumes no responsibility for the accuracy of the formulas or the colour reproduced.

La couleur ci-imprimée fut et devrait être mélangée seulement à partir des couleurs de base PANTONE obtenues d'un manufacturier d'encre autorisé.
La compagnie Pantone, Inc. n'assume aucune responsabilité quant à l'exactitude du mélange ou de la couleur obtenue.

RDD - DRD

COLOURS AND SCREENS

COULEURS ET TRAMES



BIANGULAR SCREENS — TRAMES BIANGULÉES

M

6 pt. Century Text Italic/Italique	.08mm	
8 pt. Futura Roman/Romain	.13mm	
10 pt. CG Trade Condensed/Condensé	.18mm	
12 pt. Century Text Italic/Italique	.25mm	
	.38mm	

N

6 pt. Century Text Italic/Italique	.08mm	
8 pt. Futura Roman/Romain	.13mm	
10 pt. CG Trade Condensed/Condensé	.18mm	
12 pt. Century Text Italic/Italique	.25mm	
	.38mm	

O

6 pt. Century Text Italic/Italique	.08mm	
8 pt. CG Trade Condensed/Condensé	.13mm	
10 pt. Century Text Italic/Italique	.18mm	
12 pt. Trium. Rom./Romain	.25mm	
	.38mm	

P

6 pt. CG Trade Condensed/Condensé	.08mm	
8 pt. Century Text Italic/Italique	.13mm	
10 pt. Triumvirate Roman/Romain	.18mm	
12 pt. Futura Roman/Romain	.25mm	
	.38mm	

SOLID — TEINTE PLATE

6 pt. Century Text Italic/Italique	.08mm	
8 pt. Triumvirate Roman/Romain	.13mm	
10 pt. Futura Roman/Romain	.18mm	
12 pt. CG Trade Condensed/Condensé	.25mm	
	.38mm	

A

B

C

D

E

F

G

H

I

J

S

TECHNICAL INFORMATION — DONNÉES TECHNIQUES

INK - ENCRE

PANTONE® * FORMUL (A/E)

COLOUR No. COULEUR : A-5690-57003

- .0590 parts Pantone Process Yellow
- .0330 parts Pantone Rubine Red
- .0330 parts Pantone Process Blue
- .0250 parts Pantone Mixing Black
- .8500 parts Pantone Extender

AIM SOLID DENSITY
DENSITÉ TEINTE PLATE VISÉE : 0.45 W/H 0.41 D/S

GRAYNESS - NETTETÉ : N/A

HUE ERROR - DÉVIATION DE : N/A
TEINTE

INK EFFICIENCY : N/A
EFFICACITÉ DE L'ENCRE

DENSITOMETRY / DENSITOMÉTRIE

- CHANNEL-SÉLECTION: YELLOW/JAUNE
- FILTER TYPE DE FILTRES: STATUS T
- FACTEUR n FACTOR: 2.7

* Pantone, Inc.'s check-standard trademark for colour reproduction and colour reproduction materials.

* La marque de Pantone, Inc. de contrôle uniforme pour la reproduction en couleur et les matériaux pour la reproduction en couleur.

CIE CHROMATICITY DIAGRAM(ME) DES CHROMATICITÉS CIE

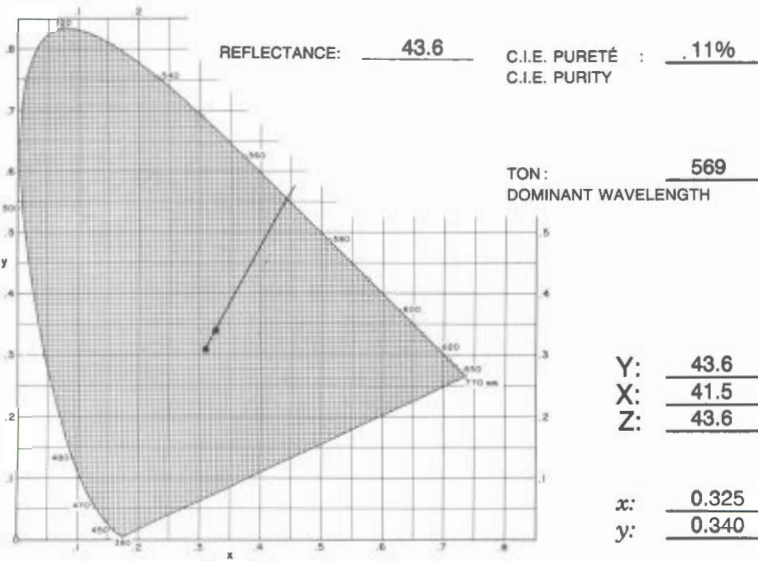

ID. PATCHES BLOCS IDEN.	% SCREEN TRAME	DENSITY DENSITÉ	% PRINT IMPRESSION
A	3	.09	2
B	6	.10	6
C	12	.12	11
D	22	.16	22
E	30	.19	34
F	40	.22	45
G	52	.27	57
H	66	.31	71
I	77	.35	80
J	87	.37	90
M	14	.13	16
N	27	.18	33
O	37	.21	46
P	51	.25	55
SOLID TEINTE PLATE	100	.41	100

PAPER - PAPIER

GRADE / CATÉGORIE: W.S. NEW BRITE

TYPE: UNCOATED - NON COUCHÉ

REFLECTIVITÉ / REFLECTIVITY: 83%

OPACITÉ / OPACITY: 85.5%

% CONTRASTE/CONTRAST: 15%

PLATE - PLAQUE

SUBT. - SOUST.

TYPE: NEGATIVE

PRESS - PRESSE

• MEIHLE

• UNIT(É) #: LOWER/INFÉRIEURE

The colour printed here was blended from, and should only be blended from PANTONE Basic Colours obtained from a PANTONE Licensed Printing Ink Manufacturer. Pantone, Inc. assumes no responsibility for the accuracy of the formulas or the colour reproduced.

La couleur ci-imprimée fut et devrait être mélangée seulement à partir des couleurs de base PANTONE obtenues d'un manufacturier d'encre autorisé. La compagnie Pantone, Inc. n'assume aucune responsabilité quant à l'exactitude du mélange ou de la couleur obtenue.

RDD - DRD

COLOURS AND SCREENS

COULEURS ET TRAMES

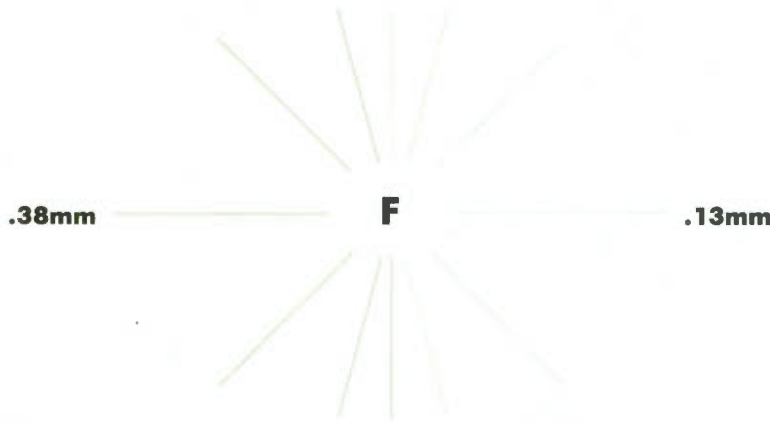

BIANGULAR SCREENS — TRAMES BIANGULÉES

M

<i>6 pt. Century Text Italic/Italique</i>	.08mm	
<i>8 pt. Futura Roman/Romain</i>	.13mm	
<i>10 pt. CG Trade Condensed/Condensé</i>	.18mm	
<i>12 pt. Cent. Text Italic/Italique</i>	.25mm	
	.38mm	

N

<i>6 pt. Century Text Italic/Italique</i>	.08mm	
<i>8 pt. Futura Roman/Romain</i>	.13mm	
<i>10 pt. CG Trade Condensed/Condensé</i>	.18mm	
<i>12 pt. Cent. Text Italic/Italique</i>	.25mm	
	.38mm	

O

<i>6 pt. Century Text Italic/Italique</i>	.08mm	
<i>8 pt. CG Trade Condensed/Condensé</i>	.13mm	
<i>10 pt. Century Text Italic/Italique</i>	.18mm	
<i>12 pt. Trium. Rom./Romain</i>	.25mm	
	.38mm	

P

<i>6 pt. CG Trade Condensed/Condensé</i>	.08mm	
<i>8 pt. Century Text Italic/Italique</i>	.13mm	
<i>10 pt. Triumvirate Roman/Romain</i>	.18mm	
<i>12 pt. Futura Roman/Romain</i>	.25mm	
	.38mm	

SOLID — TEINTE PLATE

<i>6 pt. Century Text Italic/Italique</i>	.08mm	
<i>8 pt. Triumvirate Roman/Romain</i>	.13mm	
<i>10 pt. Futura Roman/Romain</i>	.18mm	
<i>12 pt. CG Trade Condensed/Condensé</i>	.25mm	
	.38mm	

A

B

C

D

E

F

G

H

I

J

S

TECHNICAL INFORMATION — DONNÉES TECHNIQUES

INK - ENCRE

PANTONE® * FORMUL (A/E)

COLOUR No. COULEUR : A-5700-107

AIM SOLID DENSITY
DENSITÉ TEINTE PLATE VISÉE : 0.67 W/H 0.60 D/S

GRAYNESS - NETTETÉ : N/A

HUE ERROR - DÉVIATION DE : N/A
TEINTE

INK EFFICIENCY : N/A
EFFICACITÉ DE L'ENCRE

DENSITOMETRY / DENSITOMÉTRIE

- CHANNEL-SÉLECTION: YELLOW/JAUNE
- FILTER TYPE DE FILTRES: STATUS T
- FACTEUR n FACTOR: 2.7

* Pantone, Inc.'s check-standard trademark for colour reproduction and colour reproduction materials.
* La marque de Pantone, Inc. de contrôle uniforme pour la reproduction en couleur et les matériaux pour la reproduction en couleur.

CIE CHROMATICITY DIAGRAM(ME) DES CHROMATICITÉS CIE

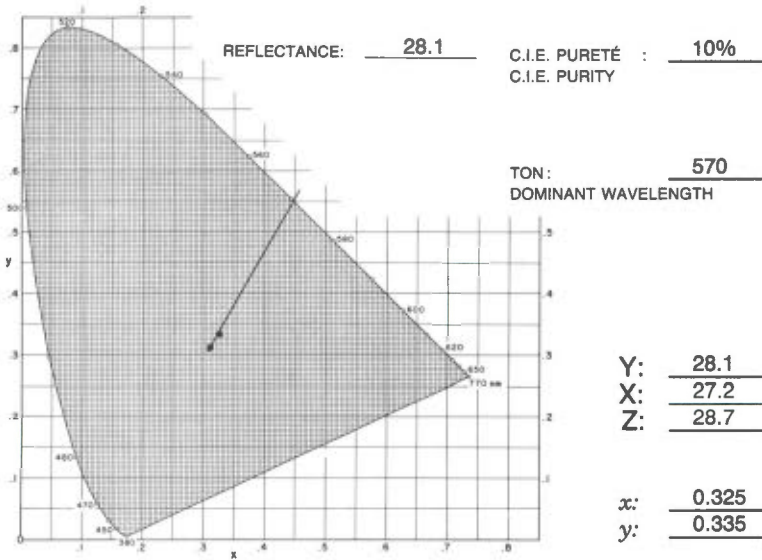

ID. PATCHES BLOCS IDEN.	% SCREEN TRAME	DENSITY DENSITÉ	% PRINT IMPRESSION
A	3	.10	3
B	6	.12	6
C	12	.15	13
D	22	.19	23
E	30	.25	33
F	40	.30	47
G	52	.38	61
H	66	.46	75
I	77	.52	84
J	87	.57	92
M	14	.16	16
N	27	.24	35
O	37	.30	43
P	51	.36	56
SOLID TEINTE PLATE	100	.62	100

PAPER - PAPIER

GRADE / CATÉGORIE: W.S. STANDARD

TYPE: UNCOATED - NON COUCHÉ

REFLECTIVITÉ / REFLECTIVITY: 81%

OPACITÉ / OPACITY: 87%

% CONTRASTE/CONTRAST: 16%

PLATE - PLAQUE

SUBT. - SOUST.

TYPE: NEGATIVE

PRESS - PRESSE

• MEIHLE

• UNIT(É) #: LOWER/INFÉRIEURE

The colour printed here was blended from, and should only be blended from PANTONE Basic Colours obtained from a PANTONE Licensed Printing Ink Manufacturer.
Pantone, Inc. assumes no responsibility for the accuracy of the formulas or the colour reproduced.

La couleur ci- imprimée fut et devrait être mélangée seulement à partir des couleurs de base PANTONE obtenues d'un fabricant d'encre autorisé.
La compagnie Pantone, Inc. n'assume aucune responsabilité quant à l'exactitude du mélange ou de la couleur obtenue.

RDD - DRD

COLOURS AND SCREENS

COULEURS ET TRAMES

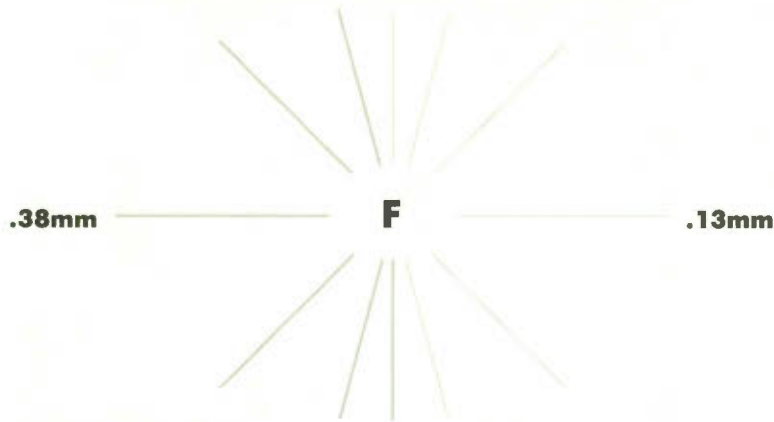

BIANGULAR SCREENS — TRAMES BIANGULÉES

M

6 pt. Triumvirate Roman/Romain
8 pt. Futura Roman/Romain
10 pt. Futura Roman/Romain
12 pt. CG Trade Condensed/Condensé

.08mm
.13mm
.18mm
.25mm
.38mm

N

6 pt. Triumvirate Roman/Romain
8 pt. Futura Roman/Romain
10 pt. CG Trade Condensed/Condensé
12 pt. Cent. Text It./Italique

.08mm
.13mm
.18mm
.25mm
.38mm

O

6 pt. Futura Roman/Romain
8 pt. CG Trade Condensed/Condensé
10 pt. Century Text It./Italique
12 pt. Trium. Rom./Romain

.08mm
.13mm
.18mm
.25mm
.38mm

P

6 pt. CG Trade Condensed/Condensé
8 pt. Century Text It./Italique
10 pt. Triumvirate Roman/Romain
12 pt. Futura Roman/Romain

.08mm
.13mm
.18mm
.25mm
.38mm

SOLID — TEINTE PLATE

6 pt. Century Text It./Italique
8 pt. Triumvirate Roman/Romain
10 pt. Futura Roman/Romain
12 pt. CG Trade Condensed/Condensé

.08mm
.13mm
.18mm
.25mm
.38mm

A
B
C
D
E
F
G
H
I
J
S

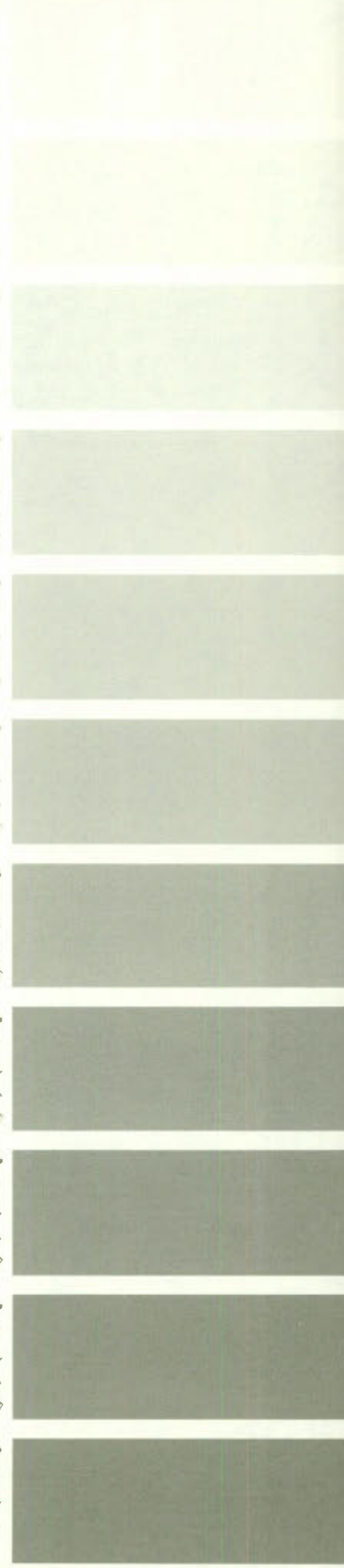

TECHNICAL INFORMATION — DONNÉES TECHNIQUES

INK - ENCRE

PANTONE® * FORMUL (A/E)

COLOUR No. COULEUR : A-5700-107

AIM SOLID DENSITY
DENSITÉ TEINTE PLATE VISÉE : 0.65 W/H 0.59 D/S

GRAYNESS - NETTETÉ : N/A

HUE ERROR - DÉVIATION DE : N/A
TEINTE

INK EFFICIENCY : N/A
EFFICACITÉ DE L'ENCRE

DENSITOMETRY / DENSITOMÉTRIE

- CHANNEL-SÉLECTION: YELLOW/JAUNE
- FILTER TYPE DE FILTRES: STATUS T
- FACTEUR n FACTOR: 2.7

* Pantone, Inc.'s check-standard trademark for colour reproduction and colour reproduction materials.

* La marque de Pantone, Inc. de contrôle uniforme pour la reproduction en couleur et les matériaux pour la reproduction en couleur.

CIE CHROMATICITY DIAGRAM(ME) DES CHROMATICITÉS CIE

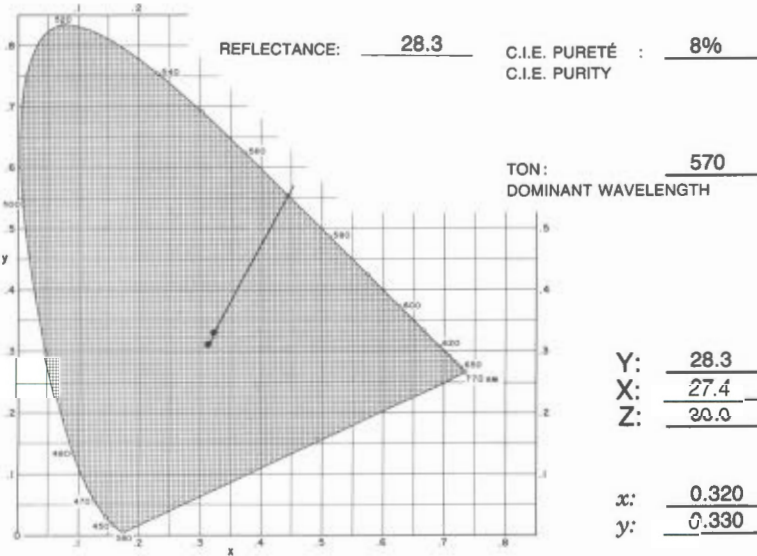

PAPER - PAPIER

GRADE / CATÉGORIE: W.S. NEW BRITE

TYPE: UNCOATED - NON COUCHÉ

REFLECTIVITÉ / REFLECTIVITY: 83%

OPACITÉ / OPACITY: 85.5%

% CONTRASTE/CONTRAST: 17%

PLATE - PLAQUE

TYPE: SUBT. - SOUST.

TYPE: NEGATIVE

PRESS - PRESSE

• MEHLE

• UNIT(É) #: LOWER/INFÉRIEURE

ID. PATCHES BLOCS IDEN.	% SCREEN FRAME	DENSITY DENSITÉ	% PRINT IMPRESSION
A	3	.09	3
B	6	.10	6
C	12	.13	13
D	22	.18	22
E	30	.22	32
F	40	.28	45
G	52	.35	57
H	66	.43	74
I	77	.49	84
J	87	.54	91
M	14	.15	17
N	27	.23	36
O	37	.28	44
P	51	.34	56
SOLID TEINTE PLATE	100	.59	100

The colour printed here was blended from, and should only be blended from PANTONE Basic Colours obtained from a PANTONE Licensed Printing Ink Manufacturer. Pantone, Inc. assumes no responsibility for the accuracy of the formulas or the colour reproduced.

La couleur ci-imprimée fut et devrait être mélangée seulement à partir des couleurs de base PANTONE obtenues d'un fabricant d'encre autorisé. La compagnie Pantone, Inc. n'assume aucune responsabilité quant à l'exactitude du mélange ou de la couleur obtenue.

TECHNICAL INFORMATION — DONNÉES TECHNIQUES

INK - ENCRE

PANTONE® * FORMUL (A/E)

COLOUR No. COULEUR : A-0101-101

— 1.000 parts Pantone Carbon Black

AIM SOLID DENSITY
DENSITÉ TEINTE PLATE VISÉE : 1.19 W/H 1.08 D/S

GRAYNESS - NETTETÉ : 98%

HUE ERROR - DÉVIATION DE : 50%
TEINTE

INK EFFICIENCY : 1%
EFFICACITÉ DE L'ENCRE

DENSITOMETRY / DENSITOMÉTRIE

• CHANNEL-SÉLECTION: YELLOW/JAUNE

• FILTER TYPE DE FILTRES: STATUS T

• FACTEUR n FACTOR: 2.7

* Pantone, Inc.'s check-standard trademark for colour reproduction and colour reproduction materials.

* La marque de Pantone, Inc. de contrôle uniforme pour la reproduction en couleur et les matériaux pour la reproduction en couleur.

CIE CHROMATICITY DIAGRAM(ME) DES CHROMATICITÉS CIE

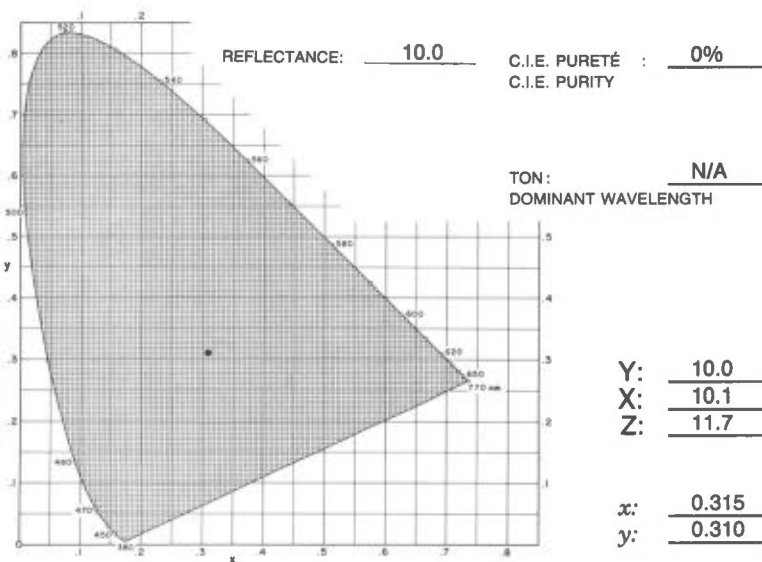

ID. PATCHES BLOCS IDEN.	% SCREEN TRAME	DENSITY DENSITÉ	% PRINT IMPRESSION
A	3	.14	6
B	6	.16	11
C	12	.20	18
D	22	.28	27
E	30	.35	36
F	40	.43	46
G	52	.55	51
H	66	.70	73
I	77	.83	84
J	87	.87	91
M	14	.25	21
N	27	.37	38
O	37	.45	47
P	51	.55	58
SOLID TEINTE PLATE	100	1.05	100

PAPER - PAPIER

GRADE / CATÉGORIE: W.S. STANDARD

TYPE: UNCOATED - NON COUCHÉ

REFLECTIVITÉ / REFLECTIVITY: 81%

OPACITÉ / OPACITY: 87%

% CONTRASTE/CONTRAST: 21%

PLATE - PLAQUE

SUBT. - SOUST.

TYPE: NEGATIVE

PRESS - PRESSE

• MEIHLE

• UNIT(É) #: LOWER/INFÉRIEURE

The colour printed here was blended from, and should only be blended from PANTONE Basic Colours obtained from a PANTONE Licensed Printing Ink Manufacturer. Pantone, Inc. assumes no responsibility for the accuracy of the formulas or the colour reproduced.

La couleur ci-imprimée fut et devrait être mélangée seulement à partir des couleurs de base PANTONE obtenues d'un fabricant d'encre autorisé. La compagnie Pantone, Inc. n'assume aucune responsabilité quant à l'exactitude du mélange ou de la couleur obtenue.

0 1 2 3
8 3 8 5 8
m m m m m

COLOUR NO.
No. DE COULEUR 101

RDD - DRD

COLOURS AND SCREENS

COULEURS ET TRAMES

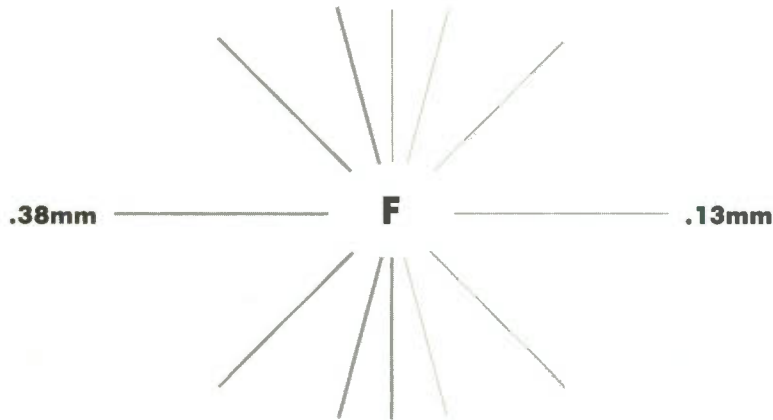

BIANGULAR SCREENS — TRAMES BIANGULÉES

M

E.g. Century Text Italic/Italique
8 pt. Triumvirate Roman/Romain
10 pt. Futura Roman/Romain
12 pt. CG Trade Condensed/Condensé



N

6 pt. Triumvirate Roman/Romain
8 pt. Futura Roman/Romain
10 pt. CG Trade Condensed/Condensé
12 pt. *Cent. Text It./Italique*



O

6 pt. Futura Roman/Romain
8 pt. CG Trade Condensed/Condensé
10 pt. *Century Text Italic/Italique*
12 pt. Trium. Rom./Romain



P

6 pt. CG Trade Condensed/Condensé
8 pt. *Century Text Italic/Italique*
10 pt. Triumvirate Roman/Romain
12 pt. Futura Roman/Romain



SOLID — TEINTE PLATE

6 pt. *Century Text Italic/Italique*
8 pt. Triumvirate Roman/Romain
10 pt. Futura Roman/Romain
12 pt. CG Trade Condensed/Condensé



A

B

C

D

E

F

G

H

I

J

S

0 0 0 0
8 8 8 8
m m m m

TECHNICAL INFORMATION — DONNÉES TECHNIQUES

INK - ENCRE

PANTONE® * FORMUL (A/E)

COLOUR No. COULEUR : A-0101-101

— 1.000 parts Pantone Carbon Black

AIM SOLID DENSITY
DENSITÉ TEINTE PLATE VISÉE : 1.19 W/H 1.10 D/S

GRAYNESS - NETTETÉ : 98%

HUE ERROR - DÉVIATION DE : 50%
TEINTE

INK EFFICIENCY : 1%
EFFICACITÉ DE L'ENCRE

DENSITOMETRY / DENSITOMÉTRIE

• CHANNEL-SÉLECTION: VISUAL

• FILTER TYPE DE FILTRES: STATUS T

• FACTEUR n FACTOR: 2.7

* Pantone, Inc.'s check-standard trademark for colour reproduction and colour reproduction materials.

* La marque de Pantone, Inc. de contrôle uniforme pour la reproduction en couleur et les matériaux pour la reproduction en couleur.

CIE CHROMATICITY DIAGRAM(ME) DES CHROMATICITÉS CIE

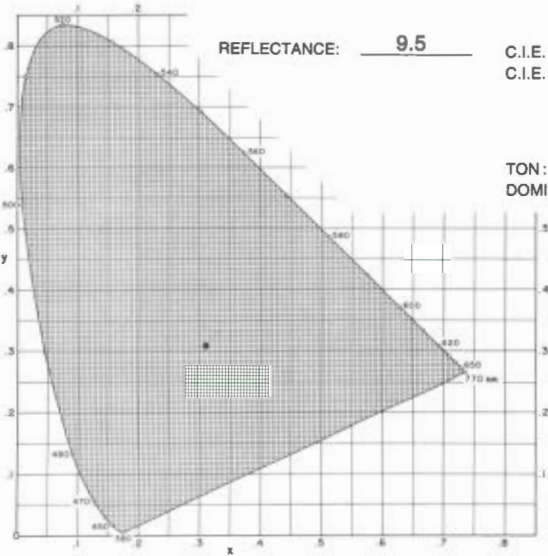

REFLECTANCE: 9.5 C.I.E. PURETÉ : 0%
C.I.E. PURITY

TON: N/A
DOMINANT WAVELENGTH

Y: 9.5
X: 9.6
Z: 11.4

x: 0.315
y: 0.310

PAPER - PAPIER

GRADE / CATÉGORIE: W.S. NEW BRITE

TYPE: UNCOATED - NON COUCHÉ

REFLECTIVITÉ / REFLECTIVITY: 89%

OPACITÉ / OPACITY: 85.5%

% CONTRASTE/CONTRAST: 18%

PLATE - PLAQUE

TYPE: SUBT. - SOUST.

TYPE: NEGATIVE

PRESS - PRESSE

• MEIHLE

• UNIT(É) #: LOWER/INFÉRIEURE

ID. PATCHES BLOCS IDEN.	% SCREEN TRAME	DENSITY DENSITÉ	% PRINT IMPRESSION
A	3	.09	7
B	6	.13	13
C	12	.17	19
D	22	.27	31
E	30	.35	42
F	40	.44	54
G	52	.59	68
H	66	.73	71
I	77	.84	91
J	87	.91	94
M	14	.24	28
N	27	.38	44
O	37	.46	53
P	51	.58	67
SOLID TEINTE PLATE	100	1.02	100

The colour printed here was blended from, and should only be blended from PANTONE Basic Colours obtained from a PANTONE Licensed Printing Ink Manufacturer. Pantone, Inc. assumes no responsibility for the accuracy of the formulas or the colour reproduced.

La couleur ci-imprimée fut et devrait être mélangée seulement à partir des couleurs de base PANTONE obtenues d'un fabricant d'encre autorisé. La compagnie Pantone, Inc. n'assume aucune responsabilité quant à l'exactitude du mélange ou de la couleur obtenue.

SURVEYS AND MAPPING BRANCH
DIRECTION DES LEVÉS ET DE LA CARTOGRAPHIE

AVRIL 1987
APRIL 1987

TECHNICAL INFORMATION — DONNÉES TECHNIQUES

INK - ENCRE

PANTONE® * FORMUL (A)
(E)

COLOUR No. COULEUR : A-0101-101

—1.000 parts Pantone Carbon Black

AIM SOLID DENSITY
DENSITÉ TEINTE PLATE VISÉE : 1.20 W/H 1.11 D/S

GRAYNESS - NETTETÉ : 97%

HUE ERROR - DÉVIATION DE : 67%
TEINTE

INK EFFICIENCY : 2%
EFFICACITÉ DE L'ENCRE

DENSITOMETRY / DENSITOMÉTRIE

• CHANNEL-SÉLECTION: YELLOW/JAUNE

• FILTER TYPE DE FILTRES: STATUS T

• FACTEUR n FACTOR: 2.7

* Pantone, Inc.'s check-standard trademark for colour reproduction and colour reproduction materials.
* La marque de Pantone, Inc. de contrôle uniforme pour la reproduction en couleur et les matériaux pour la reproduction en couleur.

CIE CHROMATICITY DIAGRAM(ME) DES CHROMATICITÉS CIE

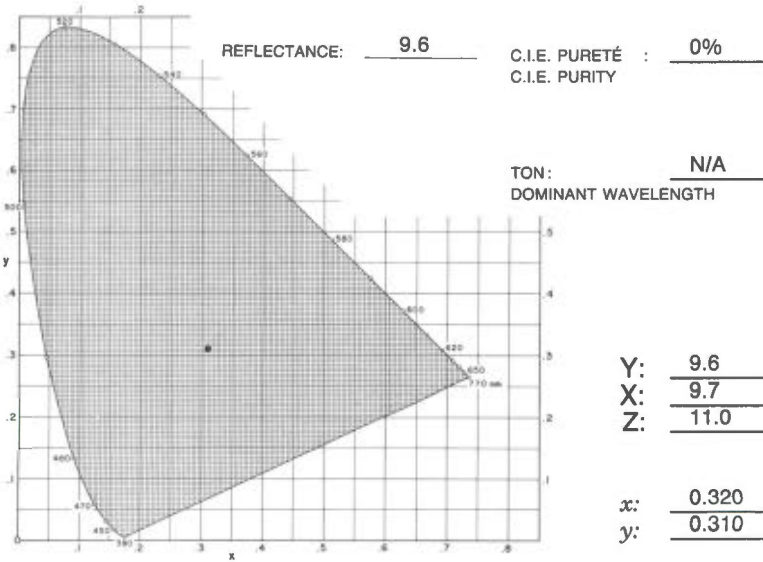

ID. PATCHES BLOCS IDEN.	% SCREEN FRAME	DENSITY DENSITÉ	% PRINT IMPRESSION
A	3	.13	6
B	6	.16	9
C	12	.21	15
D	22	.28	25
E	30	.36	34
F	40	.45	44
G	52	.59	60
H	66	.75	72
I	77	.87	83
J	87	.96	91
M	14	.26	23
N	27	.38	37
O	37	.46	45
P	51	.58	59
SOLID TEINTE PLATE	100	1.09	100

PAPER - PAPIER

GRADE / CATÉGORIE: CHART

TYPE: UNCOATED - NON COUCHÉ

REFLECTIVITÉ / REFLECTIVITY: 81%

OPACITÉ / OPACITY: 96.5

% CONTRASTE/CONTRAST: 20%

PLATE - PLAQUE

SUBT. - SOUST.

TYPE: NEGATIVE

PRESS - PRESSE

• MEIHLE

• UNIT(É) #: LOWER/INFÉRIEURE

The colour printed here was blended from, and should only be blended from PANTONE Basic Colours obtained from a PANTONE Licensed Printing Ink Manufacturer.
Pantone, Inc. assumes no responsibility for the accuracy of the formulas or the colour reproduced.

La couleur ci-imprimée fut et devrait être mélangée seulement à partir des couleurs de base PANTONE obtenues d'un fabricant d'encre autorisé.
La compagnie Pantone, Inc. n'assume aucune responsabilité quant à l'exactitude du mélange ou de la couleur obtenue.

PROCESS COLOURS - COULEURS QUADRICHIQUES

Colour No. Couleur

Name/Nom

4822 (111)
C-4970 (125)
5732 (165)

Cyan Process
Magenta Process
Yellow Process

TECHNICAL INFORMATION — DONNÉES TECHNIQUES

INK - ENCRE

PANTONE® * FORMUL (A/E)

COLOUR No. COULEUR : 4822-111

—1.000 parts Pantone Phtalo Cyanine Blue

AIM SOLID DENSITY
DENSITÉ TEINTE PLATE VISÉE : 1.10 W/H 0.98 D/S

GRAYNESS - NETTETÉ : 12.1%

HUE ERROR - DÉVIATION DE : 27.7%
TEINTE

INK EFFICIENCY : 75.0%
EFFICACITÉ DE L'ENCRE

DENSITOMETRY / DENSITOMÉTRIE

- CHANNEL-SÉLECTION: CYAN
- FILTER TYPE DE FILTRES: STATUS T
- FACTEUR n FACTOR: 2.7

* Pantone, Inc.'s check-standard trademark for colour reproduction and colour reproduction materials.

* La marque de Pantone, Inc. de contrôle uniforme pour la reproduction en couleur et les matériaux pour la reproduction en couleur.

CIE CHROMATICITY DIAGRAM(ME) DES CHROMATICITÉS CIE

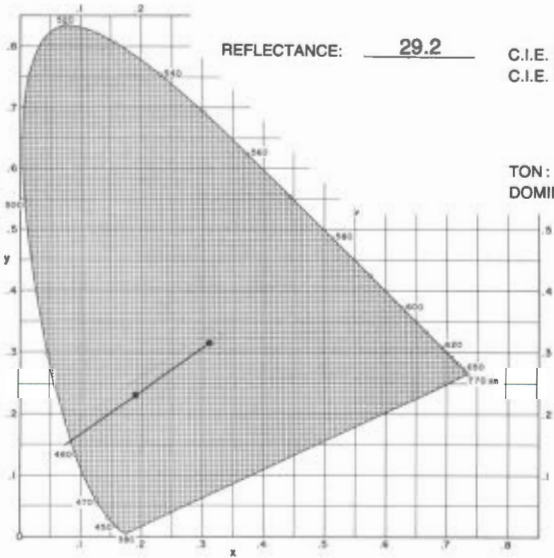

REFLECTANCE: 29.2 C.I.E. PURETÉ : 47%
C.I.E. PURITY

TON: 482
DOMINANT WAVELENGTH

Y: 29.2
X: 24.0
Z: 73.4

x: 0.190
y: 0.230

PAPER - PAPIER

PLATE - PLAQUE

GRADE / CATÉGORIE: W.S. STANDARD

SUBT. - SOUST. _____

TYPE: UNCOATED - NON COUCHÉ

TYPE: _____
NEGATIVE

REFLECTIVITÉ / REFLECTIVITY: 83%

PRESS - PRESSE

OPACITÉ / OPACITY: 87%

• MEHLE

% CONTRASTE/CONTRAST: 14%

• UNIT(É) #: LOWER/INFÉRIEURE

ID. PATCHES BLOCS IDEN.	% SCREEN TRAME	DENSITY DENSITE	% PRINT IMPRESSION
A	3	.10	6
B	6	.13	10
C	12	.17	18
D	22	.24	28
E	30	.32	40
F	40	.41	52
G	52	.52	66
H	66	.61	76
I	77	.69	81
J	87	.81	90
M	14	.21	23
N	27	.33	39
O	37	.41	49
P	51	.50	58
SOLID TEINTE PLATE	100	.97	100

The colour printed here was blended from, and should only be blended from PANTONE Basic Colours obtained from a PANTONE Licensed Printing Ink Manufacturer. Pantone, Inc. assumes no responsibility for the accuracy of the formulas or the colour reproduced.

La couleur ci-imprimée fut et devrait être mélangée seulement à partir des couleurs de base PANTONE obtenues d'un fabricant d'encre autorisé. La compagnie Pantone, Inc. n'assume aucune responsabilité quant à l'exactitude du mélange ou de la couleur obtenue.

RDD - DRD

COLOURS AND SCREENS

COULEURS ET TRAMES

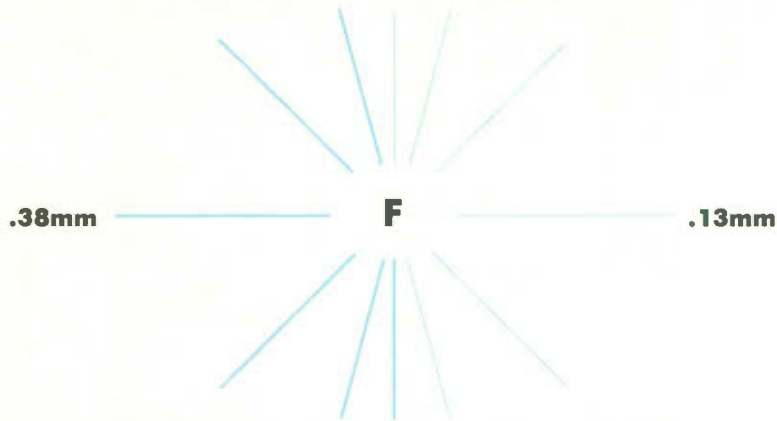

BIANGULAR SCREENS — TRAMES BIANGULÉES

M

6 pt. Triumvirate Roman/Romain	.08mm	
8 pt. Triumvirate Roman/Romain	.13mm	
10 pt. Futura Roman/Romain	.18mm	
12 pt. CG Trade Condensed/Condensé	.25mm	
	.38mm	

N

6 pt. Triumvirate Roman/Romain	.08mm	
8 pt. Futura Roman/Romain	.13mm	
10 pt. CG Trade Condensed/Condensé	.18mm	
12 pt. Cent. Text It/Italique	.25mm	
	.38mm	

O

6 pt. Futura Roman/Romain	.08mm	
8 pt. CG Trade Condensed/Condensé	.13mm	
10 pt. Century Text Italic/Italique	.18mm	
12 pt. Trium. Rom./Romain	.25mm	
	.38mm	

P

6 pt. CG Trade Condensed/Condensé	.08mm	
8 pt. Century Text Italic/Italique	.13mm	
10 pt. Triumvirate Roman/Romain	.18mm	
12 pt. Futura Roman/Romain	.25mm	
	.38mm	

SOLID — TEINTE PLATE

6 pt. Century Text Italic/Italique	.08mm	
8 pt. Triumvirate Roman/Romain	.13mm	
10 pt. Futura Roman/Romain	.18mm	
12 pt. CG Trade Condensed/Condensé	.25mm	
	.38mm	

A

B

C

D

E

F

G

H

I

J

S

TECHNICAL INFORMATION — DONNÉES TECHNIQUES

INK - ENCRE

PANTONE® * FORMUL (A)
(E)

COLOUR No. COULEUR : 4822-111

—1.000 parts Pantone Phtalo Cyanin

AIM SOLID DENSITY
DENSITÉ TEINTE PLATE VISÉE: 1.07 W/H 1.00 D/S

GRAYNESS - NETTETÉ : 13.5%

HUE ERROR - DÉVIATION DE : 28.3%
TEINTE

INK EFFICIENCY : 75.3%
EFFICACITÉ DE L'ENCRE

DENSITOMETRY / DENSITOMÉTRIE

- CHANNEL-SÉLECTION: CYAN
- FILTER TYPE DE FILTRES: STATUS T
- FACTEUR n FACTOR: 2.7

* Pantone, Inc.'s check-standard trademark for colour reproduction and colour reproduction materials.
* La marque de Pantone, Inc. de contrôle uniforme pour la reproduction en couleur et les matériaux pour la reproduction en couleur.

CIE CHROMATICITY DIAGRAM(ME) DES CHROMATICITÉS CIE

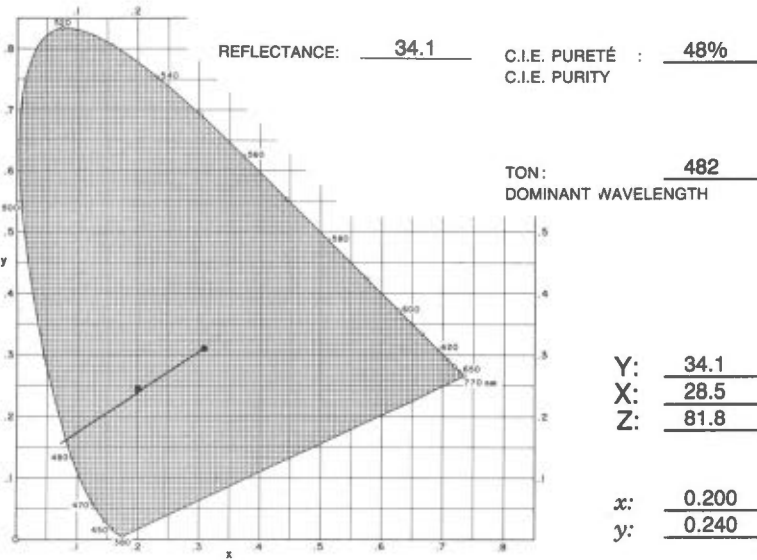

ID. PATCHES BLOCS IDEN.	% SCREEN TRAME	DENSITY DENSITÉ	% PRINT IMPRESSION
A	3	.11	4
B	6	.14	8
C	12	.20	15
D	22	.27	25
E	30	.35	34
F	40	.44	46
G	52	.57	58
H	66	.68	71
I	77	.81	82
J	87	.91	92
M	14	.24	20
N	27	.37	36
O	37	.44	44
P	51	.54	56
SOLID TEINTE PLATE	100	1.01	100

PAPER - PAPIER

GRADE / CATÉGORIE: W.S. NEW BRITE

TYPE: UNCOATED - NON COUCHÉ

REFLECTIVITÉ / REFLECTIVITY: 83.17%

OPACITÉ / OPACITY: 85.5%

% CONTRASTE/CONTRAST: 20%

PLATE - PLAQUE

SUBT. - SOUST. _____

TYPE: NEGATIVE

PRESS - PRESSE

• MEIHLE

• UNIT(É) #: LOWER/INFÉRIEURE

The colour printed here was blended from, and should only be blended from PANTONE Basic Colours obtained from a PANTONE Licensed Printing Ink Manufacturer.
Pantone, Inc. assumes no responsibility for the accuracy of the formulas or the colour reproduced.

La couleur ci-imprimée fut et devrait être mélangée seulement à partir des couleurs de base PANTONE obtenues d'un fabricant d'encre autorisé.
La compagnie Pantone, Inc. n'assume aucune responsabilité quant à l'exactitude du mélange ou de la couleur obtenue.

RDD - DRD
COLOURS AND SCREENS
COULEURS ET TRAMES

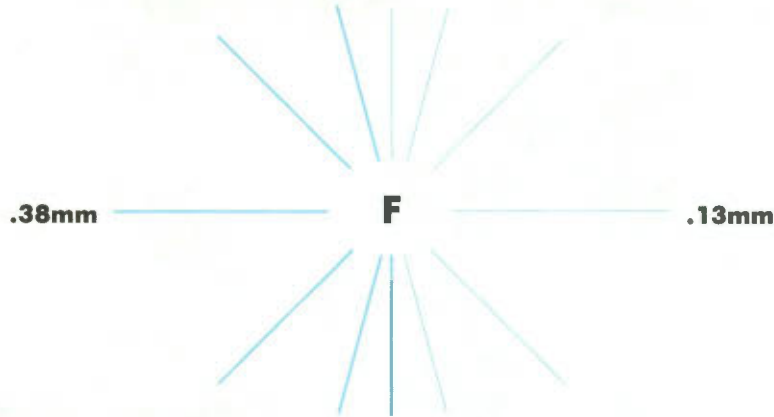

BIANGULAR SCREENS — TRAMES BIANGULÉES

M

6 pt. *Triumvirate Roman/Romain*
8 pt. *Triumvirate Roman/Romain*
10 pt. *Futura Roman/Romain*
12 pt. *CG Trade Condensed/Condensé*



N

6 pt. *Triumvirate Roman/Romain*
8 pt. *Futura Roman/Romain*
10 pt. *CG Trade Condensed/Condensé*
12 pt. *Cent. Text It./Italique*



O

6 pt. *Futura Roman/Romain*
8 pt. *CG Trade Condensed/Condensé*
10 pt. *Century Text Italic/Italique*
12 pt. *Trium. Rom./Romain*



P

6 pt. *CG Trade Condensed/Condensé*
8 pt. *Century Text Italic/Italique*
10 pt. *Triumvirate Roman/Romain*
12 pt. *Futura Roman/Romain*



SOLID — TEINTE PLATE

6 pt. *Century Text Italic/Italique*
8 pt. *Triumvirate Roman/Romain*
10 pt. *Futura Roman/Romain*
12 pt. *CG Trade Condensed/Condensé*



A

B

C

D

E

F

G

H

I

J

S

TECHNICAL INFORMATION — DONNÉES TECHNIQUES

INK - ENCRE

PANTONE® * FORMUL (A/E)

COLOUR No. COULEUR : 4822-111

— 1.000 parts Pantone Phtalo Cyanin

AIM SOLID DENSITY
DENSITÉ TEINTE PLATE VISÉE : 1.10 W/H 1.00 D/S

GRAYNESS - NETTETÉ : 11.3%

HUE ERROR - DÉVIATION DE : 26.5%
TEINTE

INK EFFICIENCY : 75.5%
EFFICACITÉ DE L'ENCRE

DENSITOMETRY / DENSITOMÉTRIE

• CHANNEL-SÉLECTION: CYAN

• FILTER TYPE DE FILTRES: STATUS T

• FACTEUR n FACTOR: 2.7

* Pantone, Inc.'s check-standard trademark for colour reproduction and colour reproduction materials.
* La marque de Pantone, Inc. de contrôle uniforme pour la reproduction en couleur et les matériaux pour la reproduction en couleur.

CIE CHROMATICITY DIAGRAM(ME) DES CHROMATICITÉS CIE

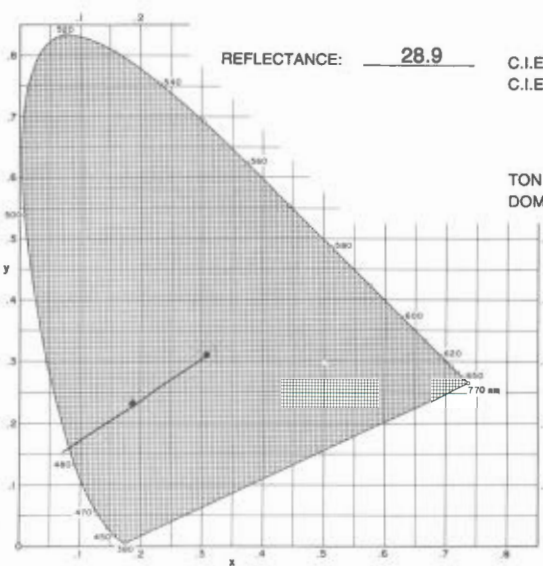

REFLECTANCE: 28.9 C.I.E. PURETÉ : 47%
C.I.E. PURITY

TON: 482
DOMINANT WAVELENGTH

Y: 28.9
X: 23.6
Z: 73.0

x: 0.190
y: 0.230

PAPER - PAPIER

GRADE / CATÉGORIE: CHART

TYPE: UNCOATED - NON COUCHÉ

REFLECTIVITÉ / REFLECTIVITY: 87%

OPACITÉ / OPACITY: 97.7%

% CONTRASTE/CONTRAST: 25%

PLATE - PLAQUE

SUBT. - SOUST. _____

TYPE: NEGATIVE

PRESS - PRESSE

• MEIHLE

• UNIT(É) #: LOWER/INFÉRIEURE

ID. PATCHES BLOCS IDEN.	% SCREEN TRAME	DENSITY DENSITÉ	% PRINT IMPRESSION
A	3	.08	4
B	6	.10	8
C	12	.15	14
D	22	.22	26
E	30	.29	34
F	40	.38	47
G	52	.49	58
H	66	.62	70
I	77	.73	79
J	87	.84	90
M	14	.18	19
N	27	.29	33
O	37	.38	44
P	51	.48	55
SOLID TEINTE PLATE	100	.97	100

The colour printed here was blended from, and should only be blended from PANTONE Basic Colours obtained from a PANTONE Licensed Printing Ink Manufacturer. Pantone, Inc. assumes no responsibility for the accuracy of the formulas or the colour reproduced.

La couleur ci-imprimée fut et devrait être mélangée seulement à partir des couleurs de base PANTONE obtenues d'un fabricant d'encre autorisé. La compagnie Pantone, Inc. n'assume aucune responsabilité quant à l'exactitude du mélange ou de la couleur obtenue.

TECHNICAL INFORMATION — DONNÉES TECHNIQUES

INK - ENCRE

PANTONE® * FORMUL (A)
(E)

COLOUR No. COULEUR : C-4970-125

—1.000 parts Pantone Rubine Red

AIM SOLID DENSITY
DENSITÉ TEINTE PLATE VISÉE: 1.07 W/H 0.98 D/S

GRAYNESS - NETTETÉ : 20.0%

HUE ERROR - DÉVIATION DE : 49.0%
TEINTE

INK EFFICIENCY : 60.0%
EFFICACITÉ DE L'ENCRE

DENSITOMETRY / DENSITOMÉTRIE

• CHANNEL-SÉLECTION: MAGENTA

• FILTER TYPE DE FILTRES: STATUS T

• FACTEUR n FACTOR: 2.7

* Pantone, Inc.'s check-standard trademark for colour reproduction and colour reproduction materials.
* La marque de Pantone, Inc. de contrôle uniforme pour la reproduction en couleur et les matériaux pour la reproduction en couleur.

CIE CHROMATICITY DIAGRAM(ME) DES CHROMATICITÉS CIE

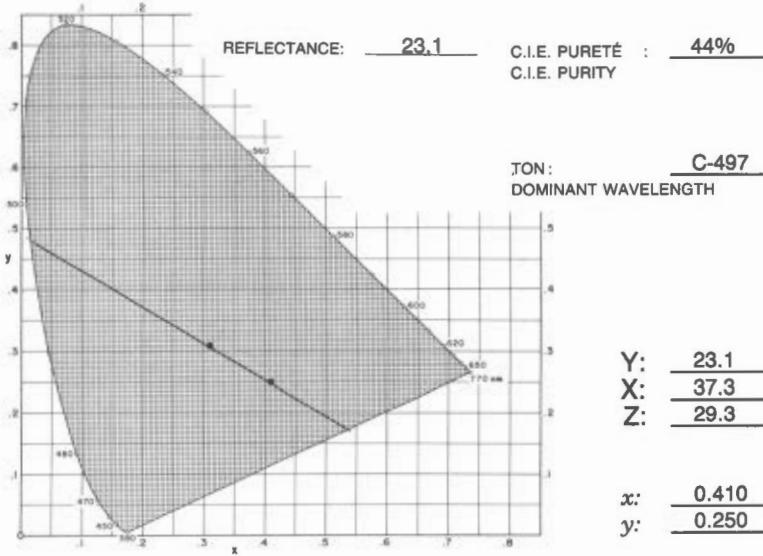

ID. PATCHES BLOCS IDEN.	% SCREEN TRAME	DENSITY DENSITÉ	% PRINT IMPRESSION
A	3	.13	9
B	6	.16	17
C	12	.23	25
D	22	.33	37
E	30	.44	50
F	40	.56	62
G	52	.67	77
H	66	.78	84
I	77	.88	92
J	87	.91	96
M	14	.30	33
N	27	.46	52
O	37	.53	60
P	51	.66	75
SOLID TEINTE PLATE	100	.96	100

PAPER - PAPIER

GRADE / CATÉGORIE: W.S. STANDARD

TYPE: UNCOATED - NON COUCHÉ

REFLECTIVITÉ / REFLECTIVITY: 85%

OPACITÉ / OPACITY: 87%

% CONTRASTE/CONTRAST: 8%

PLATE - PLAQUE

SUBT. - SOUST.

TYPE: NEGATIVE

PRESS - PRESSE

• MEIHLE

• UNIT(É) #: LOWER/INFÉRIEURE

The colour printed here was blended from, and should only be blended from PANTONE Basic Colours obtained from a PANTONE Licensed Printing Ink Manufacturer.
Pantone, Inc. assumes no responsibility for the accuracy of the formulas or the colour reproduced.

La couleur ci-imprimée fut et devrait être mélangée seulement à partir des couleurs de base PANTONE obtenues d'un fabricant d'encre autorisé.
La compagnie Pantone, Inc. n'assume aucune responsabilité quant à l'exactitude du mélange ou de la couleur obtenue.

TECHNICAL INFORMATION — DONNÉES TECHNIQUES

INK - ENCRE

PANTONE® * FORMUL (A/E)

COLOUR No. COULEUR : C-4970-125

— 1.000 parts Pantone Rubine Red

AIM SOLID DENSITY
DENSITÉ TEINTE PLATE VISÉE : 1.10 W/H 1.01 D/S

GRAYNESS - NETTETÉ : 21.0%

HUE ERROR - DÉVIATION DE : 51.0%
TEINTE

INK EFFICIENCY : 59.0%
EFFICACITÉ DE L'ENCRE

DENSITOMETRY / DENSITOMÉTRIE

- CHANNEL-SÉLECTION: MAGENTA
- FILTER TYPE DE FILTRES: STATUS T
- FACTEUR n FACTOR: 2.7

* Pantone, Inc.'s check-standard trademark for colour reproduction and colour reproduction materials.
* La marque de Pantone, Inc. de contrôle uniforme pour la reproduction en couleur et les matériaux pour la reproduction en couleur.

CIE CHROMATICITY DIAGRAM(ME) DES CHROMATICITÉS CIE

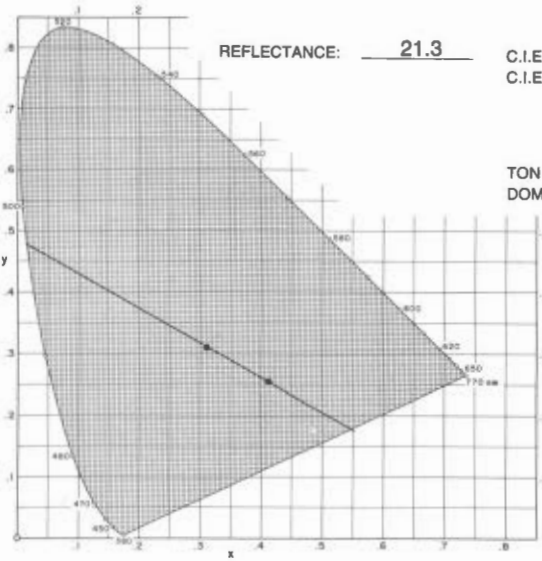

ID. PATCHES BLOCS IDEN.	% SCREEN TRAME	DENSITY DENSITÉ	% PRINT IMPRESSION
A	3	.12	7
B	6	.15	12
C	12	.21	20
D	22	.28	31
E	30	.37	44
F	40	.49	57
G	52	.67	75
H	66	.80	87
I	77	.87	94
J	87	.92	98
M	14	.26	28
N	27	.41	47
O	37	.49	58
P	51	.63	71
SOLID TEINTE PLATE	100	.95	100

PAPER - PAPIER

PLATE - PLAQUE

GRADE / CATÉGORIE: W.S. NEW BRITE

SUBT. - SOUST.

TYPE: UNCOATED - NON COUCHÉ

TYPE: NEGATIVE

REFLECTIVITÉ / REFLECTIVITY: 85%

PRESS - PRESSE

OPACITÉ / OPACITY: 85.5%

• MEIHLE

% CONTRASTE/CONTRAST: 8%

• UNIT(É) #: LOWER/INFÉRIEURE

The colour printed here was blended from, and should only be blended from PANTONE Basic Colours obtained from a PANTONE Licensed Printing Ink Manufacturer.
Pantone, Inc. assumes no responsibility for the accuracy of the formulas or the colour reproduced.

La couleur ci-imprimée fut et devrait être mélangée seulement à partir des couleurs de base PANTONE obtenues d'un fabricant d'encre autorisé.
La compagnie Pantone, Inc. n'assume aucune responsabilité quant à l'exactitude du mélange ou de la couleur obtenue.

RDD - DRD

COLOURS AND SCREENS

COULEURS ET TRAMES

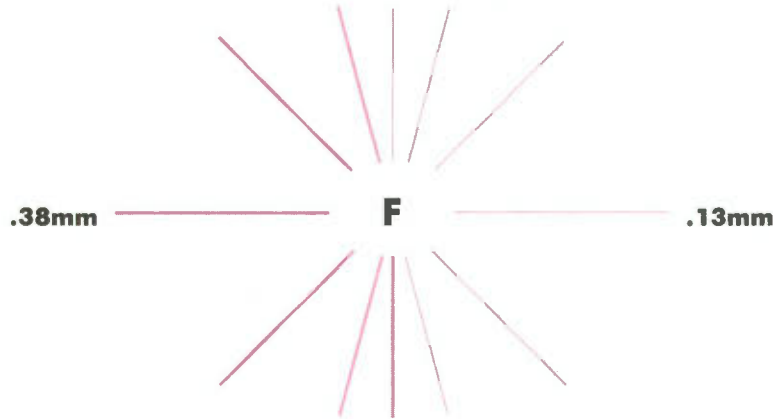

BIANGULAR SCREENS — TRAMES BIANGULÉES

M

6 pt. Century Text Italic/Italique
8 pt. Triumvirate Roman/Romain
10 pt. Futura Roman/Romain
12 pt. CG Trade Condensed/Condensé



N

6 pt. Triumvirate Roman/Romain
8 pt. Futura Roman/Romain
10 pt. CG Trade Condensed/Condensé
12 pt. Cent. Text It./Italique



O

6 pt. Futura Roman/Romain
8 pt. CG Trade Condensed/Condensé
10 pt. Century Text Italic/Italique
12 pt. Trium. Rom./Romain



P

6 pt. CG Trade Condensed/Condensé
8 pt. Century Text Italic/Italique
10 pt. Triumvirate Roman/Romain
12 pt. Futura Roman/Romain



SOLID — TEINTE PLATE

6 pt. Century Text Italic/Italique
8 pt. Triumvirate Roman/Romain
10 pt. Futura Roman/Romain
12 pt. CG Trade Condensed/Condensé



A

B

C

D

E

F

G

H

I

J

S

TECHNICAL INFORMATION — DONNÉES TECHNIQUES

INK - ENCRE

PANTONE® * FORMUL (A)
(E)

COLOUR No. COULEUR : C-4970-125

— 1.000 parts Pantone Rubine Red

AIM SOLID DENSITY
DENSITÉ TEINTE PLATE VISÉE : 1.11 W/H 1.04 D/S

GRAYNESS - NETTETÉ : 19.0%

HUE ERROR - DÉVIATION DE : 53.0%
TEINTE

INK EFFICIENCY : 60.0%
EFFICACITÉ DE L'ENCRE

DENSITOMETRY / DENSITOMÉTRIE

• CHANNEL-SÉLECTION: MAGENTA

• FILTER TYPE DE FILTRES: STATUS T

• FACTEUR n FACTOR: 2.7

* Pantone, Inc.'s check-standard trademark for colour reproduction and colour reproduction materials.
* La marque de Pantone, Inc. de contrôle uniforme pour la reproduction en couleur et les matériaux pour la reproduction en couleur.

CIE CHROMATICITY DIAGRAM(ME) DES CHROMATICITÉS CIE

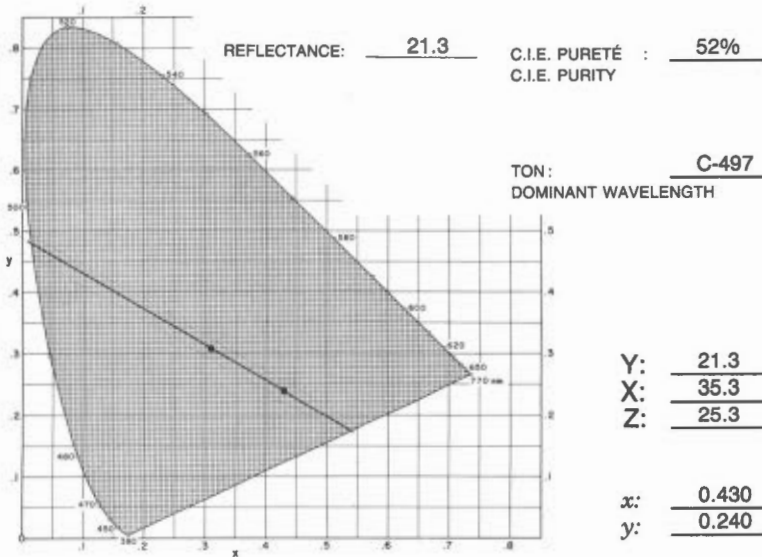

ID. PATCHES BLOCS IDEN.	% SCREEN FRAME	DENSITY DENSITÉ	% PRINT IMPRESSION
A	3	.11	8
B	6	.15	14
C	12	.21	24
D	22	.30	36
E	30	.39	48
F	40	.51	61
G	52	.71	78
H	66	.80	89
I	77	.90	98
J	87	.95	99
M	14	.28	30
N	27	.43	48
O	37	.52	58
P	51	.70	75
SOLID TEINTE PLATE	100	.96	100

PAPER - PAPIER

GRADE / CATÉGORIE: CHART

TYPE: UNCOATED - NON COUCHÉ

REFLECTIVITÉ / REFLECTIVITY: 87%

OPACITÉ / OPACITY: 96.5%

% CONTRASTE/CONTRAST: 6%

PLATE - PLAQUE

SUBT. - SOUST.

TYPE: NEGATIVE

PRESS - PRESSE

• MEHLE

• UNIT(É) #: LOWER/INFÉRIEURE

The colour printed here was blended from, and should only be blended from PANTONE Basic Colours obtained from a PANTONE Licensed Printing Ink Manufacturer.
Pantone, Inc. assumes no responsibility for the accuracy of the formulas or the colour reproduced.

La couleur ci-imprimée fut et devrait être mélangée seulement à partir des couleurs de base PANTONE obtenues d'un manufacturier d'encre autorisé.
La compagnie Pantone, Inc. n'assume aucune responsabilité quant à l'exactitude du mélange ou de la couleur obtenue.

RDD - DRD

COLOURS AND SCREENS

COULEURS ET TRAMES

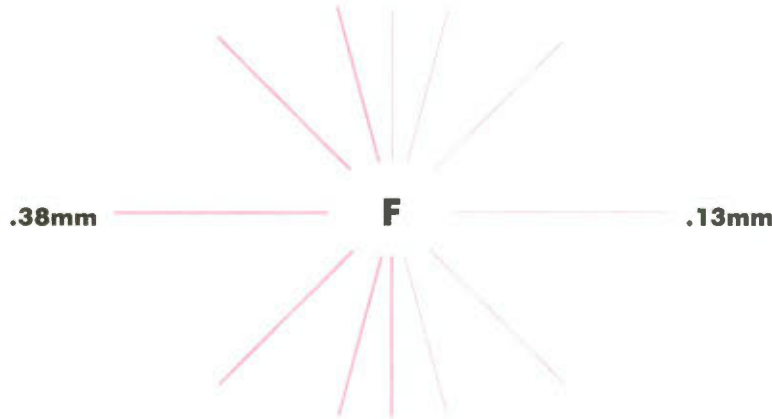

BIANGULAR SCREENS — TRAMES BIANGULÉES

M

6 pt. *Century Text Italic/Italique*
8 pt. *Triumvirate Roman/Romain*
10 pt. *Futura Roman/Romain*
12 pt. *CG Trade Condensed/Condensé*

.08mm
.13mm
.18mm
.25mm
.38mm

N

6 pt. *Triumvirate Roman/Romain*
8 pt. *Futura Roman/Romain*
10 pt. *CG Trade Condensed/Condensé*
12 pt. *Cent. Text It./Italique*

.08mm
.13mm
.18mm
.25mm
.38mm

O

6 pt. *Futura Roman/Romain*
8 pt. *CG Trade Condensed/Condensé*
10 pt. *Century Text Italic/Italique*
12 pt. *Trium. Rom./Romain*

.08mm
.13mm
.18mm
.25mm
.38mm

P

6 pt. *CG Trade Condensed/Condensé*
8 pt. *Century Text Italic/Italique*
10 pt. *Triumvirate Roman/Romain*
12 pt. *Futura Roman/Romain*

.08mm
.13mm
.18mm
.25mm
.38mm

SOLID — TEINTE PLATE

6 pt. *Century Text Italic/Italique*
8 pt. *Triumvirate Roman/Romain*
10 pt. *Futura Roman/Romain*
12 pt. *CG Trade Condensed/Condensé*

.08mm
.13mm
.18mm
.25mm
.38mm

A

B

C

D

E

F

G

H

I

J

S

TECHNICAL INFORMATION — DONNÉES TECHNIQUES

INK - ENCRE

PANTONE® * FORMUL (A/E)

COLOUR No. COULEUR : 5732-165

— 1.000 parts Pantone Benzidine Yellow

AIM SOLID DENSITY
DENSITÉ TEINTE PLATE VISÉE : 0.90 W/H 0.82 D/S

GRAYNESS - NETTETÉ : 1.2%

HUE ERROR - DÉVIATION DE : 5.7%
TEINTE

INK EFFICIENCY : 95.7%
EFFICACITÉ DE L'ENCRE

DENSITOMETRY / DENSITOMÉTRIE

• CHANNEL-SÉLECTION: YELLOW

• FILTER TYPE DE FILTRES: STATUS T

• FACTEUR n FACTOR: 2.7

* Pantone, Inc.'s check-standard trademark for colour reproduction and colour reproduction materials.
* La marque de Pantone, Inc. de contrôle uniforme pour la reproduction en couleur et les matériaux pour la reproduction en couleur.

CIE CHROMATICITY DIAGRAM(ME) DES CHROMATICITÉS CIE

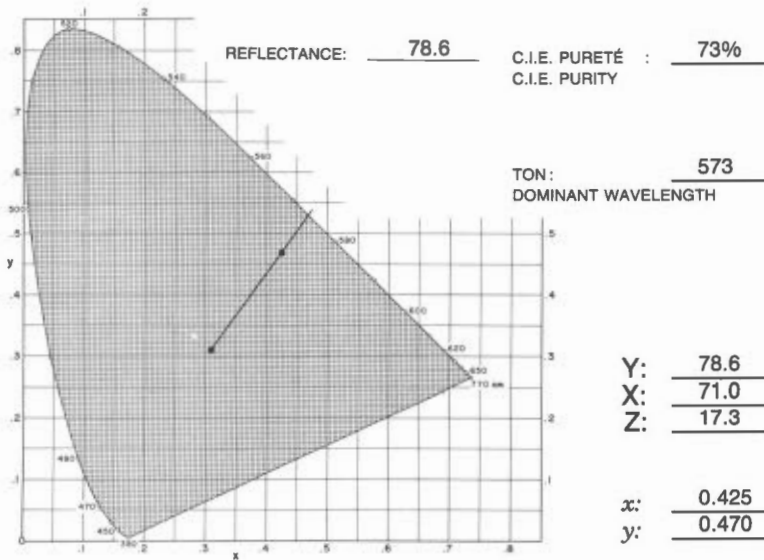

ID. PATCHES BLOCS IDEN.	% SCREEN TRAME	DENSITY DENSITÉ	% PRINT IMPRESSION
A	3	.13	4
B	6	.15	7
C	12	.20	17
D	22	.27	27
E	30	.34	38
F	40	.42	50
G	52	.53	63
H	66	.63	77
I	77	.72	87
J	87	.76	95
M	14	.24	20
N	27	.35	32
O	37	.42	38
P	51	.50	48
SOLID TEINTE PLATE	100	.81	100

PAPER - PAPIER

GRADE / CATÉGORIE: W.S. STANDARD

TYPE: UNCOATED - NON COUCHÉ

REFLECTIVITÉ / REFLECTIVITY: 83%

OPACITÉ / OPACITY: 85.5%

% CONTRASTE/CONTRAST: 12%

PLATE - PLAQUE

TYPE: SUBT. - SOUST.

TYPE: NEGATIVE

PRESS - PRESSE

• MEIHLE

• UNIT(É) #: LOWER/INFÉRIEURE

The colour printed here was blended from, and should only be blended from PANTONE Basic Colours obtained from a PANTONE Licensed Printing Ink Manufacturer.
Pantone, Inc. assumes no responsibility for the accuracy of the formulas or the colour reproduced.

La couleur ci-imprimée fut et devrait être mélangée seulement à partir des couleurs de base PANTONE obtenues d'un fabricant d'encre autorisé.
La compagnie Pantone, Inc. n'assume aucune responsabilité quant à l'exactitude du mélange ou de la couleur obtenue.

RDD - DRD

COLOURS AND SCREENS

COULEURS ET TRAMES

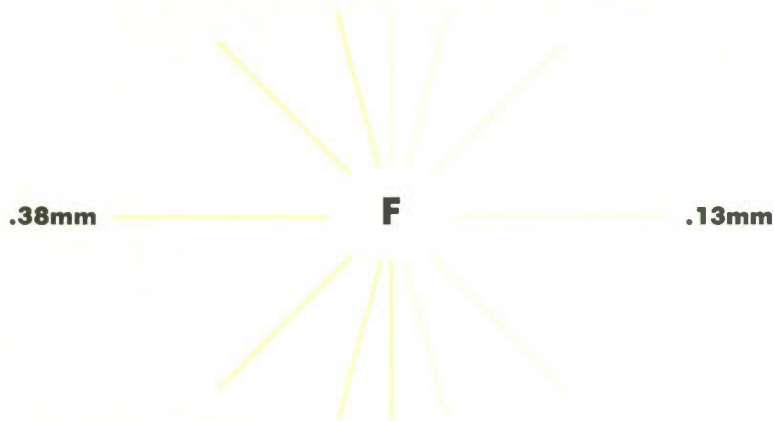

BIANGULAR SCREENS — TRAMES BIANGULÉES

M

4 pt. Triumphal Roman/Romain	.08mm	
6 pt. Triumphal Roman/Romain	.15mm	
10 pt. Futura Roman/Romain	.18mm	
12 pt. CG Trade Condensed/Condensé	.25mm	
	.38mm	

N

4 pt. Triumphal Roman/Romain	.08mm	
6 pt. Futura Roman/Romain	.15mm	
10 pt. CG Trade Condensed/Condensé	.18mm	
12 pt. Cent. Text It./Italique	.25mm	
	.38mm	

O

4 pt. Century Roman/Romain	.08mm	
6 pt. CG Trade Condensed/Condensé	.15mm	
10 pt. Century Text It./Italique	.18mm	
12 pt. Trium. Rom./Romain	.25mm	
	.38mm	

P

4 pt. CG Trade Condensed/Condensé	.08mm	
6 pt. Century Text It./Italique	.15mm	
10 pt. Triumvirate Roman/Romain	.18mm	
12 pt. Futura Roman/Romain	.25mm	
	.38mm	

SOLID — TEINTE PLATE

4 pt. Century Text It./Italique	.08mm	
6 pt. Triumvirate Roman/Romain	.15mm	
10 pt. Futura Roman/Romain	.18mm	
12 pt. CG Trade Condensed/Condensé	.25mm	
	.38mm	

A

B

C

D

E

F

G

H

I

J

S

TECHNICAL INFORMATION — DONNÉES TECHNIQUES

INK - ENCRE

PANTONE® * FORMUL (A)
(E)

COLOUR No. COULEUR : 5732-165

— 1.000 parts Pantone Benzidine Yellow

AIM SOLID DENSITY
DENSITÉ TEINTE PLATE VISÉE: 0.95 W/H 0.93 D/S

GRAYNESS - NETTETÉ : 2.1%

HUE ERROR - DÉVIATION DE : 6.0%
TEINTE

INK EFFICIENCY : 95.3%
EFFICACITÉ DE L'ENCRE

DENSITOMETRY / DENSITOMÉTRIE

• CHANNEL-SÉLECTION: YELLOW

• FILTER TYPE DE FILTRES: STATUS T

• FACTEUR n FACTOR: 2.7

* Pantone, Inc.'s check-standard trademark for colour reproduction and colour reproduction materials.
* La marque de Pantone, Inc. de contrôle uniforme pour la reproduction en couleur et les matériaux pour la reproduction en couleur.

CIE CHROMATICITY DIAGRAM(ME) DES CHROMATICITÉS CIE

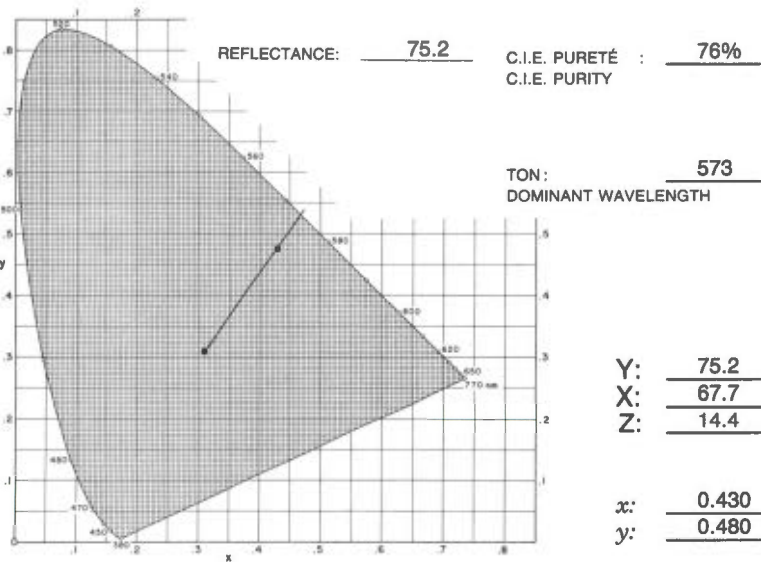

ID. PATCHES BLOCS IDEN.	% SCREEN TRAME	DENSITY DENSITÉ	% PRINT IMPRESSION
A	3	.10	5
B	6	.13	8
C	12	.17	17
D	22	.25	27
E	30	.31	39
F	40	.40	50
G	52	.50	62
H	66	.62	78
I	77	.71	85
J	87	.80	92
M	14	.20	21
N	27	.31	35
O	37	.39	47
P	51	.46	58
SOLID TEINTE PLATE	100	.86	100

PAPER - PAPIER

GRADE / CATÉGORIE: W.S. NEW BRITE

TYPE: UNCOATED - NON COUCHÉ

REFLECTIVITÉ / REFLECTIVITY: 83.17%

OPACITÉ / OPACITY: 85.5%

% CONTRASTE/CONTRAST: 16%

PLATE - PLAQUE

SUBT. - SOUST.

TYPE: NEGATIVE

PRESS - PRESSE

• MEIHLE

• UNIT(É) #: LOWER/INFÉRIEURE

The colour printed here was blended from, and should only be blended from PANTONE Basic Colours obtained from a PANTONE Licensed Printing Ink Manufacturer.
Pantone, Inc. assumes no responsibility for the accuracy of the formulas or the colour reproduced.

La couleur ci-imprimée fut et devrait être mélangée seulement à partir des couleurs de base PANTONE obtenues d'un fabricant d'encre autorisé.
La compagnie Pantone, Inc. n'assume aucune responsabilité quant à l'exactitude du mélange ou de la couleur obtenue.

0 1 2 3
8 3 5 8
m m m m

COLOUR NO. 165
No. DE COULEUR 165

RDD - DRD

COLOURS AND SCREENS

COULEURS ET TRAMES

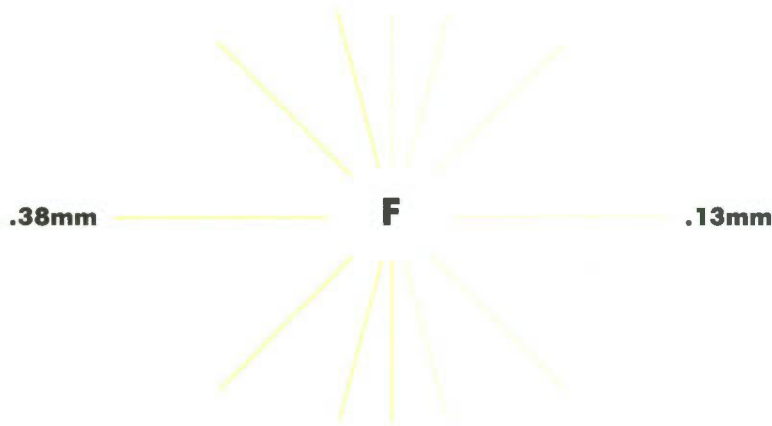

BIANGULAR SCREENS — TRAMES BIANGULÉES

M

6 pt. <i>Century Roman/Romain</i>	.08mm	
8 pt. <i>Century Roman/Romain</i>	.13mm	
10 pt. <i>Futura Roman/Romain</i>	.18mm	
12 pt. <i>CG Trade Condensed/Condensé</i>	.25mm	
	.38mm	

N

6 pt. <i>Century Roman/Romain</i>	.08mm	
8 pt. <i>Futura Roman/Romain</i>	.13mm	
10 pt. <i>CG Trade Condensed/Condensé</i>	.18mm	
12 pt. <i>Cent. Text It./Italique</i>	.25mm	
	.38mm	

O

6 pt. <i>Futura Roman/Romain</i>	.08mm	
8 pt. <i>CG Trade Condensed/Condensé</i>	.13mm	
10 pt. <i>Century Text Italic/Italique</i>	.18mm	
12 pt. <i>Trium. Rom./Romain</i>	.25mm	
	.38mm	

P

6 pt. <i>CG Trade Condensed/Condensé</i>	.08mm	
8 pt. <i>Century Text Italic/Italique</i>	.13mm	
10 pt. <i>Triumvirate Roman/Romain</i>	.18mm	
12 pt. <i>Futura Roman/Romain</i>	.25mm	
	.38mm	

SOLID — TEINTE PLATE

6 pt. <i>Century Text Italic/Italique</i>	.08mm	
8 pt. <i>Triumvirate Roman/Romain</i>	.13mm	
10 pt. <i>Futura Roman/Romain</i>	.18mm	
12 pt. <i>CG Trade Condensed/Condensé</i>	.25mm	
	.38mm	

A

B

C

D

E

F

G

H

I

J

S

0 0 0 0
3 5 7 5

TECHNICAL INFORMATION — DONNÉES TECHNIQUES

INK - ENCRE

PANTONE® * FORMUL (A/E)

COLOUR No. COULEUR : 5732-165

— 1.000 parts Pantone Benzidine Yellow

AIM SOLID DENSITY : 0.92 W/H 0.86 D/S
 DENSITÉ TEINTE PLATE VISÉE :

GRAYNESS - NETTETÉ : 2.4%

DENSITOMETRY / DENSITOMÉTRIE

HUE ERROR - DÉVIATION DE : 5.5%
 TEINTE

• CHANNEL-SÉLECTION: YELLOW

INK EFFICIENCY : 96.0%
 EFFICACITÉ DE L'ENCRE

• FILTER TYPE DE FILTRES: STATUS T

• FACTEUR n FACTOR: 2.7

* Pantone, Inc.'s check-standard trademark for colour reproduction and colour reproduction materials.

* La marque de Pantone, Inc. de contrôle uniforme pour la reproduction en couleur et les matériaux pour la reproduction en couleur.

CIE CHROMATICITY DIAGRAM(ME) DES CHROMATICITÉS CIE

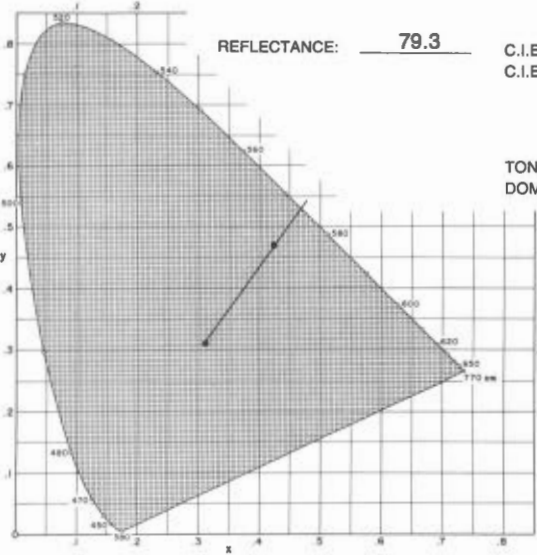

REFLECTANCE: 79.3 C.I.E. PURETÉ : 73%
 C.I.E. PURITY

TON: 573
 DOMINANT WAVELENGTH

Y: 79.3
 X: 71.6
 Z: 17.3

x: 0.425
 y: 0.470

PAPER - PAPIER

PLATE - PLAQUE

GRADE / CATÉGORIE: CHART

SUBT. - SOUST.

TYPE: UNCOATED - NON COUCHÉ

TYPE: NEGATIVE

REFLECTIVITÉ / REFLECTIVITY: 79%

PRESS - PRESSE

OPACITÉ / OPACITY: 96.2%

• MEIHLÉ

% CONTRASTE/CONTRAST: 19%

• UNIT(É) #: LOWER/INFÉRIEURE

ID. PATCHES BLOCS IDEN.	% SCREEN TRAME	DENSITY DENSITÉ	% PRINT IMPRESSION
A	3	.12	4
B	6	.14	7
C	12	.18	14
D	22	.25	24
E	30	.29	34
F	40	.38	45
G	52	.46	56
H	66	.57	71
I	77	.68	83
J	87	.75	92
M	14	.21	20
N	27	.29	36
O	37	.37	45
P	51	.46	56
SOLID TEINTE PLATE	100	.80	100

The colour printed here was blended from, and should only be blended from PANTONE Basic Colours obtained from a PANTONE Licensed Printing Ink Manufacturer. Pantone, Inc. assumes no responsibility for the accuracy of the formulas or the colour reproduced.

La couleur ci-imprimée fut et devrait être mélangée seulement à partir des couleurs de base PANTONE obtenues d'un fabricant d'encre autorisé. La compagnie Pantone, Inc. n'assume aucune responsabilité quant à l'exactitude du mélange ou de la couleur obtenue.

RDD - DRD

COLOURS AND SCREENS

COULEURS ET TRAMES

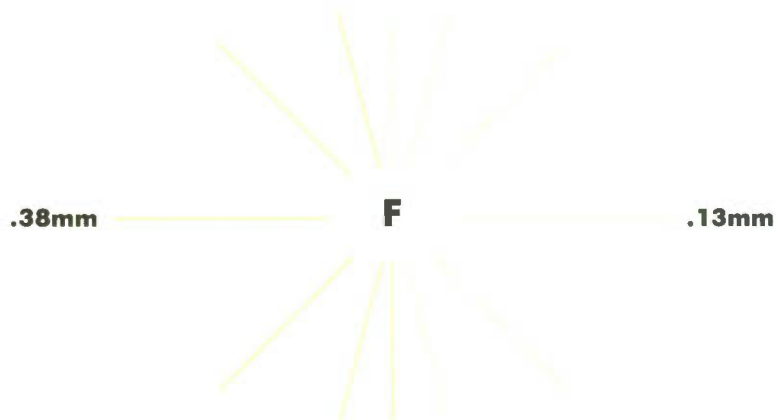

BIANGULAR SCREENS — TRAMES BIANGULÉES

M

12 pt. Century Text Italic/Italique	.08mm	
10 pt. Futura Roman/Romain	.13mm	
10 pt. CG Trade Condensed/Condensé	.18mm	
12 pt. Century Text Italic/Italique	.25mm	
12 pt. Futura Roman/Romain	.38mm	

N

12 pt. Century Text Italic/Italique	.08mm	
10 pt. Futura Roman/Romain	.13mm	
10 pt. CG Trade Condensed/Condensé	.18mm	
12 pt. Century Text Italic/Italique	.25mm	
12 pt. Futura Roman/Romain	.38mm	

O

12 pt. Century Text Italic/Italique	.08mm	
10 pt. Futura Roman/Romain	.13mm	
10 pt. CG Trade Condensed/Condensé	.18mm	
12 pt. Century Text Italic/Italique	.25mm	
12 pt. Trium. Rom./Romain	.38mm	

P

12 pt. Century Text Italic/Italique	.08mm	
8 pt. Century Text Italic/Italique	.13mm	
10 pt. Triumvirate Roman/Romain	.18mm	
10 pt. Futura Roman/Romain	.25mm	
12 pt. Futura Roman/Romain	.38mm	

SOLID — TEINTE PLATE

12 pt. Century Text Italic/Italique	.08mm	
8 pt. Triumvirate Roman/Romain	.13mm	
10 pt. Futura Roman/Romain	.18mm	
12 pt. CG Trade Condensed/Condensé	.25mm	
12 pt. Futura Roman/Romain	.38mm	

A

B

C

D

E

F

G

H

I

J

S

TECHNICAL INFORMATION — DONNÉES TECHNIQUES

INK - ENCRE

PANTONE® * FORMUL (A/E)

COLOUR No. COULEUR : _____

AIM SOLID DENSITY
DENSITÉ TEINTE PLATE VISÉE : _____

GRAYNESS - NETTETÉ : _____

HUE ERROR - DÉVIATION DE : _____
TEINTE

INK EFFICIENCY : _____
EFFICACITÉ DE L'ENCRE

DENSITOMETRY / DENSITOMÉTRIE

- CHANNEL-SÉLECTION: _____
- FILTER TYPE DE FILTRES: _____
- FACTEUR n FACTOR: _____

* Pantone, Inc.'s check-standard trademark for colour reproduction and colour reproduction materials.

* La marque de Pantone, Inc. de contrôle uniforme pour la reproduction en couleur et les matériaux pour la reproduction en couleur.

CIE CHROMATICITY DIAGRAM(ME) DES CHROMATICITÉS CIE

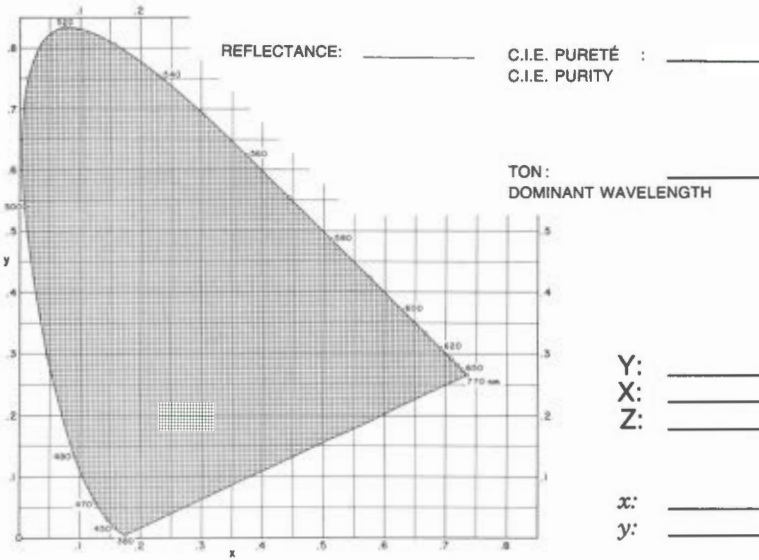

PAPER - PAPIER

PLATE - PLAQUE

GRADE / CATÉGORIE: _____

TYPE: _____

TYPE: _____

REFLECTIVITÉ / REFLECTIVITY: _____

PRESS - PRESSE

OPACITÉ / OPACITY: _____

% CONTRASTE/CONTRAST: _____

• UNIT(É) #: _____

ID. PATCHES BLOCS IDEN.	% SCREEN TRAME	DENSITY DENSITÉ	% PRINT IMPRESSION
A			
B			
C			
D			
E			
F			
G			
H			
I			
J			
M			
N			
O			
P			
SOLID TEINTE PLATE			

The colour printed here was blended from, and should only be blended from PANTONE Basic Colours obtained from a PANTONE Licensed Printing Ink Manufacturer.
Pantone, Inc. assumes no responsibility for the accuracy of the formulas or the colour reproduced.

La couleur ci- imprimée fut et devrait être mélangée seulement à partir des couleurs de base PANTONE obtenues d'un fabricant d'encre autorisé.
La compagnie Pantone, Inc. n'assume aucune responsabilité quant à l'exactitude du mélange ou de la couleur obtenue.

TECHNICAL INFORMATION

DONNÉES TECHNIQUES

INTRODUCTION

The information contained in this sheet specified the data collected at the time of printing of the colour plates. It represents the ideal aim point for the combination of substrate, ink and printing conditions. This information does not imply a printing standard which must account for allowable deviations from the ideal. Development of a standard is product dependent and is achieved by a quality assurance program.

INTRODUCTION

Les renseignements fournis dans le présent document reflètent les données recueillies au moment de l'impression des plaques colorimétriques. Ils représentent l'objectif idéal fixé pour la combinaison support, encre et conditions d'impression. Les présentes données ne s'appliquent pas à un étalon d'impression qui doit tenir compte des écarts admis par rapport à l'idéal. L'établissement d'un étalon est fonction d'un produit et relève d'un programme d'assurance de la qualité.

DEFINITION AND SAMPLE CALCULATIONS

- Pantone Formula

A 100 part formulae showing the proportional blend of one or more of the basic eight Pantone inks plus black and white bases used to formulate ink.

Example: Brown Contour 130

Pantone Formula:

.565 parts Pantone Yellow
.239 parts Pantone Warm Red
.087 parts Pantone Rubine Red
.109 parts Pantone Black

- Hue Error *

A term used to describe unwanted absorption and reflection of a process colour ink. An ideal process ink will absorb one third of the spectrum and reflect two thirds. Hue Error is defined by the following equation:

Hue Error % =

$$\frac{\text{Medium density} - \text{Low density}}{\text{High density} - \text{Low density}} \times 100\%$$

Example:

Red filter density reading 0.09
Green filter density reading 0.89
Blue filter density reading 0.33

Hue Error % =

$$\frac{0.33 - 0.09}{0.89 - 0.09} \times 100\% = 30\%$$

DÉFINITIONS ET EXEMPLES DE CALCULS

- Formule Pantone

Formule à 100 parties indiquant le mélange proportionnel de l'une des huit encres de base Pantone ainsi que des couleurs de fond, soit le noir et le blanc, utilisées pour composer l'encre.

Exemple: Brun contour 130

Formule Pantone:

.565 parties du jaune Pantone
.239 parties du rouge chaud Pantone
.087 parties du rouge rubine Pantone
.109 parties du noir Pantone

- Erreur de tonalité (chromatique) *
ou deviation de teinte

Terme utilisé pour décrire l'absorption et la réflexion non désirées d'une encre pour quadrichromie. Une encre pour quadrichromie idéale absorbera un tiers du spectre et en réfléchira les deux tiers. L'erreur de tonalité est définie par l'équation suivante:

Erreur de tonalité % =

$$\frac{\text{Densité moyenne} - \text{densité basse}}{\text{Densité élevée} - \text{densité basse}} \times 100\%$$

Exemple:

Lecture densité avec filtre rouge 0.09
Lecture densité avec filtre vert 0.89
Lecture densité avec filtre bleu 0.33

Erreur de tonalité % =

$$\frac{0.33 - 0.09}{0.89 - 0.09} \times 100\% = 30\%$$

- Grayness *

A term used to express the purity of a process colour ink as its freedom from Gray. The Grayness is defined by the following equation:

Grayness % =

$$\frac{\text{Low density}}{\text{High density}} \times 100\%$$

Example using the above density readings:

Grayness % =

$$\frac{0.09}{0.89} \times 100\% = 10\%$$

- Ink Efficiency *

A measure of how well a process colour absorbs one-third of the spectrum and reflects two-thirds of it. The equation is:

Efficiency % =

$$1 - \frac{\text{Low density} + \text{Medium density}}{2 \times \text{High density}} \times 100\%$$

Example using the above density readings:

Efficiency % =

$$1 - \frac{0.09 + 0.33}{2 \times 0.89} \times 100\% = 76\%$$

* The terms apply to process colour inks and their overprints exclusively.

- Tendance au gris * (netteté)

Terme utilisé pour qualifier la pureté d'une encre pour quadrichromie en ce qui a trait à son aspect exempt de gris. La tendance au gris est définie par l'équation suivante:

Tendance au gris % =

$$\frac{\text{Densité basse}}{\text{Densité élevée}} \times 100\%$$

Exemple à l'aide des valeurs de densité susmentionnées:

Tendance au gris % =

$$\frac{0.09}{0.89} \times 100\% = 10\%$$

- Efficacité de l'encre *

Évaluation de la mesure dans laquelle une couleur primaire absorbe un tiers du spectre et en réfléchit les deux tiers. L'équation est la suivante:

Efficacité % =

$$1 - \frac{\text{Densité basse} + \text{densité moyenne}}{2 \times \text{densité élevée}} \times 100\%$$

Exemple à l'aide des valeurs de densité susmentionnées:

Efficacité % =

$$1 - \frac{0.09 + 0.33}{2 \times 0.89} \times 100\% = 76\%$$

* Ces termes s'appliquent exclusivement aux encres pour la quadrichromie et à leurs surimpressions.

- CIE Purity

The distance from the illuminant point to the sample point divided by the distance from the illuminant point to the spectrum locus as measured on the 1931 CIE chromaticity diagram.

Example:

Process Cyan 111

d_1 . . . distance from illuminant C to the sample point = 26 mm

d_2 . . . distance from illuminant C to the spectrum locus = 56 mm

Purity % =

$$\frac{d_1}{d_2} \times 100\% = \frac{26\text{mm}}{56\text{mm}} \times 100\% = 47\%$$

- Dominant Wavelength

The straight line drawn from white located at the center of the chromaticity chart to the position of the measured sample to intercept the spectral locus. The wavelength value shown on the diagram will indicate the hue and indeed the dominant wavelength of the measured sample.

- Reflectance

Reflectance is defined as the tristimulus value Y which corresponds to the lightness or the luminance of the sample.

- Pureté CIE

Distance séparant le point illuminant et le point échantillon divisée par la distance séparant le point illuminant et le lieu spectral comme l'indique le diagramme de chromaticité CIE 1931.

Exemple:

Couleur primaire cyan 111

d_1 . . . distance entre l'illuminant C et le point échantillon = 26 mm

d_2 . . . distance entre l'illuminant C et le lieu spectral = 56 mm

Pureté % =

$$\frac{d_1}{d_2} \times 100\% = \frac{26\text{mm}}{56\text{mm}} \times 100\% = 47\%$$

- Longueur d'onde dominante

La ligne droite tracée à partir du blanc situé au centre du diagramme de chromaticité jusqu'au point de l'échantillon mesuré afin d'intercepter le lieu spectral. La valeur de la longueur d'onde apparaissant sur le diagramme indiquera la teinte et même la longueur d'onde de l'échantillon mesuré.

- Réflectance

Composante trichromatique Y correspondant à la clarté ou à la luminance de l'échantillon.

- Y X Z Tristimulus Values

Those values are defined by the following equation:

$$X = \int_{380\text{nm}}^{770\text{nm}} S_{\lambda} \cdot R_{\lambda} \cdot \bar{x} \cdot d_{\lambda}$$

WHERE: S_{λ} ... Spectral energy distribution of the illuminant.

R_{λ} ... The reflectance of a colour at a given wavelength.

The tristimulus values (either \bar{X} \bar{Y} \bar{Z}) of the CIE standard observer.

Y and Z are similarly defined.

- Composantes trichromatiques Y X Z

Valeurs définies par l'équation suivante:

$$X = \int_{380\text{nm}}^{770\text{nm}} S_{\lambda} \cdot R_{\lambda} \cdot \bar{x} \cdot d_{\lambda}$$

OÙ: S_{λ} ... Répartition spectrale d'énergie de l'illuminant

R_{λ} ... Facteur de réflexion d'une couleur à une longueur d'onde donnée.

Composantes trichromatiques (soit \bar{X} \bar{Y} \bar{Z}) de l'observateur de référence CIE.

Y et Z sont définies de façon semblable.

- x y Chromaticity Coordinates

Those values are used to define the chromaticity which correlate to some extent with hue and chroma. The coordinates are obtained from the following equations:

$$x = \frac{X}{X + Y + Z} \quad y = \frac{Y}{X + Y + Z}$$

Two co-ordinates are sufficient (along with Y) to define a colour since $x + y + z = 1$.

- Coordonnées trichromatiques x y

Valeurs utilisées pour définir la chromaticité. Elles sont en corrélation, dans une certaine mesure, avec la tonalité et la saturation. Les coordonnées sont obtenues à partir des équations suivantes:

$$x = \frac{X}{X + Y + Z} \quad y = \frac{Y}{X + Y + Z}$$

Deux coordonnées suffisent (avec Y) pour définir une couleur étant donné que $x + y + z = 1$.

- Grade

The brand, proprietary or agreed upon name of the paper.

- Catégorie

Marque nominale, marque déposée ou désignation approuvée du papier.

- Type

Refers to a coated or uncoated stock.

- Reflectivity

It is the amount of light that is reflected from the paper surface that produces the observed brightness. It is obtained from the optical density using the following equation:

$$R = - \log \text{ density}$$

- Opacity

The property of paper that obstructs its light transmission and show through of printing.

- Print Contrast

This term is used as an indicator of how well the higher percentage tints are reproduced. It is defined by the following equation:

$$PC = \frac{\text{density}_s - \text{density}_{75}}{\text{density}_s} = 100\%$$

WHERE: PC . . . Print contrast
 density_s . . . Solid ink density
 density₇₅ . . . Density of the 75% tint

- Type

Renvoie au papier couché ou non couché.

- Pouvoir de réflexion (réflectivité)

Quantité de lumière réfléchiée par la surface du papier qui produit la brillance observée. Elle est calculée à partir de la densité optique à l'aide de l'équation suivante:

$$R = - \log \text{ densité}$$

- Opacité

Propriété du papier qui obstrue sa transmission de lumière et sa transparence.

- Contraste des impressions

Terme utilisé pour qualifier la mesure dans laquelle les teintes de pourcentage plus élevé sont reproduites. Le contraste est défini par l'équation suivante:

$$CI = \frac{\text{densité}_s - \text{densité}_{75}}{\text{densité}_s} = 100\%$$

OÙ: CI . . . Contraste des impressions
 densité_s . . . Densité de l'encre de la teinte plate
 densité₇₅ . . . Densité des teintes à 75%

- Plate Type

Designates the type of plate used to print the colour plates in this case, it is a pre-sensitized subtractive plate (as opposed to an additive plate) and negative working plate (as opposed to positive working).

- Densitometry

The channel selection refer to the filter position of the reflection densitometer which is the complimentary filter to the colour read.

The status refers to a given spectral response for Cyan (red), Magenta (green), Yellow (blue) as defined by ANSI PH 2.17.

- Aim Solid Density

This value represents the optimum density at the time of printing the colour plates. These values both wet (W/H) and dry (D/S) densities were tabulated from the colour control blocks and provide dry back information. Dry back refers to the change in density reading resulting from a change in gloss and hence a change in the spectral reflectance.

- Type de plaque

Désigne le type de plaque utilisé pour l'impression des planches colorimétriques. Il s'agit, dans ce cas, d'une plaque soustractive présensibilisée (par opposition à une plaque additive) et d'une plaque pour exposition négative (par opposition à une plaque pour exposition positive).

- Densitométrie

Sélection des canaux renvoyant à la position du filtre du densitomètre de réflexion qui est le filtre complémentaire de la couleur mesurée.

L'état renvoie à une réponse spectrale donnée pour la couleur cyan (rouge), magenta (vert) et jaune (bleu) définie par le PH ANSI 2.17.

- Densité de teinte plate visée

Valeur représentant la densité maximale au moment de l'impression des planches colorimétriques. Les valeurs de densité à l'état humide (W/H) et à l'état sec (D/S) ont été calculées à partir des cartons de contrôle des couleurs et fournissent des renseignements sur le virage. On entend par virage le changement de la lecture de densité dû à un changement de brillant et, par le fait même, à un changement du facteur de réflexion spectrale.

- Identification Patches

A major change of identifying the subtle colour patch differences has been adopted from the previous screen tint value system to an alphabetic system which will improve selection of colours by the users.

- % Screen

This represents tint screen values at the photographic stage of the reproduction. Their values will assist in assessing overall print capabilities.

- Density

Represents a printing densitometric density value of the alphabetic colour patch system. This is primarily used at the printing reproduction stage in the absence of colour control blocks, allowing an instant density reading of a minute colour segment of a particular tint.

- % Print

These values represent a specific set of conditions. Should anyone of these conditions change it will have a direct effect on the printed values.

- Blocs d'identification

Une modification importante dans la méthode d'identification des différences de nuances subtiles des échantillons de couleurs a été adoptée. Le système antérieur des trames à nuances a été remplacé par un système alphabétique qui facilite la sélection des couleurs par les utilisateurs.

- % de trame

Valeur représentant les nuances des trames à l'étape photographique de la reproduction et aidant à évaluer en général les moyens d'impression.

- Densité

Valeur représentant une valeur de densité mesurée par densitomètre des impressions du système alphabétique des échantillons de couleurs. Elle est avant tout utilisée à l'étape de reproduction des impressions, faite des cartons colorés, et permet d'obtenir une lecture de densité immédiate d'un segment de couleur minime d'une teinte particulière.

- % d'impression

Valeur représentant une série de conditions particulières. La modification de l'une quelconque de ces conditions influe directement sur les valeurs imprimées.

