



Energy, Mines and
Resources Canada

Énergie, Mines et
Ressources Canada

CANMET

Canada Centre
for Mineral
and Energy
Technology

Centre canadien
de la technologie
des minéraux
et de l'énergie

Manager, ELL

EQUIPMENT AND PROCEDURES TO DETERMINE GROUND STRESSES IN A SINGLE DRILL HOLE

G. Herget, P. Miles and W. Zawadski

SEPTEMBER 1977

MINERALS RESEARCH PROGRAM
MINING RESEARCH LABORATORIES
CANMET REPORT 78-11
LAB REPORT 78-109 (TR)

© Minister of Supply and Services Canada 1978

Available by mail from:

Printing and Publishing
Supply and Services Canada,
Ottawa, Canada K1A 0S9

CANMET
Energy, Mines and Resources Canada,
555 Booth St.,
Ottawa, Canada K1A 0G1

or through your bookseller.

Catalogue No. M38-13/78-11
ISBN 0-660-10007-x

Price: Canada: \$1.25
Other countries: \$1.50

Price subject to change without notice.

© Ministre des Approvisionnements et Services Canada 1978

En vente par la poste:

Imprimerie et Édition
Approvisionnement et Services Canada,
Ottawa, Canada K1A 0S9

CANMET
Énergie, Mines et Ressources Canada,
555, rue Booth
Ottawa, Canada K1A 0G1

ou chez votre libraire.

N° de catalogue M38-13/78-11
ISBN 0-660-10007-x

Prix: Canada: \$1.25
Autres pays: \$1.50

Prix sujet à changement sans avis préalable.

EQUIPMENT AND PROCEDURES TO DETERMINE GROUND
STRESSES IN A SINGLE DRILL HOLE

by

G. Herget*, P. Miles** and W. Zawadski***

SUMMARY

The ability to determine absolute stresses in rock becomes more significant as mining extends to greater depths. To fill a need for background information on ground stresses and to develop suitable equipment and procedures for stress determinations, the Mining Research Laboratories of the Canada Centre for Mineral and Energy Technology, in cooperation with Canadian mining companies, has developed expertise in determining stresses with the CSIR triaxial strain cell. A three-dimensional stress field can be determined using a single drill hole showing comparable success to the method employing the biaxial strain cell and three drill holes.

Testing procedures have been modified since the CSIR triaxial strain cell became commercially available in 1968. Successful modifications include changing from a nine-gauge triaxial cell to a 12-gauge cell, increasing diameter of the overcored hollow core cylinder, and using a glue which can tolerate moisture and an installing tool which operates without compressed air.

Procedures are reported for a variety of field conditions such as those adopted for installing triaxial strain cells in horizontal holes and vertical down holes. Routine testing in the laboratory to obtain the necessary physical properties of the rock and to assess quality of the strain gauge bond is described. Statistical selection criteria are given and a computer program provided to calculate the best fit stress tensor for four-gauge rosettes spaced at 120°.

* Research Scientist, ** Engineer and *** Technician, Elliot Lake Laboratory, Mining Research Laboratories, Canada Centre for Mineral and Energy Technology, Department of Energy, Mines and Resources, Elliot Lake, Ontario.

L'EQUIPEMENT ET LES PROCEDURES A SUIVRE AFIN DE
DETERMINER LES TENSIONS SOUTERRAINES DANS UN TROU DE MINE

par

G. Herget*, P. Miles** et W. Zawadski***

SOMMAIRE

Comme l'exploitation minière atteint de grandes profondeurs, il devient très important de pouvoir déterminer les tensions absolues dans les roches. Les Laboratoires de recherche minière du Centre canadien de la technologie des minéraux et de l'énergie en coopération avec les compagnies minières du Canada ont mis au point l'expertise nécessaire pour la détermination des tensions dans un trou de mine afin de subvenir au besoin de données de base sur les tensions du terrain et de mettre au point l'équipement et les procédures convenables pour la détermination de ces tensions.

Les procédures d'essais ont été modifiées depuis que la cellule de contrainte triaxiale CSIR fut introduite sur les marchés en 1968. Les modifications effectuées jusqu'à date incluent le remplacement d'une cellule triaxiale à neuf jauges par une cellule à douze jauges ainsi accroissant le diamètre du cylindre à carotte creuse et en employant une colle susceptible de tolérer l'humidité et un outil d'installation qui fonctionne sans air comprimé.

Les procédures sont employées selon différentes conditions des chantiers telles que celles qui ont été adoptées pour installer les cellules de contrainte triaxiale CSIR dans des trous horizontaux et des trous verticaux dirigés vers le bas. Le rapport décrit les essais de laboratoire effectués pour trouver les propriétés physiques des roches et évaluer la qualité de la liaison de l'extensiomètre. On retrouve aussi les critères de sélection et un programme d'ordinateur conçu afin de calculer le meilleur tenseur de contrainte pour les rosettes à quatre jauges distancées à 120° .

* Chercheur scientifique, ** Ingénieur et *** Technicien, Laboratoire d'Elliot Lake, Laboratoires de recherche minière, Centre canadien de la technologie des minéraux et de l'énergie, Ministère de l'Energie, des Mines et des Ressources, Elliot Lake, Ontario.

CONTENTS

Summary	i
Sommaire	ii
1. Introduction	1
2. Equipment and Field Testing Procedure	1
2.1 Testing Principle	1
2.2 Drilling of Required Hole Geometry	1
2.3 Installation of Strain Cells	4
3. Field Testing	6
4. Laboratory Testing	9
5. Ground Stress Tensor Analysis	11
6. Acknowledgements	15
7. References	16

TABLES

1. Testing equipment for elastic strain recovery measurements	3
2. Strain recovery from triaxial strain cell on 2800 level with CSIR tool	8
3. Determination of elastic modulus and Poisson's ratio from axial unloading of the overcored hollow core cylinder from 41.4 MPa to 27.6 MPa (6000 to 4000 psi)	10
4. Determination of elastic moduli and Poisson's ratios during unloading in radial compression tests	10
5. Estimated standard deviation for readings of similar gauge directions in triaxial strain cell	13
6. Stress tensor components from triaxial strain cell measurements, Timmins, Ontario	14
7. Magnitude and orientation of principal stresses from triaxial strain cell measurements, Timmins, Ontario	14

FIGURES

1. Geometry for CSIR triaxial strain cell overcoring technique	2
2. Drilling arrangement for collaring and drilling the EX hole at test site	3
3. Installing tool for triaxial strain cells	5
4. Wiring diagram for triaxial strain cell installing tool with four element strain gauge rosettes spaced at 120°	5

5.	Drill hole orientation for ground stress determinations with CSIR triaxial strain cell on 2800 level.	6
6.	Contoured polar plot of joints in 2800 exploration drift approximately 30 m (100 ft) north and south of test area	7
7.	Fieldsheet for recording of elastic strain recovery from 12-gauge triaxial strain cell	8
8.	PQ core obtained in hole No. T13	9
9a.	Equipment used for loading overcored hollow rock cylinders	12
9b.	Comparison of calculated and experimental stress relief during unloading of hollow core cylinder	12
10.	Principal stress direction (Azimuth/Plunge) from grid north in equal area net	15

APPENDIX

A	Ground stress tensor analysis	17
---	---	----

APPENDIX FIGURES

A - 1.	Coordinate system for triaxial strain cell	18
A - 2.	Strain gauge configuration for rosettes.	18

1. INTRODUCTION

Determination of ground stress is necessary for applying strength testing and failure theories to the rational design of excavations in rock. The major expense item for ground stress determination is the drilling of holes to install equipment and for overcoring. The triaxial strain cell developed by CSIR in South Africa has the advantage that only one drill hole is necessary to determine the complete ground stress tensor. Initial experience showed, however, that the rate of success was lower using the triaxial equipment than when using the biaxial or doorstopper equipment which requires three drill holes to obtain the complete stress tensor.

Experience from field tests has resulted in modifying the triaxial stress determination equipment and testing procedures. These are described for the benefit of potential users.

2. EQUIPMENT AND FIELD TESTING PROCEDURE

2.1 Testing Principle

The original equipment was designed by the Council for Scientific and Industrial Research, (CSIR), Pretoria, South Africa. The apparatus is described in detail in "Instruction Manual for the Use of the CSIR Triaxial Rock Stress Measuring Equipment" (1). In principle, strain gauges are glued on the wall of a 37.7-mm (1.5-in.) diameter borehole and read before and after overcoring. From the strain recovery measured in the field and from the elastic modulus and Poisson's ratio determined in the laboratory, a three-dimensional stress tensor can be calculated.

Originally the triaxial strain cell carried three rectangular gauge rosettes spaced at 0°, 90°, and 135° around the perimeter of an EX drill hole (2). Gray et al. showed that replacing the 3-gauge rosette by a 4-gauge rosette and spacing them 120° apart around the periphery would bring a marked improvement in standard error factors, and that the additional redundancy would improve accuracy of the best fit tensor calculation (3). The triaxial strain cell was modified

by the CSIR and is commercially available*.

2.2. Drilling of Required Hole Geometry

To install a triaxial strain cell, a standard H-size borehole of 99.21 mm (3.906 in.) diameter is drilled to the required depth (Fig. 1a). The end of this hole is ground flat with a suitable full-face diamond bit. An EX hole, 37.7 mm (1.5 in.) diameter, is then drilled into the end of and concentric with the H borehole for a distance of 45 cm (18 in.) (Fig. 1b). The core is removed, the EX hole is washed with water, sprayed with acetone, and dried with air. Then the triaxial strain cell containing three strain gauge rosettes is inserted into the EX portion of the borehole. The installing tool places the gauges 20 cm (8 in.) from the collar of the EX hole. A wedge activated by air pressure presses the strain rosettes against the inside of the EX hole (Fig. 1c). After the rosettes have been glued successfully to the borehole wall and stable readings recorded, the installing tool is removed from the borehole and the collar of the EX borehole is plugged. A cylinder about 50 cm (20 in.) long is then overcored by means of the H bit (Fig. 1d). The cylinder is removed from the borehole by special wedge and shovel equipment and elastic strain recovery is obtained by reconnecting the overcored test cell (Fig. 1e) to the installing tool and reading the gauges again. A list of field equipment is given in Table 1.

The bottom of the H hole must be ground flat to ensure proper collaring of the EX hole and to provide a flat collar for centering the installing tool in the EX hole. If the installing tool is not centered, the strain rosettes will be pushed at an oblique angle against the EX hole resulting in improper bonding.

The arrangement for drilling and centering the EX hole is shown in Fig. 2, (4). Guides with bearings can be used to steady the core barrel. A light, air driven, screw-fed JV diamond drill has no difficulty in drilling and overcoring to a

* W.H. Luwes, P.O. Box 718, Silverton, 0127 Transvaal, South Africa.

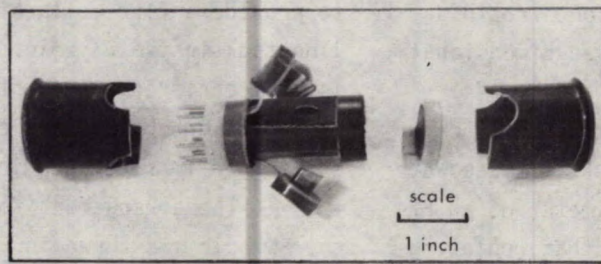
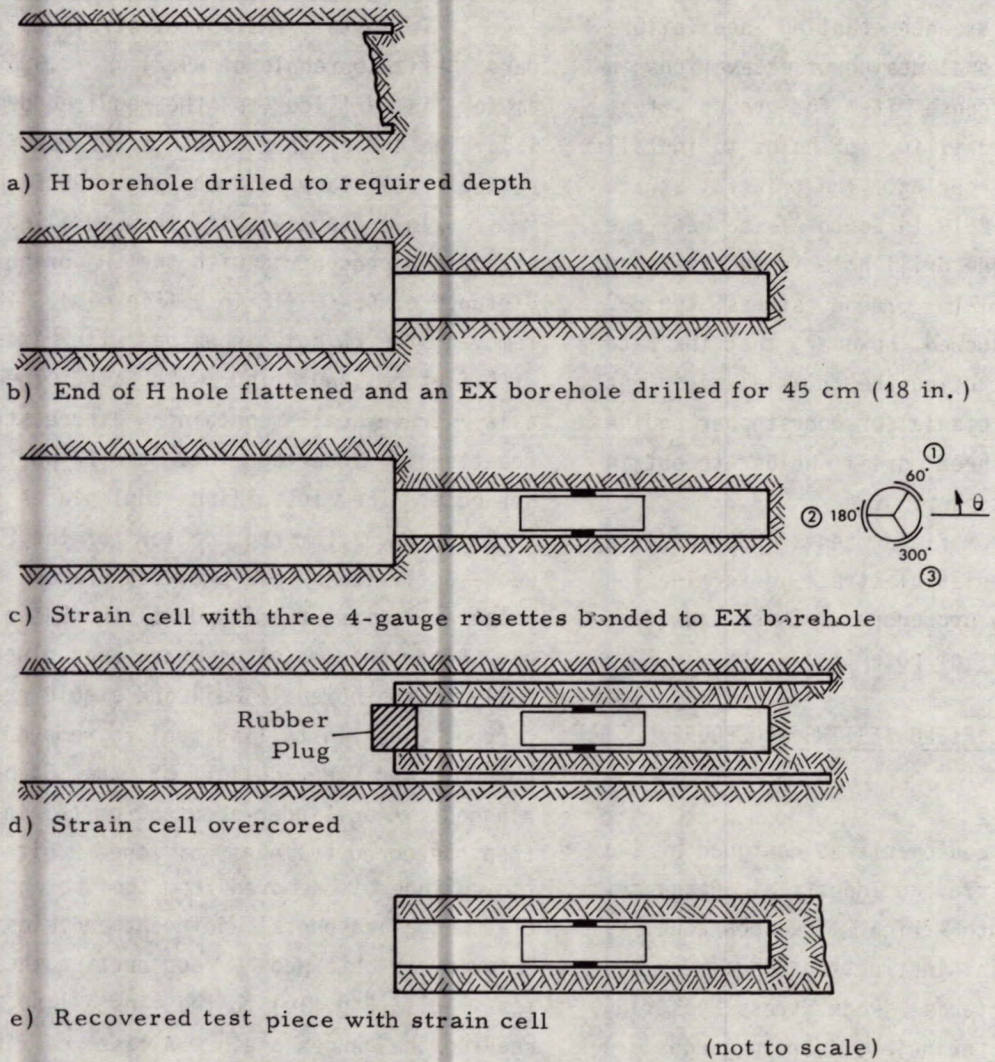

View of dismantled triaxial strain cell

Fig. 1 - CSIR triaxial strain cell overcoring technique and view of a dismantled triaxial strain cell

Table 1: Testing equipment for elastic strain recovery measurements

Electrical

- 20-m cable
- 12-position switch box
- Strain indicator
- 12-gauge triaxial cells

Cleaning and glueing

- Container with alcohol
- Container with acetone
- Plastic bag with Q-tips, mixing cups, paper towels, rags
- Cleaning tool for EX hole
- Philips resin and hardener
- Fleming resin and hardener

EX hole preparation

- Full face bit
- EX bits, adaptors, couplings
- 45-cm core barrel and reaming shell

Installation and recovery

- Installing tool and guide
- Rubber plug
- Retrieval shovel
- Wooden wedges
- Installing rods

Miscellaneous

- Electrician's tape, pencil, note-paper, Allen keys
- screwdriver, measuring tape

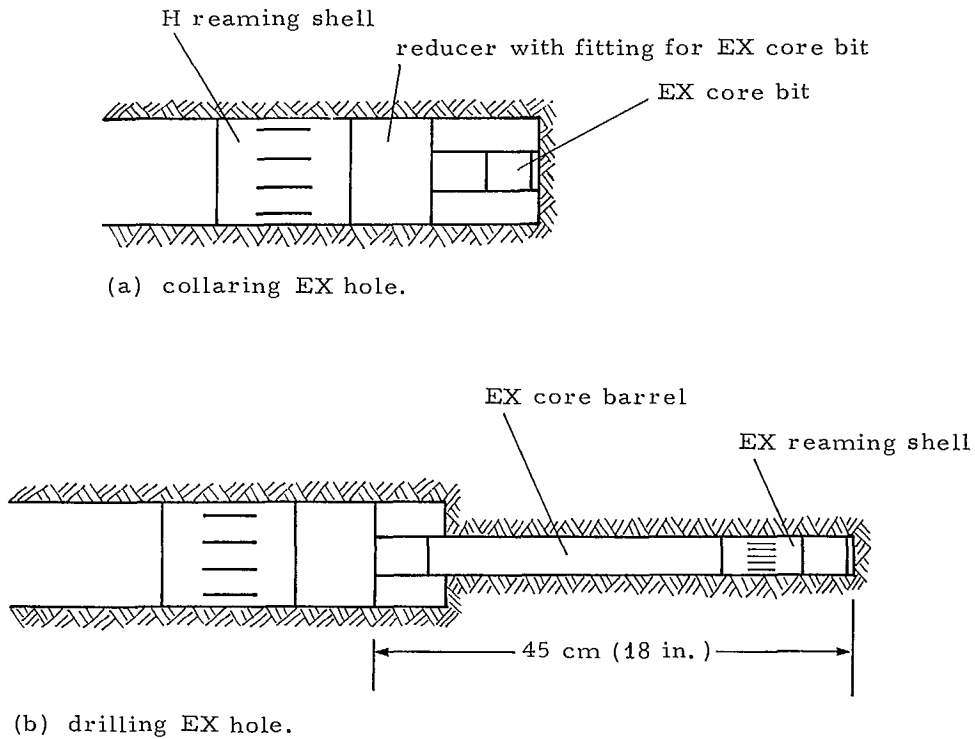

Fig. 2 - Drilling arrangement for collaring and drilling EX hole

depth of 12 m (40 ft).

In many cases, the hollow core cylinder broke during overcoring. To reduce this possibility two options are available:

- a. increase diameter of the overcored hollow core cylinder, or
- b. use a double or triple tube core barrel for overcoring.

Either method may be used, the only problems are to modify the centering device so that the centre of the large drill hole can be ground flat before collaring the EX hole and that the installation of the strain cell is possible.

The standard drill bit giving a core size larger than an H bit is the PQ bit with an OD of 122.7 mm (4.83 in.) and an approximate core diameter of 85.1 mm (3.35 in.). In one case, stress determinations were attempted in a bedded gypsum material and the overcoring of the installed triaxial strain cell was carried out with a 145-mm (5.7-in.) diameter core barrel. Overcoring in the friable material was so successful that a continuous piece 76.2 cm (30 in.) long was obtained.

The hollow core cylinders sometimes break because of geological discontinuities. To avoid test failures of this type, an inspection of the recovered EX core prior to installation of a strain cell can prove worthwhile.

The most convenient drill hole direction is 5° above the horizontal, allowing hole drainage and easy handling of drill rods. Experience has also been obtained with vertical up-holes and down-holes which both require special precautions for handling drill rods and core recovery. In vertical down-holes, a stand pipe or casing has to be sealed into place and the EX test hole extended beyond the required depth to provide a small sump.

2.3. Installation of Strain Cells

Bond between the rock surface and strain gauges has to be very good, especially as considerable force is required to detach the installing tool from the cell. Great care has therefore to be exercised when preparing and cleaning the hole for the cell installation. A good system involves pushing an EX aluminum rod into the EX borehole and washing the hole with water for a few minutes

to remove even the finest mud from the inside. Then the hole should be washed with acetone by means of a spray arrangement provided with the stress measuring equipment. Following this, compressed air can be blown in through a metal filter until the EX collar and hole are "white dry".

Philips quick-hardening strain gauge cement, PR9244/04, can be used in dry holes at room temperature, and a good bond is generally achieved in one hour when overcoring can begin. Time available for installation at room temperature is about two minutes but can change drastically with temperature. At near freezing temperatures, waiting periods can be longer than 2.5 hours.

Moist holes can create problems, but these can be avoided by using a strain gauge cement, Fleming* GC 104, which is more tolerant to moisture and sets successfully on a moist surface. Whereas the Philips cement requires one hour for setting at room temperature, the Fleming cement requires about three times as long.

The CSIR system of placing the strain gauge rosettes against the inside of the EX hole uses a wedge which is activated by air pressure (1). Air pressures of about 0.5 MPa (73 psi) are necessary. This requires that the system which pushes the strain gauge rosettes against the inside of the wall is checked before each installation and that sufficient air pressure is available to push a wedge into the triaxial strain cell. To do away with compressed air hoses and the need for a sufficiently high air pressure, a completely mechanical system of strain cell installation was developed in the Mining Research Laboratories of CANMET, as shown in Fig. 3, and has been used successfully. A wiring diagram showing switch positions and strain gauge orientations is given in Fig. 4.

Waterproofing of equipment is very important. The strain readings, both before and after overcoring, have to be obtained with completely dry electrical connections and equipment. Differences of up to 500×10^{-6} (cm/cm) were observed

* Fleming Services, 15 Coppice Avenue, Great Shelford, Cambridge, CB25AQ, England.

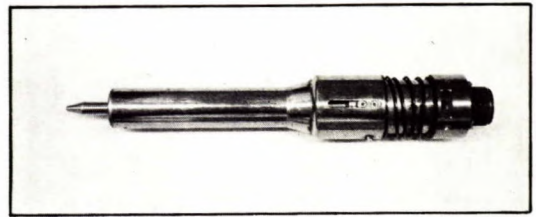

Top View of Installing Tool

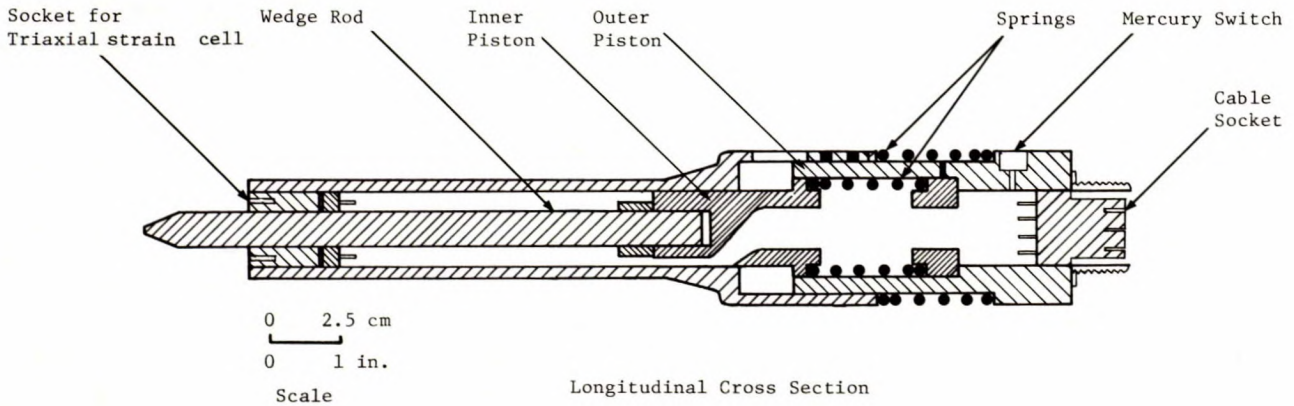

Fig. 3 - Installing tool for triaxial strain cells (wiring not shown)

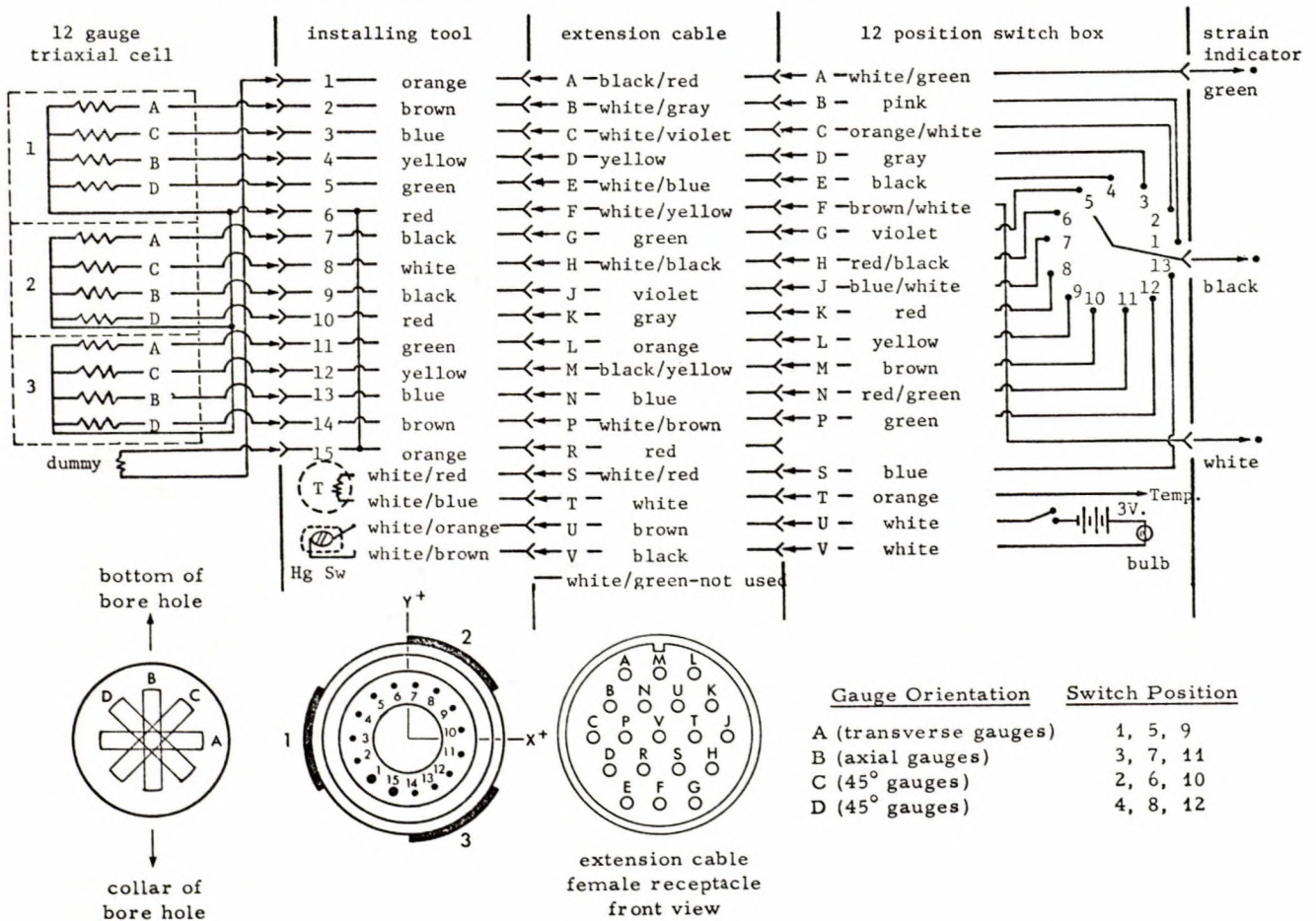

Fig. 4 - Wiring diagram for triaxial strain cell installing tool with four-element strain gauge rosettes spaced at 120°

with moist contacts. Water repellent grease on the contacts yielded good results. If the hollow core cylinder breaks during overcoring, it usually becomes soaked with fine mud and water. In this case the overcored strain cell has to be washed and strain readings after overcoring may be taken only when the cell is completely dry.

3. FIELD TESTING

Analysis of the ground stress tensor is based on the assumption that the material transmitting the stresses is homogeneous, isotropic, and elastic. Efforts must therefore be made to find rock formations where ideal rock properties are approached. Areas of intense fracturing and inhomogeneity, faults, shear zones, and rock contacts where the rock properties may vary considerably should thus be avoided. Tests in such areas are often spoiled because of numerous fractures.

In addition, the rapid change in ground stresses as one approaches or recedes from a fault zone makes reproducibility of strain recoveries in subsequent tests in the same drill hole difficult.

Ground stresses were determined in a mine at a depth of 853 m (2800 ft) below surface in a fine-grained andesite/diorite rock. The drill hole location and direction are given in Fig. 5; mine openings were about 4.25 m (14 ft) square. No faults were present in the vicinity of the test site and joint orientations are given in Fig. 6. Hole T13 was drilled at an inclination of about 5° above horizontal. The large hole was of PQ-size and the recovered core was approximately 85.1 mm (3.35 in.) in diameter. Drilling was done with a skid-mounted JV machine which required compressed air and water. Overcoring was carried out at a speed of 1 cm/min (0.4 in./min) and tests were performed at depths of 3 m (10 ft), 4.5 m (15 ft), 6 m (20 ft) and 7.5 m (25 ft).

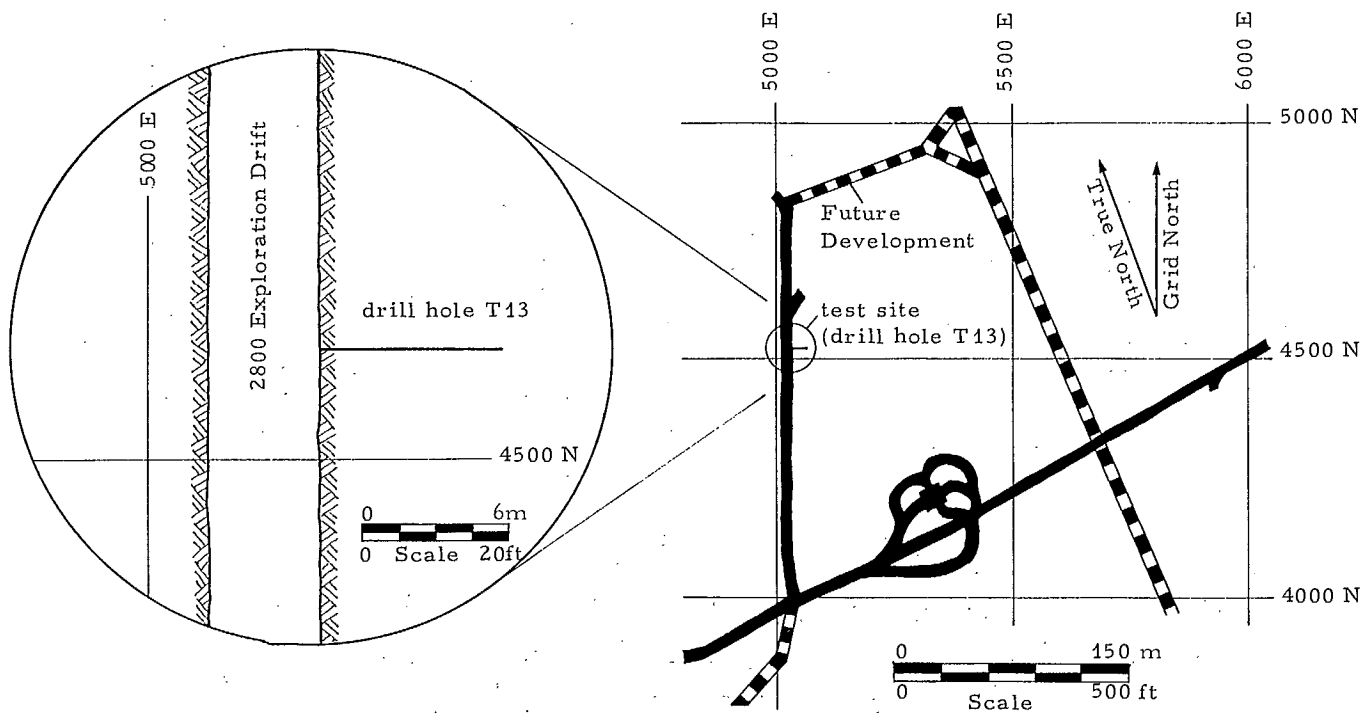

Hole No.	Collar Coordinates	Elevation	Azimuth ; Inclination	Diameter	Depth
T13	4515.3 N/5024.0 E	8126.69 ft	90° 00' 00" ; +4° 29' 33"	PQ	25 ft (7.6 m)

Fig. 5 - Drill hole orientation for ground stress determinations with CSIR triaxial strain cell on 2800 level

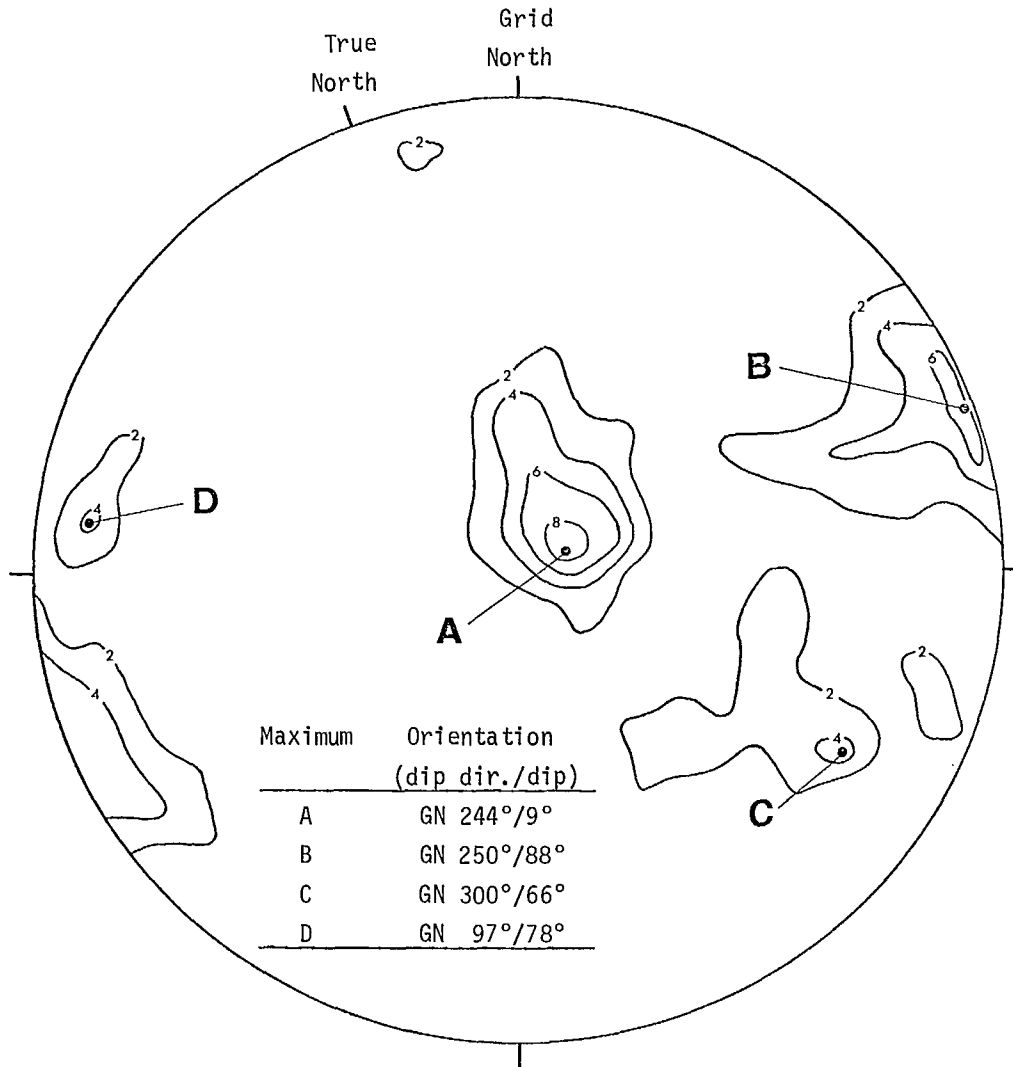

Fig. 6 - Contoured polar plot of joints in 2800 exploration drift approximately 30 m (100 ft) north and south of test area (contours in % per 1% area) (120 measurements)

A typical field sheet is given in Fig. 7 and a summary of the strain recoveries obtained is provided in Table 2. The core from drill hole T13 was photographed for future reference and is shown

in Fig. 8.

The hollow overcored cylinders were carefully brought to surface and shipped to the laboratory for further testing.

TRIAxIAL STRAIN CELL TEST DATA

Project: TG 1976		Location: 2800 L		Date: 10th May, 1976		Test No.: 13-2		Test Depth: 15ft					
Read Out Unit: Vishay		Cable: 60 ft		Installing Tool: C. S. I. R.		Cement: Philips		Installed by: W. Zawadski					
	Time	Strain gauge readings at switch positions:											
		1	2	3	4	5	6	7	8	9	10	11	12
Out of hole	10:00	11000	13900	14250	13900	12280	14440	13210	13760	11620	14200	14220	13740
Cell cemented	10:30	11520	13960	14340	13920	12245	14440	14220	14750	11580	14290	14350	13700
	11:45	11830	14020	14220	14085	12860	14570	14100	15270	11780	14340	14260	13790
	12:00	11840	14020	14220	14095	12840	14565	14105	15260	11780	14340	14255	13790
Pressure off	12:05	11840	14025	14220	14090	12840	14570	14105	15260	11780	14340	14255	13790
Cell overcored	12:30	12510	14215	14590	14925	13970	15485	14405	15710	12340	14840	14575	14180
	12:45	12500	14210	14595	14920	13940	15490	14395	15710	12340	14835	14580	14180
	1:00	12500	14215	14590	14935	13925	15490	14420	15705	12335	14835	14570	14170
	1:15	12490	14200	14580	14925	13940	15500	14390	15700	12335	14830	14565	14165
Strain difference		670	190	370	835	1130	915	300	450	560	500	320	390

Fig. 7 - Fieldsheet for recording of elastic strain recovery from 12-gauge triaxial strain cell

Table 2: Strain recovery from triaxial strain cell on 2800 level with CSIR tool

Test No.	Depth	Gauge Number											
		1	2	3	4	5	6	7	8	9	10	11	12
Hole No. T13, Azimuth; Grid North 90° 00' 00", Inclination; + 04° 29' 33"													
T13-1	3 m (10')	110	-370	-255	100	995	460	260	740	170	130	165	210
T13-2	4.5 m (15')	670	190	370	835	1130	915	300	450	560	500	320	390
T13-3	6 m (20')	785	230	310	830	990	850	325	565	165	590	460	255
T13-4	7.5 m (25')	360	-95	375	780	1180	1000	355	540	490	615	350	220

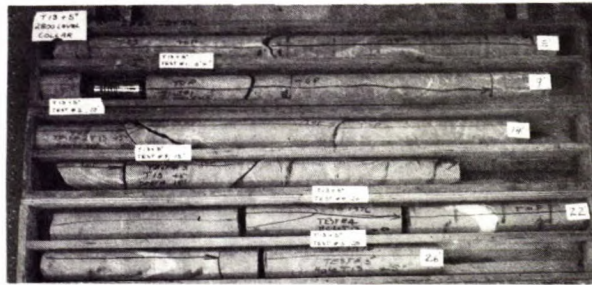

Fig. 8 - PQ core obtained in hole No. T13

4. LABORATORY TESTING

The overcored hollow rock cylinders were subjected to axial and radial loading in the laboratory to check that strain gauges were well bonded and to determine values of the elastic modulus, E , and Poisson's ratio, ν (4). For the analysis, the elastic constants must be obtained with precision similar to strain recoveries.

Hollow right circular cylinders having a length to diameter ratio of 3.0 and with ends ground parallel to within ± 0.04 mm (.0015 in.) were prepared from the overcored samples containing the strain cells. Each cylinder was axially loaded and unloaded in steps of 13.8 MPa (2000 psi) up to 41.4 MPa (6000 psi) and strain readings were recorded from the individual gauges.

As an indication of the bond between the cell and the rock, gauge response was checked for linearity and zero shift. Readings of the longitudinal and transversal gauges were used to calculate elastic moduli and Poisson's ratios for the interval between 41.4 MPa and 27.6 MPa (6000 and 4000 psi). Results are given in Table 3.

Following this, the hollow core cylinders were machined down to a diameter of 7.5 cm (3 in.) and loaded radially in a Hoek-Franklin triaxial cell. Each core was subjected to a radial stress of up to 27.6 MPa (4000 psi) and readings were obtained for each gauge at 6.9 MPa (1000 psi) intervals. Maximum applied pressure might have to be reduced depending on core strength.

Poisson's ratio was calculated for each load interval during unloading from the ratio of the longitudinal to the transversal strain. The elastic modulus during unloading can be calculated either with the aid of the three dimensional stress tensor analysis or from the three strain readings obtained at switch positions 1, 5, 9 and equation 1 (5):

$$E = - \frac{2aP_b b^2}{(b^2 - a^2)u} \quad \text{Eq 1}$$

E = modulus of elasticity

P_b = applied radial pressure at radius b

a = inside radius of hollow core cylinder

b = outside radius of hollow core cylinder

u = change in radius (borehole radius times strain ($a \cdot \epsilon$))

With $a = 0.75$ in., $b = 1.5$ in., $P_b = 1000$ psi and $u = 0.75\epsilon$, the elastic modulus can easily be calculated from the mean strains (ϵ) recorded by the transverse gauges 1, 5, 9:

$$E = - \frac{3375}{1.27\epsilon} = - \frac{2666.67}{\epsilon} \quad \text{Eq 2}$$

Strain readings from gauges 1, 5 and 9 were averaged for each stress interval of 6.9 MPa (1000 psi) during unloading and calculated elastic moduli are given in Table 4.

To use the best fit stress tensor analysis for calculating the elastic modulus, consideration has to be given to the hydraulic pressure which is

Table 3: Determination of elastic modulus and Poisson's ratio from axial unloading of the overcored hollow core cylinder from 41.4 MPa to 27.6 MPa (6000 to 4000 psi)

Sample no.	Elastic modulus MPa (10^6 psi)	Poisson's ratio
T13-1	86.8 (12.58)	0.13
T13-2	95.8 (13.89)	0.19
T13-3	96.5 (13.99)	0.34
T13-4	<u>81.6</u> (<u>11.83</u>)	<u>0.30</u>
Mean	90.1 (13.07)	0.24

Table 4: Determination of elastic moduli and Poisson's ratios during unloading in radial compression tests

Sample no.	Elastic modulus (1) MPa (10^6 psi)		Elastic modulus (2) MPa (10^6 psi)		Poisson's ratio
T13-1	82.6	(11.98)*	Specimen failed during loading		0.28*
T13-2	91.9	(13.33)	94.5	(13.69)	0.34
	90.4	(13.11)	90.2	(13.08)	0.24
	92.5	(13.42)	92.5	(13.41)	0.31
	<u>84.3</u>	<u>(12.23)</u>	<u>84.3</u>	<u>(12.22)</u>	<u>0.29</u>
	Mean	89.8 (13.02)	90.3	(13.10)	0.30
T13-3	92.5	(13.42)	94.8	(13.75)	0.30
	100.3	(14.55)	100.7	(14.60)	0.23
	91.9	(13.33)	93.2	(13.52)	0.33
	<u>97.8</u>	<u>(14.18)</u>	<u>93.1</u>	<u>(13.51)</u>	<u>0.33</u>
Mean	95.6 (13.87)	95.5	(13.85)	0.30	
T13-4	83.6	(12.12)	86.2	(12.50)	0.20
	75.2	(10.90)	75.8	(11.00)	0.26
	70.5	(10.22)	86.6	(12.56)	0.25
	<u>81.3</u>	<u>(11.80)</u>	<u>79.4</u>	<u>(11.52)</u>	<u>0.36</u>
Mean	77.7 (11.26)	82.1	(11.90)	0.27	

* obtained during loading cycle.

(1) According to Equation 1.

(2) According to tensor analysis.

not applied at infinity, but 1.91 cm (0.75 in.) from the EX drill hole. Due to the symmetry of the hydraulic loading system for the hollow core cylinder, a planar stress distribution for a single circular opening can be used to simplify the calculations. The stress distribution of the radial stress component in an infinitely thick core cylinder with a coaxial drill hole is defined as:

$$P_b = S_i \left(1 - \frac{a^2}{b^2} \right) \quad \text{Eq 3}$$

P_b = applied radial pressure at radius b
 a = inside radius of hollow core cylinder
 b = outside radius of hollow core cylinder
 S_i = stress at infinity

In the above laboratory test, the applied pressure of 6.9 MPa (1000 psi), was known and the radial stress applied at infinity was required. This is:

$$S_i = \frac{1000 \text{ psi}}{1 - \frac{0.75 \text{ in.}^2}{1.5 \text{ in.}^2}} = 1333.33 \text{ psi} \quad \text{Eq 4}$$

Using the strain readings obtained during radial unloading, the best fit stress tensor analysis would provide a stress of 1333.33 psi if the exact elastic modulus and Poisson's ratio were known and used. To determine the exact value for the elastic modulus, a tensor analysis is carried out with the laboratory strain readings and an estimate of the elastic modulus (e.g., 10×10^6 psi). Converting the obtained radial stresses X and Y to 1333.33 psi then allows determination of a correction factor for the estimated modulus.

The elastic moduli obtained by this procedure are given in Table 4. Table 4 shows that both elastic modulus determinations are nearly identical and to simplify the calculation process, the elastic modulus should be calculated according to Equation 1. The elastic modulus (Equation 1) and Poisson's ratio obtained during radial testing were chosen as the most representative for the stress tensor calculation. Figure 9a shows the equipment used for loading the overcored hollow

rock cylinders. A graph is presented in Fig. 9b to show how well the best fit stress tensor analysis can calculate actual stresses from mean elastic constants and strain readings during unloading. Also shown is a comparison between experimentally applied and calculated stresses under laboratory conditions for radial unloading.

5. GROUND STRESS TENSOR ANALYSIS

Obvious test failures occur in the field and may involve poor cell installation, malfunction of strain gauge circuits and instruments, and cracking of rock samples. Additional rejections may occur during mechanical quality testing in the laboratory. Even so, overcored strain gauges which performed satisfactorily in the laboratory might have recorded "wild" outliers of strain recovery, which relate to partially relaxed rock in a shear zone or to extreme stresses in the vicinity of a fracture. Statistical screening of results is therefore necessary before they are admitted to the pool of strain recovery data for stress tensor analysis. Following a suggestion by Gray et al, this can be done by comparing the standard deviations of groups of similar observations (6). A quick way to do this is to divide the range of such observations by a value, d_n , given by Davies (7, p 378). Some values of d_n are:

No. of observations	2	3	4	5	6	7
d_n	1.1	1.7	2.1	2.3	2.5	2.7

A mean standard deviation for all groups can be obtained and group standard deviations can then be examined as to whether or not they are consistent with it. An example is given below for a 9-gauge triaxial strain cell where gauges 1, 4, and 7 are parallel and point in the axial direction.

In a group of strain recovery readings obtained in holes C1 and C2, the standard deviation of strain recovery readings for gauges of similar orientation showed large variations compared with

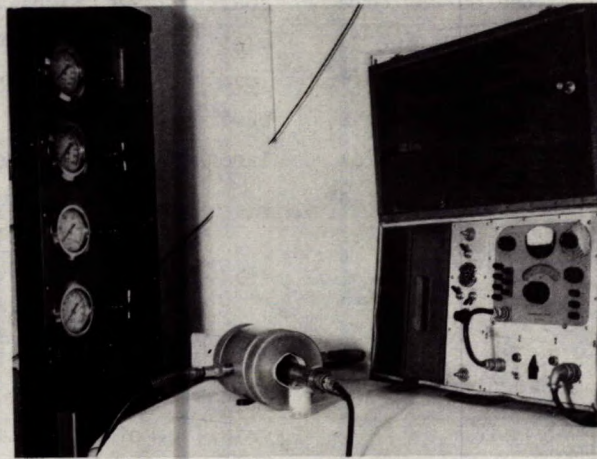

Fig. 9a - Equipment for loading overcored hollow rock cylinders

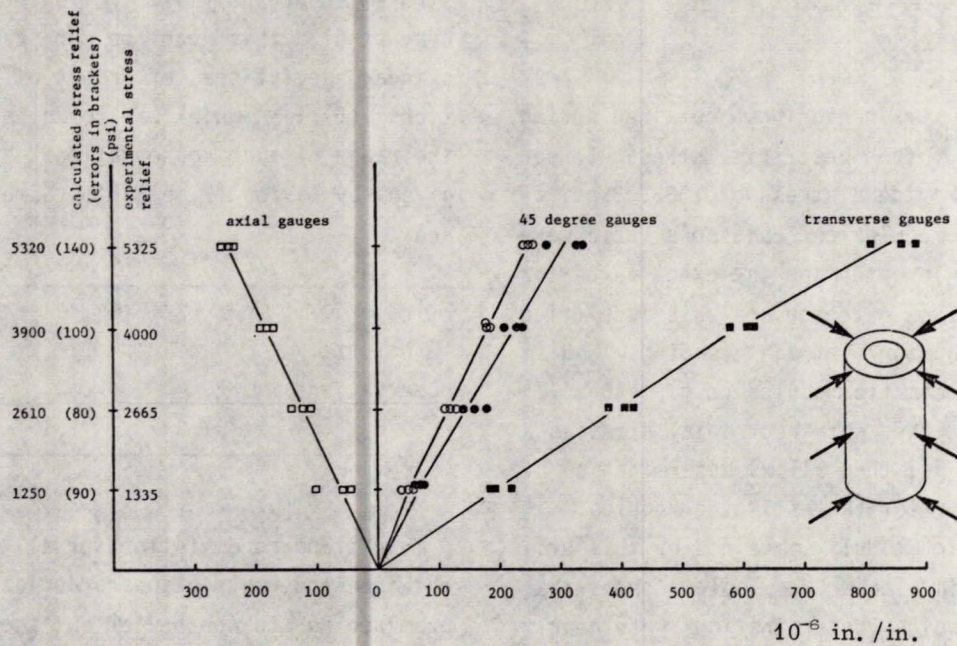

Fig. 9b - Comparison of calculated and experimental stress relief during unloading of hollow core cylinder (T13-3, $E = 13.02$, $\nu = 0.30$)

the mean standard deviation for the whole group as shown in Table 5. Strain readings for gauges 1, 4 and 7 in hole C1 showed a standard deviation of 816 compared with the mean standard deviation of $\bar{s} = 300$ for the whole group. Within the C1 group, gauges 1, 4 and 7 included the observations: 300, 2150, 220, 755, 110, and 335. The reading 2150 is easily recognized as an extreme observation which can be proven by a t-test.

Sub-Group 1

2150

$$\bar{x}_1 = 2150$$

$$n_1 = 1$$

$$t = \frac{\bar{x}_1 - \bar{x}_2}{\bar{s}\sqrt{(1/n_1 + 1/n_2)}}$$

Sub-Group 2

300

220

755

110

335

$$\bar{x}_2 = 344$$

$$n_2 = 5$$

$$t = \frac{2150 - 344}{300\sqrt{(1.2)}} = 5.50$$

Total observations = 30 Degrees of freedom (ϕ)
= 30 - 12 = 18

For $\phi = 18$, $t(0.005) = 2.88$. As $2.88 < 5.50$, the value 2150 can be rejected as being significantly different at the 1% confidence level. After rejecting the outlying observation, the estimate of the standard deviation is reduced to 280.

After screening, the acceptable strain recovery readings can be compiled and using the appropriate elastic modulus and Poisson's ratio, the stress tensor can be calculated. The computer program for analyzing the ground stress tensor is described in Appendix 1 for the 12-gauge triaxial strain cell. Results using this program are reported in the form of stress tensor components and their error in relation to the drill hole orientation in Table 6 and principal stresses, orientations, and magnitudes in Table 7. Figure 10 shows

Table 5: Estimated standard deviation of readings of similar gauge directions in triaxial strain cell

Hole	Gauges	Range of Observations	No. of Observations	d_n	STDV	
C1	1, 4, 7	2040	6	2.5	816	
	2	470	2	1.1	427	
	3	575	2	1.1	523	
	5	295	2	1.1	268	
	6	180	2	1.1	164	
	8	15	2	1.1	14	
	9	585	2	1.1	532	
	C2	1, 4, 7	145	4	2.1	69
		2	230	2	1.1	209
3		450	2	1.1	409	
5		45	2	1.1	41	
6		140	2	1.1	127	
8		-	-	-	-	
9		-	-	-	-	
Mean(\bar{s})					300	
STDV					245	

Table 6: Stress tensor components from triaxial strain cell measurements, Timmins, Ontario

Test no.	Elastic modulus (10 ⁶ psi)	Poisson's ratio	Stress components in psi (standard error in brackets) ⁽¹⁾						(2) q (10 ⁵)	STDV
			σ_x	σ_y	σ_z	τ_{xy}	τ_{yz}	τ_{zx}		
T13-1	11.98	0.28	4180 (890)	1310 (890)	2040 (1460)	-1570 (520)	-450 (640)	-270 (640)	33.93	237
T13-2	13.02	0.30	6640 (140)	5920 (140)	7990 (220)	-1110 (80)	-1560 (100)	510 (100)	0.65	33
T13-3	13.87	0.30	5710 (400)	6290 (400)	8990 (650)	-1630 (230)	-1620 (280)	-80 (280)	4.84	90
T13-4	11.26	0.27	5650 (40)	3690 (40)	6530 (70)	-1220 (20)	-1920 (30)	80 (30)	0.08	11

- (1) x,y,z, are coordinates of an orthogonal right handed coordinate system.
 z^+ is parallel to the drill hole direction and points towards the collar.
 x^+ is on right hand side when looking down the drill hole.
 y^+ is vertical.

- (2) Residual sum of squares.

Table 7: Magnitude and orientation of principal stresses from triaxial strain cell measurements, Timmins, Ontario

Test no.	Depth m (ft)	σ_1 MPa (psi)	Orientation (Azimuth/plunge)	σ_2 MPa (psi)	Orientation (Azimuth/plunge)	σ_3 MPa (psi)	Orientation (Azimuth/plunge)
T13-1	3 (10)	33.7 (4890)	GN 177°/08°	15.2 (2210)	GN 086°/14°	3.1 (450)	GN 293°/75°
T13-2	4.5 (15)	63.5 (9210)	GN 052°/10°	45.4 (6580)	GN 144°/16°	32.8 (4760)	GN 288°/72°
T13-3	6 (20)	67.9 (9850)	GN 066°/16°	48.6 (7050)	GN 335°/10°	28.1 (2370)	GN 216°/72°
T13-4	7.5 (25)	53.2 (7710)	GN 57°/12°	39.9 (5780)	GN 150°/18°	16.3 (2370)	GN 298°/70°

NOTE: GN (Grid North) is 20° east of true north (in this particular case the triaxial cells were installed with x^+ = 30° above horizontal, y^+ = 30° counter clockwise from vertical).

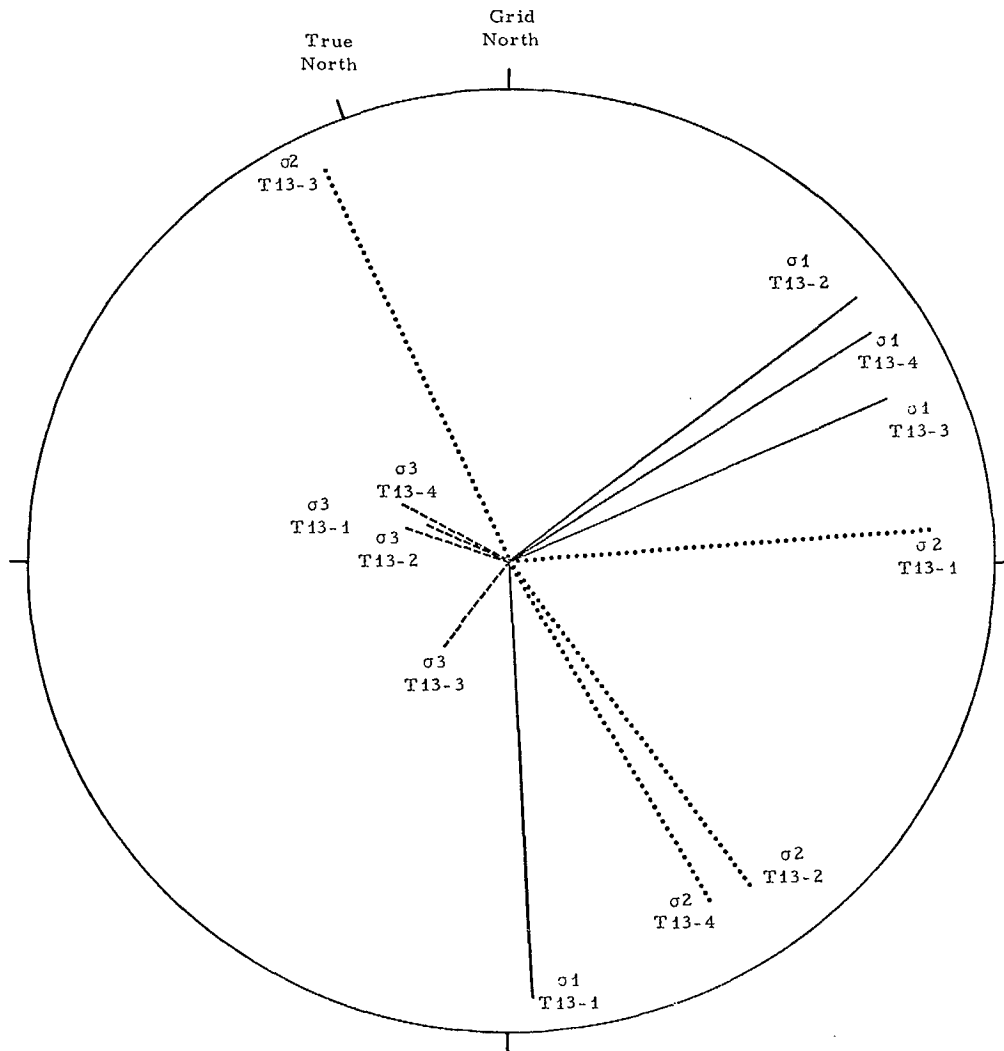

Fig. 10 - Principal stress direction (Azimuth/Plunge) from grid north in equal area net

the magnitude and the orientation of the principal stresses in the lower hemisphere projection of an equal area net.

6. ACKNOWLEDGEMENTS

Various mining companies assisted the pro-

gram considerably by providing drillers, drilling rigs, strain cells, and accommodation for field officers.

The new installing tool was designed and built by personnel of CANMET's Elliot Lake Laboratory.

7. REFERENCES

1. CSIR "Instruction manual for the use of the CSIR triaxial rock stress measuring equipment"; CSIR report, MER/243, MER 4406, MEG 677, Council for Scientific and Industrial Research, Pretoria; 1968.
2. Leeman, E.R. "The doorstopper and triaxial rock stress measuring instruments developed by the CSIR"; J South African Inst Min Met; v. 69, pp 305-339; 1969.
3. Gray, W.M. and Toews, N.A. "Optimization of the design and use of a triaxial strain cell for stress determination"; ASTM Symposium on Field Testing and Instrumentation of Rock; June 1973.
4. Herget, G. "First experience with the CSIR triaxial strain cell for stress determinations"; Int J Rock Mech Min Sci & Geomech Abst; v. 10, pp 509-522; 1973.
5. Fitzpatrick, J. "Biaxial device for determining the modulus of elasticity of stress relief cores"; Bureau of Mines RI 6128; 1962.
6. Gray, W.M. and Barron, K. "Stress determination from strain relief measurements on the ends of boreholes; planning, data evaluation, and error assessment"; Proc Int Symp on Determination of Stresses in Rock Masses; Lisbon, Portugal; 1969.
7. Davies, O.L. "Statistical methods in research and production"; Oliver and Boyd, London; pp 396; 1967.

APPENDIX 1

GROUND STRESS TENSOR ANALYSIS

W.M. Gray and N.A. Toews (1973) determined the strain equations for each gauge direction in four-gauge rosettes spaced at 120° around the circumference of the strain cell. The coordinate

axes and gauge orientation are shown in Fig. A-1 and A-2. The strain equations are reproduced below:

Rosette 1 ($\theta = \pi$)

$$e_{1A} = C_1 M_{11} + C_2 M_{22} + C_3 M_{33} \quad (1a)$$

$$e_{1B} = C_2 M_{11} + C_4 M_{22} + C_2 M_{33} \quad (1b)$$

$$e_{1C} = C_5 M_{11} + C_6 M_{22} + C_7 M_{33} + 4C_8 M_{12} \quad (1c)$$

$$e_{1D} = C_5 M_{11} + C_6 M_{22} + C_7 M_{33} - 4C_8 M_{12} \quad (1d)$$

Rosette 2 ($\theta = \pi/3$)

$$e_{2A} = (1/4) (C_1 + 3C_3) M_{11} + C_2 M_{22} + (1/4) (3C_1 + C_3) M_{33} - (\sqrt{3}/2) (C_1 - C_3) M_{31} \quad (2a)$$

$$e_{2B} = C_2 M_{11} + C_4 M_{22} + C_2 M_{33} \quad (2b)$$

$$e_{2C} = (1/4) (C_5 + 3C_7) M_{11} + C_6 M_{22} + (1/4) (3C_5 + C_7) M_{33} + 2\sqrt{3} C_8 M_{23} - (\sqrt{3}/2) (C_5 - C_7) M_{31} - 2C_8 M_{12} \quad (2c)$$

$$e_{2D} = (1/4) (C_5 + 3C_7) M_{11} + C_6 M_{22} + (1/4) (3C_5 + C_7) M_{33} - 2\sqrt{3} C_8 M_{23} - (\sqrt{3}/2) (C_5 - C_7) M_{31} + 2C_8 M_{12} \quad (2d)$$

Rosette 3 ($\theta = 5\pi/3$)

$$e_{3A} = (1/4) (C_1 + 3C_3) M_{11} + C_2 M_{22} + (1/4) (3C_1 + C_3) M_{33} + (\sqrt{3}/2) (C_1 - C_3) M_{31} \quad (3a)$$

$$e_{3B} = C_2 M_{11} + C_4 M_{22} + C_2 M_{33} \quad (3b)$$

$$e_{3C} = (1/4) (C_5 + 3C_7) M_{11} + C_6 M_{22} + (1/4) (3C_5 + C_7) M_{33} - 2\sqrt{3} C_8 M_{23} + (\sqrt{3}/2) (C_5 - C_7) M_{31} - 2C_8 M_{12} \quad (3c)$$

$$e_{3D} = (1/4) (C_5 + 3C_7) M_{11} + C_6 M_{22} + (1/4) (3C_5 + C_7) M_{33} + 2\sqrt{3} C_8 M_{23} + (\sqrt{3}/2) (C_5 - C_7) M_{31} + 2C_8 M_{12} \quad (3d)$$

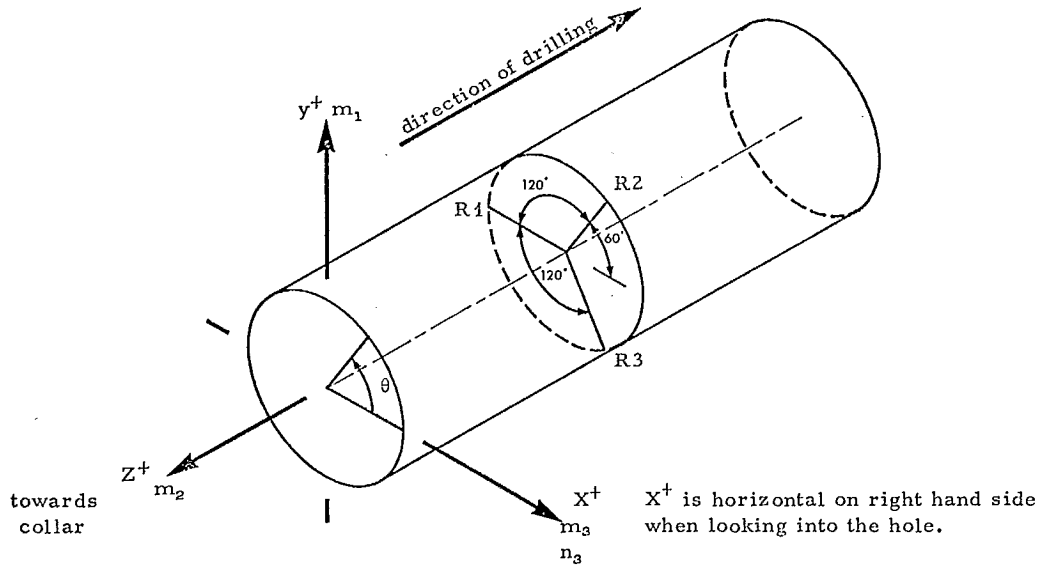

Fig. A-1 - Coordinate systems for triaxial strain cell

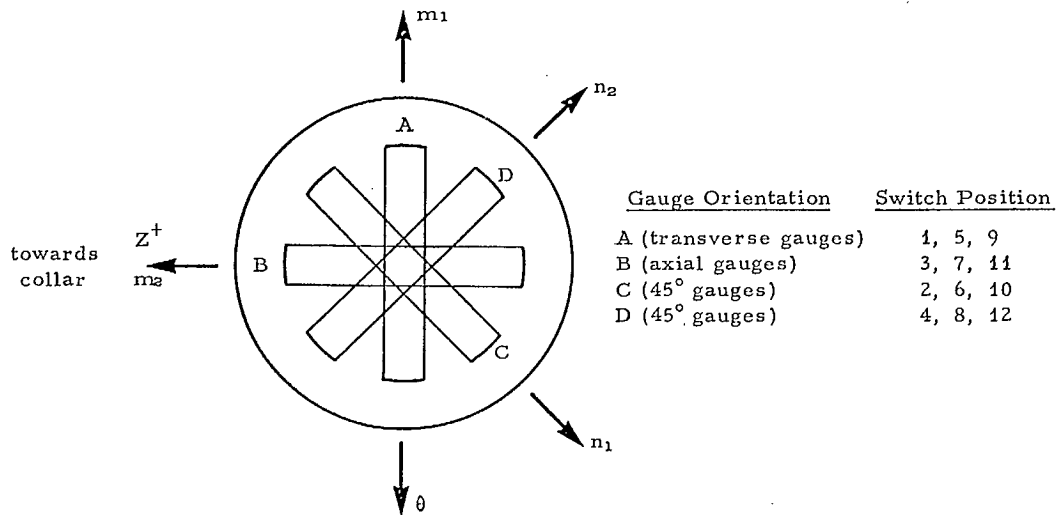

Fig. A-2 - Strain gauge configuration for rosettes. (Axes m_1, m_2, n_1, n_2 refer to rosette No. 1 only. Axes n_1, n_2, n_3 are introduced to obtain strains measured by gauges C and D of rosette No. 1)

M_{ij} are the stress components relative to the axes m_1, m_2, m_3 , equivalent to Leeman's Y, Z, X respectively, and C_i are strains measured in directions as shown by Fig. A-2.

$$\begin{aligned} C_1 &= (3-2\nu^2)/E & C_2 &= -\nu/E \\ C_3 &= -(1-2\nu^2)/E & C_4 &= 1/E \\ C_5 &= (1-\nu)(3+2\nu)/E & C_6 &= (1-\nu)/2E \end{aligned}$$

$$C_7 = -(1-\nu)(1+2\nu)/2E \quad C_8 = (1+\nu)2E$$

Where E is Young's modulus and ν is Poisson's ratio for the rock.

A computer program has been written which applies the above equations. The least squares solution provides tensor components and their errors, residual sum of squares, and the standard deviation about the regression line. A printout is attached. Principal stresses are calculated with eigenvalue analysis.

COMPUTER PROGRAM TRIAX12

```

TRIAX12      11:06   12/29/77  THURSDAY   370

100 REM PROGRAM CALCULATES STRESS TENSOR OF BEST FIT AND STANDARD
110 REM ERROR OF TENSOR COMPONENTS FROM 12 MEASUREMENTS OF STRAIN
120 REM RECOVERY WITH CSIR 120 DEGREE TRIAXIAL STRAIN CELL.
130 REM ORTHOGONAL COORDINATES ARE RELATED TO DRILL HOLE: Z+ IS
140 REM PARALLEL TO DRILL HOLE AND POINTS TOWARDS COLLAR, X+ IS
150 REM HORIZONTAL, AND ON LEFT HAND SIDE WHEN LOOKING IN Z+ DIR-
160 REM ECTION, Y+ IS AT RIGHT ANGLES TO Z+ AND X+. ROSETTE 1 IS
170 REM VERTICAL. GAUGES 3, 7, 11 HAVE LONGITUDINAL AND 1, 5, 9 HAVE
180 REM TRANSVERSAL DIRECTION TO DRILL HOLE. INPUT FOR STRAIN READ-
190 REM INGS ACCORDING TO SWITCH POSITIONS 1 TO 12.
200 REM HERGET-CALL/360/BASIC-JULY 76.
210 DIM U(13), F(6,6), Z(6,6), C(13,36), D(13,6), T(6,7), E(6), H(6), B(6)
220 E=5.11
230 R=.26
240 PRINT "ELASTIC MODULUS (1000000 PSI) AND POISS. RATIO"
250 PRINT E,R
260 C1=(3-2*R^2)/E
270 C2=-R/E
280 C3=-(1-2*R^2)/E
290 C4=1/E
300 C5=(1-R)*(3+2*R)/(2*E)
310 C6=(1-R)/(2*E)
320 C7=-(1-R)*(1+2*R)/(2*E)
330 C8=(1+R)/(2*E)
340 PRINT "STRAIN READINGS U1 TO U12 IN 0.000001 IN./IN."
350 FOR I=1 TO 12
360 READ U(I)
370 PRINT U(I)
380 DATA 375, -95, 365, 780, 1160, 1000, 350, 535, 480, 615, 345, 220
390 GOTO 430, 600, 670, 740, 810, 880, 670, 950, 1020, 1090, 670, 1160, ON I
400 NEXT I
410 GOTO 1240
420 REM CALCULATION OF COEFFICIENTS A1 TO A6
430 A(1)=C1
440 A(2)=C2
450 A(3)=C3
460 A(4)=0
470 A(5)=0
480 A(6)=0
490 REM CALCULATION OF COEFFICIENTS FOR LEAST SQUARE SOLUTION
500 FOR J=1 TO 6
510 FOR L=1 TO 6
520 M=6*(J-1)+L
530 C(I,M)=A(J)*A(L)
540 NEXT L

```

```

550 NEXT J
560 FOR J=1 TO 6
570 D(I,J)=U(I)*A(J)
580 NEXT J
590 GO TO 400
600 A(1)=C5
610 A(2)=C6
620 A(3)=C7
630 A(4)=4*C8
640 A(5)=0
650 A(6)=0
660 GO TO 500
670 A(1)=C2
680 A(2)=C4
690 A(3)=C2
700 A(4)=0
710 A(5)=0
720 A(6)=0
730 GO TO 500
740 A(1)=C5
750 A(2)=C6
760 A(3)=C7
770 A(4)=-4*C8
780 A(5)=0
790 A(6)=0
800 GO TO 500
810 A(1)=0.25*(C1+3*C3)
820 A(2)=C2
830 A(3)=0.25*(3*C1+C3)
840 A(4)=0
850 A(5)=0
860 A(6)=- (3+0.5)*(C1-C3)/2
870 GO TO 500
880 A(1)=0.25*(C5+3*C7)
890 A(2)=C6
900 A(3)=0.25*(3*C5+C7)
910 A(4)=-2*C8
920 A(5)=2*3+0.5*C8
930 A(6)=- (3+0.5)*(C5-C7)/2
940 GO TO 500
950 A(1)=0.25*(C5+3*C7)
960 A(2)=C6
970 A(3)=0.25*(3*C5+C7)
980 A(4)=2*C8
990 A(5)=- (3+0.5)*2*C8
1000 A(6)=- (3+0.5)*(C5-C7)/2
1010 GO TO 500
1020 A(1)=0.25*(C1+3*C3)
1030 A(2)=C2
1040 A(3)=0.25*(3*C1+C3)
1050 A(4) = 0
1060 A(5)=0
1070 A(6)=3+0.5*(C1-C3)/2
1080 GO TO 500
1090 A(1)=0.25*(C5+3*C7)
1100 A(2) = C6
1110 A(3)=0.25*(3*C5+C7)
1120 A(4)=-2*C8
1130 A(5)=-2*3+0.5*C8
1140 A(6)=3+0.5*(C5-C7)/2
1150 GO TO 500
1160 A(1)=0.25*(C5+3*C7)
1170 A(2) = C6
1180 A(3)=0.25*(3*C5+C7)
1190 A(4)=2*C8
1200 A(5)=2*3+0.5*C8
1210 A(6)=3+0.5*(C5-C7)/2
1220 GO TO 500
1240 FOR M=1 TO 36

```

```

1250 FOR N=1 TO 12
1260 C(13,M)=C(13,M)+C(N,M)
1270 NEXT N
1280 NEXT M
1290 FOR M=1 TO 6
1300 FOR N=1 TO 12
1310 D(13,M)=D(13,M)+D(N,M)
1320 NEXT N
1330 NEXT M
1340 FOR I=1 TO 6
1350 FOR N=1 TO 6
1360 M=6*(I-1)+N
1370 F(I,N) = C(13,M)
1380 NEXT N
1390 NEXT I
1400 REM SOLUTION OF FINAL SET OF EQUATIONS BY MATRIX INVERSION
1410 MAT Z=INV(F)
1420 PRINT "TENSOR COMPONENTS Y,Z,X,YZ,ZX,XY"
1430 FOR L=1 TO 6
1440 FOR J=1 TO 6
1450 T(L,J) = Z(L,J) * D(13,J)
1460 T(L,7)=T(L,7)+T(L,J)
1470 NEXT J
1480 PRINT T(L,7)
1490 NEXT L
1500 FOR N=1 TO 12
1510 U(13) = U(13) + U(N) ↑ 2
1520 NEXT N
1530 FOR N=1 TO 6
1540 H(N)=Z(N,N)↑.5
1550 NEXT N
1560 FOR N=1 TO 6
1570 E(N) = T(N,7) * D(13,N)
1580 NEXT N
1590 Q = U(13) - (E(1)+E(2)+E(3)+E(4)+E(5)+E(6))
1600 PRINT "RESIDUAL SUM OF SQUARES"
1610 PRINT Q
1620 S = (Q/(12-6)) ↑ .5
1630 PRINT"STANDARD DEVIATION ABOUT FITTED REGRESSION LINE"
1640 PRINT S
1650 PRINT"STANDARD ERROR FOR TENSOR COMPONENTS"
1660 FOR N=1 TO 6
1670 B(N)=S*H(N)
1680 PRINT B(N)
1690 NEXT N
1700 END

```

RUN

TRIAX12 12:41 01/03/78 TUESDAY T01

ELASTIC MODULUS (1000000 PSI) AND POISS. RATIO

5.11 .26

STRAIN READINGS U1 TO U12 IN 0.000001 IN./IN.

375

-95

365

780

1160

1000

350

535

480

615

345

220

TENSOR COMPONENTS Y,Z,X,YZ,ZX,XY

1663.29

2882.

2509.72

-882.083

40.976

-543.181

RESIDUAL SUM OF SQUARES

1041

STANDARD DEVIATION ABOUT FITTED REGRESSION LINE

13.1719

STANDARD ERROR FOR TENSOR COMPONENTS

20.881

34.1328

20.881

15.4209

15.4209

12.0314

CANMET REPORTS

Recent CANMET reports presently available or soon to be released through Printing and Publishing Supply and Services, Canada (addresses on inside front cover), or from CANMET Publications Office, 555 Booth Street, Ottawa, Ontario K1A 0G1:

Les récents rapports de CANMET, qui sont présentement disponibles ou qui ce seront bientôt peuvent être obtenus de la direction de l'Imprimerie et de l'Édition, Approvisionnement et Services, Canada (adresses au verso de la page couverture), ou du Bureau de Vente et distribution de CANMET, 555 rue Booth, Ottawa, Ontario, K1A 0G1:

- 77-14 Pit slope manual - Chapter 7 - Perimeter blasting; P. Calder;
Cat. No. M38-14/7-1977, ISBN 0-660-01011-9; Price: \$2.25 Canada, \$2.70 other countries.
- 77-16 Pit slope manual - Supplement 5-1 - Plane shear analysis; D.F. Coates;
Cat. No. M38-14/5-1977-1, ISBN 0-660-01008-9; Price: \$4.25 Canada, \$5.10 other countries.
- 77-19 Pit slope manual - Supplement 2-2 - Domain analysis programs; D. Cruden and J. Ramsden;
Cat. No. M38-14/2-1977-2, ISBN 0-660-00990-0; Price: \$3.75 Canada, \$4.50 other countries.
- 77-23 Pit slope manual - Supplement 2-4 - Joint mapping by terrestrial photogrammetry; G. Herget;
Cat. No. M38-14/2-1977-4, ISBN 0-660-00992-7; Price: \$2.50 Canada, \$3.00 other countries.
- 77-24 Pit slope manual - Supplement 2-5 - Structural geology case history; G. Herget;
Cat. No. M38-14/2-1977-5, ISBN 0-660-00993-5; Price: \$2.75 Canada, \$3.30 other countries.
- 77-30 Pit slope manual - Supplement 4-1 - Computer manual for seepage analysis; J. Marlon-Lambert;
Cat. No. M38-14/4-1977-1, ISBN 0-660-01007-0; Price: \$3.50 Canada, \$4.20 other countries.
- 77-31 Pit slope manual - Supplement 10-1 - Reclamation by vegetation - Vol. 1 - Mine waste description and case histories; D. Murray;
Cat. No. M38-14/10-1977-1, ISBN 0-660-01013-5; Price: \$3.50 Canada, \$4.20 other countries.
- 77-47 Statistical correlation of ASTM and JIS coke tumbler test results; W.R. Leeder and K.A. Jonasson;
Cat. No. M38-13/77-47, ISBN 0-660-01705-9; Price: \$1.25 Canada, \$1.50 other countries.
- 77-56 Corrosion protection and lateral displacement characteristics of rock anchors; R. Sage;
Cat. No. M38-13/77-56, ISBN 0-660-01806-3; Price: \$1.25 Canada, \$1.50 other countries.
- 77-58 Pit slope manual - Supplement 10-1 - Reclamation by vegetation - Vol. 2 - Mine waste inventory by satellite imagery; D. Murray;
Cat. No. M38-14/10-1977-1-2, ISBN 0-660-01464-5; Price: \$6.00 Canada, \$7.20 other countries.
- 77-60 The high-temperature behaviour of blast furnace coke - A review; D.A. Reeve, J.T. Price and J.F. Gransden;
Cat. No. M38-13/77-60, ISBN 0-660-01807-1; Price: \$1.25 Canada, \$1.50 other countries.
- 77-61 A rapid method for the determination of sulphur and vanadium in petroleum products by non-dispersive x-ray fluorescence; R. Makhija, R.G. Draper and E. Furnisky;
Cat. No. M38-13/77-61, ISBN 0-660-01848-9; Price: \$1.00 Canada, \$1.20 other countries.
- 77-65 Performance of superplasticizers in concrete: Laboratory investigation - Part 1; V.M. Mal'otra and D. Malanka;
Cat. No. M38-13/77-65, ISBN 0-660-01739-3; Price: \$1.75 Canada, \$2.10 other countries.
- 78-2 Revision of recommended values for reference ores MP-1 and KC-1; G.H. Faye and W.S. Bowman;
Cat. No. M38-13/78-2, ISBN 0-660-01712-1; Price: \$1.00 Canada, \$1.20 other countries.
- 78-3 Certified and provisional reference materials available from the Canada Centre for Mineral and Energy Technology, 1978; G. Faye;
Cat. No. M38-13/78-3, ISBN 0-660-01804-7; Price: \$1.25 Canada, \$1.50 other countries.
- 76-40F Evaluation des charbons marchands canadiens: Nouvelle-Ecosse et Nouveau Brunswick - 1975; T.E. Tibbetts et W.J. Montgomery;
Cat. No. M38-13/76-40F, ISBN 0-660-01821-7; Price: \$3.00 Canada, \$3.60 other countries.