

**PIT SLOPE MANUAL**

**supplement 5-2**

**ROTATIONAL SHEAR SLIDING:  
ANALYSES AND COMPUTER PROGRAMS**

This supplement has been prepared as part of the

PIT SLOPE PROJECT

of the

Mining Research Laboratories  
Canada Centre for Mineral and Energy Technology  
Energy, Mines and Resources Canada

MINERALS RESEARCH PROGRAM  
MINING RESEARCH LABORATORIES  
CANMET REPORT 77-17

**CANMET LIBRARY**

© Minister of Supply and Services Canada 1977

Available by mail from:

Printing and Publishing  
Supply and Services Canada,  
Ottawa, Canada K1A 0S9

CANMET  
Energy, Mines and Resources Canada,  
555 Booth St.  
Ottawa, Canada K1A 0G1

or through your bookseller.

Catalogue No. M38-14/5-1977-2 Price: Canada: \$3.00  
ISBN 0-660-01009-7 Other countries: \$3.60

Price subject to change without notice.

© Ministre des Approvisionnements et Services Canada 1977

En vente par la poste:

Imprimerie et Édition  
Approvisionnement et Services Canada,  
Ottawa, Canada K1A 0S9

CANMET  
Énergie, Mines et Ressources Canada,  
555, rue Booth  
Ottawa, Canada K1A 0G1

ou chez votre libraire.

N° de catalogue M38-14/5-1977-2 Prix: Canada: \$3.00  
ISBN 0-660-01009-7 Autres Pays: \$3.60

Prix sujet à changement sans avis préalable.

## THE PIT SLOPE MANUAL

The Pit Slope Manual consists of ten chapters, published separately. Most chapters have supplements, also published separately. The ten chapters are:

1. Summary
2. Structural Geology
3. Mechanical Properties
4. Groundwater
5. Design
6. Mechanical Support
7. Perimeter Blasting
8. Monitoring
9. Waste Embankments
10. Environmental Planning

The chapters and supplements can be obtained from the Publications Distribution Office, CANMET, Energy, Mines and Resources Canada, 555 Booth Street, Ottawa, Ontario, K1A 0G1, Canada.

Reference to this supplement should be quoted as follows:

Sage, R., Toews, N., Yu, Y. and Coates, D.F. Pit Slope Manual Supplement 5-2 - Rotational Shear Sliding: Analyses and Computer Programs; CANMET (Canada Centre for Mineral and Energy Technology, formerly Mines Branch, Energy, Mines and Resources Canada), CANMET REPORT 77-17; 92 p; May 1977.

## ABSTRACT

Instability by sliding on an approximately circular surface typically occurs in slopes in soft or ductile ground. The material must be sufficiently plastic to yield without excessive loss of strength. Soils, highly altered rocks such as soft hematites and limonites, waste rock and tailings usually behave in this way. An approximate analysis suitable for hand calculation is provided; for more detailed analysis a computer program, SLOPROB, is available and is described in Appendix A.

SLOPROB requires as input the distribution of stresses in the slope. This distribution is best obtained by a finite element analysis; a suitable program, SAP2D, is also available and is described in Appendix B.

In performing rotational shear analyses, the designer must also check for the possibility of block flow. This can arise if stress concentrations within the slope - which may be exaggerated by tectonic stresses - give rise to local breakdown of the slope material. This can lead to progressive breakdown of the surrounding rock and eventual instability. The finite element analysis can also be used to investigate stress distribution for block flow analysis.

## ACKNOWLEDGEMENTS

D.F. Coates was responsible for producing the Design chapter; address enquiries to him at: 555 Booth St., Ottawa, K1A 0G1, Canada.

R. Sage wrote the SLOPROB program and user manual with assistance from N. Toews, Y. Yu and A. Wong. N. Toews and Y. Yu prepared additions and modifications to the SAP program and wrote the user manual. SAP was written by Prof. E. Wilson et al, University of California (Berkeley).

The Pit Slope Manual is the result of five years research and development, cooperatively funded by the Canadian mining industry and the Federal Government of Canada. The project officers were successively D.F. Coates, M. Gyenge and R. Sage, who were assisted in managing the work by G. Herget, B. Hoare, G. Larocque, D. Murray and M. Service.

## CONTENTS

	Page
INTRODUCTION	1
Rotational sliding	1
Block flow	3
PROXIMATE ANALYSIS FOR ROTATIONAL SLIDING	5
Theory	5
Example	9
Earthquake forces	10
End effects and curvature	11
Variable slope angle	11
COMPUTER SOLUTION	13
REFERENCES	14
APPENDICES: A. User's manual for SLOPROB, a program analysing rotational sliding	15
B. User's manual for SAP2D, a finite element program	41

## FIGURES

1 Rotational sliding in homogeneous, yielding rock	2
2 Typical distribution functions for prospective rates of return	2
3 Principal stresses in a 60° slope model where the horizontal field stresses are one-third of the vertical stresses	4

	Page
4 Principal stresses in a 60° slope where the horizontal field stresses are three times the vertical stresses	4
5 A finite element model of a prospective open pit	6
6 Variation of toe stresses	6
7 Variation of critical slope angle	8
8 Variation of probability of instability with slope angle	8
9 A static analysis including earthquake effects	12
10 A pit plan showing concave and convex curvatures	12
11 Correction to slope angle to account for plan curvature	12

## INTRODUCTION

Rotational Sliding

1. Where it is judged that rotational sliding is possible, the stability of the wall can be analysed using either a proximate analysis based on an empirical equation or a detailed computer analysis based on a slip circle using stresses generated by a finite element program. Both analyses can be used to prepare schedules of probability of instability versus slope height for each trial slope angle. At least two feasible wall profiles must be examined for each sector, whether for the ultimate pit or for an interim pit bottom. Heights progressively increasing in 100 to 200 ft (30-60 m) intervals are analysed, and the results used to prepare probability schedules. The schedules are the main input data for the financial analysis of the Benefit-Cost program.

2. The proximate analysis can be used for walls of constant angle in uniform ground to obtain preliminary estimates of reliability. The computer analysis should be used when simplifying assumptions of the proximate analysis are to be avoided, such as when the profile geometry is complex or when the wall contains several geologic formations with different properties.

3. The common type of sliding in soft or ductile ground is by yielding and then rotation. When soils and rocks are sufficiently plastic to yield without excessive loss of strength at locations of high stress, stresses become more evenly distributed along the potential sliding surface. Because of this yielding, the shear strength of the ground is maintained, even though some zones have been overstressed. Clays, silts, sands and mixed-grained soils such as glacial tills usually behave this way. Highly altered rocks, such as soft hematites and limonites, highly brecciated zones, and waste rock and tailings behave similarly.

4. Slopes in such yielding materials usually slide with a segment describing rotational motion, as indicated in Fig 1(a). In ground where a substantial part of the strength is derived from internal friction, the curved shear surface will

pass through the toe. It is usual to assume that the surface is circular.

5. The total shear force causing sliding is assumed to be equal to or greater than the total shear strength along the surface of sliding. It is further assumed that the strength parameters in the ground are the same in all directions or inclinations.

6. The strength of the ground is based on Mohr's theory:

$$S_f = c + (\sigma - u) \tan \phi \quad \text{eq 1}$$

where  $S_f$  is the shear strength,  $c$  is the apparent cohesion in the ground,  $\sigma$  is the normal stress on the sliding surface,  $u$  is the pore water pressure on the sliding surface and  $\phi$  is the apparent residual angle of friction of the ground.

7. Information to establish that sliding would be by rotational shear is provided either by previous experience or by the structural geology investigations together with the testing program. The ground must be relatively isotropic (ie have uniform strength properties in all directions). The test results should indicate that the uniaxial compressive strength at strains greater than at maximum strength is greater than about 0.6 of the maximum strength. This value is based to some extent on results in shales and clay (1, 2). This degree of ductility will normally only occur for materials with a low uniaxial compressive strength. Until further research is conducted on this mechanism, assume that the strength must be less than about 75 psi (10,800 psf or 517kPa). Brittle materials, ie with lower ductility ratios, may produce slides in the rotational mode; however, they should be analyzed primarily for block flow instability. Indeed, even materials with ductility ratios of around 0.6 should be also examined for block flow instability.

8. For ground that is not isotropic, eg distinctly layered, a composite sliding surface can develop consisting of a plane section connecting to arcs at either end as shown in Fig 1(b). Comparative studies have shown that such surfaces can be quite accurately simulated by an arc that



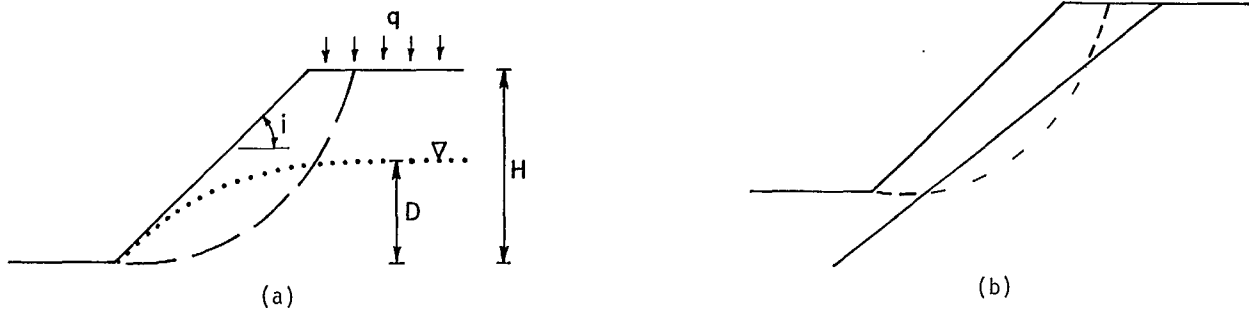

Fig 1 (a) Rotational sliding in homogeneous, yielding rock.  $i$  is the slope angle.  $D$  is the height of the groundwater table above the toe of the slope.  $H$  is the height of the slope.  $q$  is a surcharge pressure on the ground surface at the crest of the slope, eg a waste dump. (b) A composite sliding surface approximated by a circular surface.

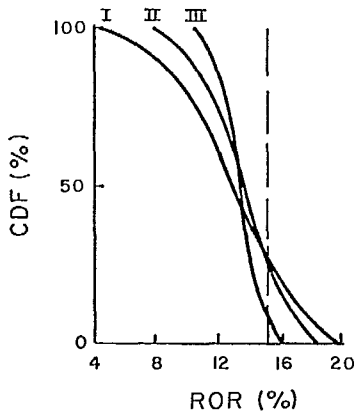

Fig. 2 Typical probability or cumulative distribution functions, CDF, for prospective rates of return, ROR, on a mine investment. The uncertainty or dispersion of the estimates decreases from I, the feasibility stage, to II, the mine design stage, to III, the operating stage, reflecting the improvement in the quality of the estimates of the costs and revenues. The y-axis indicates the estimated probability that the ROR will be more than the x-value (4).

fits approximately the actual slide surface(3). To analyse such cases, knowledge of the shear strength of each material comprising the composite slide surface is required.

9. Pore water pressures within a slope decrease stability. Groundwater investigations provide information on the mean annual maximum water level in the ground behind the slope together with the fluctuations that can be expected. Cracks and joints in the rock can become filled with runoff water producing hydrostatic heads that are greater than the general groundwater level. Seepage pore pressures result in a reduction in frictional resistance.

10. In compressible materials, such as clays, the deformation and expansion of the ground resulting from excavation and sometimes evaporation can cause negative pore pressures that provide a temporary stabilizing effect. Such ground is not likely to be encountered in the walls of open pits in Canada; consequently, the mechanics of such reactions are not treated in this manual.

11. For a slope such as is shown in Fig 1, the force tending to resist sliding,  $R$ , is the shear resistance on the sliding surface. The forces tending to promote sliding are equivalent to  $F$ , the shear force on the sliding surface.  $R$  and  $F$  have different values at each point in a slope. These values cannot be precisely determined and must be regarded for design purposes as random variables whose values can be estimated to have a certain distribution within a given range. The reliability of the slope is defined as the probability  $[R > F]$ ; the probability of instability  $P_f = \text{probability } [R < F]$ .

12. This statement can be interpreted to mean: if  $N$  similar slopes, or  $N$  cells in one slope, exist then the number of slopes or cells that actually slide approaches  $N \cdot P_f$  as  $N$  becomes large. For a long pit wall, a cell is defined as having a width parallel to the wall equal to the height. The number of cells,  $N$ , in the wall equals  $L/H$  where  $L$  is the length of the wall and  $H$  is the height.  $P_f$  can also be an appraisal of the "likelihood of sliding" for any slope.

13. The confidence that can be placed in the

calculated probabilities is dependent on the quality of the sampling, testing, field observations and other statistical data (such as groundwater levels, precipitation measurements and perhaps earthquake frequencies). It is also affected by the veracity of the analysis. During the feasibility and mine design stages, the distributions and means of the various parameters are likely to be known only approximately. During operations, on the basis of experience and observations in the pit higher quality data can be produced. Fig 2 shows the effects of this type of evolution on the appraisal of prospective rates of return due to the quality of the financial parameters having improved with experience.

#### Block Flow

14. In some pit walls instability, if it occurs must be due to the breakdown of the rock substance. In this case, structural conditions do not favour plane shear sliding, and the rock substance is not sufficiently ductile to permit rotational sliding. Consequently, crushing of the rock at points of highest stress will occur. After such local crushing, load is transferred to adjacent zones, which in turn are subjected to excessive stress leading to further crushing. This progressive action, which can be observed in the working and deforming of some slopes before major movement, continues until a general breakdown of the rock mass occurs with a flow of broken rock.

15. Zones of maximum stress in the slope can arise from various causes. In a homogeneous formation, the stress trajectories could be expected to be substantially as shown by the models in Fig 3 and 4. The deflection of the stress around the toe of the slope results in a concentration in this area similar to the notch effect in structural members. This stress concentration may result in crushing leading to instability.

16. It can be seen that the notch effect is slight where field stresses are just due to gravity, ie when horizontal stresses are a fraction of the vertical stresses. On the other hand, with larger horizontal stresses, due to

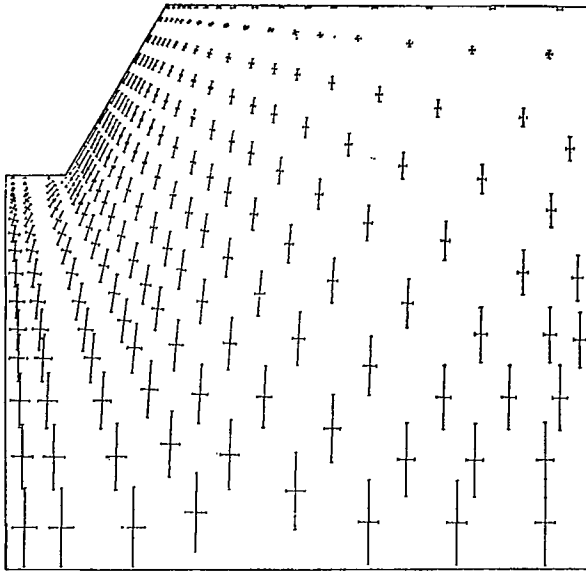

Fig 3 Principal stresses in a 60° slope finite element model where the horizontal field stresses are one-third of the vertical stresses; the long bars of the crosses represent the magnitude and direction of the maximum compressive stress; the short bar represents the minimum compressive stress. Note how the maximum stresses flow parallel to the slope face and then around the toe.

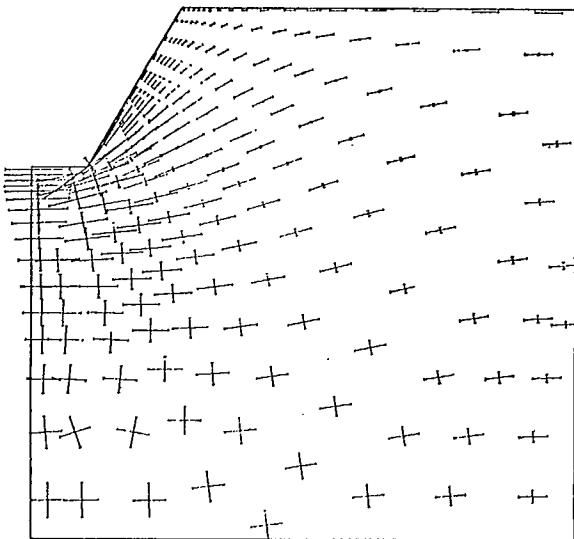

Fig 4 Principal stresses in a model of a 60° slope where the horizontal field stresses are three times the vertical stresses. Note the crowding of the flow of stress around the toe, producing more stress per unit area, or a concentration of stress.

tectonic action, the notch effect is more significant.

17. The models used to determine the stress distributions described above were elastic and homogeneous (5). These assumptions are not usually valid for real slopes. However, the stress flow in real slopes must have some similarity to these idealized patterns. The differences are analogous to the differences in the flow of water in a rocky stream compared to that in a regular, smooth channel in a laboratory.

18. Stress concentrations in slopes also occur where rocks of differing stiffnesses exist in a slope. In one case, a thin strong layer of quartzite occurs in the footwall of a series of predominantly schistose rocks. The quartzite layer is much stiffer than the adjacent layers. Excavation of the open pit will cause stress concentrations something like that shown in Fig 5. The quartzite will be subjected to stresses approximately five times those in the adjacent schist layers. Because the strength of the quartzite is only about twice that of the schist, crushing would occur first in the quartzite. For a high enough slope, instability thus could be initiated in the quartzite layer and spread progressively to adjacent rocks creating a slide in the wall.

19. To determine toe stresses and other zones of concentration of stress, the finite element method is available. This method must be used because no theoretical solution exists for this problem. The results are, at best, rough estimates in most cases of actual stresses. Appendix B provides a finite element program that can be used. Other programs and previous work leading to general graphs such as shown in Fig 6 are available (5).

20. To simulate pit walls, modeling can include to some extent the variation in deformation properties of the different formations and also the deformation properties of some of the discontinuities that have been identified in the field investigation. Homogeneous field stress conditions of tectonic origin can also be included. Where appropriate, the effects of ground water flow into the pit can be included in the

analysis although the associated hydraulic pressures would not normally influence the breakdown of the blocks of rock.

21. When block flow is considered to be the only potential mode of sliding, it will be desired to produce schedules of variation of reliability with slope height for selected slope angles. At the present time and for the foreseeable future, the most difficult problem in such an analysis is to determine the magnitude of horizontal field stresses to be used for the determination of the critical stresses. In many cases, the best that can be done is, after a geological appraisal of the site, to make an estimate of  $K$  (the ratio of horizontal to vertical field stresses). Under these circumstances, a relatively simple probability analysis is appropriate, and although the results will be crude the procedure makes best use of all the information that can be obtained to provide a basis for judgment in establishing the ultimate pit design. The procedure can also highlight areas where further expenditure of funds is warranted to obtain critical information. Recognizing the approximate nature of the information that is likely to be available on the horizontal field stresses and the large dispersions that have been shown commonly to occur by several studies at mine sites in Canada, it must be concluded that block flow analyses will only be of practical value for particularly high, extensive slopes. Furthermore, it lacks scientific confirmation that the above approach is a good representation of reality; hence no detailed procedures are being recommended at this time.

#### PROXIMATE ANALYSIS FOR ROTATIONAL SLIDING

##### Theory

22. A slope will have some critical angle  $i_c$  at which sliding will just occur. Slopes steeper than  $i_c$  will slide, slopes less steep will not. The angle  $i_c$  depends on stresses and strengths within the slope; since these cannot be precisely determined neither can  $i_c$ . If  $i$  is the actual slope angle, then  $P_f$ , the probability of sliding, is the probability that  $i$  is greater than  $i_c$ :

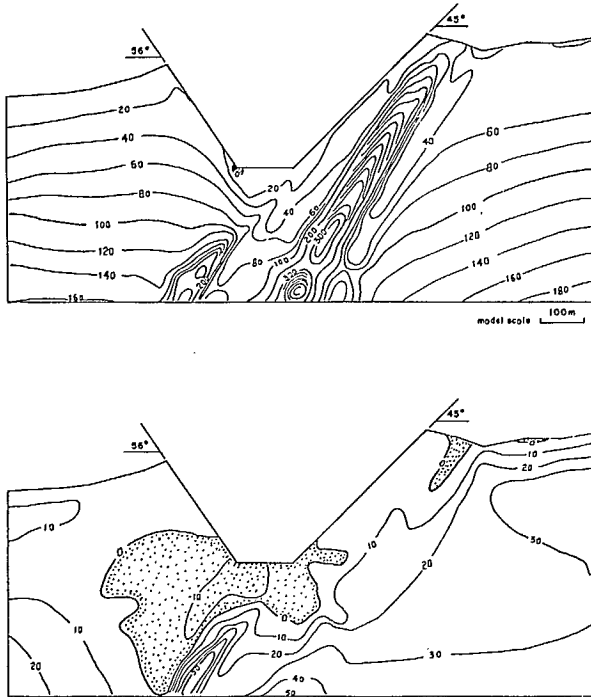

Fig 5 A finite element model of a prospective open pit. The footwall, on the right, consists mainly of schistose layers but also contains a layer of hard quartzite that is much stiffer than the other layers. As the pit is excavated the stiff quartzite can be expected to take more than its share of the load from the slope. The contours of equal maximum compressive stress show the concentration of stress in the quartzite to be some five times that in the adjacent layers.

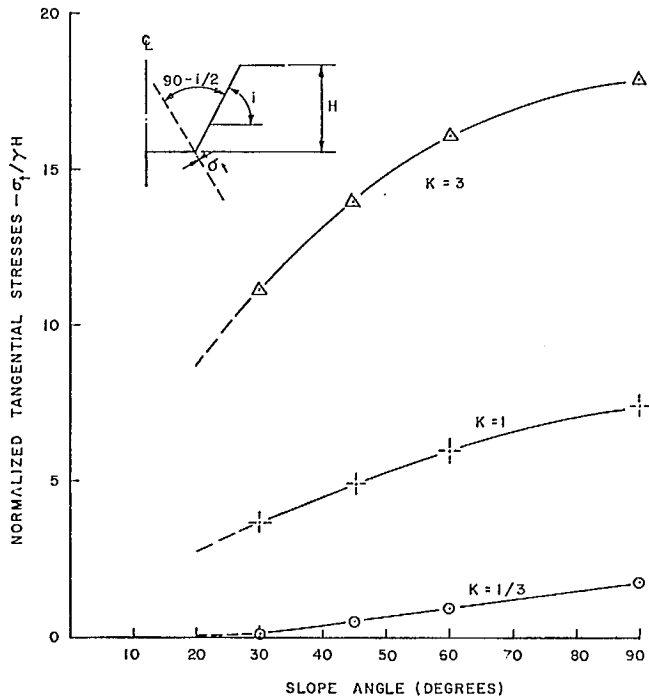

Fig 6 Variation of toe stresses,  $\sigma_t$ , with slope angle and  $K$  (the ratio of horizontal to vertical field stress) under plane strain conditions. ( $\gamma$  is the density of the rock mass in the wall;  $H$  is the height of the slope;  $\sigma_t$  is at a point approximately 2m in from the rock surface.)

$$P_f = P[i > i_c]. \quad \text{eq 2}$$

The angle  $i_c$  can be calculated using an empirical equation based on approximation curves such as is shown in Fig 7 (6). The following equation gives the approximate critical slope angle,  $i_c$ , for homogeneous, isotropic ground, without tension cracks but with groundwater being drawn down by the excavation (see Fig 1).

$$i_c = \frac{445c}{(\gamma H + q)} + \phi(1.2 - 0.3 \frac{D}{H}) - 7 \quad \text{eq 3}$$

where  $c$  is the apparent cohesion,  $\gamma$  is the rock mass unit weight,  $H$  is the slope height,  $q$  is the surcharge pressure on the ground at the slope crest (eg due to a waste dump),  $\phi$  is the apparent residual angle of internal friction in degrees, and  $D$  is the maximum annual height of the water table around the pit at a distance behind the crest unaffected by the drawdown of the excavation.

23. The critical angle  $i_c$  is a function of the independent variables  $c$ ,  $\gamma$ ,  $H$ ,  $q$ ,  $\phi$ , and  $D$ . These may be regarded as random variables within certain ranges. (Actually, some physical correlation could exist between  $c$ ,  $\phi$  and  $H$ , and between  $H$  and  $D$ ; however, these correlations would require an extensive research program to establish, and for the proximate analysis assuming no correlation is appropriate.) The variation of each is assumed to follow a normal distribution.

24. Rotational sliding includes yielding at points where stress exceeds strength. For this reason, the method is based on comparing total shear force with total shear resistance. Even with shear strength parameters being subject to variation between elements of ground making up the slip surface, because it is their summation that is relevant and the number of elements is large, average parameters can be used to calculate the total resistance.

25. It can be envisaged for a long pit wall in one rock formation that the resistance to sliding at one cell will be different from that at another cell, which is equivalent to saying that the averages of a shear strength parameter will have a

dispersion between sections. A measure of this dispersion is the standard deviation of the means,  $SS$ , which has been established as being equal to:

$$SS = \left( \frac{1}{n^2} \sum_1^n (x_i - M)^2 \right)^{\frac{1}{2}}$$

$$= \sqrt{(v/n)} = S/\sqrt{n}$$

where  $v$  is the variance of all the test results for the parameter,  $S$  is their standard deviation and  $n$  is the number of samples. Where a large number of samples are tested,  $SS$  becomes very small. Hence the dispersion of average values becomes small so that the probabilistic aspect is diminished.

26. Future research or examination of test data may show that some of the variations should follow non-normal distributions. However, the magnitude of the probabilities involved in wall design means that normal distributions are usually good enough approximations for the parameters of eq 3. It has been shown that, unless the probabilities of interest are less than about 0.001, most deviations from normal distribution are insignificant for practical purposes (7). If the quality of the input data for the analyses is low, the confidence that can be placed in the results is, of course, also low, which is comparable to the use of poor quality financial data when none other is available. At the same time, a problem does exist arising from using normal distribution curves for  $c$  and  $\phi$ , which can extend beyond the origin indicating negative values. The distributions should be truncated at zero or some greater, threshold values. Unless this is done erroneously low reliabilities will be calculated for low slope angles.

27.  $P_f$  can be evaluated if  $M_i$ , the mean value of  $i_c$  and  $S_i$ , the standard deviation of  $i_c$ , are known.  $M_i$  can be found by substituting the mean values of  $c$ ,  $\gamma$ ,  $H$ ,  $q$ ,  $\phi$  and  $D$  into eq 3 because they are assumed to be independent.  $S_i$  can be found using the following equations for calculating the standard deviation of the resultant of two independent random variables. It is assumed that the resultants are normally

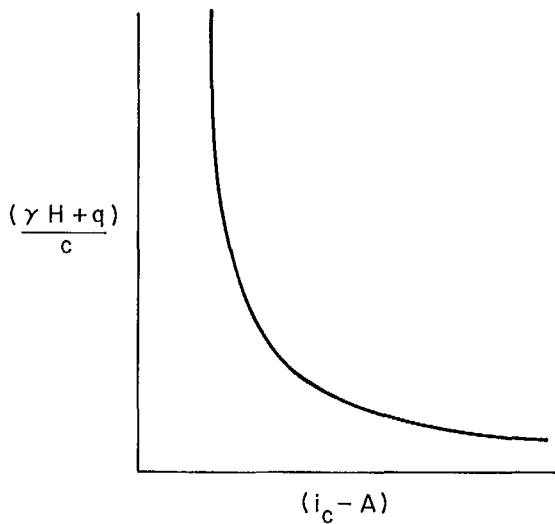

Fig 7 Variation of critical slope angle,  $i_c$ , with height of slope,  $H$ , density of rock,  $\gamma$ , surcharge pressure on the ground surface,  $q$ , and cohesion of the rock,  $c$  ( $A$  is a function of the angle of friction in the rock,  $\phi$ , the height of the water table,  $D$ , and  $H$ ) (6).

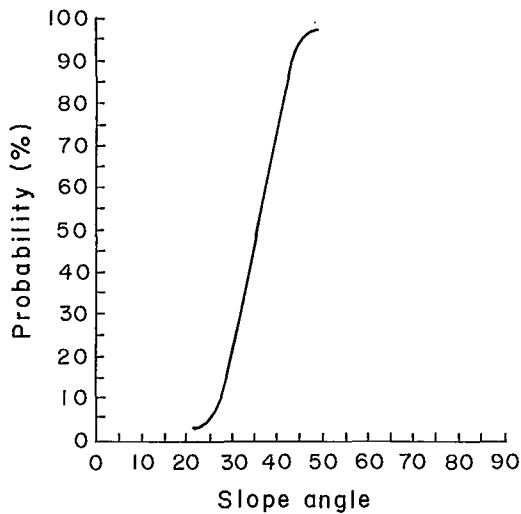

Fig 8 Variation of probability of instability with slope angle for the following parameter means and standard deviations:  $H = 235$  ft, 10 ft (72m, 3m);  $D = 220,0$  ft (67,0m);  $\phi = 33,2^\circ$ ;  $c = 1000,500$  psf (48,23 kN/m<sup>2</sup>).

distributed, which is quite reasonable for the proximate analysis. Using the computer solution would provide a more accurate distribution. From Appendix A of the chapter, standard deviations can be computed as follows.  $S$  for  $(x+y)$  and  $(x-y)$  is given by

$$S = (S_x^2 + S_y^2)^{\frac{1}{2}} \quad \text{eq 4}$$

The standard deviation of  $(xy)$  is given by

$$S = (M_x^2 S_y^2 + M_y^2 S_x^2 + S_x^2 S_y^2)^{\frac{1}{2}} \quad \text{eq 5}$$

The standard deviation of  $(x/y)$  is given by

$$S = \frac{1}{M_y^2} [M_x^2 S_y^2 + M_y^2 S_x^2]^{\frac{1}{2}} \quad \text{eq 6}$$

Knowing  $i$ ,  $S_i$  and  $M_i$ ,  $P_f$  can be found either from the tables of normal distributions or from the graph of reliability,  $R = (1 - P_f)$ , versus  $(i - M_i)/S_i$  (see Appendix A Table A-3 or Fig A-6 of the main volume of the Design chapter). Alternatively, the following equation can be used:

for the range  $(M_i - 2S_i) < i < (M_i + 2S_i)$

$$P_f = 0.45 \sin \left[ \left( M_i \left( \frac{S_i}{45} - 1 \right) + i \right) \frac{45}{S_i} - M_i \right] + 0.5 \quad \text{eq 7}$$

This equation has no basis in theory; it simply provides an ogive curve that passes through the points representing the mean value of the slope angle and the values that are two standard deviations above and below the mean. For  $i < (M_i - 2S_i)$   $P_f$  is less than 5%; for  $i > (M_i + 2S_i)$   $P_f$  is greater than 95%. Fig 8 shows such a curve produced by programming eq 3 on an office calculator equipped with a plotter (8).

28. Design parameters for eq 3 are obtained from the site investigation. Strengths are obtained either from case histories or as described in the chapter on Mechanical Properties. Where testing is required, the number of boreholes, samples and tests must be specified for the proper representation of a formation. Strength parameters,  $c$  and  $\phi$ , are obtained from consolidated drained (CD) triaxial tests on undisturbed samples. Residual values are used in

the analysis, and the reaction after the peak strength is exceeded is checked to ensure that the material will provide the appropriate plastic reaction. As explained above, for the strength parameters,  $c$  and  $\phi$ , mean values of the test results and standard deviations of the means,  $SS$ , are the values to be used in eq 3 to 6. The density,  $\gamma$ , is that of the formation, which requires either field density tests or the weighing of excavated material together with careful measuring to determine in-place volumes. The maximum annual height of the water table,  $D$ , is obtained as described in the chapter on Groundwater. In all cases, mean values together with standard deviations are required to represent operating conditions.

#### Example

29. A pit wall in highly altered rock is to have a height,  $H$ , of 500 ft (152.3 m) with variations in topography causing a standard deviation of the height of 20 ft (6.1 m). The average density of the rock mass,  $\gamma$ , is 173 pcf (2771 kg/m<sup>3</sup>) with a standard deviation of 9 pcf (144 kg/m<sup>3</sup>). The average annual maximum height of groundwater above the ultimate toe of the wall,  $D$ , is 400 ft (121.8 m) with a standard deviation of 50 ft (15.2 m). There will be no surcharge on the ground surface at the crest, ie  $q = 0$ . The wall rock strength parameters are as follows: mean  $c = 10$  psi (69kPa) with a standard deviation of the means of 3 psi (20.7kPa) and mean  $\phi = 35^\circ$  with a standard deviation of the means of  $5^\circ$ .

30. From eq 3, the critical slope angle,  $M_i$ , for the mean values of the above parameters is determined as follows:

$$M_i = 445(10 \times 144)/(173 \times 500) + 35(1.2 - 0.3 \times 400/500) - 7 = 34^\circ$$

Being based on mean values, a slope 500 ft high at  $34^\circ$  would have a 50% probability of sliding.

31. To determine the standard deviation of the critical slope angle, the following calculations are made using eq 4, 5 and 6 (throughout the following,  $M$  is the mean and  $S$  is the standard



deviation):

$$\begin{aligned} \text{for } \gamma H: \quad M &= 173 \times 500 = 86,500 \\ \text{eq 5: } S &= (173^2 \times 20^2 + 500^2 \times 9^2 + 9^2 \times 20^2)^{\frac{1}{2}} \\ &= 5679 \end{aligned}$$

$$\text{for } c/\gamma H: \quad M = 10 \times 144 / 86,500 = 0.01665$$

$$\begin{aligned} \text{eq 6: } S &= \frac{1}{86,500^2} [(10 \times 144)^2 \times 5679^2 + 86500^2 (3 \times 144)^2]^{\frac{1}{2}} \\ &= 0.00511 \end{aligned}$$

$$\begin{aligned} \text{for } (445 c/\gamma H): \quad M &= 445 \times 0.01665 = 7.409 \\ S &= 445 \times 0.00511 = 2.274 \end{aligned}$$

$$\begin{aligned} \text{for } D/H: \quad M &= 400/500 = 0.8 \\ S &= \frac{1}{500^2} \{400^2 \times 20^2 + 500^2 \times 50^2\}^{\frac{1}{2}} = 0.1050 \end{aligned}$$

$$\begin{aligned} \text{for } (0.3 D/H): \quad M &= 0.3 \times 0.8 = 0.24 \\ S &= 0.3 \times 0.1050 = 0.0315 \end{aligned}$$

$$\begin{aligned} \text{for } (1.2 - 0.3 D/H): \\ M &= 1.2 - 0.24 = 0.96 \\ S &= 0.0315 \end{aligned}$$

$$\begin{aligned} \text{for } \phi (1.2 - 0.3 D/H): \\ M &= 35 \times 0.96 = 33.6 \\ S &= (35^2 \times 0.0315^2 + 0.96^2 \times 5^2 + 5^2 \times 0.0315^2)^{\frac{1}{2}} \\ &= 4.928 \end{aligned}$$

$$\begin{aligned} \text{for } i: \quad M_i &= 7.4 + 33.6 - 7 = 34^\circ \\ S_i &= (2.274^2 + 4.928^2)^{\frac{1}{2}} = 5.4^\circ \end{aligned}$$

Clearly, the standard deviation of the friction angle,  $5^\circ$ , has the dominant influence in this example. The number of samples tested to determine strength could be used to calculate confidence limits for the results; however, this would not be meaningful for the proximate analysis, which provides only a first approximation.

32. A trial angle of  $30^\circ$  is examined for the above wall. The normalized safety margin  $(M_i - i)/S_i$  is  $(34 - 30)/5.4 = 0.74$ . From Table A-3 in Appendix A of the chapter for  $z = 0.74$ , interpolating between 0.2419 and 0.2118, the corresponding probability of instability is 23.0%.

33. Where the height of the wall is less than 500 ft, the same type of calculation gives the following schedule:

	H	$P_f$
	100 ft (30 m)	0%
for $\gamma H$ :	200 ft (61 m)	1.4%
eq 5:	300 ft (91 m)	6.5%
	400 ft (122 m)	13.6%
for $c/\gamma H$ :	500 ft (152 m)	23.0%

This is the form required by the Benefit-Cost program to perform the financial analysis on the results of a set of stability analyses for two or more trial design slope angles, eg  $28^\circ$ ,  $30^\circ$  and  $33^\circ$ .

#### Earthquake Forces

34. The effect of earthquakes on the stability of pit slopes is often questioned. Soil slopes have failed under earthquake loading, eg those at Anchorage, Alaska, in 1964. No cases have been recorded of pit walls failing due to earthquake forces, although there are indications that earthquakes may have combined with the existing forces to turn some cases of incipient instability into slides. A rigorous analysis of the effects on a slope of an assumed earthquake ground motion is still in the realm of research. A simple approach is to apply a horizontal force commensurate with a representative horizontal ground acceleration.

35. The effect of horizontal acceleration due to earthquake is to produce, as shown in Fig 9, a horizontal force equal to  $Wa$  (where  $W$  is the mass of the sliding segment and  $a$  is the horizontal acceleration of the ground due to the earthquake). This force is added to that of the gravitational force,  $Wg$  (where  $g$  is the acceleration due to gravity). The combination of these forces then produces a resultant force on the failure segment that is inclined to the vertical at an angle of  $(\tan^{-1} a/g)$ . If it is considered that the risk of an earthquake is sufficiently important and if a peak acceleration  $a$  can be predicted, then the mean critical slope angle,  $M_i$ , can be decreased by the angle  $(\tan^{-1} a/g)$ . The determination of  $P_f$  then proceeds as usual.

36. For example, in the calculation above, if

$a = 0.05g$  then  $\tan^{-1} a/g = 2.9^\circ$ . In this case  $M_1 = 34.0 - 2.9 = 31.1^\circ$ ;  $S_1$ , the standard deviation, is assumed to remain the same unless a more refined analysis requires the inclusion of the stochastic aspects of earthquake frequency.

#### End Effects and Curvature

37. Analyses in this supplement are two-dimensional, ie resistance of the ends of the sliding segment is ignored. This is normally a conservative design procedure. However, if the strength parameters are obtained by analysing previous slides, ignoring the end effects may result in calculated strengths that are higher than those that are valid for the actual ground. Where slide segments are quite narrow in plan, the contribution of the ends is a significant proportion of the total shear resistance. On the other hand, if the segment is quite long, the contribution of the ends is relatively insignificant.

38. Curvature in plan of a pit wall can affect the shear resistance of the ends of the sliding segment as a result of horizontal arching that comes into play for concave walls and tensile separation adjacent to noses or convex walls (Fig 10).

39. The following equations, based on field studies and numerical modelling, can be used to correct  $M_1$ , the mean critical slope angle (9, 10). In the case of concave horizontal curvature such as shown in Fig 6 and for  $r$  greater than 0.5:

$$I = 3/(2r - 3) \quad \text{eq 8}$$

where  $I$  is the increment to be added to  $M_1$  and  $r$  is the horizontal radius of curvature to the crest as a ratio of the height of the slope (Fig 11). Although no quantitative empirical data exists on the effects of convex curvature, models indicate that it would be reasonable to use the same equation for negative corrections to  $M_1$ .

40. In the previous example, if the horizontal radius of concave curvature is 500 ft (152.3 m),  $r$  will be  $500/500 = 1$ , and  $I = 3/(2 \times 1 - 1) = 3.0^\circ$ .

Hence  $M_1 = 34^\circ + 3^\circ = 37^\circ$ . It is assumed that the standard deviation of the critical slope angle remains the same; consequently the probabilities are calculated as before.

#### Variable Slope Angle

41. A variable slope angle is sometimes desirable, either because of varying rock properties in the slope or because waste excavation might be reduced. A theoretical study of the effects of using a variable slope angle to minimize waste excavation for a tabular orebody showed the analysis to be complex (5). The critical slope angle was based on the shear stress acting at the toe of the slope, which may not be a completely satisfactory criterion but for slides by rotational shear and block flow is quite relevant. Both concave (or bathtub) and convex (or humpback) shaped slopes were examined. The models indicated that under certain conditions waste excavation might be reduced by 20% using a concave-shaped slope. These theoretical results were found to be dependent on the pre-mining stress conditions. As a result of this study, it seems possible that actual costs in some cases could be reduced by using variable slopes.

42. An estimate of the probability of instability for a slope with a variable angle or with different rock properties can be obtained using the proximate analysis. In this case, average rock properties and an average slope angle must be used. A detailed analysis requires the use of the computer program, SLOPROB.

43. Preparation of schedules of probability of sliding versus slope angle for the case of a variable slope angle requires definition of the slope. The slope might be characterized by the angle from crest to toe (as recommended in the chapter for convex slopes), by the average of two slope angles for a bi-linear slope, by parabolic constants for a continuously variable slope, or by some other similar procedure that is suitable for the particular case.

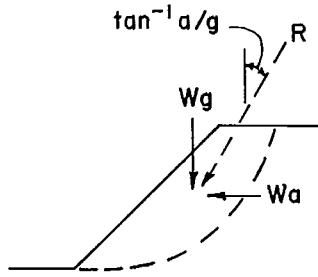

Fig 9 A static analysis showing how the effects of an earthquake are equivalent to increasing the slope angle by an amount equal to  $\tan^{-1}a/g$ .

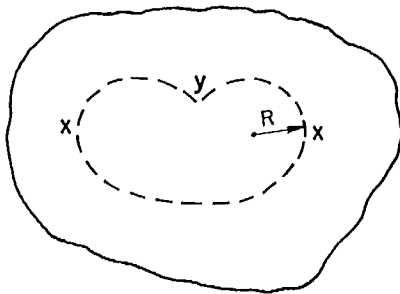

Fig 10 A pit plan showing concave (x) and convex (y) curvatures. R is the radius of curvature.

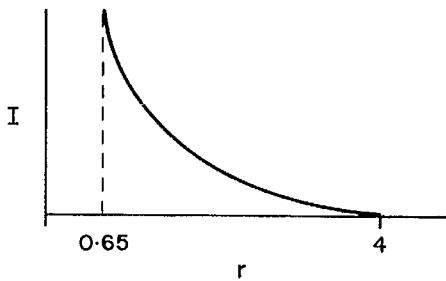

Fig 11 Variation of correction angle,  $I$ , with the ratio,  $r$ , of horizontal radius of curvature at the crest to slope height to account for the increased stability of concave plans and the decreased stability of convex plans.

## COMPUTER SOLUTION

44. A user's manual for the computer analysis, SLOPROB, is presented in Appendix A. The user's manual gives a description of the solution procedure, including the development of the necessary probability theory, a description of the program options and data requirements, a listing of the program, and an example with input and output data. Part of the input data required by SLOPROB is obtained from finite element stress analysis of the slope. The user's manual for the computer program for the finite element analysis, SAP2D, is given in Appendix B.

45. SLOPROB is based on slip-circle analyses but uses stresses determined by a finite element analysis, which are summed to give a total shear force. Strength parameters are provided for each finite element, and resistances are computed. The program can deal with any slope geometry and any number of formations with different strength properties. The critical, or most unstable, circle for sliding and the corresponding probability of instability are then determined. Mean values and standard deviations of the different rock properties are input.

46. Slopes are analysed in the conventional two-dimensional cross-section, and surfaces of sliding are assumed to be circular. Trial slip circles are specified by circle centres and either one point on the circle or a common tangent to the circles. The circle centres are given by the intersection points of a rectangular grid. If the circles are specified by a centre and one point, the point may be anywhere; usually, however, the point will be on the slope, the toe being commonly chosen. Similarly, any line may be specified as the common tangent.

47. The normal stresses and the shear stress are regarded as deterministic, ie not subject to random variation. On the other hand, variability is recognized in cohesion, pore pressure, and

friction angle. The means and standard deviations for the strength properties and groundwater level must be determined by site investigations.

48. Pore pressures are determined from the phreatic surface. Based on the investigations and analyses described in the chapter on groundwater, two limiting phreatic surfaces, a maximum and a minimum, are defined by straight line segments approximating a smooth curve. The variation around the mean of this surface is assumed to follow a uniform, instead of a normal distribution. The differences in results using a truncated normal distribution, a triangular distribution and the the uniform distribution were found to be small. The pore pressure at a point on the slip surface is taken as the head equal to the vertical distance below the phreatic surface.

49. Each slip circle is divided into a number of equal chords, the number being specified by the user. For each chord the shear force, the mean resistance and the standard deviation of the resistance are determined in the program. The probability that the resistance along the whole slip surface is less than the shear force is the probability of sliding. The conventional factor of safety, as well as the probability of sliding, is determined for each trial circle.

50. The critical circle, ie the circle with the highest probability of sliding, is selected from all the trial circles. SLOPROB is usually run at least twice, once with a coarse mesh of circle centres and a second time with a finer mesh in a restricted region, which is selected after inspection of the results of the first run.

51. Several options are included in the program. Up to 10 different materials may be used in the slope cross-section (ie 10 materials with markedly different strength parameters). A tension crack may be included. Any sign convention for stresses and any consistent system of units may be used. There is no restriction on slope geometry.

## REFERENCES

1. Bjerrum, L. "Progressive failure in slopes of overconsolidated plastic clay and clay-shales"; Proc ASCE; v. 93, no. SM5, Part 1, pp 1-50; 1967.
2. Yuceman, M.S. et al "A probabilistic study of safety and design of earth slopes"; Structural Res Series no. 402; U of Illinois; 1973.
3. Hamel, J.V. "Stability of slopes in soft, altered rocks"; PhD Thesis; U of Pittsburgh; 1970.
4. O'Brien, D.T. "Financial analysis; A tool for the progressive mining man"; Min Eng v. 21, no. 10, pp 67-71; 1969.
5. Yu, Y. and Coates, D.F. "Analysis of rock slopes using the finite element method"; CANMET Research Report R229; Info Can; 1970.
6. Hoek, E. "Estimating the stability of excavated slopes in opencast mines"; Trans IMM v. 9; pA109-A132; 1970; v. 10, pA72-A83; 1971.
7. Ang, A. "Probabilistic bases of safety; Performance and design"; ASCE Specialty Conf on Safety & Reliability of Metal Structures; 1972.
8. Call, R. personal communication.
9. Piteau, D. and Jennings, J. "The effects of plan geometry on the stability of natural slopes in rocks in the Kimberley area of South Africa"; Proc 2nd Cong Int Soc Rk Mech; Belgrade; v. 3; pp 289-295; 1970.
10. Lorente de No C. "Stability of slopes with curvature in plane view"; Proc 7 Int Conf Soil Mech & Fdn Eng; v. 2, pp 635-638; 1969.

APPENDIX A

USER'S MANUAL FOR SLOPROB,

A PROGRAM ANALYSING ROTATIONAL SLIDING

## PROGRAM IDENTIFICATION

Program Title

Probability of Slope Instability by Rotational Shear

Program Name

SLOPROB

Author

Roy Sage

Organization

Mining Research Laboratories, CANMET, Department of Energy, Mines and Resources, 555 Booth Street, Ottawa, K1A 0G1, Canada.

Date of First Documentation

June 1974

Source Language

Fortran V (level 3 on the CDC 6400 computer)

Availability

Card Decks and listings will be supplied at cost on request to the Mining Research Laboratories

Disclaimer

Neither the author nor the Mining Research Laboratories can accept responsibility for the correctness of the results obtained from this computer program.

## APPLICATION OF SLOPROB

Introduction

1. SLOPROB performs two-dimensional slip circle stability analyses of a slope, using the results of a prior finite-element analysis. The slope can be of any geometry of the general type shown in Fig A-1. The slope may contain up to 10 different materials and have a variable profile. A range of slip circles defined by the user is analysed in each run, and the critical circle, ie the circle with the highest probability of sliding, is determined. Studies have shown that SLOPROB, when used in a conventional analysis, gives the same safety factors as traditional programs.

2. The probability of sliding is defined as  $P_f = P[R < F]$  where R is the total shear resistance on the slip circle and F is the shear force on the slip circle. The shear resistance is evaluated by the Mohr's strength theory, eq 1. The disturbing shear force is obtained by summing the shear forces, on the finite elements adjacent to the sliding surface.

3. The circle with the least excess shear strength, ie the lowest value of (R-F), and the circle with the lowest conventional factor of safety are also determined. The factor of safety, FS, is defined as:

$$FS = \frac{\text{total shear resistance on slip circle}}{\text{total shear force on slip circle}}$$

The lowest excess shear resistance and the conventional factor of safety are determined using mean values of c,  $\phi$  and u.

4. In the determination of the probability of sliding, c,  $\phi$  and u are regarded as random variables; c and  $\phi$  because they cannot be precisely determined and u because it fluctuates with time and also cannot be precisely determined. The normal and shear stresses on the sliding surface,  $\sigma$  and  $\tau$ , are regarded as deterministic.

5. Each case requires a finite element analysis of the slope (see Appendix B). The stresses and centre coordinates for each element obtained from this analysis are input to SLOPROB,

as well as the simplified slope geometry (ie crest and toe coordinates), the strength parameters for each material in the slope, the coordinates defining the rectangular region of each material, and the pore water parameters.

6. The range of slip circles appropriate for the particular slope is specified by the user. As shown in Fig A-2, the user specifies a grid for circle centers and either a point through which all circles pass or a line that all circles touch. Usually the grid covers an area around a point beyond the toe of the slope and above the crest. The specified point may lie on the boundary of the slope, such as the toe of homogeneous ground, in which case it will coincide with the entry point or exit point as defined in Fig A-2. The user may give a range of specified points to be considered in turn by the program. A tension crack can be included in the analysis.

Theory

7. The circular arc surface is divided into n small chords. The shear and normal stresses on the  $i^{\text{th}}$  chord are  $\tau_i$  and  $\sigma_i$ ; the disturbing shear force is given by

$$F = \sum_{i=1}^n \ell_i \cdot \tau_i$$

where  $\ell_i$  is the length of the  $i^{\text{th}}$  chord. The resisting force R is given by

$$R = \sum_{i=1}^n \ell_i (c_i + (\sigma_i - u_i) \tan \phi_i)$$

where  $u_i$  is the pore water pressure on the  $i^{\text{th}}$  chord, and  $c_i$ , and  $\phi_i$  are the cohesion and friction angle at this chord.

8. The stresses,  $\sigma_i$  and  $\tau_i$ , from the finite element analysis, depend largely on the weight and geometry of the slope above the slide surface. They are subject to variation due to inaccuracies from measuring the rock densities and geometry of the slope, from varying deformation properties and from inaccuracies in the finite element method. However, this variation in  $\sigma_i$  and  $\tau_i$  will usually be much smaller than the variations in  $c_i$ ,  $\phi_i$  and  $u_i$ . It is, therefore, assumed that  $\sigma_i$  and  $\tau_i$  can



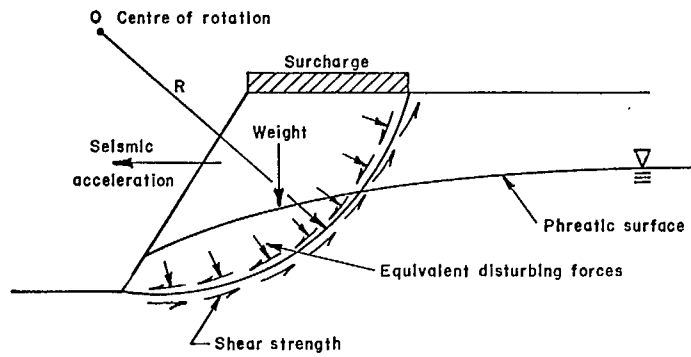

Fig A-1 Schematic view of rotational sliding for reference in the computer program.

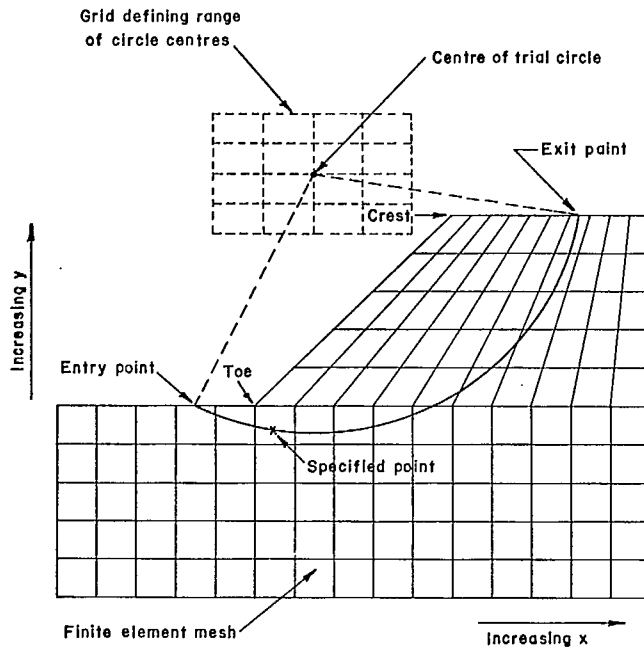

Fig A-2 Definition of slip circle terms for reference in the computer program.

be regarded as deterministic, ie assumed to have an actual value equal to the values given by the finite element analysis, and that  $c_i$ ,  $u_i$  and  $\tan \phi_i$  are independent random variables with known means and standard deviations (where the means of  $c$  and  $\phi$  apply to the entire length of wall and the standard deviations represent the variations that can occur between sections,  $c$  and  $\phi$  being constant for one material for any one section). With these assumptions  $F$  is deterministic for a given failure surface, and  $R$  is a random variable.

#### Distribution of Total Resistance, R

9. The resistance,  $R$ , is the sum of a number of random variables, the resistances at each finite element. Because the random variables are generally independent, by the central limit theorem  $R$  will be approximately normally distributed. It is, therefore, assumed that  $R$  is a normally distributed random variable with parameters  $M_R$ , the mean value of  $R$ , and  $S_R$ , the standard deviation of  $R$ . The mean is determined as follows:

$$M_R = \sum_{i=1}^n \lambda_i (M_c + \{\sigma - M_u\} M_{\tan \phi}) \quad \text{eq A-1}$$

The standard deviation squared is the variance, ie  $\text{Var}[R] = S_R^2$ .

$$\text{Var}[R] = \text{Var}\left[\sum_{i=1}^n \lambda_i \{c_i + (\sigma_i - u_i) \tan \phi_i\}\right]$$

where  $\sigma_i$  and  $\lambda_i$  being deterministic are treated as constants. From statistical theory:

$$\begin{aligned} \text{Var}\left[\sum_{i=1}^k a_i X_i\right] &= \sum_{i=1}^k a_i^2 \text{Var}[X_i] \\ &+ 2 \sum_{i=1}^k \sum_{j=i+1}^k a_i a_j \text{Cov}[X_i, X_j] \end{aligned}$$

where  $a$  is a constant and  $X$  is a variable. Hence:

$$\begin{aligned} \text{Var}[R] &= \sum_{i=1}^n \lambda_i^2 \{\text{Var}[c_i] + \sigma_i^2 \text{Var}[\tan \phi_i] \\ &+ \text{Var}[u_i \tan \phi_i]\} + 2 \sum_{i=1}^n \sum_{j=i+1}^n \lambda_i \lambda_j \{\sigma_j \text{Cov}[c_i, \tan \phi_j] \\ &- \sigma_i \text{Cov}[\tan \phi_i, u_j \tan \phi_j] - \text{Cov}[u_i \tan \phi_i, c_j]\} \end{aligned}$$

$$\begin{aligned} &+ 2 \sum_{i=1}^n \sum_{j=i+1}^n \lambda_i \lambda_j \{\text{Cov}[c_i, c_j] \\ &+ \sigma_i \sigma_j \text{Cov}[\tan \phi_i, \tan \phi_j] + \text{Cov}[u_i \tan \phi_i, u_j \tan \phi_j]\} \end{aligned} \quad \text{eq A-2}$$

10.  $\text{Cov}[a, b]$  is the covariance of  $a$  and  $b$ . The covariance is a measure of the linear dependence between two variables. The covariance and the variances of the variables may be written as:

$$\text{Cov}[a, b] = \rho_{a,b} \sqrt{\text{Var}[a] \cdot \text{Var}[b]}$$

where  $\rho_{a,b}$  is the correlation coefficient. This coefficient always lies in the range  $-1 \leq \rho_{a,b} \leq 1$ . In the context of slope failure, a correlation coefficient of 1 indicates dependence between the variables (in this case between  $c_i$  and  $c_j$ ,  $c_i$  and  $\phi_i$ , etc). A correlation coefficient of zero indicates independence.

11. To determine  $\text{Var}[R]$ , the values of  $\text{Var}[c_i]$ ,  $\text{Var}[\tan \phi_i]$  and  $\text{Var}[u_i]$  are known, together with the mean values of  $c_i$ ,  $\phi_i$  and  $u_i$  (the treatment of  $u_i$  is described below).  $c$ ,  $\phi$  and  $u$  are assumed to be mutually independent.

12.  $\text{Var}[u_i \tan \phi_i]$  must be expanded.  $u_i$  and  $\phi_i$  being independent leads to:

$$\begin{aligned} \text{Var}[u_i \tan \phi_i] &= E[u_i]^2 \text{Var}[\tan \phi_i] \\ &+ E[\tan \phi_i]^2 \text{Var}[u_i] + \text{Var}[u_i] \text{Var}[\tan \phi_i] \end{aligned}$$

Note that the notation  $E[x]$ , the expected value of  $x$ , is the same as the mean value, previously designated as  $M_x$ .

13. Because  $c_i$  and  $\phi_i$  are independent,  $\text{Cov}[c_i, \tan \phi_i] = 0$ .

$$\begin{aligned} \text{Cov}[\tan \phi_i, u_j \tan \phi_j] &= E[\tan \phi_i \cdot u_j \tan \phi_j] \\ &- E[\tan \phi_i] E[\tan \phi_j \cdot u_j] \end{aligned}$$

$u_j$  being independent of  $\phi_i$  and  $\phi_j$ :

$$E[\tan \phi_j \cdot u_j] = E[\tan \phi_j] E[u_j]$$

$$\begin{aligned} E[\tan\phi_i \cdot u_j \tan\phi_j] &= E[\tan\phi_i \tan\phi_j] E[u_j] \\ &= \{E[\tan\phi_i] E[\tan\phi_j] + \text{Cov}[\tan\phi_i, \tan\phi_j]\} E[u_j] \end{aligned}$$

Therefore  $\text{Cov}[\tan\phi_i, u_j \tan\phi_j]$

$$= E[u_j] \text{Cov}[\tan\phi_i, \tan\phi_j]$$

14. Because  $u_i$ ,  $\phi_i$  and  $c_j$  are independent,  $\text{Cov}[u_i \tan\phi_i, c_j] = 0$ , and knowing then that  $E[u_i \tan\phi_i] = E[u_i] E[\tan\phi_i]$  and  $E[u_j \tan\phi_j] = E[u_j] E[\tan\phi_j]$

$$\begin{aligned} \text{Cov}[u_i \tan\phi_i, u_j \tan\phi_j] &= E[u_i \tan\phi_i \cdot u_j \tan\phi_j] \\ &\quad - E[u_i \tan\phi_i] E[u_j \tan\phi_j] \end{aligned}$$

and  $E[u_i \tan\phi_i \cdot u_j \tan\phi_j] = E[u_i u_j] E[\tan\phi_i \tan\phi_j]$

$$E[u_i u_j] = E[u_i] E[u_j] + \text{Cov}[u_i, u_j]$$

$$E[\tan\phi_i \tan\phi_j] = E[\tan\phi_i] E[\tan\phi_j] + \text{Cov}[\tan\phi_i, \tan\phi_j]$$

Therefore  $\text{Cov}[u_i \tan\phi_i, u_j \tan\phi_j]$

$$\begin{aligned} &= E[u_i] E[u_j] \text{Cov}[\tan\phi_i, \tan\phi_j] \\ &+ E[\tan\phi_i] E[\tan\phi_j] \text{Cov}[u_i, u_j] \\ &+ \text{Cov}[u_i, u_j] \text{Cov}[\tan\phi_i, \tan\phi_j] \end{aligned}$$

15.  $\text{Cov}[c_i, c_j]$  represents the correlation between the cohesion on the  $i^{\text{th}}$  and  $j^{\text{th}}$  chords. If the  $i^{\text{th}}$  and  $j^{\text{th}}$  chords lie in the same material, it is assumed that  $c_i$  and  $c_j$  are completely correlated, i.e. have the same value, hence  $\text{Cov}[c_i, c_j] = \sqrt{\{\text{Var}[c_i] \text{Var}[c_j]\}} = \text{Var}[c_i]$ . If the  $i^{\text{th}}$  and  $j^{\text{th}}$  chords lie in different materials, it is assumed that  $c_i$  and  $c_j$  are completely uncorrelated, hence  $\text{Cov}[c_i, c_j] = 0$ .

16. Similarly, if the  $i^{\text{th}}$  and  $j^{\text{th}}$  chords lie in the same material  $\text{Cov}[\tan\phi_i, \tan\phi_j] = \text{Var}[\tan\phi_i]$ . Otherwise,  $\text{Cov}[\tan\phi_i, \tan\phi_j] = 0$ . Different materials in this context mean geologically different soil or rock types at different chords of the circular surface. The strength parameters

from these regions will be independent. Eq A-2 can be re-written in terms of the mean values, variances and covariances of  $c$ ,  $\phi$  and  $u$ .

17. Given  $E[\phi_i]$  and  $\text{Var}[\phi_i]$ , it can be shown that  $E[\tan\phi_i] = \tan(E[\phi_i])$  and  $\text{Var}[\tan\phi_i] = \sec^4(E[\phi_i]) \text{Var}[\phi_i]$  to a good approximation.

18. Pore pressure,  $u$ , is not as easily handled. The approach used here is to let the random nature of pore pressure be represented by a varying phreatic surface as shown in Fig A-3. The phreatic surface will be some smooth, continuous surface between the limiting surfaces A and B. Let  $x_i, y_i$  be some point on the true surface. Then  $y_i = y_{ib} + \alpha_i (y_{ia} - y_{ib})$ , where  $\alpha_i$  is a random variable. When  $\alpha_i$  is zero, the phreatic surface coincides with B; when  $\alpha_i$  is unity, it coincides with A. Alternate probability density functions (PDF) for  $\alpha_i$  are shown in Fig A-4.

19. The pore pressure,  $u_i$ , at some point  $P(x_i, y_p)$  below the phreatic surface, is strictly speaking not related to  $y_i$  but to  $y$  of some nearby point that lies on the equipotential line through P. For convenience, however, it is assumed that:

$$u_i = \gamma_w (y_i - y_p) \quad y_i \geq y_p$$

$$u_i = 0 \quad y_i \leq y_p$$

where  $\gamma_w$  is the unit weight of water. Thus  $u_i$  is either zero or a linear function of  $\alpha_i$ .

20. Consider a second point  $x_j, y_j$  on the phreatic surface. There will be a correlation between  $\alpha_i$  and  $\alpha_j$ , and hence between  $u_i$  and  $u_j$ . For simplicity, it is assumed that  $\alpha_i = \alpha_j$  for all  $(i, j)$ . All vertical lines between surfaces A and B are divided in a constant ratio by the phreatic surface.

21. The mean, variance and covariance of  $u$  may be determined once the probability distribution function, PDF, of  $\alpha$  is known. For simplicity, a uniform distribution of  $\alpha$  between 0 and 1 is assumed.

$$\text{Hence the mean of } u_i = \gamma_w (y_{ib} - y_p + \alpha (y_{ia} - y_{ib}))$$

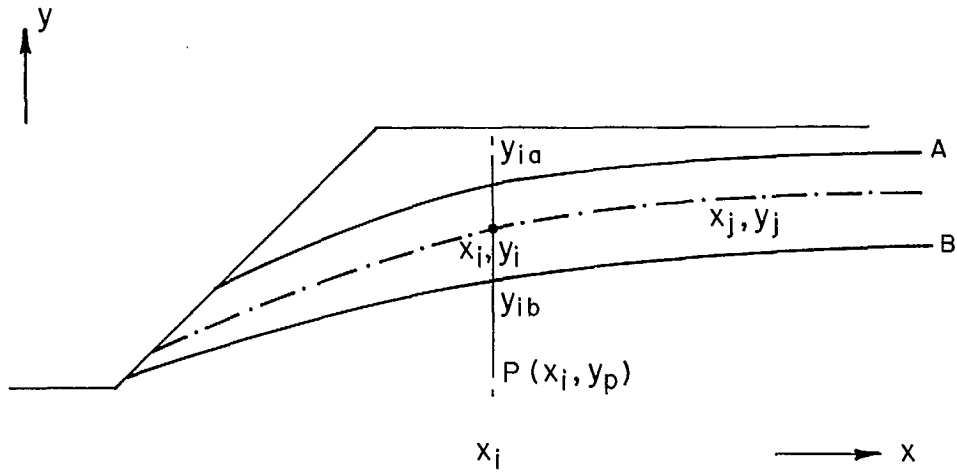

Fig A-3 Upper, A, and lower, B, limits to the variation of the annual maximum phreatic surface.

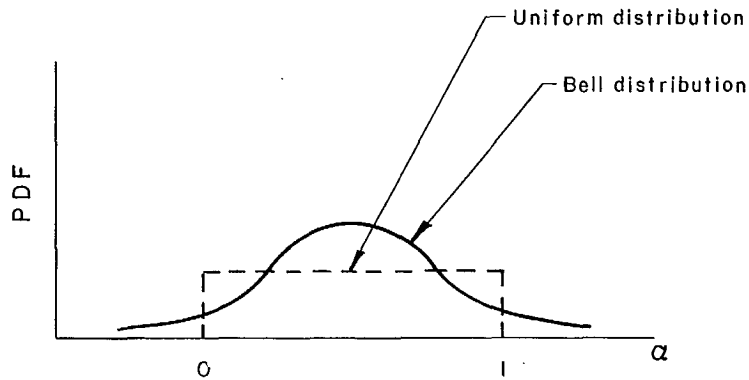

Fig A-4 Various probability density functions, PDF, for the variation of the maximum annual phreatic surface.

for  $y_i \geq y_p$  and elsewhere,  $u_i = 0$

22. The probability density function for  $\alpha$  is  $f(\alpha) = 1$  for  $0 \leq \alpha \leq 1$ , and elsewhere  $f(\alpha) = 0$ . The limits for  $\alpha$ , ie the range where both  $f(\alpha)$  and  $u_i$  are non-zero, are

$$0 \leq \alpha \leq 1 \quad \text{for } y_p \leq y_{ib}$$

$$\frac{y_p - y_{ib}}{y_{ia} - y_{ib}} \leq \alpha \leq 1 \quad \text{for } y_{ib} \leq y_p \leq y_{ia}$$

no limits for  $y_p > y_{ia}$  (ie  $u_i = 0$  everywhere).

Therefore  $E[u_i]$

$$\gamma_w \int_{t_i}^1 (y_{ib} - y_p + \alpha(y_{ia} - y_{ib})) f(\alpha) d\alpha$$

where  $t_i = 0$  for  $y_p \leq y_{ia}$

$$t_i = (y_p - y_{ib}) / (y_{ia} - y_{ib}) \quad \text{for } y_{ib} \leq y_p \leq y_{ia}$$

$$t_i = 1 \quad \text{for } y_p \geq y_{ia}$$

Let  $f_i = y_{ia} - y_{ib}$  and  $g_i = y_{ib} - y_p$ .

Then  $E[u_i]$

$$\begin{aligned} &= \gamma_w \left[ g_i \alpha + \frac{f_i \alpha^2}{2} \right]_{t_i} \\ &= \gamma_w \left\{ g_i (1 - t_i) + \frac{f_i}{2} (1 - t_i^2) \right\} \end{aligned}$$

23. From statistical theory, it is known that the variance of  $u_i$ ,  $\text{Var}[u_i] = E[u_i^2] - E[u_i]^2$ . Hence:

$$\begin{aligned} \text{Var}[u_i] &= \gamma_w^2 \int_{t_i}^1 (f_i \alpha + g_i)^2 f(\alpha) d\alpha - E[u_i]^2 \\ &= \gamma_w^2 \left\{ \frac{f_i^2 (1 - t_i^3)}{3} + f_i g_i (1 - t_i^2) + g_i^2 (1 - t_i) \right\} \\ &\quad - E[u_i]^2 \end{aligned}$$

24. The covariance of  $u_i$  and  $u_j$ ,  $\text{Cov}[u_i, u_j] = E[u_i u_j]$ . The product  $u_i u_j$  is a function of one variable,  $\alpha$ , such that:

$$u_i u_j = \gamma_w^2 (f_i \alpha + g_i)(f_j \alpha + g_j) \quad \text{for } u_i > 0 \text{ and } u_j > 0$$

$$u_i u_j = 0 \quad u_i = 0 \text{ or } u_j = 0.$$

Thus  $u_i u_j$  is non-zero for a range of  $\alpha$  such that:

$$1 \geq \alpha \geq 0 \quad \text{if } y_p \leq y_{ib} \text{ and } y_q \leq y_{jb};$$

$$1 \geq \alpha \geq \text{the greater of } \frac{(y_p - y_{ib})}{(y_{ia} - y_{ib})} \text{ and } \frac{(y_q - y_{jb})}{(y_{ja} - y_{jb})}$$

if  $y_{ib} \leq y_p \leq y_{ia}$  or  $y_{jb} \leq y_q \leq y_{ja}$ ; and  $\alpha$

has no limits if  $y_p > y_{ia}$  or  $y_q > y_{ja}$  ie  $u_i u_j = 0$ .

Here  $y_q$  is the ordinate of the slip circle under the point  $x_j$ ,  $y_j$  on the phreatic surface. If  $t_j$  is defined as:

$$t_j = 0 \quad \text{for } y_q \leq y_{jb};$$

$$t_j = \frac{y_q - y_{jb}}{y_{ja} - y_{jb}} \quad \text{for } y_{jb} \leq y_q \leq y_{ja}; \text{ and}$$

$$t_j = 1 \quad \text{for } y_{ja} \leq y_q,$$

then the range of  $\alpha$  for which  $f(\alpha)$  and  $u_i u_j$  are both non-zero is  $T \leq \alpha \leq 1$ , where  $T$  is the greater of  $t_i$  and  $t_j$ .

Therefore

$$E[u_i u_j] = \gamma_w^2 \int_T^1 (f_i \alpha + g_i)(f_j \alpha + g_j) f(\alpha) d\alpha$$

Therefore

$$E[u_i u_j] = \gamma_w^2 \left[ f_i f_j \frac{\alpha^3}{3} + \frac{(g_i f_j + g_j f_i)}{2} \alpha^2 + g_i g_j \alpha \right]_T^1$$

$$\text{and } \text{Cov}[u_i, u_j] = \gamma_w^2 \left\{ \frac{f_i f_j}{3} (1 - T^3) \right.$$

$$\left. + \frac{(g_i f_j + g_j f_i)}{2} (1 - T^2) + g_i g_j (1 - T) \right\}$$

$$- E[u_i] E[u_j]$$

25. Equation 11 can be written now as:

$$\text{Var}[R] = \sum_{i=1}^n \lambda_i^2 \{ \text{Var}[c_i] + \sigma_i^2 \text{Var}[\tan \phi_i]$$

$$+ E[u_i]^2 \text{Var}[\tan \phi_i] + E[\tan \phi_i]^2 \text{Var}[u_i]$$

$$\begin{aligned}
& + \text{Var}[u_i] \text{Var}[\tan\phi_i] \\
& - 2 \sum_{i=1}^n \sum_{j=i+1}^n \ell_i \ell_j \sigma_i E[u_j] \text{Var}[\tan\phi_i] \\
& + 2 \sum_{i=1}^n \sum_{j=i+1}^n \ell_i \ell_j \{ \text{Var}[c_i] \\
& + \text{Var}[\tan\phi_i] (\sigma_i \sigma_j + E[u_i] E[u_j] + \text{Cov}[u_i, u_j]) \} \\
& + 2 \sum_{i=1}^n \sum_{j=i+1}^n \ell_i \ell_j E[\tan\phi_i] E[\tan\phi_j] \text{Cov}[u_i, u_j]
\end{aligned}$$

eq A-3

The summations marked by \* are only for chords in a common material.

#### Determination of Shear Force, F

26. The data required from the prior finite element analysis are the normal stresses in the x and y-directions and the shear stress in the x and y-directions, ie three stress values for each element. Stresses are needed at the mid-point of each of the chords that are used to approximate the slip circle. These stresses are determined by interpolating from the values for the nearest elements in each of the four quadrants surrounding the chord. The following equation is used for interpolation:

$$\sigma = \sum_{i=1}^4 \sigma_i / Q r_i$$

where  $\sigma_i$  is the stress for the i'th element,  $r_i$  is the distance from the chord to the centroid of the i'th element, and  $Q = \sum 1/r_i$ ,  $i = 1$  to 4. If a quadrant around the chord does not contain an element, this quadrant is ignored.

27. The stresses at the centre of each chord are resolved perpendicular and parallel to the direction of the chord to give the normal stress,  $\sigma$ , and shear stress,  $\tau$ , along the chord. The shear stress, multiplied by the chord length, is the force tending to produce slip. These forces are summed algebraically over the length of the circle to give the total driving force, F.

#### Probability of Sliding

28. The probability of sliding is given by  $P_f = P[R < F]$ ; hence by subtracting and dividing

common terms:

$$P_f = P\left[\frac{R-M_r}{S_r} < \frac{F-M_r}{S_r}\right] = P[Z < \frac{F-M_r}{S_r}]$$

where Z is the standardized normal variable. In SLOPROB a subroutine is used to calculate this probability once the right hand side of the inequality has been determined.

#### PROGRAM PROCEDURE

##### Slip Circle

29. A circular failure arc, or slip circle, is specified in the program by the co-ordinates of the circle centre and either one point through which the circle passes or by a line which is tangential to the slip circle. The determination of the circle is then a matter of geometry. The circle is approximated by a number of chords, and the locations of these chords determined.

30. The slope is defined by the coordinates of the toe and the crest. For slip circle purposes, the slope is defined by the horizontal line through the toe, the horizontal line through the crest, and the line joining the toe and the crest. (This definition is for geometrical convenience, and puts no limitation on the geometry of the original finite element analysis.) The program determines the points at which the slip circle meets the lines defining the slope. For convenience the point nearest the toe is called the entry point of the circle, and the point nearest the crest is called the exit point. The location of the entry point and exit point are checked to determine if the slip circle falls outside the inclined part of the slope; if so, this circle is ignored.

##### Search for Critical Circle

31. The range of circles searched is specified by the user. The grid of trial centres for homogeneous ground would usually cover the area around a point at a height above the crest elevation equal to the slope height, H, and H into the pit from the toe. A region of circle centres is divided into a grid by user input parameters.

Circles are centred on each point of this grid in turn.

32. If the circles are defined by a centre and a specified point on the circle (the alternative being a centre and a line which the circles touch), then a range of such specified points may also be given. In homogeneous ground, the toe would usually be the specified point. Otherwise, the range is specified by the extreme points of the range and the number of such points. The individual points will be equally spaced on the line joining the extremes; the program reduces the y coordinates of these points if necessary to bring them within the slope. Typically, a range of entry points can be specified in this way.

33. For each circle, the probability of sliding is determined, and the critical circle is that with the highest probability of sliding. SLOPROB searches for the critical circle on a grid pattern. It may be necessary to run SLOPROB 2 or 3 times with revised grids for each slope profile to ensure the critical circle is located.

#### Flow Chart

34. Figure A-5 shows a simplified flow chart for SLOPROB, and Fig A-6 shows the subroutine PROBRSF where the probability of sliding and the safety factor is calculated.

### PROGRAM LIMITATIONS AND CAPABILITIES

#### Finite Element Data

35. Storage of the stresses produced by the finite element program is provided in the program for up to 1000 elements. Each element has an x-stress, a y-stress and an xy-shear stress. The user may specify a rectangular region outside which elements are not to be considered (ie they are outside the region of possible slip circles). Elements are checked on input, and only data for elements inside this region is actually stored. The user may also specify a region around each slip circle within which the search for the nearest element to a chord will be restricted, thus reducing the machine time required.

36. Each element is assigned the Material Type

1 on input; this may be changed at the programmer's option by reading in the relevant values and the rectangular area to which this material type applies. Up to ten different material types corresponding to different sets of mechanical properties can be used.

#### Slip Circles

37. To define the slip circles, up to 50 specified points can be considered at one time. These are determined by specifying two points and the number of divisions. Points equally spaced along this line are used as specified points on the circle. If they are on the slope boundary, they are taken as entry points; if within the slope they are taken merely as points on the circle. Should any specified point lie outside the slope, then the nearest point on the slope with the same x-coordinate is taken as the circle entry point. Up to 100 chords may be used to approximate the slip circle; each of these will have the same chord length.

38. The program will handle slopes of any slope angle. Slope angle is defined for purposes of the slide analysis as the angle between the horizontal and the line joining the toe and the crest.

#### Sign Convention

39. Positive stresses in the program are compression and upward shear on the right hand side of an element (shown in Fig A-7). However, provision is made for finite element stresses of any sign convention to be accepted.

#### Checks

40. Data is checked on input for obvious errors, eg crest lower than toe, and appropriate error messages produced. An attempt has been made to eliminate the possibility of dividing by zero in the program; special checks are used to assign an appropriate value to the variable involved without performing the division.

#### Sensitivity

41. The parameters of most importance are the

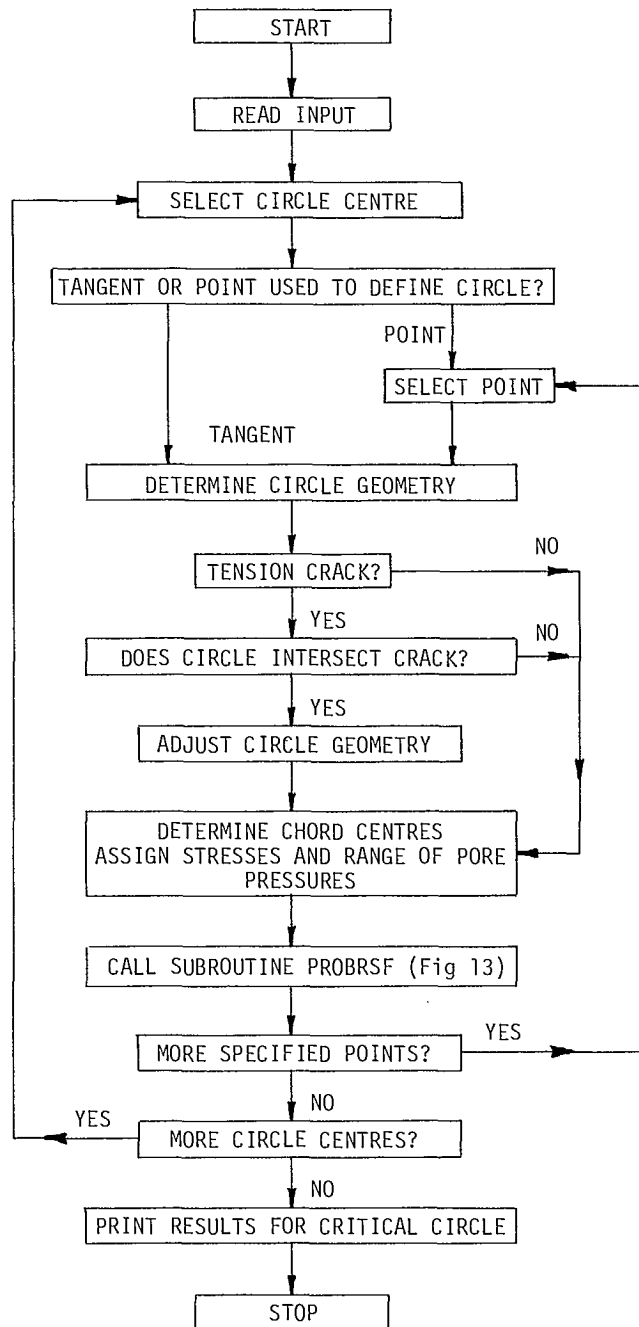

Fig A-5 Flow chart for SLOPROB, the computer program for computing the probability of instability of a slope with a potential mode of instability by rotational shear.



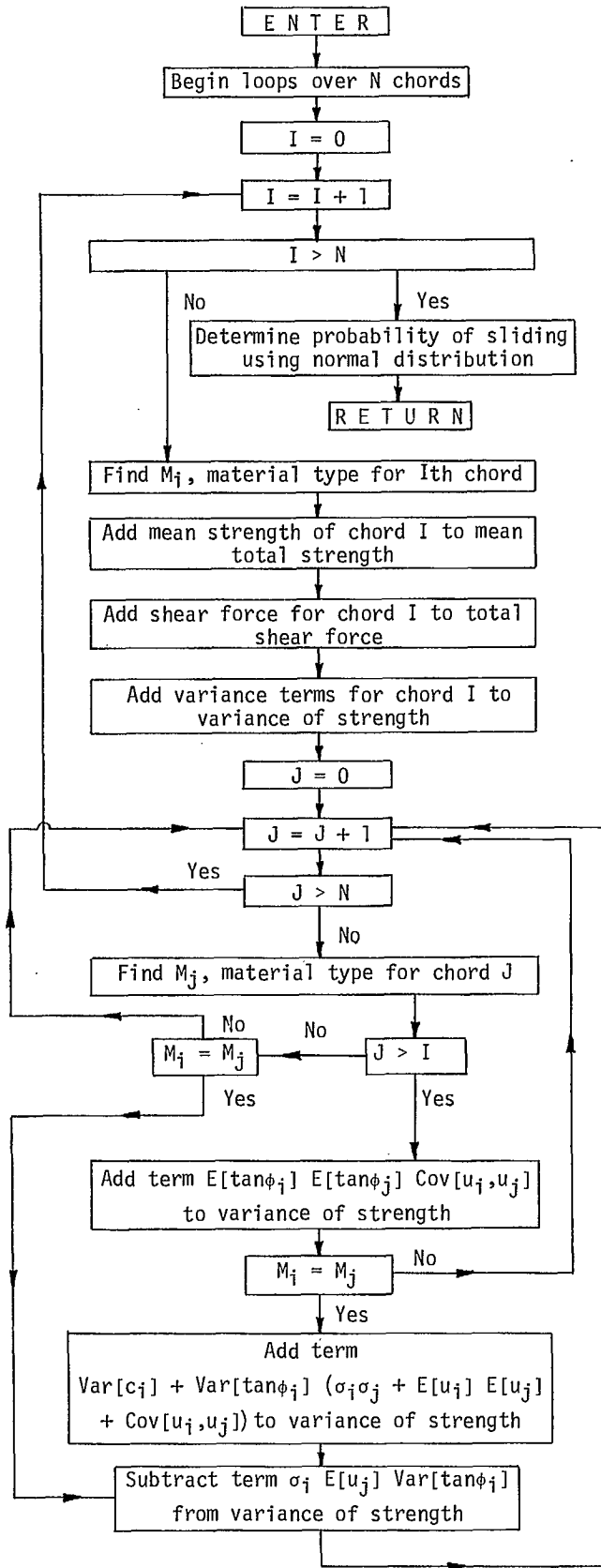

Fig A-6 Flow chart for sub-routine PROBRSF of the program SLOPROB.

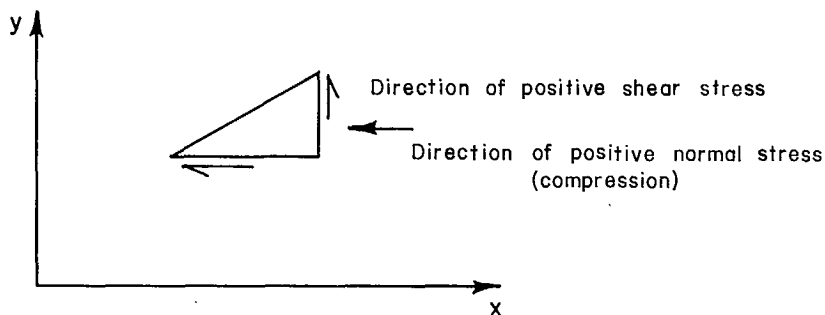

Fig A-7 Sign convention for stresses.

number of finite elements in the original analysis, the number of chords used to approximate the slip circle, and the location and number of circles used in the search for the critical circle.

42. The number of elements used is not a variable in SLOPROB, but depends upon the prior finite element analysis. Initial studies with the program show that any finite element analysis that adequately models the stress distribution in the slope will be adequate also for SLOPROB. Typically, a slope analysis with 200 - 1000 elements appears adequate.

43. Initial use of the program also indicates that 30 chords gives an adequate approximation of the slip circle. There is a negligible difference in results obtained using 30 and 100 chords.

44. The location of the region of circle centres is critical. For homogeneous ground the grid of circle centres would cover the area around the point that is at an elevation above the crest equal to the slope height,  $H$ , and usually at a distance into the pit from the toe equal to  $H(4)$ .

The technique used to date is first to run the program with a coarse mesh of circle centres, and then by inspection select a more critical region for closer examination in a second run.

#### "Floating" of Pore Pressure

45. Mean pore pressures greater than the normal stress on a chord are assumed not to arise, i.e., the excess pressure would dissipate. If the normal stress is less than mean pore pressure, the term  $(\sigma - u)$  is set equal to zero. Negative resisting forces can therefore not occur.

#### Program Options

46. The following options are available. A vertical tension crack may be considered in the program. The crack is defined by the coordinates of the bottom of the crack. A check is made in the program to see if the slip circle intersects the tension crack. If so, this intersection point is taken as the exit point of the circle. A tension crack can be incorporated whether or not the original finite element solution included such

a crack. However, an accurate analysis will call for a crack to be simulated in the original finite element stress analysis. Sign convention on input for normal stresses or shear stresses may be changed. The slope direction may be either to the left or right, ie face in the direction of either increasing or decreasing x. Slip circles can be defined either by a centre and a specified point or by a centre and a tangent to all circles. Input devices may be specified by the unit number, eg the finite element input is typically from a mass storage unit, not the card reader.

## DATA REQUIREMENTS

### General

47. Input data consists of: the results of the finite element analysis; Mohr strength parameters for each type of material; pore water pressures; the geometry of the slope; tension crack coordinates and details of the slip circles to be analysed. A series of logical variables is input also, to control the program options.

48. The units used can be any consistent system, eg lb-ft-sec or SI; the system used in the finite element analysis must be followed in SLOPROB.

### Sources

49. The finite element analysis and its own data requirements are described in Appendix B. The determination of values for the Mohr strength parameters is described in the chapter on Mechanical Properties. The pore pressures are determined from the limiting phreatic surfaces, ie from maximum and minimum positions of the phreatic surface. The determination of these limiting positions is described in the chapter on Groundwater. The remaining data is specified by the user (eg, the positions of the trial slip circles).

### Finite Element Data

50. For each element in turn, the following data is needed in the order given: x and y-coordinates of the element centre, the normal stresses

in the x and y-directions and xy-shear stress. Apart from order, provision is made for the user to specify his own input format.

### Material Data

51. For each material (up to 10 materials are allowed) values for mean and standard deviation of cohesion, and mean and standard deviation of the angle of internal friction, are required. Material 1 is automatically assigned to the whole slope. For each material other than 1, the x and y-boundaries of a rectangular region must be input; the material number is assigned to replace material 1 within this region.

### Pore Water Pressures

52. Pore water pressure is considered by means of limiting phreatic surfaces, ie an upper and lower surface are given, representing the limits due to variation in time or inaccuracy in measurement. Up to 50 points (x, y) may be used to define each surface. If no surfaces are given pore water pressures are ignored. If one surface only is given, the mean value of pore pressure is given by this surface, and the standard deviation is taken as zero.

### Slope Geometry

53. The coordinates of the toe and crest are input, and the coordinates of the bottom of a tension crack, if one is included, are input.

### Slip Circle Data

54. The x and y-boundaries of a rectangular region of slip circle centres are required, and the number of grid divisions in the x and y-directions of this region. Unless other guidance is available, an initial trial area can be centered on a point at a distance into the pit from the toe equal to the slope height, H, and at an elevation above the crest equal to H. The width of the grid can be equal to H, and the height equal to H/2.

55. The coordinates of a specified point through which the circles pass are required (or the extreme points if a range of specified points is used). Alternatively, a line which the circles

touch is specified by giving the coordinates of two points on the line.

#### Printed Output

56. Output consists of the input data, followed by the results of each cycle, ie each circle analysed. The results of the critical circle are repeated at the end of the output.

57. Additional output is available at the user's option. The Namelist parameter PRINT provides the option of having the output of the Namelist variables, the coordinates defining the region of stored element data, the width of the region around each circle to be searched for assignment of stresses, and the coordinates defining the regions of material number changes. The Namelist parameter PNTTEL controls the output of the stresses and centroid coordinates of the finite elements.

#### Data Input

58. Data is provided in three groups.

- a. A group of free format data cards using the Fortran NAMELIST option contain the logical variables and some of the program control variables. The last card of this group carries the format for the input of the finite element program results.
- b. A disk or tape file (or if desired a card deck) contains the results from the finite element analysis.
- c. The material and pore pressure parameters, slope geometry and the remaining control variables are put on cards in a fixed format.

#### Group (a)

59. The Fortran NAMELIST is named DATA in SLOPROB. It consists of a series of variables, which are assigned default values in the program. A different value may be assigned to any or all of these variables by a conventional Fortran assignment statement included in the input data. The variables are as follows:

<u>Variable</u>	<u>Type</u>	<u>Default</u>	<u>Description</u>
COMPOS	Logical	.TRUE.	Used for sign convention of input normal stresses. COMPOS = .FALSE. means input stresses will be treated as tension positive.
CRACK	Logical	.FALSE.	CRACK = .TRUE. indicates a tension crack is to be considered. Relevant data is input in Group (c).
FLEFT	Logical	.TRUE.	FLEFT = .TRUE. indicates the slope faces left, ie faces the direction of decreasing x. If the slope faces right then FLEFT must be assigned the value .FALSE.
GAMMA	Real	62.4	Unit weight of water. Used to determine pore pressures. Value must be consistent with users system of units.
ICR	Integer	5	Unit number of the card reader. Range depends on user's system.
IPR	Integer	6	Unit number of the line printer. Range depends on user's system.
ITR	Integer	8	Unit number of the device carrying finite element results. It can be assigned the unit number of the card reader if desired. Range depends on user's system.
MCH	Integer	0	Number of regions requiring a changed material number, ie a material number other than 1. Change information if necessary is included in Group (b). Any integer greater than or equal to zero is valid.
NCDIV	Integer	30	Number of chords used to approximate slip circle. Allowable range 2 to 100.
NEL	Integer	0	Number of elements in original finite element analysis.
NMAT	Integer	1	Number of different materials in slope. Relevant data for material properties is input in Group (c). Valid range 1 to 10.

<u>Variable</u>	<u>Type</u>	<u>Default</u>	<u>Description</u>
NPI	Integer	0	Number of points defining upper limit to phreatic surface. Valid range 2 to 50, or 0.
NP2	Integer	0	Number of points defining lower limits to the phreatic surface. Valid range 2 to 50, or 0. (if NPI = 0, NP2 must be 0.)
NPT	Integer	5	Number of specified points through which trial circles pass. Only one point is used per circle; each circle centre is used with each specified point in turn to create a trial circle. NPT is only used if two extreme specified points are input in Group (b). Valid range 2 to 50.
NRX	Integer	5	Number of divisions in the x-direction of the region of circle centres. Used to form the grid of circle centres. Any positive integer is valid.
NRX	Integer	5	Number of divisions in the y-direction of the region of circle centres. Used to form the grid of circle centres. Any positive integer is valid.
PNTEL	Logical	.FALSE.	PNTEL = .TRUE. results in output of data from the finite element analysis.
PRINT	Logical	.FALSE.	PRINT = .TRUE. results in additional output of data.
RHSPOS	Logical	.TRUE.	RHSPOS = .FALSE. reverses the sign convention used to input shear stresses (sign convention is shown in Fig 14).
TANG	Logical	.FALSE.	TANG = .TRUE. indicates circles are to be defined by a centre and a tangent. Two points defining the tangent are input in Group (c).

60. The first card of Group (a) must carry the characters \$DATA in columns 2 to 6. This indicates the beginning of the Namelist. On the same card, or on subsequent cards, in any column except column 1, Fortran statements re-defining the Namelist variables may appear. Any or all the variables may be redefined, in any order; the variable NEL at least must be re-defined for the program to run (it has a default of zero). Each statement must be followed by a comma on the same card. The end of the statements is marked by a \$ character, in any column except column 1.

61. A typical set of cards would appear as follows:

```
$DATA
  COMPOS = .FALSE.,
  MCH = 2, TANG = .TRUE.,
  $
```

62. All variables other than those re-defined in the Namelist will retain their default values. The next card carries a title (Format 8 A 10). The subsequent card carries the format for reading finite element results. This is punched in conventional Fortran format, including the enclosing brackets; only 80 columns are allowed. A typical card is: (2F10.4, 10X, 3E12.4). Note that unwanted finite element data can be bypassed by spacing.

#### Group (b)

63. The results from the prior finite element analysis may be input on cards or from a mass storage device. The user specifies the format in Group (a); the device used is governed by the Namelist parameter ITR.

64. The data for each element must be contained in one record. The order of data must be as follows:

X-coordinate of element centre - XY (I,1) for the I'th element;

Y-coordinate of element centre - XY (I,2) for the I'th element;

$\sigma_x$ , normal stress in x-direction;

$\sigma_y$ , normal stress in y-direction; and

$\tau_{xy}$ , shear on x and y planes.

The sign convention for stresses is governed by Namelist variables COMPOS and RHSPPOS.

#### Group (c)

65. Information in Group (c) comprises the geometry of the slope (defined by coordinates of the toe and crest), material properties and regions if more than one material type is required, information governing the circle generation, (ie the region of circle centres and either a specified point or a tangent) the coordinates of the bottom of a tension crack if required, and the points defining the phreatic surfaces, if required.

66. The cards required are as follows:

1 card - XL1, XL2, YL1, YL2, RDIST (max and min X and y - coordinates of the region of stored finite element data and half width annulus around slip surface searched for elements).

(Finite element data, if input on cards, follows here)

1 card - XTOE, YTOE, XCREST, YCREST (coordinates of toe and crest). Format (4F 10.4)

MCH cards, where MCH is the material change parameter defined in Namelist DATA (Group (a)). Each card - MAT, XMIN, XMAX, YMIN, YMAX (minimum and maximum x and y values defining a region to be assigned the material number MAT). Format (I10, 4F10.4). If only one material is used in the slope, MCH = 0 and no cards of this type are included. There is no limit to the number of these cards.

NMAT cards, where NMAT is the number of materials used in the slope, defined in Namelist DATA. Note that MCH can be greater than NMAT, eg if the same material properties apply to two or more distinct regions. Each card - MAT, (CPHI(MAT,I), I = 1,4) contains the mean cohesion, standard deviation of cohesion, mean  $\phi$ , standard deviation of  $\phi$ .  $\phi$ , the angle of internal friction, is input in degrees for both mean and standard deviation. Format (I10, 4F10.4). At least 1 card and not more than 10 cards are required.

1 card containing the x and y-boundaries of the region of circle centres and either one specified

point through which circles pass, or a pair of specified points defining the limits of a range of specified points (the range to be divided into NPT separate points, where NPT is defined in Namelist DATA) or a pair of points defining a tangent to all circles. If a tangent is not defined (TANG = .FALSE., where TANG is a variable in the Namelist DATA) then the card contains: RX1, RX2, RY1, RY2, TLINE(1), TLINE(2), TLINE(3), TLINE(4) (minimum and maximum x and y-boundaries of the region of circle centres, the x and y-coordinates of one specified point and the x and y coordinates of a second specified point. If the coordinates of the second point are both zero, ie blanks or zero are input, then the first specified point is taken as the only specified point. Otherwise a range of specified points is assumed, and the parameter NPT used to form the intermediate specified points). If a tangent is defined (TANG = .TRUE) then the card contains: RX1, RX2, RY1, RY2, TLINE(1), TLINE(2), TLINE(3), TLINE(4) (minimum and maximum x and y-boundaries of the region of circle centres, and the x and y-coordinates of two points defining the tangent, ie  $x_1, y_1, x_2, y_2$ , where the suffixes denote the first and second point. The origin, ie zero coordinates, is a valid point for defining a tangent). Format (8F10.4).

lCard containing the coordinates of the bottom of a tension crack. This card is only required if CRACK = .TRUE., where CRACK is a variable in the Namelist DATA. The card contains XTC, YTC (x and y-coordinates of the tension crack). Format (2F10.4)

NP1 cards where NP1 is the number of points defining the upper limit to the phreatic surface specified in Namelist DATA. If NP1 is zero no cards are needed. Each card contains x and y-coordinates of one point on the surface. Points must be in order of increasing x-coordinates. Format (2F10.4)

NP2 cards where NP2 is the number of points defining the lower limit to the phreatic surface, specified in Namelist DATA. If NP2 is zero no cards are needed (if NP1 is zero NP2 must also be zero). Each card contains x and y-coordinates of one point on the surface. Points must be in order

of increasing x-coordinates. Format (2F10.4)

## SOURCE PROGRAM

### Main Program

67. The main program determines the coordinates of the centre of the slip circle, calls subroutines that perform the major part of the analysis, stores intermediate results, and prints the intermediate and final results.

### Subroutines

68. CHORD determines the positions and inclinations of the chords used to approximate the slip circle. It calls the library subroutines ABS, ATAN, COS and SIN.

69. CIRCLE determines the geometry of the slip circle, ie the exit point and entry point if necessary, and the orientations and positions of the chords used to approximate the circle. This subroutine also checks for reality of the slip circle, eg whether or not the slip circle includes the inclined section of the slope. It calls the subroutine MEET, and the library subroutines ABS and SQRT.

70. VOL calculates the volume of the potential sliding mass.

71. TRIANG determines the area of a triangle. It is called by VOL.

72. ELRED checks element coordinates on input and stores only those within a user-specified region. The number of elements, NEL, is re-defined as the number stored.

73. ENTRY determines specified points on circles, if there are more than one.

74. FOUREL determines the four elements in each quadrant surrounding a chord centre. It calls the library subroutine SQRT.

75. HAND adapts the data from a slope that faces right to be compatible with the rest of SLOPROB.

76. INPUT reads and writes all input data and calls subroutine MATCH. It also uses the library subroutines ABS and ATAN.

77. MATCH reads material numbers if required and assigns them to a given region.



78. MEET determines the meeting point of a circle and a line.

79. NORM determines the value of the cumulative distribution function of the normal distribution. It calls the library subroutines ABS and EXP.

80. PRESS determines the vertical distance from a chord centre to the limiting phreatic surfaces.

81. PROBRSF determines the probability of sliding on the trial surface and conventional factor of safety. It calls subroutines NORM and UP, and the library subroutines COS, SQRT and TAN.

82. TENCRC determines the meeting point of a circle and a tension crack. It calls the library subroutine SQRT.

83. UP determines the expected value of pore pressure.

#### Library Subroutines

84. ABS is the absolute value of an argument.

85. ATAN is the arctangent of an argument.

86. COS is cosine of an argument.

87. EXP is the function  $e^x$ , where  $x$  is an argument.

88. SIN is the sine of an argument.

89. SQRT is the square root of an argument.

90. TAN is the tangent of an argument.

#### Variables

91. The principal variable names and their meanings are as follows.

ALPHA is half the angle subtended at the centre of the slip circle by a chord.

ANINC is the angle subtended by the slip circle at its centre divided by the number of chords used to approximate the slip circle.

ARC is an array holding the coordinates of the centre of each chord used to approximate the slip circle, the inclination of the chord from the horizontal, the two normal stresses and the shear stress on the chord, and cohesion and values (mean and standard deviation) assigned to the chord centre.

ARCAN is the angle subtended by the slip circle at its centre.

ARCL is the length of each chord used to approximate the slip circle.

BETA is the angle between the tangent to the slip circle at the entry point and the horizontal.

BI is the term  $\sigma_i$  for the  $i^{\text{th}}$  chord.

BJ is the term  $\sigma_j$  for the  $j^{\text{th}}$  chord.

CI is the cohesion for the  $i^{\text{th}}$  chord.

COMPOS is a logical variable used to indicate sign convention of normal stresses on input.

COVUIJ is the co-variance of pore pressure on the  $i^{\text{th}}$  and  $j^{\text{th}}$  chords.

CPHI is an array holding cohesion and phi values for each material input.

CRACK is a logical variable used to denote the presence of a tension crack.

DATA is the namelist used to read in option controls and some data.

DELTA is the angle between a chord and the horizontal.

ENPT is an array holding the coordinates of specified points on the slip circle (if the circle is determined by a centre and a specified point, and if there is more than one specified point).

ES is the expected value of strength.

ETI is the expected value of  $\tan \phi$  for the  $i^{\text{th}}$  chord.

ETJ is the expected value of  $\tan \phi$  for the  $j^{\text{th}}$  chord.

EUI is the expected value of pore pressure on the  $i^{\text{th}}$  chord.

EUJ is the expected value of pore pressure on the  $j^{\text{th}}$  chord.

FFS is the final factor of safety.

FI is  $\phi$  for the  $i^{\text{th}}$  chord.

FJ is  $\phi$  for the  $j^{\text{th}}$  chord.

FLEFT is a logical variable used to indicate whether the slope faces left or right.

FMS is the lowest value of excess shear strength on a slip circle.

FMT is an array holding the format for reading finite element data.

FP is the probability of sliding for a particular cycle.

FPF is the highest probability of sliding.

FR is the radius of the critical circle.  
 FRX is the x-coordinate of the centre of the critical circle.  
 FRY is the y-coordinate of the centre of the critical circle.  
 FS is the factor of safety determined on a particular circle.  
 GAMMA is the unit weight of water.  
 HT is the slope height.  
 ICR is the unit number of the card reader.  
 INDEX is an array holding numbers of the four elements nearest a chord centre.  
 IPR is the unit number of the line printer.  
 ITR is the unit number of the device holding the file containing stress results from the finite element analysis.  
 LIST is an array holding numbers of elements within RDIST of the slip circle.  
 MARC is an array holding material numbers for the chords.  
 MAT is a material number.  
 MCH is the number of times a material number other than 1 is to be assigned to a slope region.  
 MTYPE is an array holding material numbers associated with each element.  
 NCDIV is the number of chords used to approximate the slip circle.  
 NCIRC is the number of slip circles for each specified point.  
 NCYC is the cycle number.  
 NEL is the number of elements in the original finite element analysis.  
 NFC is the cycle number of the critical circle.  
 NNEL is the reduced number of elements whose stresses are stored in SLOPROB.  
 NOPP is a logical variable to indicate inclusion of pore pressures.  
 NPT is the number of specified points through which circles pass (each point is used with each circle centre).  
 NP1, NP2 is the number of points defining the upper and lower phreatic surfaces.  
 NRX, NRY is the number of divisions in the x and y-directions of the region of circle centres.

OMIT is a logical variable used to bypass analysis, eg, if circles are outside the slope.  
 PAI is the height of upper phreatic surface above  $i^{\text{th}}$  chord.  
 PAJ is the height of upper phreatic surface above  $j^{\text{th}}$  chord.  
 PBI is the height of lower phreatic surface above  $i^{\text{th}}$  chord.  
 PBJ is the height of lower phreatic surface above  $j^{\text{th}}$  chord.  
 PNTEL is a logical variable used to control the print of data from the finite element analysis.  
 PRINT is a logical variable used to control the amount of printed output.  
 R is the radius of a slip circle.  
 RDIST is the 1/2-width of the annulus, whose centre is the slip circle, within which a search is made of elements to assign stresses to chords.  
 RHSPOS is a logical variable used to indicate sign convention of shear stress on input.  
 ROOT is the square root term in the solution to a quadratic equation.  
 RX is the x-coordinate of the slip circle centre.  
 RX1 is the lower x-coordinate of the region of circle centres.  
 RX2 is the upper x-coordinate of the region of circle centres.  
 RY is the y-coordinate of the slip circle centre.  
 RY1 is the lower y-value of the region of circle centres.  
 RY2 is the upper y-value of the region of circle centres.  
 SD is the standard deviation of strength.  
 SDCI is the standard deviation of cohesion for  $i^{\text{th}}$  chord.  
 SDFI is the standard deviation of  $\phi$  for  $i^{\text{th}}$  chord.  
 SDTANI is the standard deviation of  $\tan \phi$  for  $i^{\text{th}}$  chord.  
 SHEAR is the shear force on the slip circle.  
 SIG is an array holding stresses from the finite element analysis.  
 SLOPE is the mean slope angle.

TANG is a logical variable used to indicate that all slip circles touch a given line.

TEMP is a temporary term.

THETA is the angle between the tangent to the slip circle at the exit point and the horizontal.

TI,TJ,TIJ are integration limits for the probability distribution function of pore pressure.

TLINE is an array holding either coordinates of specified points on slip circles or the coordinates of two points defining a common tangent to slip circles.

VCI is the variance of cohesion for  $i^{\text{th}}$  chord.

VS is the variance of strength.

VTANI is the variance of  $\tan \phi$  for  $i^{\text{th}}$  chord.

VUI is the variance of pore pressure for the  $i^{\text{th}}$  chord.

VUTI is the variance of the term  $(u \tan \phi)$ .

X is the standardized normal variable for strength.

XLI, XLJ are the vertical distance between the upper and lower phreatic surfaces at the  $i^{\text{th}}$  and  $j^{\text{th}}$  chords.

XL1, XL2 are the maximum and minimum x-coordinates of a region whose finite element data is stored.

YL1, YL2 are the maximum and minimum y-coordinates of a region whose finite element data is stored.

XMS is the excess of shear resistance over disturbing force (may be negative).

XCREST is the x-coordinate of the slope crest.

XTC is the x-coordinate of the bottom of a tension crack.

XTOE is the x-coordinate of the toe of the slope.

XY is an array holding the coordinates of element centres.

XYC is an array holding the coordinates of the entry point and exit point of the slip circle.

X1, Y1 are the coordinates of the entry point of the critical circle.

X2, Y2 are the coordinates of the exit point of the critical circle.

V is the volume of the potential sliding mass.

YCREST is the coordinate of the slope crest.

YTC is the y-coordinate of the bottom of a tension crack.

YTOE is the y-coordinate of the toe of the slope.

#### Listing

92. A complete Fortran listing of SLOPROB will be supplied on request.

#### Example and Control Cards for CDC 6400

93. Figure A-8 shows a simple slope analysed by SLOPROB. The slope has a varying phreatic surface. Figure A-9 shows the control cards and input data required to run SLOPROB on the CDC 6400 machine. In this example, the results from the prior finite element analysis are stored on tape, and the file is given the logical name TAPE8. In this particular example, the order of the finite element data is: stresses followed by element coordinates, and so the relevant card (INPUT.72) is changed using the CDC Update operation. One material only is used in this example. The upper phreatic surface is defined by 5 points and the lower by 6 points.

94. The printed output for this problem is shown in Figs A-10(a) to A-10(e). Twelve circles only were examined in this example.

#### Computer System

95. SLOPROB was developed on a CDC 6400 machine using SCOPE level 3.4. The CDC 6400 machine uses a 60 bit word with a core cycle time of 1000 nano-seconds.

96. Peripheral equipment used was a CDC 224-2 card reader, a CDC 222 line printer and a CDC 841 disk drive (for the file of finite element results).

#### Storage and Time Requirements

97. SLOPROB requires approximately 16000 decimal words to run under SCOPE 3.4 on the CDC 6400. The time required depends on NEL, the number of elements in the original finite element analysis, on NNEL, the reduced number of elements from which data is stored, on RDIST the region around each circle that is searched, on NCCY the number of

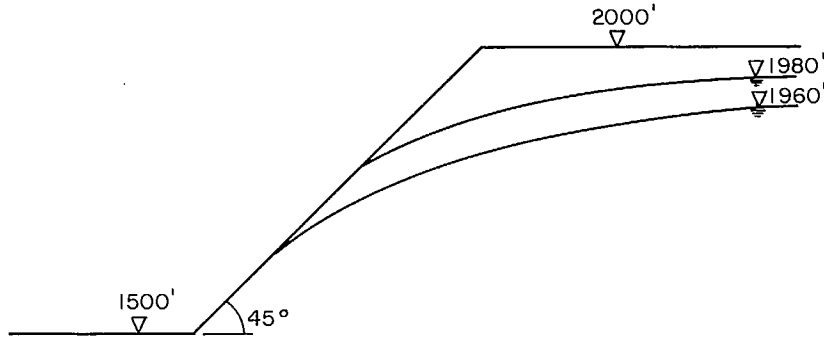

Fig A-8 Slope used for the example demonstrating the use of SLOPROB.

```

H4198,CM60000,T50,P2,MT1.      job cards      SLOPROBU
ACCOUNT,*****.SLOPROBU
ATTACH,OLDPL,SLOPROBU,IO=MRL,MR=1.  source deck file
UPDATE(F,L=A1)                   update option (CDC only)
FTN(I,L=0)                         fortran compile without list
REQUEST,SAPSLEP,MF,E. FR3X05      finite element data file
LABEL,TAPE8,R,L=SAPOUTSLOP500,O=HY,M=SAPSLEP,P=5.
LGO.                                load job and go
7/8/9  CARD (MULTIPLE PUNCH IN COLUMN 1)
*IDENT MOD                         cards for CDC update option
*DELETE INPUT.73                   delete card INPUT .73 and substitute following card
      READ(ITR,FMT)S1,S2,S3,X,Y
7/8/9  CARD (MULTIPLE PUNCH IN COLUMN 1)
$DATA                               beginning of namelist data
NEL=1000,P=INT=.TRUE.,COMPOS=.FALSE.,NP1=5,NP2=6,
NRX=4,NPY=3,
$  end of namelist data (names not given here assume program default values)
SLOPROB ANALYSIS OF 45 SLOPE        title
(5E13.7)                            format of finite element data
450.      1400.0      1400.      2000.      100.      region of finite elements
500.0     1500.0     1000.0     2000.0     toe and crest coordinates
          11440.0     432.0      35.0      5.0      material properties
100.0     600.0      2000.0     2400.0     500.0     1500.0 definition of circles
500.0     1500.0
755.0     1758.0
900.0     1836.0
1050.0    1900.0
1450.0    1980.0
500.0     1500.0      beginning of cards for lower phreatic surface
660.0     1660.0
810.0     1750.0
1000.0    1840.0
1215.0    1920.0
1440.0    1960.0
7/8/9  CARD (MULTIPLE PUNCH IN COLUMN 1)
6/7/8/9 CARD (MULTIPLE PUNCH IN COLUMN 1 - DENOTING END OF JOB)

```

Fig A-9 Control cards and input data for SLOPROB example (for this example, the order of data from the finite element analysis is changed by altering card INPUT.72).

## SLOPE STABILITY ANALYSIS

PROBABILITY OF SLIDING ANALYSIS OF A SLOPE USING SLIP CIRCLES AND STRESSES DETERMINED BY FINITE ELEMENT ANALYSIS  
 SLOPROB ANALYSIS OF A 45 DEGREE SLOPE

```

$DATA
COMPDS = F.
CRACK   = F.
FLEFT  = T.
GAMMA  = .624E+02.
ICR    = 5.
IPR    = 6.
ITR    = 8.
MCH    = 0.
NCDIV  = 30.
NEL    = 1000.
NMAT   = 1.
NP1    = 5.
NP2    = 6.
NPT    = 5.
NRX    = 4.
NRY    = 3.
PNTEL  = F.
PRINT  = T.
RHSPDS = T.
TANG   = F.
$END

```

FORMAT FOR READING FINITE ELEMENT DATA IS (5E13.7)

Fig A-10(a) Heading output identifying the case and NAMELIST DATA default values indicating: tension is positive, there are no tension cracks, the slope faces left, the density of water is 62.4, the card reader is unit number 5, the line printer is unit number 6, the device carrying the finite element data is number 8, there are 0 regions requiring a different material number, ie with different properties, 20 chords comprise the slip circle, 1000 elements comprise the finite element model, there is 1 material, 5 points define the upper phreatic line, 6 points define the lower phreatic line, 5 points could be input through which the slip circle must pass, the grid for the centres of the trial circles has 4 divisions in the x-direction, and 3 in the y-direction, the results of the finite element analysis are not to be printed, other data is to be printed (ie NAMELIST DATA), the shear stress sign convention is as shown in Fig 14, the slip circles are not defined by a line to which they would have to be tangent.

```

ONLY ELEMENTS IN FOLLOWING REGION STORED
  XMIN      XMAX      YMIN      YMAX
450.0000 1400.0000 1400.0000 2000.0000

ONLY ELEMENTS WITHIN 100.0000 OF SLIP CIRCLE WILL BE SEARCHED

CO-ORDS OF TOE ARE 500.00 1500.00 CO-ORDS OF CREST ARE 1000.00 2000.00

MEAN SLOPE ANGLE IS 45.00 SLOPE HEIGHT IS 500.00

MATERIAL PROPERTIES
MATERIAL MEAN COHESION S.D. OF COHESION MEAN PHI S.O. OF PHI
1 1440.00 432.00 35.00 5.00

REGION OF CIRCLE CENTRES
  XMIN      XMAX      YMIN      YMAX      X-DIVS  Y-DIVS
100.0000 600.0000 2000.0000 2400.0000 4 3
TRIAL CIRCLES PER ENTRY POINT ARE 12 NUMBER OF CHORDS IS 30

CIRCLES PASS THROUGH 500.0000 1500.0000

UPPER PHREATIC SURFACE IS DEFINED BY 5 POINTS
LOWER PHREATIC SURFACE IS DEFINED BY 6 POINTS
UPPER SURFACE IS
  X Y X Y X Y X Y X Y X Y
500.00 1500.00 755.00 1758.00 900.00 1836.00 1050.00 1900.00 1450.00 1980.00
LOWER SURFACE IS
  X Y X Y X Y X Y X Y X Y
500.00 1500.00 660.00 1660.00 810.00 1750.00 1000.00 1840.00 1215.00 1920.00 1440.00 1960.00

NORMAL STRESS IS TENSION POSITIVE - THIS CONVENTION IS REVERSED INTERNALLY IN THE PROGRAM
SHEAR STRESS IS POSITIVE IF IN INCREASING Y DIRECTION ON R.H.S. OF ELEMENT
SLOPE FACES LEFT - IN DIRECTION OF DECREASING X

```

Fig A-10(b) The technical input data: finite element stresses and coordinates are stored only for the region within  $450 < x < 1400$  ft and  $400 < y < 1000$  ft, for interpolating to obtain stresses on the slip surface elements within 100 ft on either side of the slip circle are used, the coordinates of the toe are  $x = 500$  ft,  $y = 500$  ft and of the crest are  $x = 1000$  ft,  $y = 1000$  ft, the slope angle is  $45^\circ$  and the height is 500 ft, for Material No. 1 the mean cohesion is 1440 psf with a standard deviation of 432 psf and the mean angle of friction is  $35^\circ$  with a standard deviation of  $5^\circ$ , the grid of circle centres covers the area  $100 < x < 600$  ft and  $1000 < y < 1400$  ft with 4 divisions in the x-direction and 3 divisions in the y-direction, hence the number of trial circles is 12 and each circle is made up of 20 chords, each circle must pass through the point  $x = 500$  ft,  $y = 500$  ft (the toe of the slope), the upper phreatic surface is defined by 5 points, the lower is defined by 6 points, the x and y-coordinates of the 5 points on the upper surface are given, the 6 points on the lower surface are given.

INTERMEDIATE RESULTS										
CYCLE	CENTRE CO-ORDS	RADIUS	ENTRY POINT	EXIT POINT	SAFETY FACTOR	SLIDING PROB. %	EXCFSS SH. STRENGTH	SLI OF VOL. UNIT WITH	COMMENTS	
1	100.00 2000.00	640.31	500.00 1500.00	600.00 1600.00					INHERENTLY STABLE - NO RESULT EXIT POINT IS AFLOW CREST	
2	100.00 2200.00	806.23	500.00 1500.00	800.00 1800.00	1.47	LT 1.0	.4236E+06	.8064E+04	EXIT POINT IS AFLOW CREST	
3	100.00 2400.00	984.89	500.00 1500.00	1000.00 2000.00	1.02	43.23	.7044E+05	.3116E+05		
4	266.67 2000.00	551.76	500.00 1500.00	766.67 1766.67	1.52	LT 1.0	.4470E+06	.8404E+04	EXIT POINT IS BELOW CREST	
5	266.67 2200.00	737.86	500.00 1500.00	966.67 1966.67	1.03	41.50	.9706E+05	.3465E+05	EXIT POINT IS AFLOW CREST	
6	266.67 2400.00	929.76	500.00 1500.00	1105.98 2000.00	.93	74.42	-.5506E+06	.7254E+05		
7	433.33 2000.00	504.42	500.00 1500.00	933.33 1933.33	1.12	18.86	.5230E+06	.4334E+05	EXIT POINT IS AFLOW CREST	
8	433.33 2200.00	703.17	500.00 1500.00	1107.46 2000.00	.97	58.68	-.2349E+06	.9115E+05		
9	433.33 2400.00	902.47	500.00 1500.00	1242.31 2000.00	1.04	38.49	.4433E+06	.1324E+06		
10	600.00 2000.00	509.90	500.00 1500.00	1109.90 2000.00	1.14	17.18	.1485E+07	.1299E+06		
11	600.00 2200.00	707.11	500.00 1500.00	1278.23 2000.00	1.16	14.18	.2181E+07	.1787E+06		
12	600.00 2400.00	905.54	500.00 1500.00	1412.40 2000.00	1.26	5.56	.3950E+07	.2193E+06		

Fig A-10(c) The results for each of the 12 trial circles giving the x and y-coordinates of the centre of the circle, its radius, the entry point (the toe of the slope in each case), the x and y-coordinates of the exit point of the slide surface, the safety factor, the probability of instability if that circle were to define the slide, the excessive of shear strength over shear force using mean values, and observations where the slip surface exits on the face of the slope instead of in the crest.

FINAL RESULT  
\*\*\*\*\*

CYCLE 6 HAS HIGHEST SLIDING PROBABILITY OF 74.42% WITH APPROX. VOL. OF .7254E+05 PER UNIT WIDTH  
 CYCLE 6 HAS LOWEST FACTOR OF SAFETY DF .93 WITH APPROX. VOL. OF .7254E+05 PER UNIT WIDTH  
 CYCLE 6 HAS LOWEST EXCESS SHEAR STRENGTH OF -.5506E+06 WITH APPROX VOL. OF .7254E+05 PER UNIT WIDTH

Fig A-10(d) Selection of the most critical circle of the 12 trials.

STATISTICS				
CYCLE	RED. ELS.	CYCLE TIME	PROB. TIME	
1	51	.13	.06	
2	94	.15	.07	
3	149	.17	.07	
4	85	.15	.07	
5	150	.19	.07	
5	201	.21	.06	
7	159	.19	.07	
8	202	.31	.09	
9	217	.25	.08	
10	201	.20	.07	
11	223	.24	.08	
12	221	.27	.11	

TOTAL ELEMENTS.....	1000
STORED ELEMENTS.....	420
TIME FOR 12 CYCLES.....	2.45
INPUT TIME.....	1.46
TOTAL TIME.....	3.92

Fig A-10(e) Statistics for each trial circle: the number of finite elements adjacent to the slip circle (ie within 100 ft ), the time to calculate the safety factor, the time to calculate the probability of instability. The total finite elements is 1000 of which only 420 fell within the defined area of interest for the slip circle analysis. The total run time for the 12 circles was 3.87 sec.

cycles and on NCDIV the number of chords.

98. For typical problems with NCDIV = 40, NEL = 1000, NNEL = 400; about five trial circles can be analysed per second of central processor time.

Operator Action

99. No special operator action is required for SLOPROB. The program must be re-run on error.

APPENDIX B

USER'S MANUAL FOR SAP2D, A FINITE ELEMENT PROGRAM



## PROGRAM IDENTIFICATION

Program Title

2D Linear Elastic Finite Programs

Program Name

SAP2D

Author

Neil Toews and Yang Yu

Organization

Mining Research Laboratories, CANMET, Department of Energy, Mines and Resources, 555 Booth Street, Ottawa, K1A 0G1, Canada.

Date of First Documentation

1974

Source Language

Fortran IV (CDC CYBER 74, Scope 3.4)

Availability

Tape will be supplied on application to the Mining Research Laboratories, CANMET, Department of Energy Mines and Resources, 555 Booth St., Ottawa, K1A 0G1, Canada.

Disclaimer

Neither the authors nor the Mining Research Laboratories can accept responsibility for the correctness of the results obtained from this computer program.

## INTRODUCTION

1. The finite element (FE) method has become a very useful tool for analyzing mining structures. The models used in rock mechanics tend to be large. Thus data preparation, without a mesh-generating system, is a time-consuming process and is prone to error.

2. SAP2D, a modified version of Wilson's SAP program (B-1), is a static linear elastic program for the analysis of two-dimensional models (plane and axisymmetric). A two-dimensional mesh-generating program, MSHGEN, originally developed to automate WILAX input preparation (B-2), has been modified and incorporated with SAP2D. This program closely follows the concepts and terminology introduced by Zienkiewicz and Phillips (B-3).

3. Two companion programs, MSHPLT and SAP2DC, are also described. MSHPLT is a program for plotting the finite element mesh produced by MSHGEN so that a visual inspection of the generated mesh can be carried out. SAP2DC performs the final conversion of the MSHGEN output to the format demanded by the SAP2D as well as inputting material properties, concentrated forces, etc, to produce an input file for SAP2D. This system can be adapted, with some minor modification, to most finite element programs.

4. Experience with this SAP2D data preparation system, at least for the type of problems encountered, has been good. Meshes that formerly took several weeks of work to prepare and check can now often be finished in a day or two.

5. These programs have been developed on the CDC 6400 and CYBER 74 under the operating system scope 3.4. The programs are fairly machine independent and should run on most machines with relatively few modifications. However, the printer-plot facility used in MSHGEN involves character manipulation and is therefore machine dependent. The printer-plot is performed by a separate group of subroutines in MSHGEN and can be removed merely by deleting references to these routines. The finite element program SAP2D uses only single precision. This would perhaps have to be modified if a computer with short word length

were used.

6. The hardware requirements to run the SAP2D system of programs described in this manual are as follows:

- card reader
- printer
- 9 scratch files
- 1 results file (SAP2D stores results here for future graphical display).

An average size for an open-pit finite element model would be:

Number of elements (NUMEL) = 2000

Number of nodal points (NUMNP) = 2100

Half-bandwidth of stiffness matrix (MBAND) = 90.

Such a problem on a CYBER 74 computer could be handled with a central memory of less than 43,000 single precision words. The cost would be less than \$90 (in 1975).

7. The final section of the report describes an example. In particular, the advantages of using the plotter for the graphical representation of stresses and displacements is shown.

## MSHGEN

### General

8. MSHGEN is the mesh generator that produces finite element output data for SAP2D. This generator is very similar to the one described in references B-1 and B-2. The chief differences are: there is more extensive checking of input error, including a printer-plot for visual inspection, and linearly varying pressures can now be generated on element sides.

### Concepts and Terminology

9. This section introduces the basic concepts involved in MSHGEN as well as the terminology needed to understand the discussion of the program.

10. Consider the continuous quadratic mapping defined by

$$X = \sum_{i=1}^8 X_i N_i (\xi, \eta), \quad Y = \sum_{i=1}^8 Y_i N_i (\xi, \nu).$$

Here  $N_1 (\xi, \nu)$ ,  $N_2 (\xi, x)$  .....  $N_8 (\xi, \nu)$

are eight interpolating functions. (For typing convenience the notation (EPS, ETA) will be used for  $(\xi, \eta)$  in much of this report).

11. The order of the interpolating functions corresponds to the key zone numbering in Fig 1.

$$N1 = -0.25 (1 - \xi) (1 - \eta) (\xi + \eta + 1)$$

$$N2 = -0.25 (1 + \xi) (1 - \eta) (-\xi + \eta + 1)$$

$$N3 = -0.25 (1 + \xi) (1 + \eta) (-\xi - \eta + 1)$$

$$N4 = -0.25 (1 - \xi) (1 + \eta) (\xi - \eta + 1)$$

$$N5 = 0.5 (1 + \xi) (1 - \xi) (1 - \eta)$$

$$N6 = 0.5 (1 + \xi) (1 + \eta) (1 - \eta)$$

$$N7 = 0.5 (1 + \xi) (1 - \xi) (1 + \eta)$$

$$N8 = 0.5 (1 - \xi) (1 + \eta) (1 - \eta)$$

12. This mapping, under certain restrictions, defines a one-to-one correspondence between points in a 2 by 2 square, called a key diagram zone (key zone), and points in a curvilinear quadrilateral with possibly parabolic sides, called a model diagram zone (model zone) (see Fig 1). This mapping is completely defined when the coordinates of the eight points  $(X1, Y1)$ ,  $(X2, Y2)$ , .....  $(X8, Y8)$ , as shown on the model zone in Fig B-1, are given. These points are called the specified points. Points 1 to 4 are the corner specified points and points 5 to 8 are the intermediate specified points.

13. If the span of the key zone in the EPS direction is subdivided, for example into 4 sub-intervals and the ETA span is divided into 3 sub-intervals then the key diagram zone is subdivided into rectangles as shown in Fig B-2(a). The 20 points defined by this subdivision (Fig B-2(a)) are mapped onto the 20 points (nodal points) on the model zone (Fig B-2(b)). If these points are connected by straight lines (Fig B-2(c)) then a finite element discretization of the model zone is produced. By increasing the number of subdivisions it is possible to approximate the parabolic sides of the model zone as closely as desired (Fig B-2(d)).

14. Different mesh grading can be achieved by proper choice of the intermediate specified points. Figure B-3(a) shows the discretization of a straight-sided quadrilateral when mid-point intermediate points are used. Figure B-3(b) shows an example of the mesh grading that can be

achieved with a different choice of intermediate specified points but with the same number of subdivisions.

15.  $\alpha$  is defined as the fraction of the side length at which the intermediate point is selected. Thus Fig B-3(a) has  $\alpha = 0.5$  on all 4 sides whereas Fig B-3(b) has  $\alpha$ 's as shown. It can be shown that the following restriction,  $0.25 < \alpha < 0.75$ , must hold if the mapping is to remain a one-to-one correspondence. Figure B-4 shows for a one-dimensional case, the grading that is achieved when  $\alpha$  is varied from 0.5 to 0.25 in steps of 0.05. Note that  $\alpha = 0.25$  still gives a valid discretization. For sufficiently coarse subdivisions even larger values of  $\alpha$  could be used. The explanation is that, although the mapping may be nonunique (ie certain points of key zone map outside the model zone), as long as none of the 'nodal points' selected on the key zone belong to this nonunique area then an acceptable discretization could still result.

16. A further restriction on the model zone is that no interior angle of a model zone can be greater than 180 degrees. Thus a model zone as shown in Fig B-5(a) is illegal. Triangular zones (zones with interior angles equal 180 degrees) are, however, possible. Figure B-5(b) gives an example of a discretization of such a zone.

17. Most models for which we want discretization are considerably more complex than a curvilinear quadrilateral. The assumption is made in MSHGEN that the given model can be subdivided into a number (hopefully few) of interconnected model zones and that a corresponding key diagram, made up of key zones, can be set up. The procedure for doing this will be fully described in the next section.

#### Input Preparation

18. It is recommended that the following set of procedures be followed prior to preparing MSHGEN input data. Throughout this section it will be assumed that the no IDENTIFICATION option of MSHGEN (this is a feature that will be discussed later) is in effect. To illustrate the recommended procedure a simple example

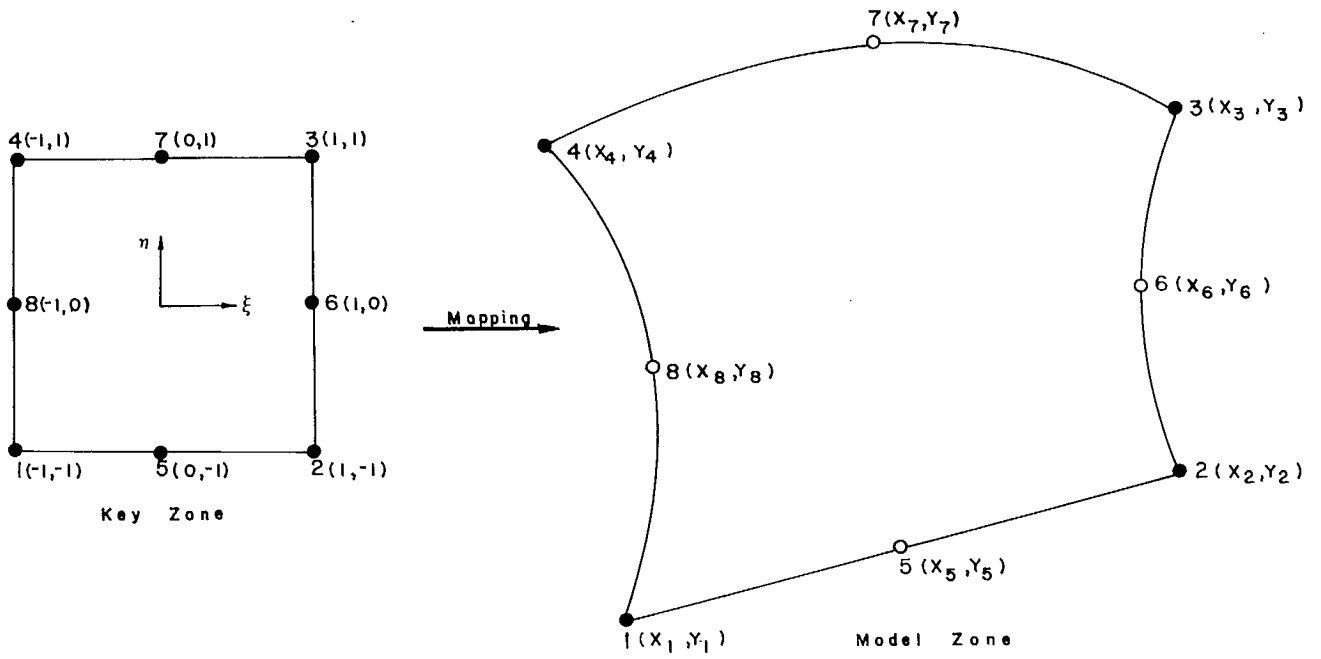

Fig B-1 - Fundamental mapping of key zone onto model zone.

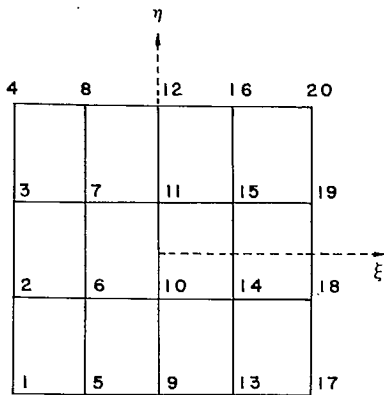

Fig B-2(a) - Subdivision of key zone.

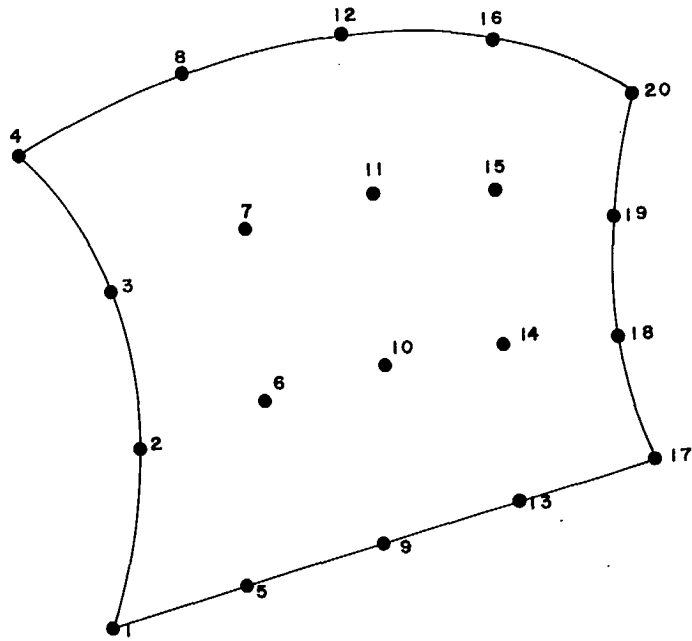

Fig B-2(b) - Nodal points in model zone.

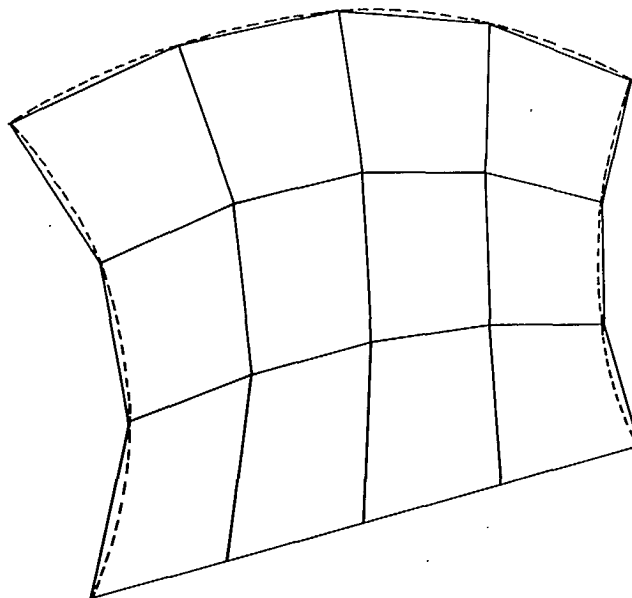

Fig B-2(c) - Discretization of model zone.

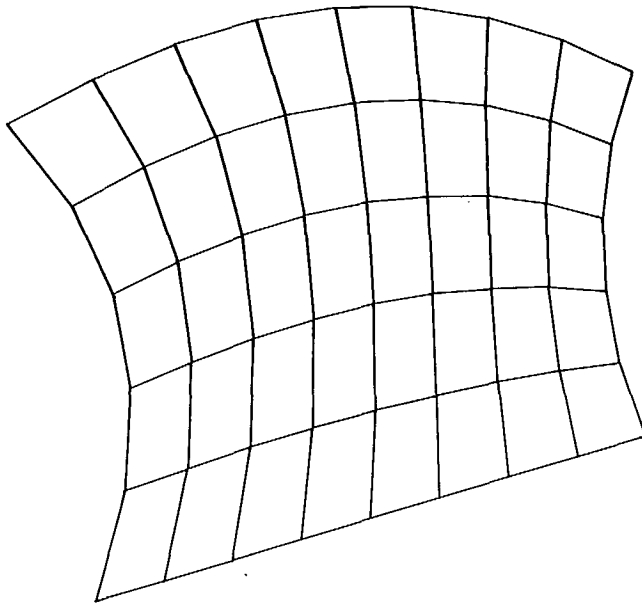

Fig B-2(d) - Refined finite element discretization of model zone.

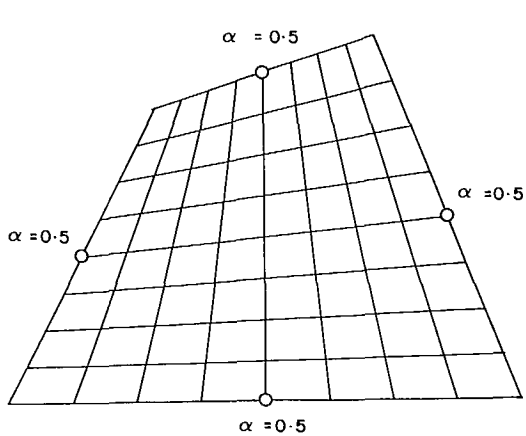

Fig B-3(a) - Mesh grading with mid-point intermediate points.

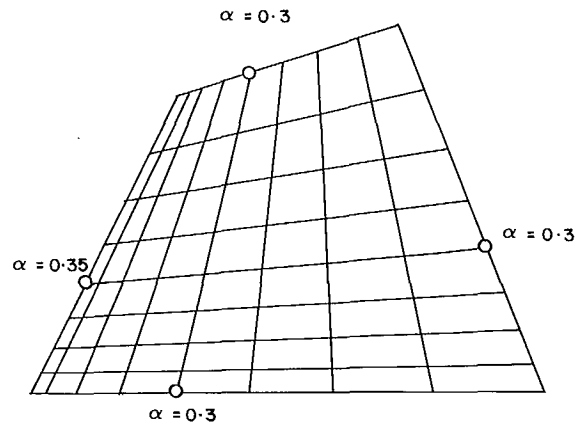

Fig B-3(b) - Mesh grading with non mid-point intermediate points.

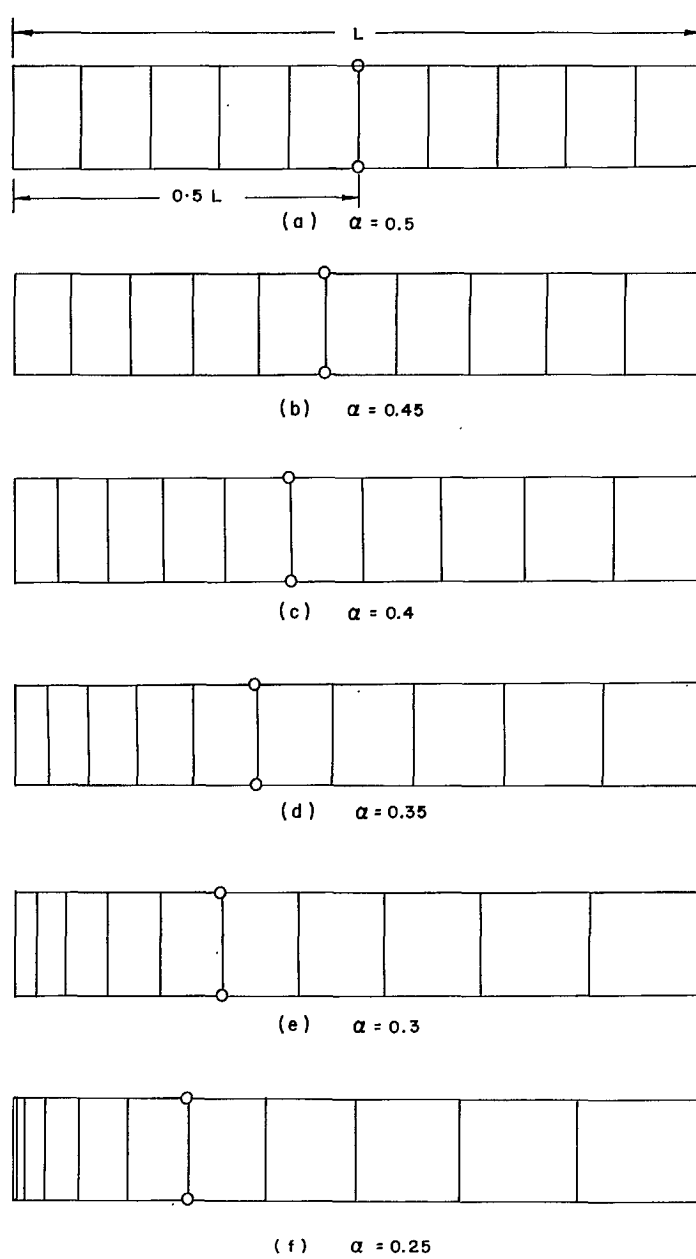

Fig B-4 - Grading achieved by different intermediate points.

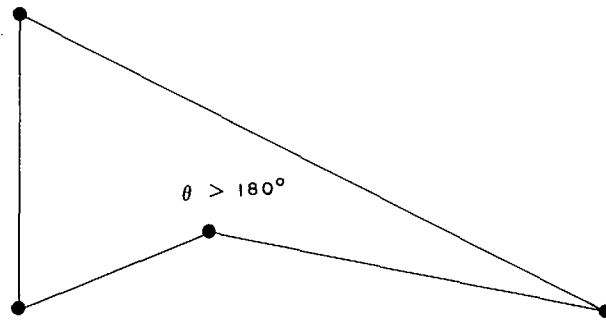

Fig B-5(a) - Model zone with interior angle greater than  $180^\circ$  is illegal.

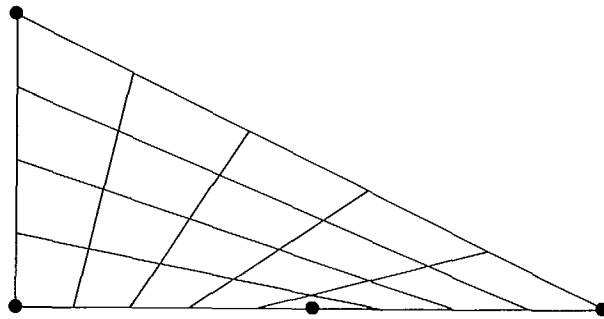

Fig B-5(b) - Triangular model zone is legal.



(Fig B-6(a)) will be used. More realistic models, with less detail are shown in Fig B-7 and B-8.

19. Step 1. First, a sketch of the structure to be analyzed should be drawn to some appropriate scale (Fig B-6(a)).

20. Step 2. Subdivision of structure into model zones is the most critical step in the procedure if a well-graded discretization is to be achieved. Experience with the program and some ingenuity can pay large dividends here. The object is to minimize the number of zones subject to the following constraints.

- a. Zones must be sufficiently small that an adequate representation of model curvilinear boundaries can be achieved.
- b. Zones must be selected to achieve the mesh grading appropriate for the model without generating an excessive number of nodal points and elements.
- c. A given zone must be homogeneous with respect to material properties, although distinct zones can have identical properties.
- d. If the 'cut' option is used then a given zone must be homogeneous as far as 'cut number' is concerned. This version of SAP2D allows a progressive excavation sequence to be modelled without reinputting all the data for each excavation (or subproblem in SAP2D terminology). The number of the subproblem in which a given element is eliminated is called the cut number of that element.
- e. Any zone corner node interior to the model must be the corner node of exactly 4 zones.
- f. Interior angles of zones must not be greater than 180 degrees. However, as indicated in the last section triangular zones are possible.
- g. To minimize the amount of hand modification to be performed later, keep in mind the procedure used by MSHGEN in assigning boundary condition codes to nodal points and select the zone subdivision accordingly.
- h. Pressures on zone sides can vary at most linearly.

21. Figure B-6(b) gives a possible zone subdivision of the demonstration model.

22. Step 3. Specified nodal points are

assigned. Each zone is identified and its connectivity with other zones established by these points. Numbering must be in a natural integer sequence (1 to NSPNP, where NSPNP is the total number of specified points). The four corner nodes of the model zones must always be specified. However, when a zone side is a straight line, and if no grading is required, then the intermediate point is generated by the program and need not be specified. There is no restriction on what integer (1 to NSPNP) is associated with a given point. In specifying intermediate points for grading, remember the restrictions on  $\alpha$  given in the last section. Mesh grading with curvilinear zones is more difficult, and the restriction on the intermediate points is less clear. Highly distorted curvilinear zones sometimes give trouble when grading is attempted. In this case it is probably better to use smaller zones. Figure B-6(c) shows the specified points selected for the illustrative example.

23. Step 4. A key diagram is produced. With each model diagram zone we associate a key diagram zone in such a way that the assumed mapping maps the key zone to the model zone. A key diagram is made up of the associated key zones in such a way that model zone connectivity is maintained.

24. When this has been done it is very important that the key diagram have a sufficient number of zones added to it to form a complete rectangle. The key zones that are not associated with any model zone are called void zones. Completion of the key diagram to form a rectangle and the resulting regular structure makes the programming relatively straightforward. Figure B-6(d) gives the key diagram for the example.

25. Step 5. Selection of global (EPS, ETA) key diagram reference system should be carried out next. There are two possible right handed coordinates reference systems. (a) Take the origin at lower left hand corner of key diagram rectangle. EPS is then horizontal to the right and ETA vertical upward (Fig B-6(e)). (b) Take the origin at upper left hand corner of key diagram. EPS is then vertically down and ETA horizontal to the right (Fig B-6(f)). Zones are

always numbered in the manner shown in Fig B-6(e) and B-6(f). Note that all zones, including void zones, are numbered.

26. (a) or (b) is selected depending on which gives the smaller maximum bandwidth ( $2 \times \text{node difference} + 2$ ) for the resulting stiffness matrix.

27. MSHGEN always generates finite element nodal numbers in the EPS direction. Once the number of subintervals into which each span is to be subdivided is selected, the calculation of the bandwidths can proceed.

28. Figure B-6(h) and B-6(i) show the discretization, as well as resulting maximum bandwidth, for the key diagrams Fig B-6(e) and B-6(f) respectively. Thus Fig B-6(e) is the appropriate choice if bandwidth is to be minimized.

29. Step 6. Transfer the nonvoid key zone numbers to the associated model zones of the model diagram (Fig B6(g)).

30. This completes the preliminary data preparation phase.

#### Boundary Condition Code

31. SAP2D requires that displacement constraints be assigned to all nodal points. This is done by specifying an appropriate integer value called the boundary condition code.

32. The following describes the procedure adopted in MSHGEN to select values for the condition codes. In MSHGEN the condition codes of all specified points are input and stored in an array called NCODSP. However, only the condition codes assigned to the corner specified points are used by MSHGEN.

33. The procedure is as follows:

- a. Corner zone specified points become FE nodal points. The condition codes of these points are unchanged.
- b. On the boundary of a zone the condition code of intermediate generated FE nodal points is taken to be the minimum of the condition codes of the corner points of that zone (or those zones).
- c. All generated FE nodal points in the interior of a zone are given a condition code of zero,

ie, treated as completely unconstrained.

34. The above choice of procedure although somewhat arbitrary has worked well. If condition codes are not as desired, the user can follow one of the following procedures.

35. If there are many nodal points with incorrect conditions codes, it is probably best either (a) to rezone the model with the MSHGEN condition code generating procedure in mind, or (b) to modify MSHGEN to produce the correct FE code.

36. If, however, only a few points need changing (the more usual case) then this is probably best done by hand modification of SAP2DC output.

37. Linearly varying pressure can be assigned to zone sides. These pressures are then generated for the elements produced.

#### Identification Facility

38. The identification capacity, although built into MSHGEN, has been little used. The discussion given will be very brief and illustrated by only one example.

39. Using the procedure already introduced it would be difficult, if not impossible, to obtain a properly graded mesh for a region with multiple connections (say a plate, with one or more openings). Figure B-9 shows such an example. This problem can be alleviated by allowing the user to draw key zones in such a way that model zone connectivity is not necessarily maintained. Thus the same specified points would occur more than once in the key diagram as shown in the example (Fig B-9).

40. Note that the problem of minimizing bandwidth is now different than for the simply connected no-identification procedure discussed previously. Thus changing the (EPS, ETA) global system in the example would increase the maximum bandwidth from 192 to 1976.

#### MSHGEN Input

- a. Card #1 Title Card  
 FORMAT(8A10)  
 READ , HDING

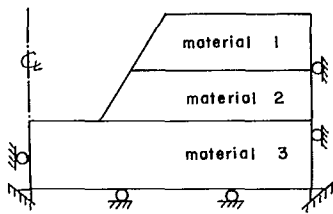

Fig B-6(a) - Model-hypothetical slope with gravity loading.

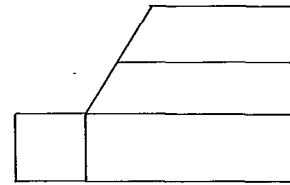

Fig B-6(b) - Possible zone division of model.

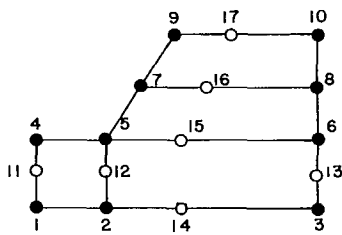

Fig B-6(c) - Assigning specified points.

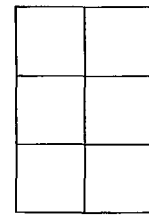

Fig B-6(d) - Associated key diagram.

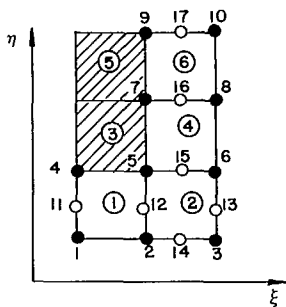

Fig B-6(e) - One possible choice of (EPS, ETA) with associated zone numbers.

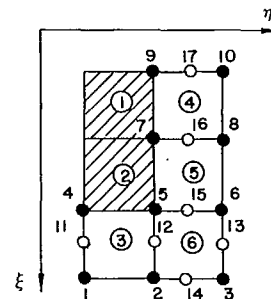
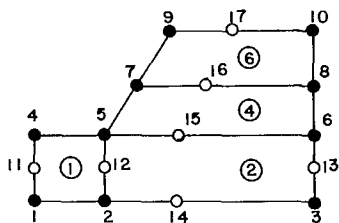

Fig B-6(f) - Second choice of (EPS, ETA) with associated zone numbers.



- corner points
- Intermediate points
- ② zone numbers
- ▨ void zone

Fig B-6(g) - Zone numbers transferred to model diagram.

Number of nodal points = 423  
 Number of elements = 380  
 Max. nodal point diff. = 22

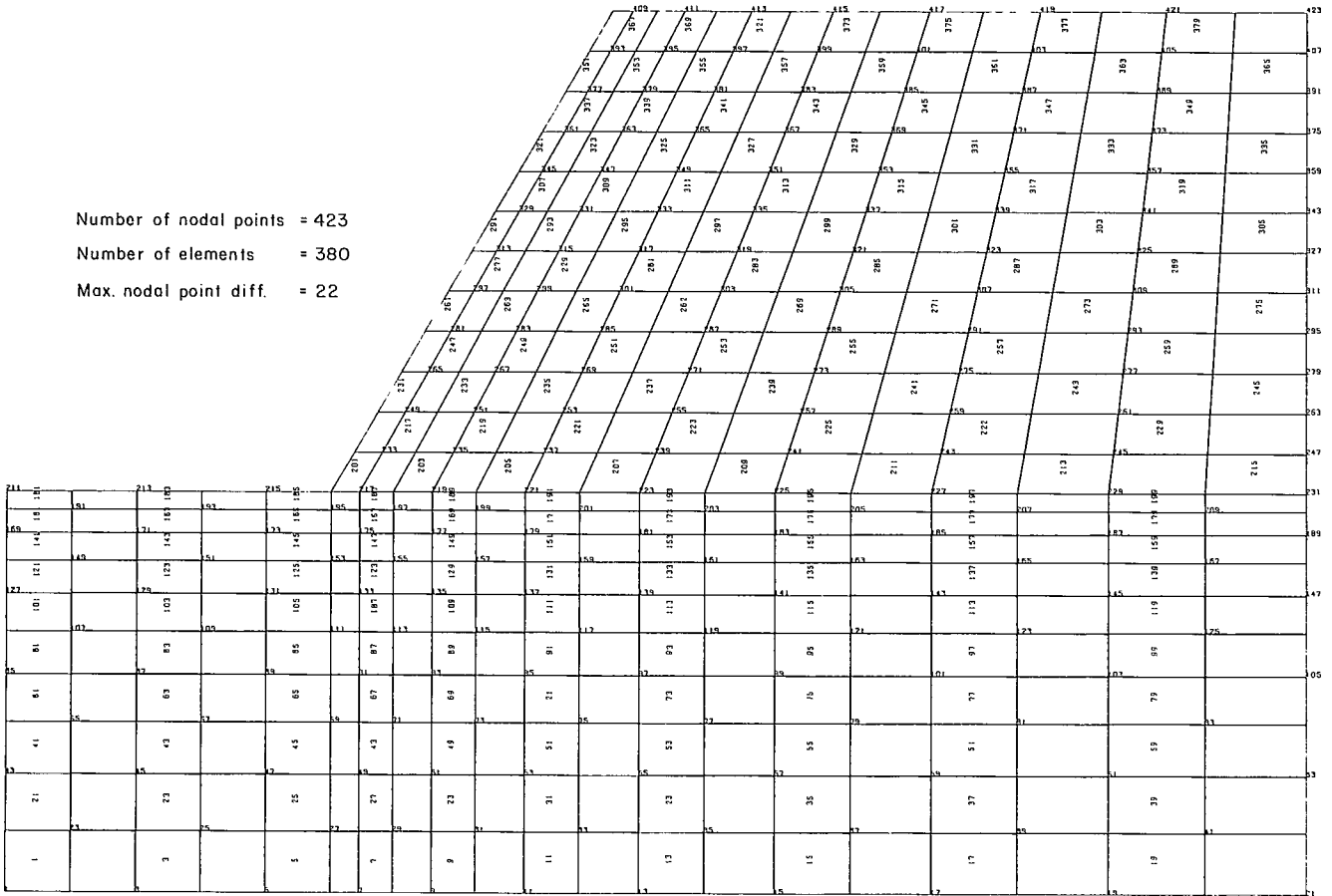

Fig B-6(h) - Finite element discretization associated with Fig B-6(e).

Number of nodal points = 423  
 Number of elements = 380  
 Max. nodal point diff. = 24

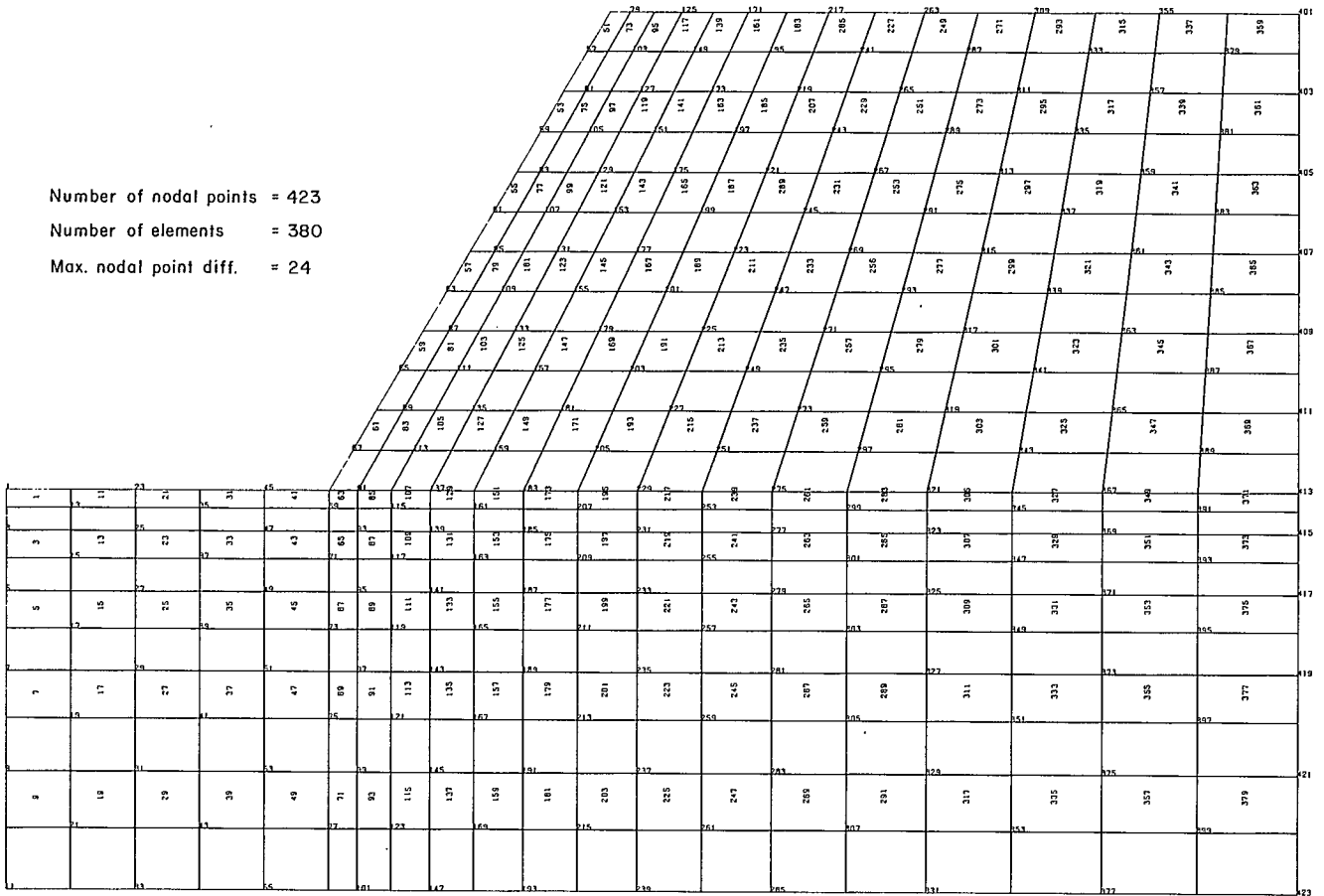
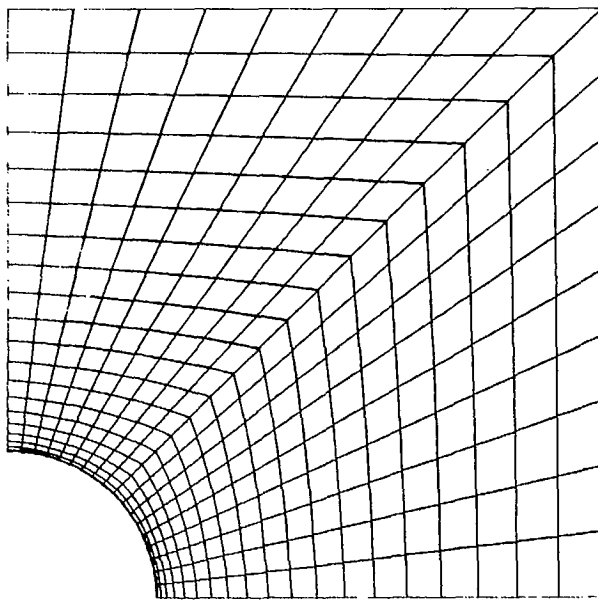
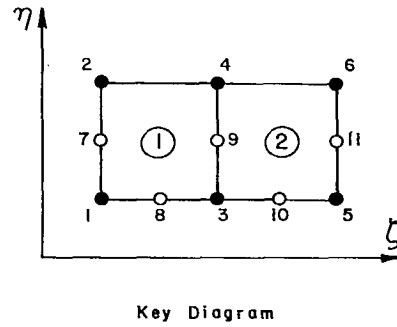
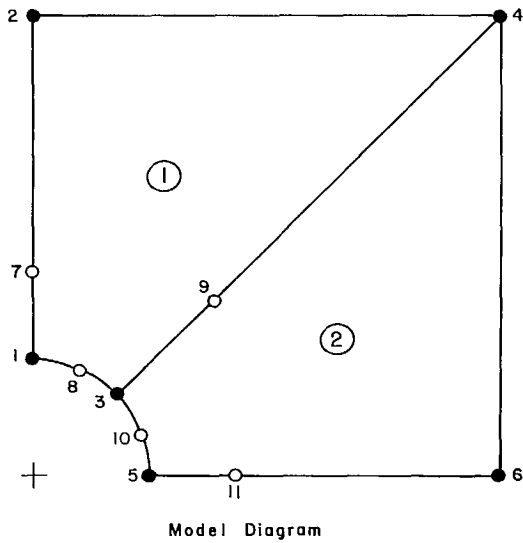







Fig B-6(i) - Finite element discretization associated with Fig B-6(f).



- Corner Points
- Intermediate Points

Fig B-7 - Plate with a circular opening.

SYMBOL	MATERIAL	SYMBOL	MATERIAL
1 	Andesite / Diorite	4 	Basic Dikes (H/W Shear Zone)
2 	Rhyolite	5 	Serquanite (Altered Rhyolite)
3 	Ore		

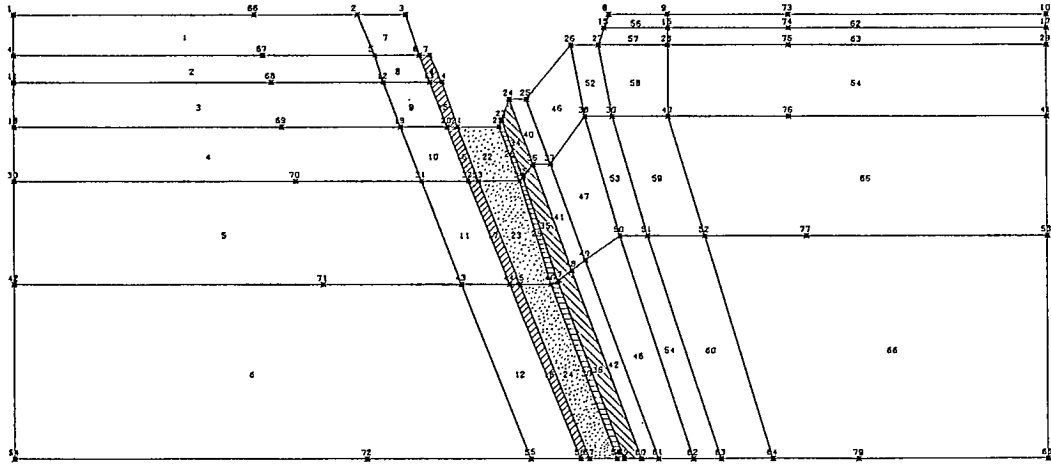

Fig B-8(a) - Model diagram - simulation of an open pit mine.

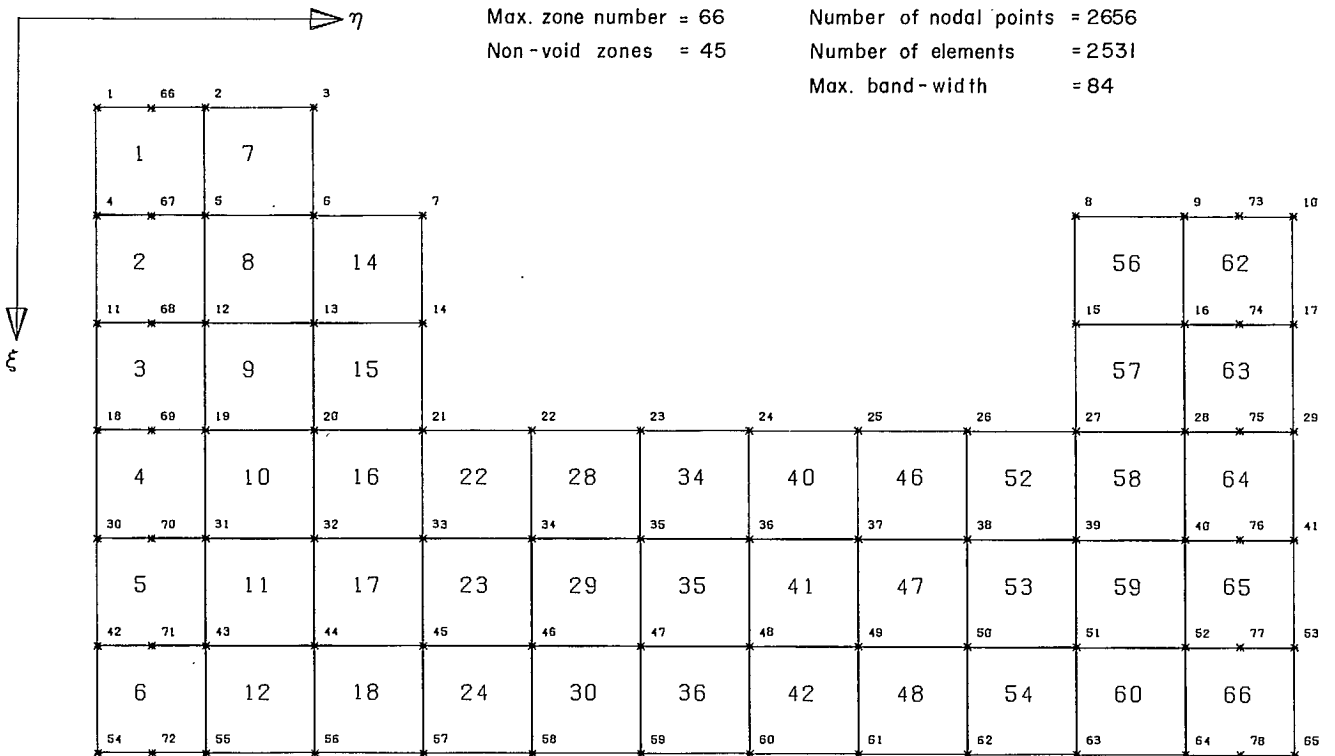

Fig B-8(b) - Key diagram - simulation of an open pit mine.

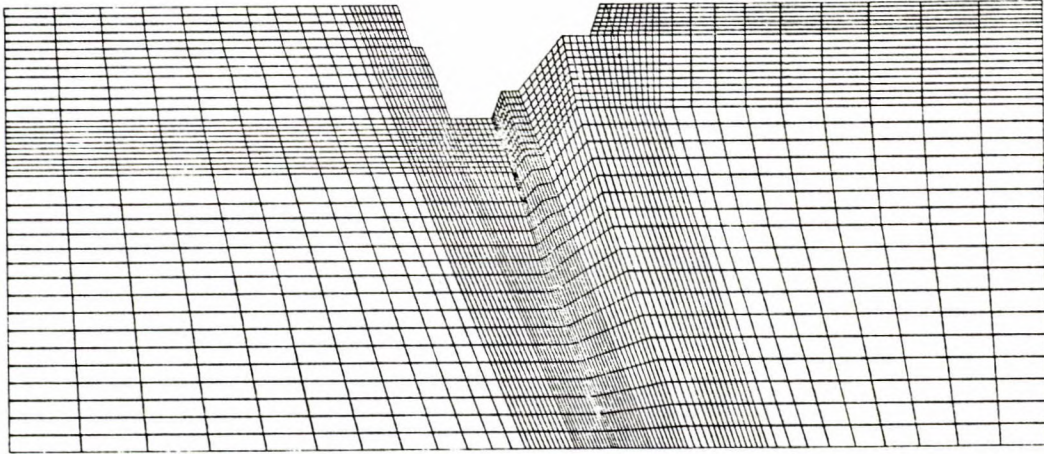

Fig B-8(c) - Finite element discretization - simulation of an open pit mine.

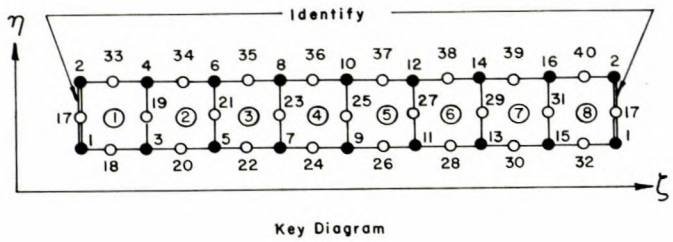
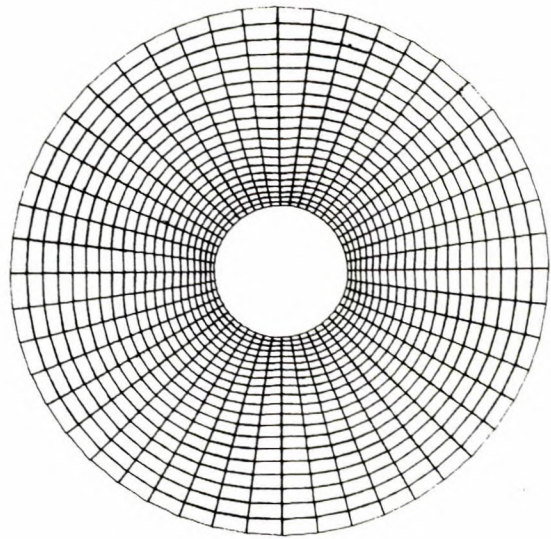
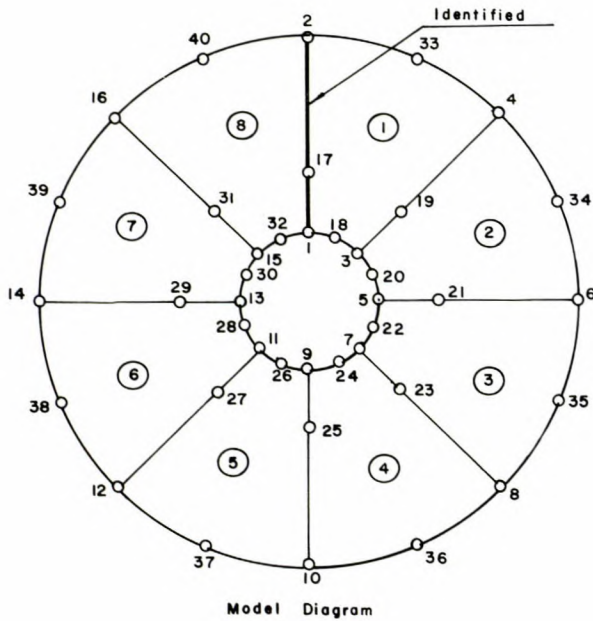

Fig B-9 - Use of identification facility.



HDING - 80 character (8 word) problem title or heading

b. Card #2 Control Card

FORMAT (6I5)

READ , NSPNP, NVZONE, NSPAN1, NSPAN2, NPROB, NSIDNT

NSPNP - total number of specified nodal points

NVZONE - total number of non-void zones

NSPAN1 - total number of spans in the EPS direction

NSPAN2 - total number of spans in the ETA direction

NPROB - the number of subproblems making up an excavation sequence. Default value is 1.

NSIDNT - identification indicator, '0' or blank no identification, '1' identification required

c. Card #3 Printer-plot size card

FORMAT(2I5)

READ , INCHA, INCHD

INCHA - inches across printer page. Maximum is 13 inches. Default is 10 inches.

INCHD - inches down printer page. There is no maximum except limitation imposed by amount of central memory available. Default is 10 inches.

Note: MSHGEN will produce a printer-plot of the zone diagram unless INCHA is negative. The program will rotate the zone diagram through 90 degrees if a better printer plot results. The location of all specified nodal points are denoted by \*'s.

d. Cards defining zone subdivisions

FORMAT(16I5)

READ , (NSBDV1(I), I = 1, NSPAN1)

READ , (NSBDV2(I), I = 1, NSPAN2)

NSBDV1( ) - array defining number of subdivisions in each zone in the EPS direction

NSBDV2( ) - array defining number of subdivisions in each zone in the ETA direction

e. Block of NSPNP cards defining specified nodal points

FORMAT (2I5, 2E15.0)

READ , N, NCDOSP(N), XSP(N), YSP(N)

N - specified nodal point number

NCDOSP(N) - condition code of specified nodal point N. The table below defines the

possibilities.

NCDOSP(N) Constraint at Node N

0 No constraint on displacements

1 X - displacement = 0

2 Y - displacement = 0

3 X - displacement = Y - displacement = 0

XSP(N) - X - coordinate of node N

YSP(N) - Y - coordinate of node N

Note: The cards specifying the nodes must be in sequential order 1 to NSPNP

f. Block of cards defining zones

With each non-void zone there is associated 1-5 cards as follows:

Card #1 Zone specification

FORMAT (12I5)

READ , N, (IZ(J,N), J = 1,8), MATZ(N), NCUTZ(N), NUMPC

N - non-void zone number

IZ( ,N) - nodal numbers defining non-void zone N. This is described more completely below. (See Note 1).

MATZ(N) - the material number associated with non-void zone N. The default value is 1. This is described more completely below (See Note 2).

NCUTZ(N) - the cut number associated with non-void zone N. If blank or zero, it is assigned the value NPROB + 1, ie elements in this zone will never be removed (See Note 3).

NUMPC - the number of sides (0-4) of non-void zone N with pressure applied, ie the number of cards defining pressure loading following this card.

If NUMPC is greater than zero then the above card is followed by

'NUMPC' cards defining pressure sides on zone N

FORMAT (I5, 2E15.7)

READ , NSIDE, P1, P2.

NSIDE - the side number of the zone. See Fig B-10 for the numbers associated with sides.

P1 - the pressure at node 1 of zone side 'NSIDE' (See Note 4).

P2 - the pressure at node 2 of zone side 'NSIDE'.

41. Note 1. Zone Specification. The corner

nodes must always be specified. Intermediate nodes of zero or blank are assumed by MSHGEN to be midpoint nodes. Once the global (EPS,ETA) reference system has been selected, the order in which nodes are specified is rigid. Order of node specification is counterclockwise starting with the node at (MIN(EPS), MIN(ETA)).

42. Note 2. Material Specification. Different materials should be given numbers 1 to NUMMAT. Where NUMMAT is the number of different materials. The reason for this is that MSHGEN assumes that the maximum material number equals the number of different materials.

43. Note 3. Cut Number. Excavation sequences can be simulated by assigning a cut number to a zone. All elements in a zone will be eliminated when the subproblem number equals the cut number. A cut number of one means that elements in this zone will never be used. Elements with cut number greater than NPROB (the maximum number of subproblems) will never be deleted.

44. Note 4. Pressure Specification. The zone sides can be assigned linearly varying pressures by giving the pressure at the side end points. The zone sides are considered as directed lines as shown in Fig B-10. The initial point is P1 and the final point P2. Only constant pressure (ie  $P1=P2$ ) can be assigned on sides which are curvilinear.

#### Example of Input

45. The input cards for the illustrative example (Fig B-6(g)), previously discussed, are given in Fig B-11.

#### MSHGEN Output

##### A. Printer Output

As well as reproducing the input data and a printer-plot (optional), MSHGEN also prints out the number of nodes and elements generated, the maximum element nodal point difference, the element number in which this difference first occurs, the number of different materials and the number of element pressure sides generated. One example of the printer-plotted zone diagram is shown in Fig B-12, which is used as a pre-

liminary check on the accuracy of the input for MSHGEN.

##### B. Output on fortran logical unit No. 1.

###### a. Record #1 FORMAT (5I5,8A10)

```
WRITE, NUMNP, NUMEL, NPROB, NPRES, NUMMAT,
HDING.
```

NUMNP - number of nodal points generated.

NUMEL - number of elements generated.

NPROB - number of subproblems.

NPRES - number of pressure sides.

NUMMAT - number of different materials.

HDING - 8 word (80 character) heading.

###### b. Block of 'NUMNP' records

```
FORMAT (2I5, 2E15.5)
```

```
WRITE , I, NCODE(I), X(I), Y(I)
```

I - nodal point number

NCODE(I) - condition code of this node

X(I), Y(I) - coordinates of node

###### c. Block of cards defining elements and pressure loading. For each element there are 1 + NUMPC records.

```
Record #1 FORMAT (8I5)
```

```
WRITE , I, (IX(J,I),J=1,4), MAT, NCUT,
NUMPC
```

I - element number.

IX - 4 nodes defining quadrilateral element I.

MAT - material number of element.

NCUT - cut number of element.

NUMPC - number of pressure cards associated with element.

If NUMPC is positive then above card is followed by:

NUMPC cards

```
FORMAT(15,2G15.7)
```

```
WRITE , NSIDE, P1, P2
```

NSIDE - the directed side number.

P1 - pressure at initial point of directed side 'NSIDE'.

P2 - pressure at final point of directed side 'NSIDE'.

#### MSHGEN STORAGE REQUIREMENTS

46. Sufficient storage must be allocated in blank common array ID for proper operation of

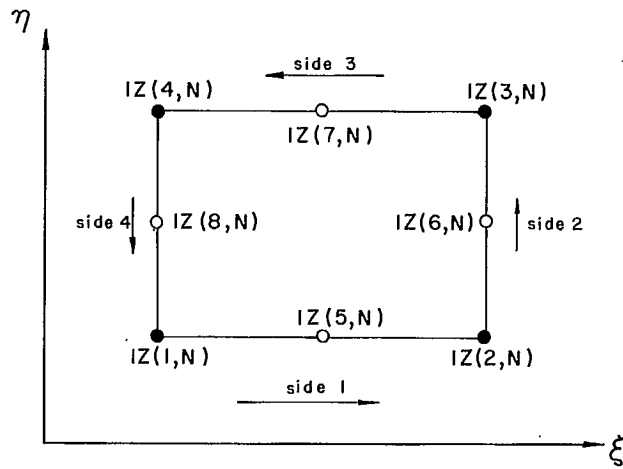

Fig B-10 - Specification of zone N.

A HYPOTHETICAL SLOPE									
17	4	2	3	1	0				
6	8								
5	15								
10	5	5							
1	3			0.00		0.00			
2	2			200.00		0.00			
3	3			800.00		0.00			
4	1			0.00		250.00			
5	0			200.00		250.00			
6	1			800.00		250.00			
7	0			286.60		400.00			
8	1			800.00		400.00			
9	0			373.20		550.00			
10	1			800.00		550.00			
11	1			0.00		162.50			
12	0			200.00		162.50			
13	1			800.00		162.50			
14	2			410.00		0.00			
15	0			410.00		250.00			
16	0			466.69		400.00			
17	0			522.58		550.00			
1	1	2	5	4	0	12	0	11	1
2	2	3	6	5	14	13	15	12	1
4	5	6	8	7	15	0	16	0	1
6	7	8	10	9	16	0	17	0	1

Fig B-11 - Input for the illustrative example.

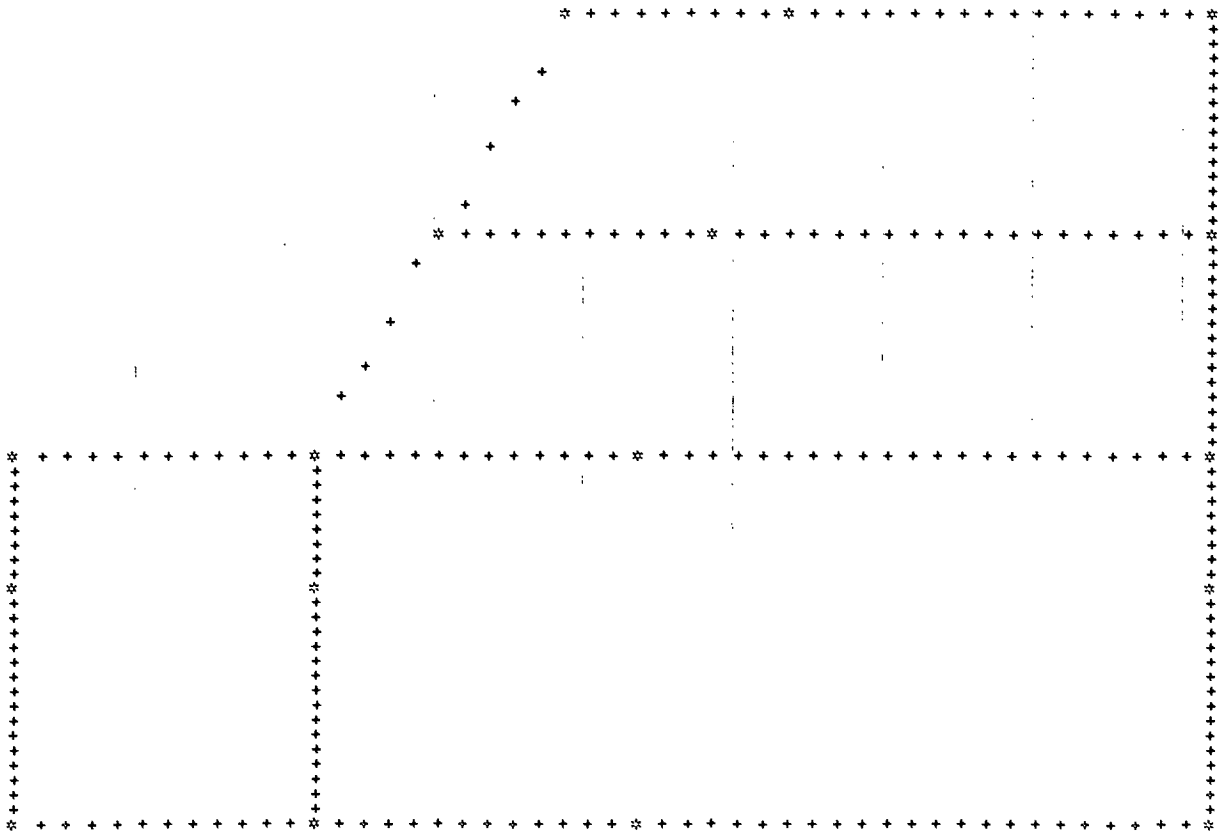

Fig B-12 - Example of printer-plotted zone diagram (Specified nodal points are denoted by \*).

MSHGEN.

47. The amount of blank common storage 'MXDIM' should be equal to or greater than:  $3 \times \text{NSPNP} + 22 \times \text{NSPAN1} \times \text{NSPAN2} + \text{NSPAN1} + \text{NSPAN2} + \text{MAX}(3 \times \text{NUMNP} + 7 \times \text{NUMEL} + 2 \times \text{NPRES}, 6 \times \text{INCHA} \times \text{INCHD} + \text{INCHA} + 6 \times \text{INCHD} + 1)$ , where NSPNP = number of specified nodal points, NSPAN1 = number of spans on EPS direction, NSPAN2 = number of spans on ETA direction, NUMNP = number of nodal points generated, NUMEL = number of elements generated, NPRES = number of element pressure sides generated, INCHA = inches printer-plot across page, and INCHD = inches printer plot down page.

48. Two fortran cards, (MSHGEN 26, MSHGEN 27), must be changed in the main programs of MSHGEN if storage requirements are changed, ie COMMON ID('MXDIM') and MXDIM = 'MXDIM'

49. For the CDC6400 or CYBER74 the total storage requirements to load and execute MSHGEN are (in decimal):  $12000 + \text{Max}(\text{MXDIM}, 5000)$ .

50. The fortran used is standard except that associated with the production of the plot. Because of the character manipulation involved, it is somewhat machine dependent.

#### MSHPLT

##### General

51. One way to check whether a generated finite element mesh is adequate is to plot the mesh and inspect it visually. MSHPLT is a mesh plotting program especially designed to be used in conjunction with MSHGEN. CALCOMP plotting software is used.

52. The plotting program contains certain options which enhance its usefulness. (a) A rectangular region can be specified and only elements inside this region plotted. This allows magnification of given areas of the mesh. (b) A rectangular region can be specified and only elements exterior to this region are plotted. This allows the user to exclude a highly refined area of his mesh. (c) Nodal numbers can be plotted. The user can specify a skip constant so that not all numbers need be plotted. (d) Element numbers can be plotted. Again a skip constant can

be specified to avoid plotting all element numbers. (e) To help distinguish between plotted nodal numbers and plotted element numbers the nodal numbers are plotted horizontally and the element numbers vertically. (f) The coordinate scale factor if not specified is automatically calculated by MSHPLT.

53. The current version of MSHPLT contains a restriction which should be removed in future versions. This is that only one highly refined area can be excluded. It would be desirable if several rectangular areas could be specified for exclusion.

##### MSHPLT Card Input

Card #1 Identification Card

FORMAT (20A1, 10X, 20A1)

READ , (NAME(I), I=1,20), (ADDRESS(I), I=1,20)

NAME - User name - up to 20 characters may be used.

ADDRESS - User address - up to 20 characters may be used.

54. A number of plots can be made using the same MSHGEN generated model. For instance various rectangular areas might be selected for plotter magnification. Each plot has associated with it a Plot Parameter Card and possibly a Specified Rectangle Card in the following format.

Plot Parameter Card

FORMAT (2F10.0, 3I5, 2F10.0)

READ , YPLTIN, XPLTIN, NBOUND, NSKPNP, NSKPEL, SCALE, AROT

YPLTIN - the plot width limit in inches. Note 1 below clarifies how this is related to width of the plot paper. The default value is 10 inches.

XPLTIN - the plot length limit in inches. The default value is 50 inches.

NBOUND - If NBOUND = 0 the whole model is plotted. If NBOUND = 1 only the interior of the specified rectangle is plotted. If NBOUND = 2 only the exterior of the specified rectangle is plotted.

NSKPNP - the nodal point number skip constant. Every NSKPNP nodal point number is plotted. If NSKPNP = 0 no nodal numbers are plotted.

NSKPEL - the element number skip constant. Every NSKPEL element number is plotted. If NSKPEL = 0 no element numbers are plotted.

SCALE - user specified coordinate scale factor in logical units per inch. If zero or blank, then the program will calculate scale using the value of YPLTIN and XPLTIN.

AROT - this is a rotation indicator. If AROT=0. then MSHGEN x-axis and y-axis must correspond with plotter x-axis and y-axis. If AROT=90, then axes are rotated by 90 degrees prior to plotting.

The following card follows the Plot Parameter Card only if

NBOUND = 1 or 2.

Specified Rectangle Card

FORMAT(A3,7X,4F10.0)

READ ,ALPHA,XSPMN,XSPMX,YSPMN,YSPMX

ALPHA - the first three columns must contain the letters BND.

XSPMN - the left side of specified rectangle in logical coordinates.

XSPMX - the right side of specified rectangle in logical coordinates.

YSPMN - the lower side of specified rectangle in logical coordinates.

YSPMX - the upper side of specified rectangle in logical coordinates.

55. The program recognizes the end of the data by the presence of an end of file card.

56. Note 1: Considerations in selecting YPLTIN. MSHPLT selects a plotter origin 0.5 in. above the lower edge of the plot paper. The minimum x-value and minimum y-value of the region to be plotted are taken as the logical coordinates of the plotter origin. Thus the whole plot will be above and to the right of the plotter origin. If SCALE is not specified, then SCALE is calculated so that the region to be plotted lies within the plotter size limits XPLTIN and YPLTIN. Normally YPLTIN will be the constraint on the plot size (if SCALE is specified the plotted region must be within the plotter size limits or the job will abort). If only the finite element mesh (with no element numbers) is desired then YPLTIN will have a maximum value of 0.5 inch less than

the plotter paper width. Element numbers if requested are plotted vertically upward from centre of the element. If the elements near the upper surface are small and the element numbers large then the plotted numbers can extend beyond the mesh (the plotted height for both nodal point numbers and element numbers is 0.07 inch). If element numbers are requested, the maximum YPLTIN possible is the paper width minus 1 inch (the paper width - 1.5 inch will give a 0.5 border above as well as below).

#### Storage Requirements

57. The blank storage specified in MSHPLT must be greater than or equal to  $2 \times \text{NUMNP} + 4 \times \text{NUMEL}$ . NUMNP and NUMEL are the numbers of nodal points and number of elements generated by MSHGEN respectively. Take 'MXDIM'  $\geq 2 \times \text{NUMNP} + 4 \times \text{NUMEL}$ , modify default values: COMMON IP(3000) (line MSHPLT.94) and MXDIM = 3000 (line MSHPLT.95) to COMMON IP('MXDIM') and MXDIM = 'MXDIM'.

58. On the CDC CYBER 74(SCOPE 3.4) the total storage requirements for loading and executing MSHPLT are (in decimal):  $13050 + \text{MAX}('MXDIM', 6000)$ .

SAP2DC

#### General

59. MSHGEN produces only part of the data required by SAP2D (nodal data, element data and pressure data). Necessary SAP2D information such as material properties and concentrated forces are absent. SAP2DC merges this additional card information with the output (GENOUT) of MSHGEN to produce an input file (SAPIN) acceptable to SAP2D.

60. SAP2D is not capable of producing a fully general input file for SAP2D. The following restrictions apply: (a) no thermal effects; (b) only one load case; (c) no boundary elements, and (d) gravity loads (if any) occur in (-Z) direction.

#### SAP2DC Card Input

a. Card #1 Title or heading  
FORMAT(8A10)

READ , TITLE  
 TITLE - 80 character (8 word) title  
 Default - if card is blank then the MSHGEN title card is used

b. Card #2 Control card

FORMAT(5I5,F10.0)

READ , NP, NRES, IMAT, ICF, ICOMP, SCALE

NP - type of structure indicator; 0 = plane strain; 1 = axisymmetric; and -1 = plane stress.

NRES - initial stress indicator. If NRES is nonzero SAP2D will attempt to calculate initial stresses using the subroutine CALRS4.

IMAT - anisotropic material properties indicator. If IMAT=0 then all materials are assumed to have isotropic material properties. If IMAT≠0 then one or more materials have anisotropic properties.

ICF - concentrated force indicator. If ICF≠0 then no concentrated forces are input. If ICF=0 then concentrated forces are input.

ICOMP - incompatible mode indicator. If ICOMP≠0 then incompatible modes are suppressed in calculating the stiffness matrices in SAP2D. If the structure is axisymmetric incompatible modes are always suppressed.

SCALE - coordinate scaling factor. MSHGEN generated coordinates are multiplied by SCALE. Default value for SCALE is SCALE = 1.

c. Card #3 Printer control card

FORMAT(3I5)

READ , NPRINP, NPRDIS, NPRSTR

NPRINP - input print indicator. If nonzero the printing of input data will be suppressed in SAP2D.

NPRDIS - displacement print indicator. If nonzero the printing of SAP2D displacement output will be suppressed.

NPRSTR - stress print indicator. If nonzero the printing of SAP2D stress output will be suppressed.

d. Block of cards defining material properties.

If IMAT = 0 (isotropic material properties) then there are

'NUMMAT' cards.

FORMAT (I5,3E15.7)

READ , N, E, RNU, WGT

N - material number.

E - Youngs modulus.

RNU - Poissons ratio.

WGT - weight density.

If IMAT ≠ 0 (anisotropic material properties) then there are '3\*NUMMAT' cards. The format and content of these cards is identical to that given in SAP2D.

If ICF ≠ 0 the following block appears.

e. Block defining concentrated force data.

The format and contents are exactly as in SAP2D This block of cards is terminated by a blank card.

61. Note 1. If IMAT≠0 then the material properties of all materials must be entered in SAP2D format even if some of the materials are isotropic.

62. Note 2. Material property and concentrated force data is not checked by SAP2DC, ie the whole card is merely listed and transferred to the SAP2D input file.

63. Note 3. NUMMAT - the number of different materials is transferred from MSHGEN.

Storage Requirements

64. On the CYBER 74 the central memory needed to load and execute SAP2DC is 15000 decimal or 35210 octal.

CONTROL CARDS

General

65. In this section some typical control card layouts needed to run the SAP2D system of programs are given. This only has meaning for the CDC 6000 series or CYBER series of computers running under the SCOPE 3.4 operating system.

Transfer of Programs from Tape to Disk

66. The SAP2D system of programs normally resides on a multifile tape ER\*\*\*\*(get current tape number from tape listing). The first file (L=SAP2D) contains all the source programs in UPDATE format. The second file (L=SAP2DLIB) contains the EDITLIB processed library containing

binary versions of all subprograms of MSHGEN, MSHPLT and SAP2D as well as all of SAP2DC.

67. When a series of SAP2D runs are to be made, it is usually worthwhile (avoids tape mounting charges and gives better turn-around time) to transfer the tape files to permanent disk files.

68. Figure B-13 shows the control cards necessary to create two permanent disk files with file names SAP2D and SAP2DLIB with a retention period of 15 days.

#### Executing MSHGEN Alone

69. In most cases it is probably best initially to run MSHGEN by itself. MSHGEN is economical to run and does fairly extensive checking of input data including the production of a printer plot. Thus the majority of input errors can be removed quickly and inexpensively. Figure B-14 shows a typical card layout to execute MSHGEN.

#### Executing MSHGEN and MSHPLT

70. The only way to check the adequacy, in particular the mesh grading and element aspect ratios, of the finite element mesh generated by MSHGEN is by visual inspection of a plot. If the mesh is not satisfactory then modification must be made to MSHGEN input (usually these modifications are of a very minor nature, eg relocation of intermediate specified points or changing the number of subdivisions). The routine MSHPLT does the plotting of the MSHGEN generated mesh. Figure B-15 gives a typical card layout to execute MSHGEN and MSHPLT.

#### Executing MSHGEN, SAP2DC and SAP2D

71. When the user is satisfied with the MSHGEN generated mesh, the finite element analysis can be carried out using SAP2DC and SAP2D. Figure B-16 gives a typical card layout. Note that a tape 'SAPOUT' has been mounted with a retention period of 30 days to hold SAP2D output. Note also that the MTOT required by SAP2D as well as the central memory requirements of SAP2D are output by MSHGEN.

## SAP2D

### Introduction

72. SAP2D is a static, linear elastic finite element program for the analysis of 2-dimensional structures (plane or axisymmetric). Most of the program was extracted from Wilson's SAP program (B-1). Initial stresses, temperature effects, simulation of excavation sequences, arbitrary distributed loading, gravity loading and concentrated force loading can be handled by this program.

73. The global axis is considered to be a right handed Y-Z system in the plane case or a right-handed R-Z system in the axisymmetric case.

### Type of Elements

74. The basic element used is an isoparametric quadrilateral. A triangle is treated as a degenerate quadrilateral. To increase the accuracy of the element, incompatible displacement modes can be added, ie displacements need no longer be continuous across element boundaries, although to guarantee convergence displacement discontinuities over element sides must tend to zero as the element size tends to zero. If not desired, these incompatible modes can be suppressed by changing an input parameter.

75. If SAP2D is used without boundary elements, it is possible only to specify zero displacements in the Y (or R) or Z global directions. It is not possible to specify nonzero displacement or even zero displacements in other than the global system.

76. A boundary element is a point element (it has a 2x2 stiffness matrix) with only axial stiffness, ie acts like a spring.

77. To define a boundary element it is necessary to specify two nodal points, one node gives the location of the boundary element and the second is only used to define the axial direction of the element. If no convenient direction node already exists then the user will have to create an artificial node. These artificial nodes should



```

H8543,CM47000,T100,P2,MT1. INPUT TAPE ER****
ACCOUNT,12345.
REQUEST,NEWPL,*PF.
REQUEST,LIB,*PF.
REQUEST,SAP,MF,E. ER****
LABEL,OLDPL,R,L=SAP20,P=1,M=SAP.
UPDATE(N,C=0)
CATALOG(NEWPL,SAP20,ID=MRL,RP=15)
LABEL,TAPLIB,R,L=SAP2OLIB,P=2,M=SAP.
COPYBF(TAPLIB,OSKLIB)
REWIND,OSKLIB.
EDITLIB.
CATALOG(LIB,SAP2OLIB,ID=MRL,RP=15)
7/8/9 MULTIPLE PUNCH IN COLUMN 1
7/8/9 MULTIPLE PUNCH IN COLUMN 1
SEQTORAN(OSKLIB,LIB)
ENDRUN.
7/8/9 MULTIPLE PUNCH IN COLUMN 1
6/7/8/9 MULTIPLE PUNCH IN COLUMN 1 DENOTING END OF JOB

```

Fig B-13 - Control cards to transfer programs from tape to disk.

```

H4627,CM47000,T100,P2.
ACCOUNT,12345.
ATTACH,OLDPL,SAP20,ID=MRL,MR=1.
ATTACH,SAPLIB,SAP2OLIB,ID=MRL,MR=1.
LIBRARY,SAPLIB.
UPDATE(L=A1,C=MSHGEN)
FTN(I=MSHGENS,B=MSHGEN,OPT=1,L=0)
MSHGEN.
7/8/9 MULTIPLE PUNCH IN COLUMN 1
* C MSHGEN
* IOENT MMSHGEN
* D MSHGEN-26,27
COMMON ID(4120)
MXDIM=4120
7/8/9 MULTIPLE PUNCH IN COLUMN 1
A HYPOTHETICAL SLOPE
17 4 2 3 1 0
6 8
5 15
10 6 6
1 3 0.0 0.0
2 2 200.0 0.0
3 3 800.0 0.0
4 1 0.0 250.0
5 0 200.0 250.0
6 1 800.0 250.0
7 0 286.6 400.0
8 1 800.0 400.0
9 0 373.2 550.0
10 1 800.0 550.0
11 1 0.0 162.5
12 0 200.0 162.5
13 1 800.0 162.5
14 2 410.0 0.0
15 0 410.0 250.0
16 0 466.7 400.0
17 0 522.6 550.0
1 1 2 5 4 0 12 0 11 1
2 2 3 6 5 14 13 15 12 1
4 5 6 8 7 15 0 16 0 1
6 7 8 10 9 16 0 17 0 1
7/8/9 MULTIPLE PUNCH IN COLUMN 1
6/7/8/9 MULTIPLE PUNCH IN COLUMN 1 DENOTING END OF JOB

```

Fig B-14 - Control cards with an example of input data to execute MSHGEN.

```

H4628,CM47000,T100,P2,MT1.
ACCOUNT,12345.
REQUEST,PLOTTER.
ATTACH,PLTSUB,PLOTLIB,MR=1.
ATTACH,OLDPL,SAP2D,ID=MRL,MR=1.
ATTACH,SAPLIB,SAP2DLIB,ID=MRL,MR=1.
LIBRARY,SAPLIB.
UPDATE(L=A1,C=MSHGENS)
UPDATE(L=A1,C=MSHPLTS)
FTN(I=MSHGENS,B=MSHGEN,OPT=1,L=0)
FTN(I=MSHPLTS,B=MSHPLT,OPT=1,L=0)
MSHGEN(INPUT,OUTPUT,GENOUT)
LDSET(LIB=PLTSUB)
MSHPLT(INPUT,OUTPUT,GENOUT) 'YOUR NAME AND ADDRESS'
7/8/9 MULTIPLE PUNCH IN COLUMN 1
*C MSHGEN
*IDENT MDMSHGEN
*D MSHGEN.26,27
COMMON ID(4120)
MXDIM=4120
7/8/9 MULTIPLE PUNCH IN COLUMN 1
*C MSHPLT
*IDENT MDMSHPLT
*D MSHPLT.84,85
COMMON IP(2400)
MXDIM=2400
7/8/9 MULTIPLE PUNCH IN COLUMN 1

      A HYPOTHETICAL SLOPE
17      4      2      3      1      0
6      8
5      15
10     6      6
1      3      0.0      0.0
2      2      200.0      0.0
3      3      800.0      0.0
4      1      0.0      250.0
5      0      200.0      250.0
6      1      800.0      250.0
7      0      286.6      400.0
8      1      800.0      400.0
9      0      373.2      550.0
10     1      800.0      550.0
11     1      0.0      162.5
12     0      200.0      162.5
13     1      800.0      162.5
14     2      410.0      0.0
15     0      410.0      250.0
16     0      466.7      400.0
17     0      522.6      550.0
1      1      2      5      4      0      12      0      11      1
2      2      3      6      5      14      13      15      12      1
4      5      6      8      7      15      0      16      0      1
6      7      8      10     9      16      0      17      0      1
7/8/9 MULTIPLE PUNCH IN COLUMN 1
YOUR NAME 12.      18.      0      YOUR ADDRESS
7/8/9 MULTIPLE PUNCH IN COLUMN 1
6/7/8/9 MULTIPLE PUNCH IN COLUMN 1 DENOTING END OF JOB

```

Fig B-15 - Control cards with an example of input data to execute MSHGEN and MSHPLT.

```

H8541,CM100000,T200,P2,MT1.
ACCOUNT,12345.
ATTACH,OLDPL,SAP2D,ID=MRL,MR=1.
ATTACH,SAPLIB,SAP2DLIB,ID=MRL,MR=1.
LIBRARY,SAPLIB.
UPDATE(L=A1,C=MSHGENS)
UPDATE(L=A1,C=SAP2DS)
FTN(I=MSHGENS,B=MSHGEN,OPT=1,L=0)
FTN(I=SAP2DS,B=SAP2D,OPT=1,L=0)
MSHGEN(INPUT,OUTPUT,GENOUT)
SAP2DC(INPUT,OUTPUT,GENOUT,SAPIN)
LABEL,SAPOUT,W,L=SAP2DOUTPUT,T=30.
FILE(TAPE4,RT=S,BT=C)
FILE(TAPE7,RT=S,BT=C)
FILE(TAPE9,RT=S,BT=C)
FILE(TAPE11,RT=S,BT=C)
LDSET(QMIT=BOUND,FILES=TAPE4/TAPE7/TAPE9/TAPE11)
SAP2D(SAPIN)
7/8/9    MULTIPLE PUNCH IN COLUMN 1
*C MSHGEN
*IDENT MDMSHGEN
*D MSHGEN.26,27
      COMMON ID(4120)
      MXDIM=4120
7/8/9    MULTIPLE PUNCH IN COLUMN 1
*C SAP2D
*IDENT MOSAP2D
*D SAP2D.15,16
      COMMON A(5200)
      MTOT=5200
7/8/9    MULTIPLE PUNCH IN COLUMN 1

```

```

          A HYPOTHETICAL SLOPE
17      4      2      3      1      0
6       8
5      15
10     6      6
1       3          0.0          0.0
2       2          200.0         0.0
3       3          800.0         0.0
4       1          0.0          250.0
5       0          200.0         250.0
6       1          800.0         250.0
7       0          286.6         400.0
8       1          800.0         400.0
9       0          373.2         550.0
10      1          800.0         550.0
11      1          0.0          162.5
12      0          200.0         162.5
13      1          800.0         162.5
14      2          410.0          0.0
15      0          410.0         250.0
16      0          466.7         400.0
17      0          522.6         550.0
1       1      2      5      4      0      12      0      11      1
2       2      3      6      5      14      13      15      12      1
4       5      6      8      7      15      0      16      0      1
6       7      8      10     9      16      0      17      0      1
7/8/9    MULTIPLE PUNCH IN COLUMN 1
          ILLUSTRATIVE EXAMPLE - A HYPOTHETICAL SLOPE
0       0      0      0      1      12.0
1       0      0
1       10.E+6          .25          .09838
2       8.E+6          .25          .09837
3       5.E+6          .25          .09837
7/8/9    MULTIPLE PUNCH IN COLUMN 1
6/7/8/9  MULTIPLE PUNCH IN COLUMN 1 DENOTING END OF JOB

```

Fig B-16 - Control cards and example of input data to execute MSHGEN, SAP2DC and SAP2D.

be fully constrained so that no equations are assembled for them.

78. For each boundary element a displacement and an axial stiffness is specified on the input card. The boundary element routine then applies an axial force equal to the product of the specified displacement and the axial stiffness. If the stiffness specified is large compared to the stiffness of the structure at the point, the calculated displacement at the point will be approximately equal to the specified displacement.

79. The effect of a spring support can be simulated by letting the specified displacement equal zero and setting the specified axial stiffness equal to the spring stiffness.

#### Initial Stresses

80. SAP2D provides for the input of analytically expressed initial stresses by suitably modifying the SAP routine CALRS4. This subroutine supplies the coordinates of the point at which the initial stress is needed. These are the integrating points used for constructing the element stiffness matrix. CALRS4 calculates and returns the stresses. SAP2D needs the initial stresses at all the gaussian integration points of each element.

#### Temperature Effects

81. Given nodal temperatures and thermal expansion coefficients SAP2D can be used to calculate thermal stresses. Reference temperatures for all elements can be input with the elements. This reference state defines zero thermal stress.

82. By inputting the variation of material properties with temperature in tables, these variations can be taken into account.

83. The current version of SAP2D has no facility for inputting nodal temperatures. Normally these would reside on some storage device and would have to be input in the routine INPUTJ by suitably modifying the coding from INPUTJ.67 to INPUTJ.69.

#### Structural Loading

84. As well as initial stress and temperature

loading as described above, it is possible using SAP2D to load the structure by distributed loads (pressures and shears), gravity loads and concentrated nodal loads.

85. The major expense in running large SAP2D problems arises from solving the relevant equations. The major component of this expense is in the decomposition of the stiffness matrix. The additional cost for multiple load vectors is relatively small. To take advantage of this and so reduce the cost, SAP2D provides the following procedure for construction of multiple load vectors.

86. The number of load cases LL is input on the control card. For each load case the nonzero concentrated nodal loads are input directly. The element forces due to temperature effects, pressure, shear loading, initial stress loads and gravity loads are stored in separate arrays for each element when the element is assembled.

87. For each load case a set of six load multipliers are defined. A load vector is then found by adding to the concentrated loads for that load case a linear multiple of the load multipliers and the stored force arrays for each element. Thus by using various load multipliers various load vectors can be generated. The first multiplier multiplies the thermal stress loads, the second the Y (or R) component of the distributed loads, the third the Z component of the distributed loads, the fourth the initial stress loads, the fifth the Y component of the gravity and the sixth the Z component of the gravity.

#### Cuts

88. Cuts provide a convenient means for simulating excavation sequences. Suppose an excavation sequence is to be simulated by solving NPROB distinct subproblems. By associating with each element a number called a cut number corresponding to the subproblem in which the element is removed (the element remains removed for higher subproblem numbers) the simulation is readily carried out. Note that an element with cut number equal to one would never be used, whereas an element with cut

number "NPROB + 1" would never be removed.

### Stress Calculation

89. By means of a parameter on the element input card the user can control where stresses are calculated for this particular element. Thus it is possible to calculate no stresses or calculate "centroid" stresses and/or possibly certain stresses at midpoints of element sides.

90. The centroid stresses are calculated with respect to the global Y - Z coordinate system. At a midpoint node the stresses are calculated with respect to a local coordinate system defined by the outward normal of the element side containing the midpoint and the side itself with direction counterclockwise about the element.

91. As well as calculating the stresses as described above, the major and minor principal stresses and their direction angle are calculated at each stress point. The angle for the centroid stress is with respect to the Y-axis, and for midpoint stresses the angle is measured with respect to the outward normal.

### Units

92. Any consistent set of units is acceptable, eg if coordinates are in inches, Young's moduli in psi, pressures in psi, weight density in pci, then SAP2D will output displacements in inches and stresses in psi. If coordinates are in meters, Young's moduli in kPa, pressures in kPa, weight density in Newton/m<sup>3</sup>, then SAP2D will output displacements in meters and stresses in kPa.

### SAP2D Input

#### 93. Input Summary

- a. Problem Identification and Control Cards
- b. Nodal Point Input
- c. Plane or Axisymmetric Element Data: (a) Element Parameter Card, (b) Data Defining Material Properties, and (c) Element Specification.
- d. Boundary Element Data: (a) Element Parameter Card, and (b) Boundary Element Specification.
- e. Concentrated Nodal Load Input
- f. Load Multipliers

#### 94. Detailed Input Description

### A. Problem Identification and Control Cards

#### a. Card No. 1-Title Card

FORMAT (8A10)

READ , HED

HED - an 8 word array where title is stored

#### b. Card No. 2-Control Card

FORMAT (9I5,F10.0)

READ , NUMNP, NELTYP, LL, NPRNT, NPROB, NRES, INDTMP, SCALE

NUMNP - number of nodal points.

NELTYP - number of element types (1 or 2). This is equal to 2 only if boundary elements as well as plane or axisymmetric elements are used. The default value is 1.

LL - number of load cases, ie the number of force vectors that are formed. The default value is 1.

NPRNT - Three word array print indicator. If nonzero or blank printing is performed.

NPRNT (1) controls printing of input data.

NPRNT (2) controls printing of displacement output. NPRNT (3) controls printing of stress output.

NPROB - the number of subproblems. Default is 1.

NRES - initial stress indicator. If nonzero initial stresses are calculated using CALRS4. In this case the appropriate coding must be inserted in CALRS4.

INDTMP - temperature effect indicator. If this parameter is nonzero, temperature effects are to be considered by program.

SCALE - scaling factor for Y(orR) and Z-coordinates. The default value is 1.

Note: material properties are not scaled by this factor, ie material properties must be input using the scaled units.

### B. Nodal Point Input

Each non-generated nodal point has a card associated with it as follows:

FORMAT (3I5, 2E15.7,I5)

READ , N, ID(N,1), ID(N,2), Y(N), Z(N), KN

N - nodal number.

ID(N,1) - Y or R constraint indicator: a zero displacement in Y or R-direction is indicated if this indicator is nonzero.

ID(N,2) - Z constraint indicator: a zero displacement in the Z-direction is indicated if this indicator is nonzero.

Y(N) - Y or R coordinate of node N.

Z(N) - Z coordinate of node N.

KN - node generation parameter. This is explained more fully below (note 1).

95. Note 1. Nodal Point Generation. If the nodal structure is sufficiently regular, it may be possible to generate certain nodal points using the simple SAP2D nodal point generator. This generator works as follows. Suppose that two consecutive cards are read, the first with nodal number NOLD and with coordinates Y(NOLD) and Z(NOLD) and the second card with nodal number N, coordinates Y(N) and Z(N) and generation parameter KN. If KN is less than or equal to zero no generation occurs. If KN is positive then NUM nodes will be generated (if NUM is positive) where NUM is the largest integer such that  $NOLD + NUM * KN$  is less than N. The generated points lie equally spaced on the line joining (X(NOLD), Y(NOLD)) and (X(N), Y(N)) and are given nodal numbers  $NOLD + KN$ ,  $NOLD + 2 * KN$ , ---,  $NOLD + NUM * KN$  respectively. The generated nodal points have unconstrained displacements unless one or both of the constraint indicators at NOLD is negative in which case the corresponding generated displacement constraint will also be negative.

#### C. Plane or Axisymmetric Element Data

##### a. Element Parameter Card

FORMAT (6I5)

READ, NPAR(1), NPAR(2), NPAR(3), NPAR(4), NPAR(5), NPAR(6)

NPAR (1) - the number 4.

NPAR (2) - the number of plane or axisymmetric elements.

NPAR (3) - the number of different materials. Default is 1. This is also the maximum material number occurring.

NPAR (4) - maximum number of temperature cards associated with any material. Default is 1. This is explained more fully below.

NPAR (5) - structure type indicator. An axisymmetric, plane strain or plane stress

structure is indicated by 0, 1 or 2 respectively.

NPAR (6) - incompatible mode indicator. If nonzero then incompatible modes will be suppressed when element stiffnesses are generated. If the structure is axisymmetric incompatible modes should be suppressed.

##### b. Data Defining Material Properties

With each material there is associated  $1+2 * NTC(MAT)$  cards.

Card No. 1

FORMAT (2I5, 2F10.0)

READ, MAT, NTC(MAT), WT(MAT), WANG(MAT)

MAT - material identification number.

NTC(MAT) - the number of temperature cards defining this material. The default is 1.

WT(MAT) - the weight density of this material.

WANG(MAT) - the angle of anisotropy with respect to the Y or R axis. This is explained more fully below (see note 1).

$2 * NTC(MAT)$  cards, defining the mechanical and thermal properties of this material as a function of temperature. Each pair of cards is as follows:

FORMAT (8F10.0/3F10.0)

READ , TEMP, EN, ES, ET, RNUNS, RNUNT, GNS, HAN, HAS, HAT.

TEMP - temperature at which material has the following properties.

EN - Youngs modulus in N-direction (see below).

ES - Youngs modulus in the S-direction.

ET - Youngs modulus in the T-direction.

RNUNS - Poissons's ratio associated with N-S directions.

RNUNT - Poissons's ratio associated with N-T directions.

RNUST - Poissons's ratio associated with S-T directions.

GNS - shear modulus in N-S direction.

HAN - coefficient of thermal expansion in N direction.

HAS - coefficient of thermal expansion in S direction.

HAT - coefficient of thermal expansion in T direction.

96. Note 1. In the isotropic case,  $EN = ES = ET = E$ ,  $RNUNS = RNUNT = RNUST = RNU$ ,  $GNS = E/2(1 + RNU)$  and  $HAN = HAS = HAT = HA$ . In the general case, orthotropic temperature dependent material properties are allowed. The cards read in above provide the properties versus temperature table. Assuming that nodal point temperatures have been input the element temperature is found by averaging the temperature of the nodal points. The appropriate mechanical properties of this element are then calculated by doing a linear interpolation from the mechanical properties versus temperature tables. The graph of mechanical properties versus temperature is assumed to be constant at temperatures lower than the lowest tabulated temperatures and at temperatures higher than the highest tabulated temperatures. Figure B-17 defines the principal material axis N and S of the anisotropic material. The direction T is out of the paper.

#### c. Element Specification

Each non-generated element has associated with it  $1 + NUMPC$  input cards (an element card and  $NUMPC$  pressure cards associated with the element). Elements must be input in ascending order. Omitted elements are generated as described below.

Element Card

FORMAT (10I5, 2F10.0)

READ, M, (IE(I), I=1,4), MAT, NCUT, NUMPC, NS, KG, REFT, THICK

M - the element number

IE( ) - an array of length four which contains the nodal numbers defining the element. These must be in counterclockwise order. If  $IE(3) = IE(4)$  or if  $IE(4) = 0$  or blank then the element is assumed to be triangular.

MAT - the material number of the element. The default value is 1.

NCUT - the cut number associated with the element. The default value is  $NPROB + 1$  (ie the element will never be removed).

NUMPC - the number of element sides that carry distributed pressure and shear loads. Also the number of cards that follow this card and carry distributed load information. The maximum value for NUMPC is 4 (Note 1).

NS - stress point calculation indicator. Stresses can be calculated at the centroid and at mid-points of element sides depending on the value of this parameter. See Fig B-18 to B-20 for further information.

KG - element generation parameter. Default value is 1. This is more fully described below (Note 2).

REFT - the reference temperature associated with the element.

THICK - element thickness. This only has meaning in the plane stress case.

If NUMPC is greater than zero then NUMPC cards follow:

Pressure cards

FORMAT (I5, 4F10.0)

READ, J, PRES(1,J), PRES(2,J), SHEAR(1,J), SHEAR(2,J), where

J - the side number of the element. Side IE(1)-IE(2) has side number 1, IE(2)-IE(3) side number 2, IE(3)-IE(4) side number 3 and IE(4)-IE(1) side number 4 assuming element is a quadrilateral (for triangular element IE(3)-IE(1) is side 3).

PRES(1,J) - pressure at first node of side J.

PRES(2,J) - pressure at second node of side J.

SHEAR(1,J) - shear at first node of side J.

SHEAR(2,J) - shear at second node of side J.

97. Note 1. Distributed loads. It is assumed that pressures and shears vary linearly over the side of an element. Shear stress is considered positive if it tends to turn an element counterclockwise.

98. Note 2. Element Generation. Suppose that the previous card contained NOLD, IO, JO, KO, LO, MATO, NUMPCO, NSO, KGO, TO, THICKO and that the current card contains NNEW, IN, JN, KN, LN, MATN, NUMPCN, NSN, KGN, TN, THICKN, then if NNEW is

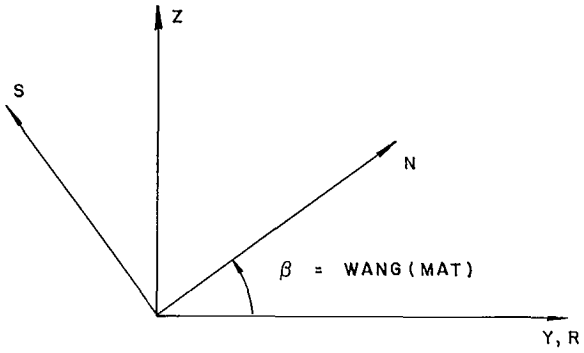

Fig B-17 - Principal material axis N-S.

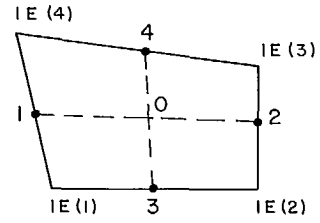

Fig B-18 - Stress calculation points for a quadrilateral.

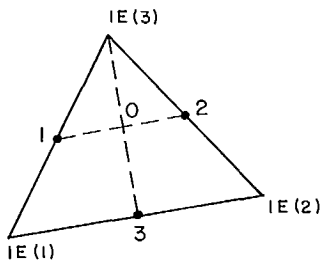

Fig B-19 - Stress calculation points for a triangle.

NS	STRESS POINTS
1	none
0	0
8	0,1
16	0,1,2,3
20	0,1,2,3,4

Fig B-20 - Table of NS values vs stress points.



greater than NOLD + 1 all information for elements NOLD + 1, ----, NNEW - 1 is generated as follows. Consider element NOLD + M=N then the card generated for this is N, I, J, K, L, MATO, NCUTO, NUMPCO, NSO, KG, THICKO where

$I = IO + M * KGN$  (Note KGN not KGO is used for generation)

$J = JO + M * KGN$

$K = KO + M * KGN$

$L = LO + M * KGN$

KG is set to zero to denote a generated element. Distributed loads (if any) are assumed identical to that of previous card.

#### D. Boundary Element Data

If no boundary elements are used (ie NELTYP on the problem control card equals 1) then no cards appear here.

##### a. Element Parameter Card

FORMAT (2I5)

READ , NPAR(1), NPAR(2)

NPAR(1) - element type indicator. It equals 7 for a boundary element.

NPAR(2) - the total number of boundary elements.

##### b. Boundary Element Specification

Element cards must be in ascending sequence starting with element 1 and ending with element NPAR(2). Omitted elements are generated as described below.

FORMAT (5I5, 2E15.6)

READ , NEL, NP, NI, KN, NCUT, SD, TRACE

where

NEL - element number.

NP - node number of node where element is located.

NI - node number of node that with NP defines the axial direction of the boundary element. Direction NP to NI is considered positive. If NI is zero or blank then direction defined by previous input card is used.

KN - element generation parameter. Default value is 1. This is described more fully below.

NCUT - cut number associated with this element. If zero or blank, it is taken to

be NPROB + 1, ie it is never removed.

SD - specified displacement. Note that the direction from "location" node to "direction" node is considered positive.

TRACE - axial stiffness of element. If zero or blank it is taken to be  $10^{10}$ .

99. Generation. (a) In many problems a given displacement constraint direction remains fixed for a number of elements. To avoid having to introduce (possibly artificial) direction nodes for all these elements, the following generation feature has been built in. If the direction node is blank or zero then the direction defined by the last previous card with a nonzero entry is used. (b) Omitted elements are also generated. In this case the location nodes of generated elements are found by incrementing the location node of the previous card by increasing multiples of the element generation parameter of the current card. Element direction, cut number, specified displacement and axial stiffness are all as on the previous card.

#### E. Concentrated Nodal Load Input

If no concentrated load data occurs then a blank card must appear here. Only nonzero concentrated nodal load data need be input. Data must appear in nondecreasing nodal number sequence. A node is repeated for each load case with nonzero nodal load at this node. These load cases, for a given node, can be in any order.

FORMAT (2I5, 2F10.4)

READ , N,L, (R(I), I = 1,2)

N - the nodal number of node where concentrated force appears.

L - the load case. Possible values of L are from 1 to LL.

R(1) - Y or R component of force.

R(2) - Z component of force.

#### F. Load Multipliers

LL (the number of load cases) cards must appear here. Each card defines one load vector as the sum of the corresponding concentrated loads and as a linear combination of the load multipliers and the thermal stress loads, distributed pressure and shear loads, initial stress loads

and gravity loads respectively.

FORMAT (6F10.0)

READ , ((STR(I,L), I = 1,6), L = 1, LL)

STR(1,L) - the thermal stress multiplier for load case L.

STR(2,L) - the Y or R component multiplier of the distributed load for the load case L. This also multiplies the Y or R component of the boundary element loads.

STR(3,L) - the Z component multiplier of the distributed load for load case L. This also multiplies the Z component of the boundary forces loads.

STR(4,L) - the initial stress multiplier for the load case L.

STR(5,L) - the Y or R component multiplier of the gravity load for the load case L.

STR(6,L) - the Z component multiplier of the gravity load for load case L.

#### SAP2D Output

100. Printer Output (fortran logical unit No. 6). Depending on the values of the printer control parameters, the input data, displacement output and stress output can be printed. Certain additional information, eg the number of blocks in which the global stiffness matrix is subdivided, the number of equations in a block, the maximum bandwidth, the central processor time spent in various phases of SAP2D, is also printed.

101. SAPOUT Output (fortran logical unit No. 10). In order to facilitate graphical representation of stress and displacement output or to make certain stability computations, certain data is written onto an auxiliary storage device (disk or tape). There are 2 + 2 \*NPROB (where NPROB is the number of subproblems) files written onto the SAPOUT storage device.

##### a. File 1. Coordinates of Nodal Points

Consists of one record header - FORMAT (1H , 3I10, 8A10). Contents of header are NC, NC1, NUMNP, HED. Here NC = 0, NC1 = 1, NUMNP is the number of nodal points and HED is an eight word vector containing the SAP2D title (the first input card). The rest of the file contains the Y and Z coordinates of all (NUMNP) nodal

points. (Y(I), Z(I), I = 1, NUMNP) FORMAT (1H , 8E15.7)

##### b. File 2. Element Data

One record header - FORMAT(1H , 3I10, 8A10), Contents of header NC, NC1, NUME, HED. Here NC = 0, NC1 = 2, NUME is the number of plane elements (boundary elements are not output) and HED is the eight word title as before. The rest of the file contains NUME records with FORMAT(1H , 7I10). Contents of each record is N, (IX(I), I = 1,4), MAT, NCUT. N is the element number, IX(1),---, IX(4) the nodal points defining the element, MAT the material number of the element and NCUT the cut number associated with the element.

102. These 2 files are followed by 2 \* NPROB files, ie for each subproblem (1 to NPROB) there is associated one file containing the nodal displacements and a second file containing the element stresses.

103. The displacement file associated with subproblem NC is as follows: One record header FORMAT (1H , 4I10, 8A10) with contents of NC, NC1, NNP, LL, HED. NC is the subproblem number, NC1 = 1, NNP equals the number of nondeleted nodal points, LL is the number load cases and HED is the 8 word title. The header is followed by LL \* NNP records containing the displacements. The LL displacement associated with a nodal point are grouped together. The nodal points with associated displacements are stored in reverse order, ie the non-deleted nodal point with the largest nodal point number occurs first and non-deleted nodal point with the smallest nodal point number occurs last. The contents of LL records associated with node N, FORMAT(1H , I10, I5, 2E15.7), are (N, L, DY(L), DZ(L), L = 1, LL). N is the nodal point number, L the load number (1 to LL), DY(L) and DZ(L) the Y(or R) and Z displacements associated with load case L.

104. The stress file associated with subproblem NC is as follows. One record header FORMAT(1H , 4I10, 8A10) with contents of NC, NC1, NNUME, LL, HED. NC is the subproblem number, NC1 = 2, NNUME is the number of nondeleted elements, LL is the number of load cases and HED is the 8 word

title associated with the problem. The header is followed by records giving the stresses in each nondeleted element for each load case. With each element is associated NS \* LL records where NS is the number of stress calculation points in the element and LL the number of load cases.

105. Each record, FORMAT (1H , 2I5, A3, 9E13.7), contains MM, L, STRLAB, (SIG(I), I=1, 7), YC, ZC. STRLAB is a 3 character label defining the stress calculation point (for stress at the centroid STRLAB = 3HCEN). SIG(1), SIG(2), SIG(3) and SIG(4) are SIGYY (or SIGRR), SIGZZ, SIGXX(or SIGTT) and SIGYZ(or SIGRZ) respectively. SIG(5) and SIG(6) are the principal stresses and SIG(7) is the angle in degrees that the major principal stress makes with the Y (or R) axis. YC and XC are the Y(or R) and Z coordinates of the centroid. For midside locations the stresses come out in local coordinates (see the stress writeup). No stresses are output for the boundary elements.

#### Storage Requirements

106. The user must change the length of blank common in SAP2D to that required by his problem. This is done by changing the two cards SAP2D.15 and SAP2D.16 in the main program of SAP2D to:

```
COMMON A('MTOT')
MTOT = 'MTOT'
```

107. MTOT must be greater than or equal to the following quantities:

- a.  $5 * \text{NUMNP} + 3 * \text{NUMMAT} + 11 * \text{NUMMAT} * \text{NUMTC}$
- b.  $2 * \text{NUMNP} + (\text{NEQB} + 6) * \text{LL}$
- c.  $2 * \text{NEQB} * (\text{MBAND} + \text{LL}) + \text{NEQB}$
- d.  $\text{NEQB} + (\text{MBAND} + \text{LL}) + \text{NEQB} + \text{NEQB} * \text{LL} * (2 + (\text{MBAND} - 1)/\text{NEQB})$
- e.  $3 * \text{NUMNP} + 2 * \text{LL} + \text{NEQB} * \text{LL}$
- f.  $\text{NEQB} * \text{LL} + \text{NEQ} + 12$

If temperature effects are considered, 'NUMNP' must be added to (c) and (b).

NUMNP - the number of nodal points.

NUMMAT - the number of materials.

NUMTC - the maximum number of temperature cards associated with any material.

NEQB - the number of equations in a block (see below).

LL - the number of load cases (number of right-

hand sides).

MBAND - the half band width of the global stiffness matrix.

NEQ - the total number of equations.

108. Note that  $\text{NEQ} \leq 2 * \text{NUMNP}$  and  $\text{MBAND} \leq 2 * \text{NPDIF} + 2$ , where NPDIF is the maximum nodal point difference in any element. NEQB must be at least one. For efficient running of program make NEQB = MBAND if possible.

109. Assuming no temperature effects, number of load cases LL = 1 and NEQB = MBAND, take:  $\text{MTOT} \geq \text{MAX}(5 * \text{NUMNP} + 14 * \text{NUMMAT}, 2 * \text{MBAND} ** 2 + 3 * \text{MBAND})$ .

110. On the CDC 6000 series of computers or the CYBER series the central memory requirements are: CM = 26400 + MAX(6500, MTOT) with no boundary elements, ie routines BOUND and CLAMP not loaded, or CM = 27000 + MAX (6600, MTOT) with routines BOUND and CLAMP loaded.

#### Example

111. An example was devised to illustrate SAP2D input. The problem with its finite element discretization is shown in Fig B-21. Note that since roller constraints had to be imposed in directions other than the global directions it was necessary to make use of boundary elements. The input required for this example is shown in Fig B-22.

60 DEGREE AXISYMETRIC SLOPE

#### Some Problems

112. When carrying out a 2-d analysis the user must choose between approximating the actual geometry either by a plane strain or axisymmetric model.

113. An ever present problem on modelling mine geometry is the size of the problem. The only reasonable boundary conditions that can be assumed are that the excavation displacements or the excavation stresses are zero in the rock mass at points a large distance from the excavation. However, computer costs go up rapidly as we increase the number of nodal points and the number of elements. The user must therefore compromise between error and computer costs. A rule of thumb

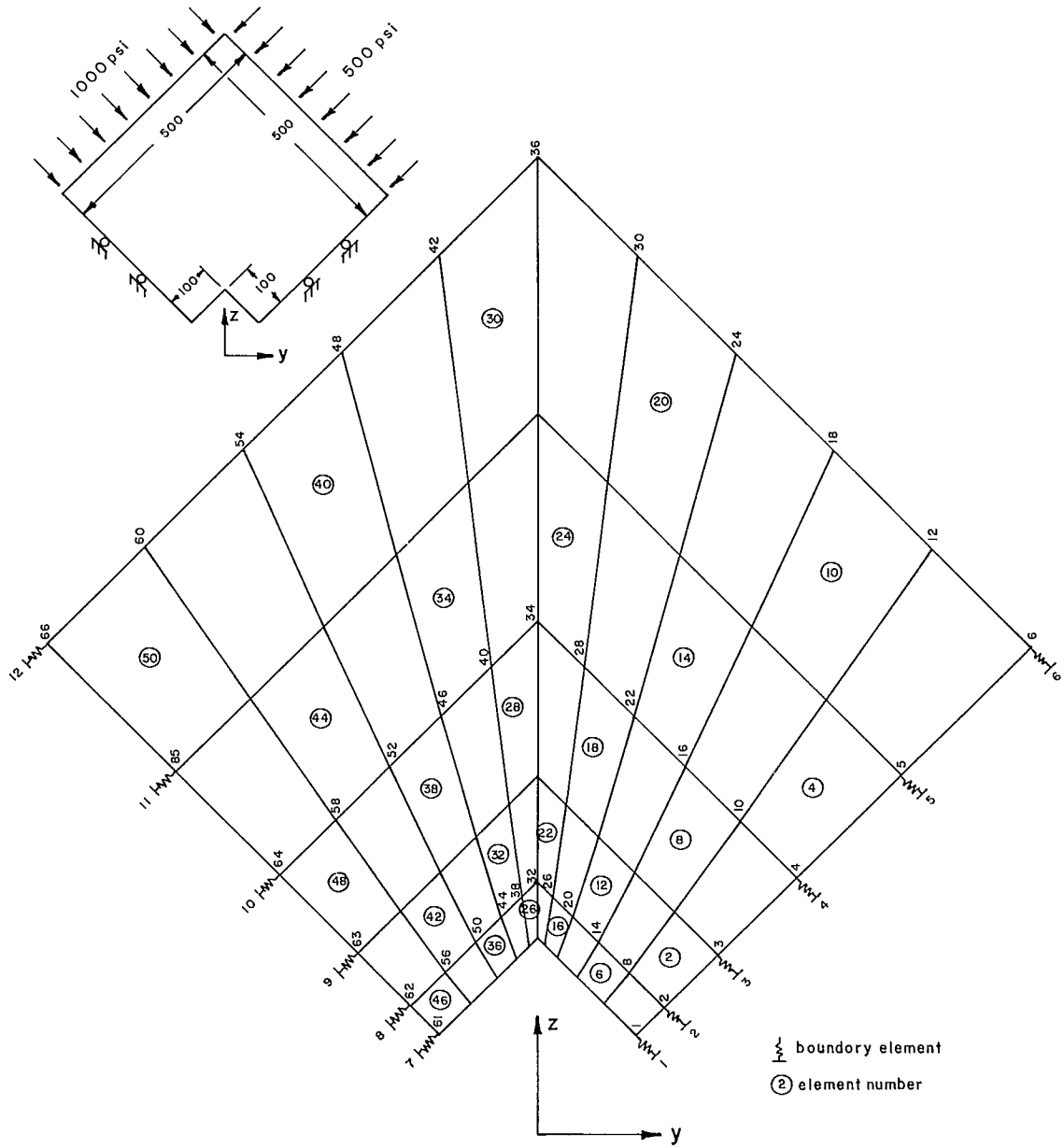

Fig B-21 - SAP2D example.

EXAMPLE - SAP2D WITH BOUNDARY ELEMENTS							
66	2	1	1	1	1	1	0 0 12.
1	0	0		70.711		70.711	0
2	0	0		91.075		91.075	0
3	0	0		129.542		129.542	0
4	0	0		186.110		186.110	0
5	0	0		260.780		260.780	0
6	0	0		353.553		353.553	0
7	0	0		47.518		93.904	0
8	0	0		65.619		116.530	0
9	0	0		98.203		160.880	0
10	0	0		145.267		226.954	0
11	0	0		206.814		314.753	0
12	0	0		282.842		424.276	0
13	0	0		28.850		112.571	0
14	0	0		43.784		138.364	0
15	0	0		69.579		189.502	0
16	0	0		106.235		265.988	0
17	0	0		153.753		367.820	0
18	0	0		212.132		494.999	0
19	0	0		14.708		126.713	0
20	0	0		25.569		156.577	0
21	0	0		43.671		215.410	0
22	0	0		69.013		303.212	0
23	0	0		101.597		419.982	0
24	0	0		141.421		565.722	0
25	0	0		5.091		136.330	0
26	0	0		10.974		171.170	0
27	0	0		20.478		238.602	0
28	0	0		33.602		338.625	0
29	0	0		50.346		471.239	0
30	0	0		70.711		636.445	0
31	0	0		0.000		141.421	0
32	0	0		0.000		182.143	0
33	0	0		0.000		259.079	0
34	0	0		0.000		372.228	0
35	0	0		0.000		521.591	0
36	0	0		0.000		707.168	0
37	0	0		-5.091		136.330	0
38	0	0		-10.974		171.170	0
39	0	0		-20.478		238.602	0
40	0	0		-33.602		338.625	0
41	0	0		-50.346		471.239	0
42	0	0		-70.711		636.445	0
43	0	0		-14.708		126.713	0
44	0	0		-25.569		156.577	0
45	0	0		-43.671		215.410	0
46	0	0		-69.013		303.212	0
47	0	0		-101.597		419.982	0
48	0	0		-141.421		565.722	0
49	0	0		-28.850		112.571	0
50	0	0		-43.784		138.364	0
51	0	0		-69.579		189.502	0
52	0	0		-106.235		265.988	0
53	0	0		-153.753		367.820	0
54	0	0		-212.132		494.999	0
55	0	0		-47.518		93.904	0
56	0	0		-65.619		116.530	0
57	0	0		-98.203		160.880	0
58	0	0		-145.267		226.954	0
59	0	0		-206.814		314.753	0
60	0	0		-282.842		424.276	0
61	0	0		-70.711		70.711	0
62	0	0		-91.075		91.075	0
63	0	0		-129.542		129.542	0
64	0	0		-186.110		186.110	0
65	0	0		-260.780		260.780	0
66	0	0		-353.553		353.553	0

Fig B-22 - Input for SAP2D example (Fig B-21).



that has been much used in this regard is that stresses and displacements in the vicinity of the excavation are in error by less than 10% if the fictitious outer boundary is at a distance of five times the excavation size.

114. Another recurrent problem, after assuming that linear elasticity will give at least a first order approximation, is the lack of precise in situ values for the elastic constants. This points to one advantage of using stress boundary conditions. In this case the resulting stress field will be independent of the elastic constants if the rock mass is assumed to be homogeneous. Hence it is possible to compare a series of designs using somewhat arbitrary values for the elastic constants.

115. The state of initial stress that existed prior to performing the excavation is required. This data is particularly difficult to obtain if the rock weight density varies significantly over the structure and a simple analytically defined initial stress field cannot be assumed.

#### Gravity Loading

116. The model described here was actually one of a series of models used in a parametric study of the influence of various parameters such as slope angle, slope height and pit width on the stresses and displacements in the vicinity of the slope. Figure B-23 shows the model chosen for analysis. The extent of the model, the boundary conditions, the material constants and the initial stress field are all shown on this figure. Figure B-24 gives the zone diagram and Fig B-25 the associated key diagram of the model. In Fig B-24 the boundary of the region of interest or the 'critical' region (ie the region next to the excavation in which we are primarily interested) is denoted by a dashed line. Figure B-26 shows the finite element mesh produced by MSHGEN and MSHPLT. There are 1802 nodal points and 1716 elements. The elements in the critical region have been magnified in Fig B-27, and the nodal and element numbers plotted. This was also produced by MSHPLT.

117. The mesh produced by MSHGEN was merged

with additional card input in SAP2DC to produce a SAP2D input file. SAP2D was run using this data. The resulting stiffness matrix had 3516 equations and a half bandwidth of 71. The computer costs to run SAP2D on a CDC CYBER 74 was approximately \$80 in 1975.

#### Displacements

118. SAP2D produces tables of nodal point numbers versus R and Z-displacements on the printer. Figure B-28 shows the first page of printer displacement output for the 60 degree slope. SAP2D outputs the displacements in reverse nodal point order.

119. The obvious way of representing displacements in two dimensions is by plotting the displacements as vectors. The displacements are suitably scaled for easy visual inspection. Figure B-29 shows an example of such a vector plot of excavation displacements over the critical region.

#### Stresses

120. SAP2D prints tables of element numbers versus stress field. The stress field for an axisymmetric structure is made up of  $\sigma_r$ ,  $\sigma_z$ ,  $\sigma_\theta$  and  $\sigma_{rz}$ . The principal stresses in the r-z plane are also calculated and printed as well as the angle with respect to the r-axis of the major principal stress (most positive one). Figure B-30 shows the first page of printer output for the 60 degree axisymmetric slope. As well as printing SAP2D stress, the nodal point coordinates, element data, the displacements and the stresses are stored on disk and tape for possible future graphical representation.

121. Figure B-31 shows an example of a plot of stress in the critical region of the 60 degree slope. Vectors are drawn without arrows and compressive stresses are distinguished from tensile stresses by having a bar across the vector. Unfortunately, such a plot can become quite cluttered when the element density is high. An additional drawback is that tensile stresses which are usually small (although still important) compared to compressive stresses are difficult to

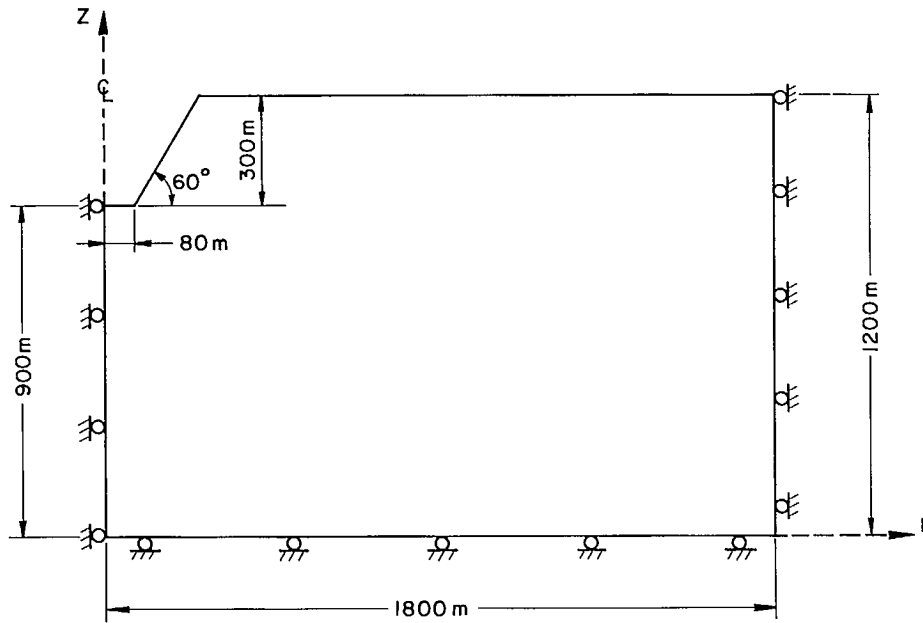

Material constants assumed :

Young's modulus	$70.3 \times 10^6$ kPa ( $10.0 \times 10^6$ psi)
Poisson's ratio	.25
Weight density	$27000$ N/m <sup>3</sup> (.0995 lb/in <sup>3</sup> )

Initial stress field assumed (kilopascals)

$$\sigma_z = -27(1200 - Z) \quad (Z \text{ in meters})$$

$$\sigma_r = \sigma_\theta = \nu / (1 - \nu) \sigma_z = \sigma_z / 3$$

Fig B-23 - 60 degree axisymmetric slope with gravity loading.



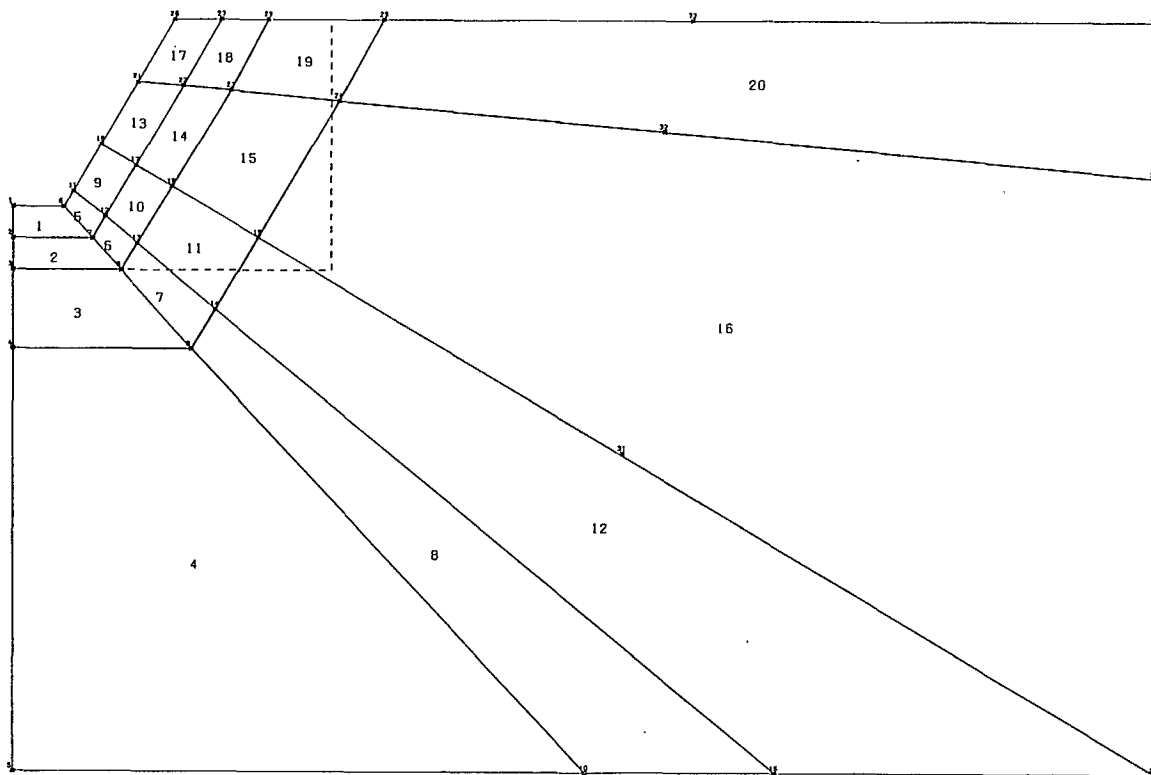

Fig B-24 - Zone diagram of 60 degree axisymmetric slope. (\*'s denote specified points, dashed line is boundary of critical region).

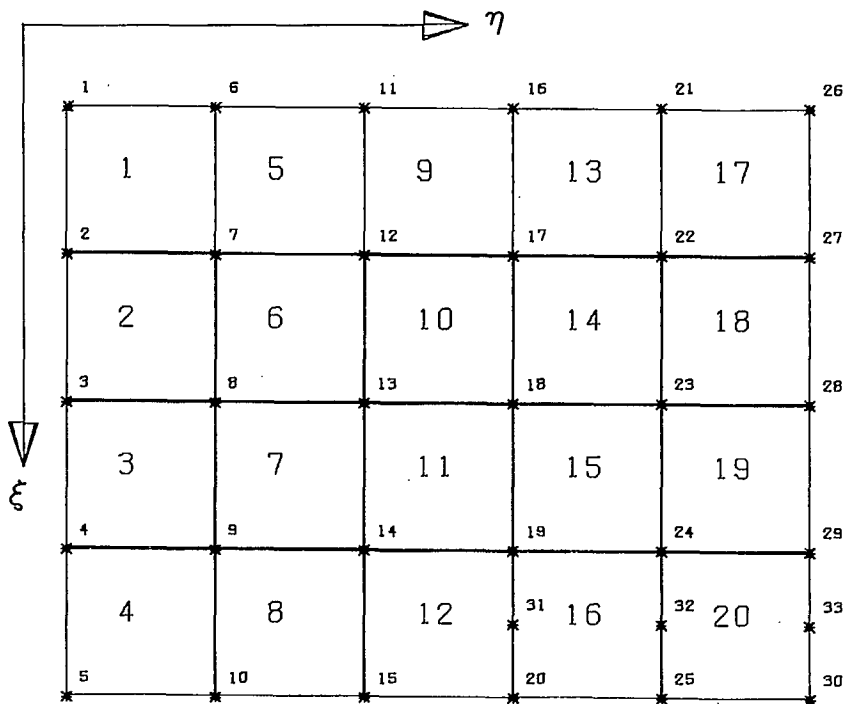

Fig B-25 - Key diagram of 60 degree axisymmetric slope.

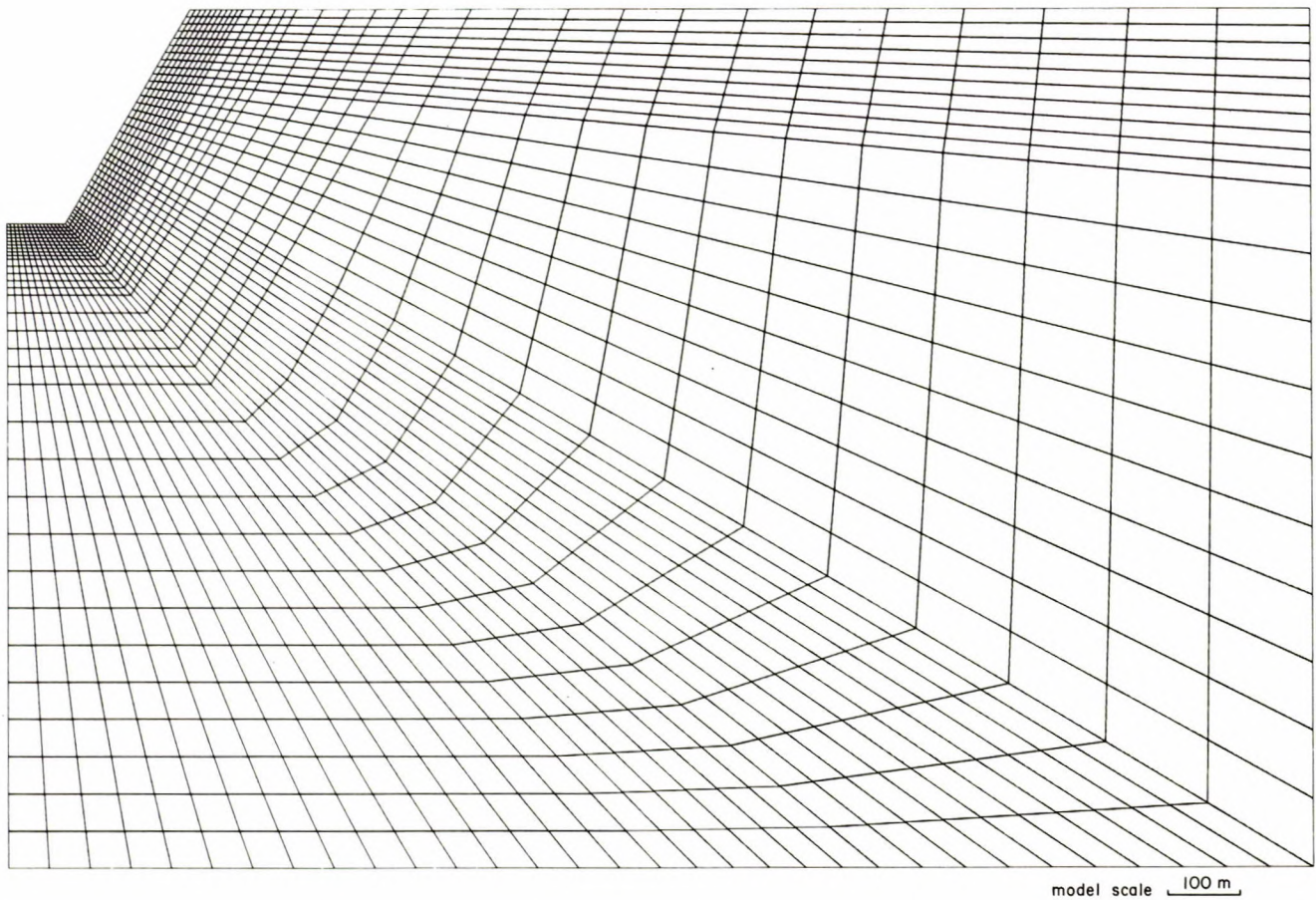

Fig B-26 - Finite element discretization of 60 degree axisymmetric slope.

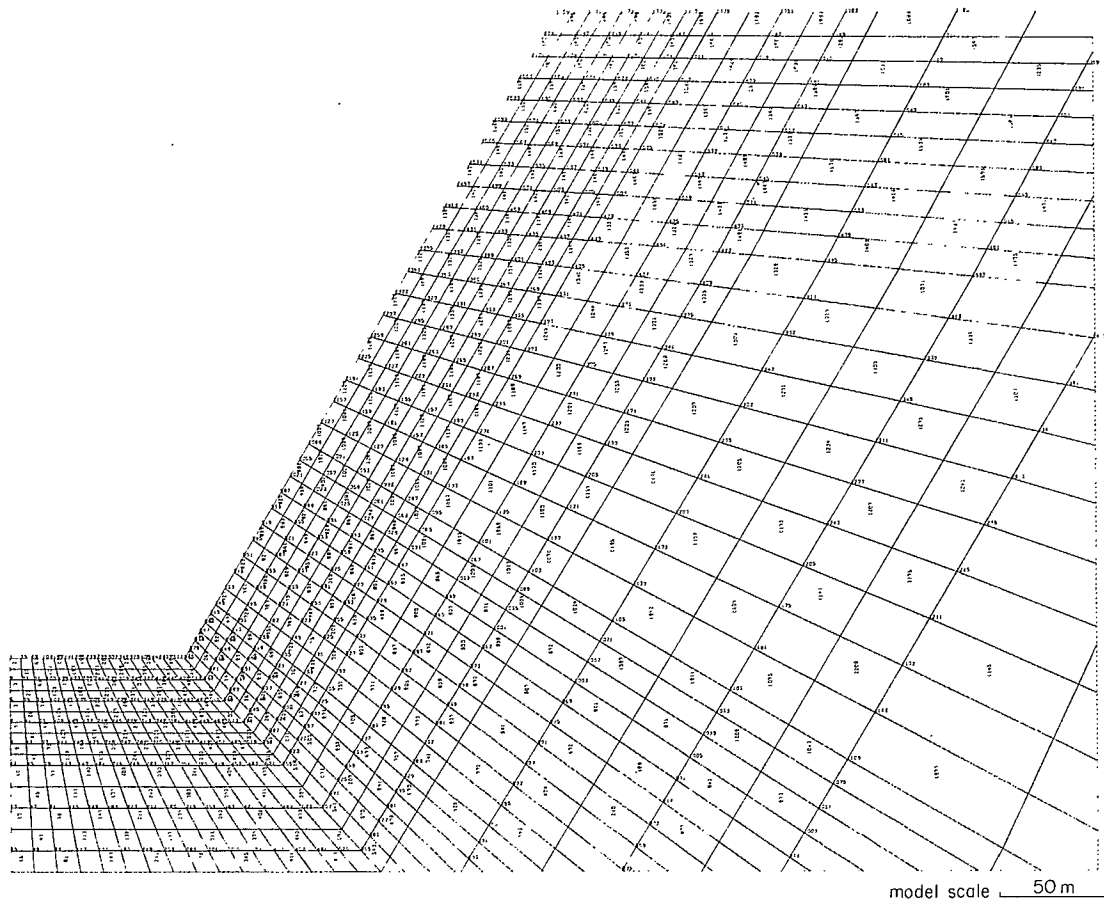

Fig B-27 - Finite element discretization of critical region with nodal and element numbers.

NOOE	LOAD	N O D A L   D I S P L A C E M E N T S (CM)	
		R-DISPLACEMENT	Z-DISPLACEMENT
1802	1	0.	-1.6632751E-02
1801	1	6.2010573E-03	-1.5854052E-02
1800	1	1.2939967E-02	-1.2680636E-02
1799	1	2.0470337E-02	-7.2303044E-03
1798	1	2.9048014E-02	7.1929472E-04
1797	1	3.8893539E-02	1.1480252E-02
1796	1	5.0197640E-02	2.5431763E-02
1795	1	6.3123499E-02	4.3000012E-02
1794	1	7.7809535E-02	6.4641775E-02
1793	1	9.4369154E-02	9.0827848E-02
1792	1	1.1288276E-01	1.2202124E-01
1791	1	1.3338071E-01	1.5864730E-01
1790	1	1.5580216E-01	2.0105961E-01
1789	1	1.7979129E-01	2.4947141E-01
1788	1	1.9702664E-01	2.8454942E-01
1787	1	2.1631842E-01	3.2534137E-01
1786	1	2.3790608E-01	3.7300638E-01
1785	1	2.6204693E-01	4.2918696E-01
1784	1	2.8865926E-01	4.9619899E-01
1783	1	3.0658126E-01	5.2637167E-01
1782	1	3.1301648E-01	5.5911667E-01
1781	1	3.2589549E-01	5.9459820E-01
1780	1	3.3914124E-01	6.330727E-01
1779	1	3.5262493E-01	6.7489301E-01
1778	1	3.5947122E-01	7.1989243E-01
1777	1	3.6633821E-01	7.6888577E-01
1776	1	3.7317184E-01	8.2206304E-01
1775	1	3.7991860E-01	8.7940529E-01
1774	1	3.8651159E-01	9.40939815E-01
1773	1	3.9286365E-01	1.00939815E-01
1772	1	3.9885960E-01	1.07940529E-01
1771	1	4.0434675E-01	1.1523752E-01
1770	1	4.0912595E-01	1.22996603E-02
1769	1	4.1287359E-01	-1.22996603E-02
1768	1	0.	-1.6204378E-02
1767	1	5.8368704E-03	-1.2996603E-02
1766	1	1.2197764E-02	-7.4844849E-03
1765	1	1.9344446E-02	5.6248916E-04
1764	1	2.7508199E-02	1.1473056E-02
1763	1	3.6897356E-02	2.5644194E-02
1762	1	4.7689581E-02	4.3523403E-02
1761	1	6.0036002E-02	6.5592629E-02
1760	1	7.4061913E-02	9.2350902E-02
1759	1	8.9864385E-02	1.2429570E-01
1758	1	1.0750370E-01	1.6188920E-01
1757	1	1.2698769E-01	2.0556163E-01
1756	1	1.4818731E-01	2.5535922E-01
1755	1	1.7102498E-01	2.9124967E-01
1754	1	1.8701144E-01	3.3297530E-01
1753	1	2.0479800E-01	

Fig B-28 - Sample of SAP2D printer displacement output.

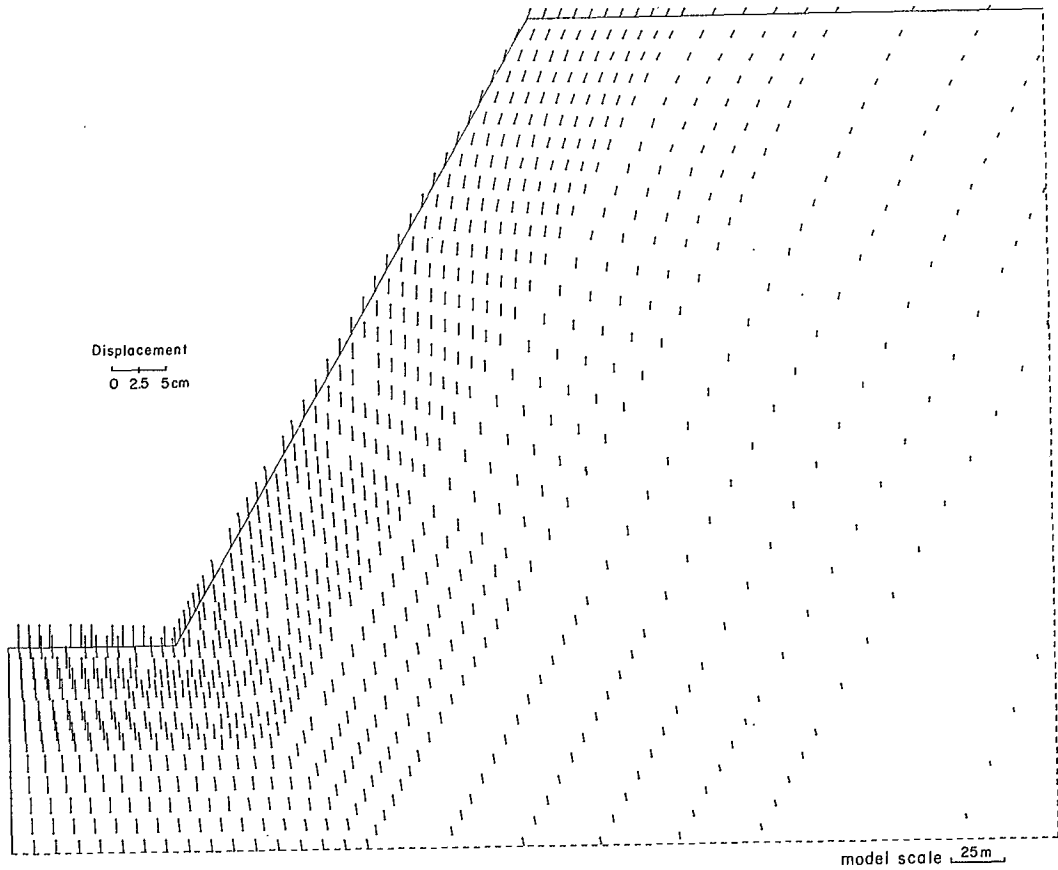

Fig B-29 - Excavation displacement vector plot in critical region.

STRESS OUTPUT FOR 2-D PLANE OR AXISYMMETRIC ELEMENTS									
CENTRE STRESSES IN Y-Z COORDS, BOUNDARY STRESSES NORMAL AND PARALLEL TO THE STRESSES									
EL.NO.	LOAD	FACE	SIG-YY SIG-RR	SIG-ZZ	SIG-XX SIG-TT	SIG-YZ SIG-RZ	S-MAX	S-MIN	ANGLE
1	1	CEN	5.151317E+01	-6.270911E+01	5.151317E+01	-2.834046E-01	5.815414E-01	-6.943028E-01	-13.188
2	1	CEN	-4.759226E+00	-2.272199E+00	-4.759226E+00	-4.189623E-01	-2.203517E+00	-4.827907E+00	-80.691
3	1	CEN	-9.527974E+00	-4.306882E+00	-9.527974E+00	-5.443819E-01	-4.250725E+00	-3.584131E+00	-84.111
4	1	CEN	-1.382645E+01	-6.713652E+00	-1.382645E+01	-6.860159E-01	-6.648092E+00	-1.389201E+01	-84.541
5	1	CEN	-1.764474E+01	-9.492313E+00	-1.764474E+01	-8.320232E-01	-9.440826E+00	-1.772879E+01	-84.232
6	1	CEN	-2.098908E+01	-1.261438E+01	-2.098908E+01	-9.727173E-01	-1.250289E+01	-2.110057E+01	-83.401
7	1	CEN	-2.388286E+01	-1.603129E+01	-2.388286E+01	-1.100119E+00	-1.588006E+01	-2.403409E+01	-82.173
8	1	CEN	-2.636281E+01	-1.968244E+01	-2.636281E+01	-1.208637E+00	-1.947050E+01	-2.657475E+01	-80.094
9	1	CEN	-2.847390E+01	-2.350290E+01	-2.847390E+01	-1.295153E+00	-2.318576E+01	-2.879110E+01	-76.239
10	1	CEN	-3.026474E+01	-2.742940E+01	-3.026474E+01	-1.358703E+00	-2.688343E+01	-3.081070E+01	-88.109
11	1	CEN	-3.239027E+01	-3.353746E+01	-3.239027E+01	-1.415810E+00	-3.143628E+01	-3.449149E+01	-33.973
12	1	CEN	-3.456917E+01	-4.142316E+01	-3.456917E+01	-1.427760E+00	-3.428365E+01	-4.170866E+01	-11.309
13	1	CEN	-3.619025E+01	-4.900417E+01	-3.619025E+01	-1.385809E+00	-3.604124E+01	-4.935313E+01	-6.124
14	1	CEN	-3.749518E+01	-5.616521E+01	-3.749518E+01	-1.322204E+00	-3.736221E+01	-5.625818E+01	-4.022
15	1	CEN	-3.850106E+01	-6.286962E+01	-3.850106E+01	-1.239642E+00	-3.843817E+01	-6.293251E+01	-2.905
16	1	CEN	-4.011771E+01	-7.380376E+01	-4.011771E+01	-1.087446E+00	-4.008269E+01	-7.384682E+01	-1.447
17	1	CEN	-4.210525E+01	-8.709327E+01	-4.210525E+01	-8.558603E-01	-4.208724E+01	-8.711110E+01	-1.140
18	1	CEN	-4.403495E+01	-9.871134E+01	-4.403495E+01	-7.443252E-01	-4.402482E+01	-9.872147E+01	-7.760
19	1	CEN	-4.598954E+01	-1.091658E+02	-4.598954E+01	-6.278860E-01	-4.598330E+01	-1.091720E+02	-5.609
20	1	CEN	-4.798461E+01	-1.188023E+02	-4.798461E+01	-5.383254E-01	-4.798052E+01	-1.188064E+02	-4.430
21	1	CEN	-5.120869E+01	-1.326850E+02	-5.120869E+01	-4.372522E-01	-5.120634E+01	-1.326873E+02	-3.307
22	1	CEN	-5.557919E+01	-1.498431E+02	-5.557919E+01	-3.436384E-01	-5.557794E+01	-1.498443E+02	-2.209
23	1	CEN	-6.003846E+01	-1.660521E+02	-6.003846E+01	-2.782056E-01	-6.003773E+01	-1.660528E+02	-1.150
24	1	CEN	-6.455549E+01	-1.816618E+02	-6.455549E+01	-2.296522E-01	-6.455504E+01	-1.816622E+02	-0.112
25	1	CEN	-6.911148E+01	-1.968691E+02	-6.911148E+01	-1.918006E-01	-6.911120E+01	-1.968693E+02	-0.086
26	1	CEN	-7.369488E+01	-2.117974E+02	-7.369488E+01	-1.609872E-01	-7.369469E+01	-2.117926E+02	-0.007
27	1	CEN	-7.829842E+01	-2.265069E+02	-7.829842E+01	-1.348888E-01	-7.829830E+01	-2.265069E+02	-0.052
28	1	CEN	-8.291745E+01	-2.410614E+02	-8.291745E+01	-1.119387E-01	-8.291737E+01	-2.410615E+02	-0.041
29	1	CEN	-8.754886E+01	-2.554895E+02	-8.754886E+01	-9.099526E-02	-8.754881E+01	-2.554895E+02	-0.031
30	1	CEN	-9.219056E+01	-2.698178E+02	-9.219056E+01	-7.116574E-02	-9.219053E+01	-2.698136E+02	-0.023
31	1	CEN	-9.684106E+01	-2.840500E+02	-9.684106E+01	-5.168509E-02	-9.684109E+01	-2.840501E+02	-0.016
32	1	CEN	-1.014993E+02	-2.982066E+02	-1.014993E+02	-3.183951E-02	-1.014993E+02	-2.982066E+02	-0.009

Fig B-30 - Sample of SAP2D stress output. (Stresses in units of  $10^2$  kilopascals or 14.5 psi).

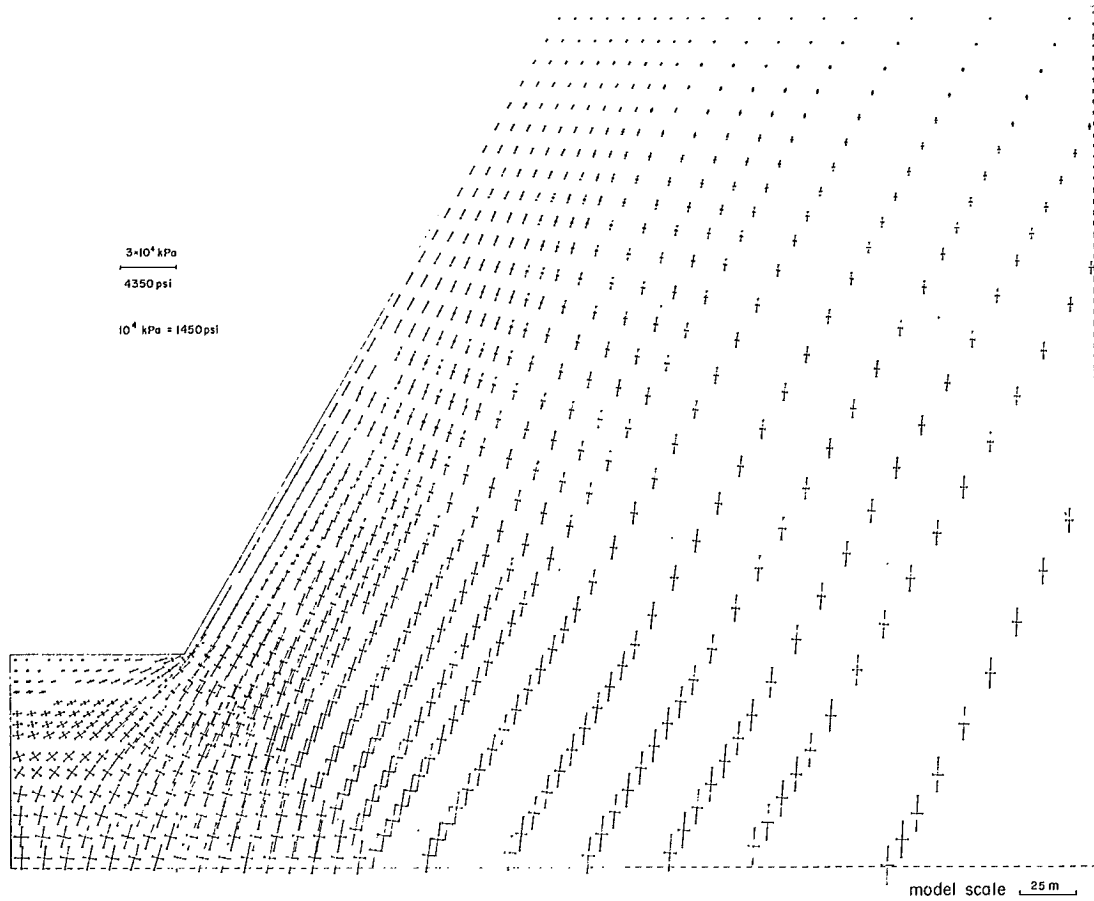

Fig B-31 - Principal stresses plotted as vectors in critical region.

see. To avoid these problems point contour plots of the major and minor principal stresses can be made. Figures B-32 and B-33 give examples of these for the slope problem. The contour lines are hand drawn.

122. Frequently we are interested in some scalar function of the stress that is related to local stability, eg local safety factors or some

yield function. Figure B-34 is an example of such a plot over the critical region of the slope. Here the Drucker-Prager yield function has been plotted with assumed values of cohesion and internal friction. Although the numbers produced may not be too meaningful we still get a convenient approximate ordering of our structure into stability zones.

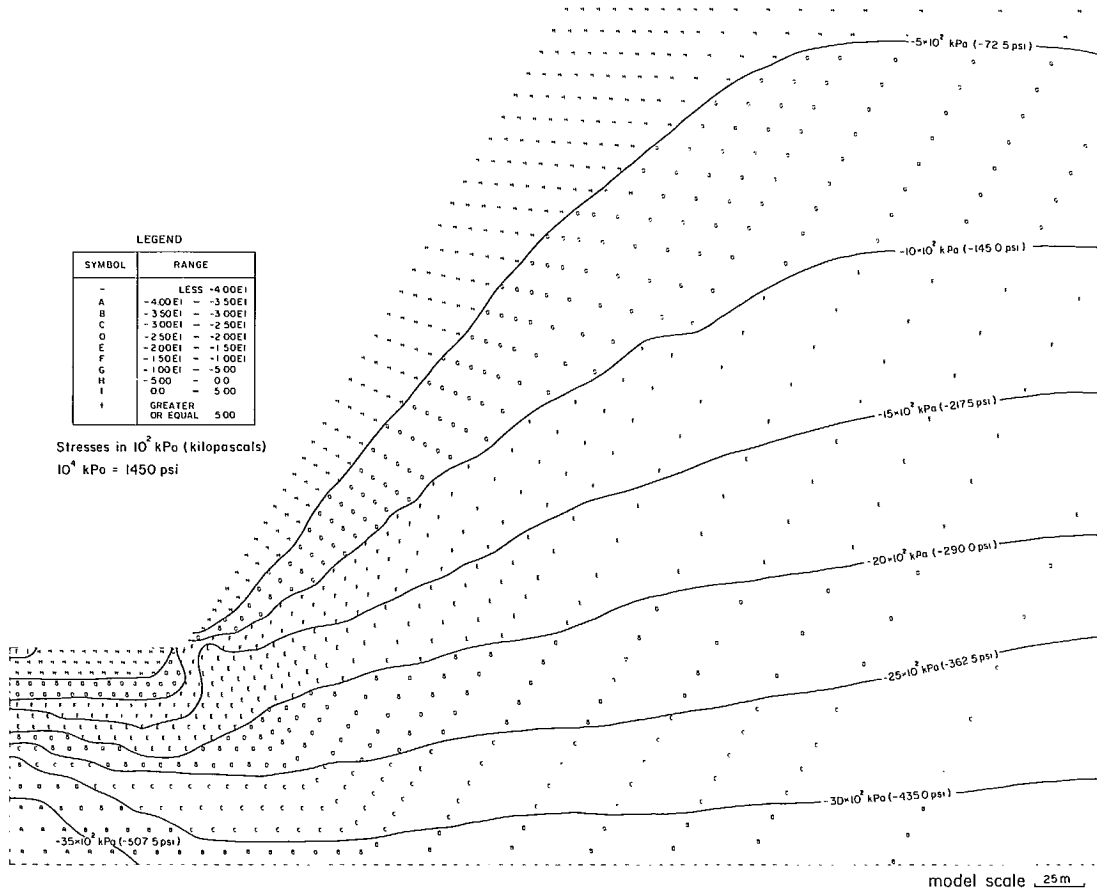

Fig B-32 - Major principal stress point contour plot in critical region.



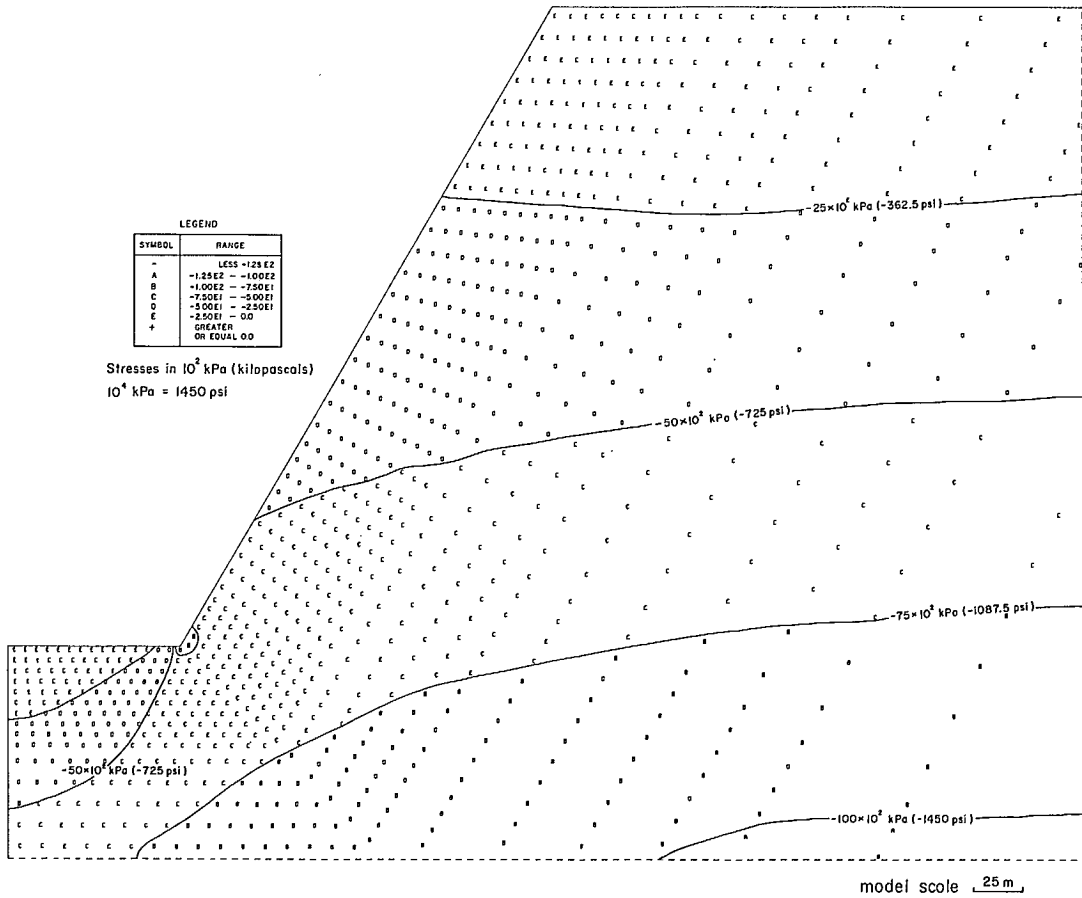

Fig B-33 - Minor principal stress point contour plot in critical region.

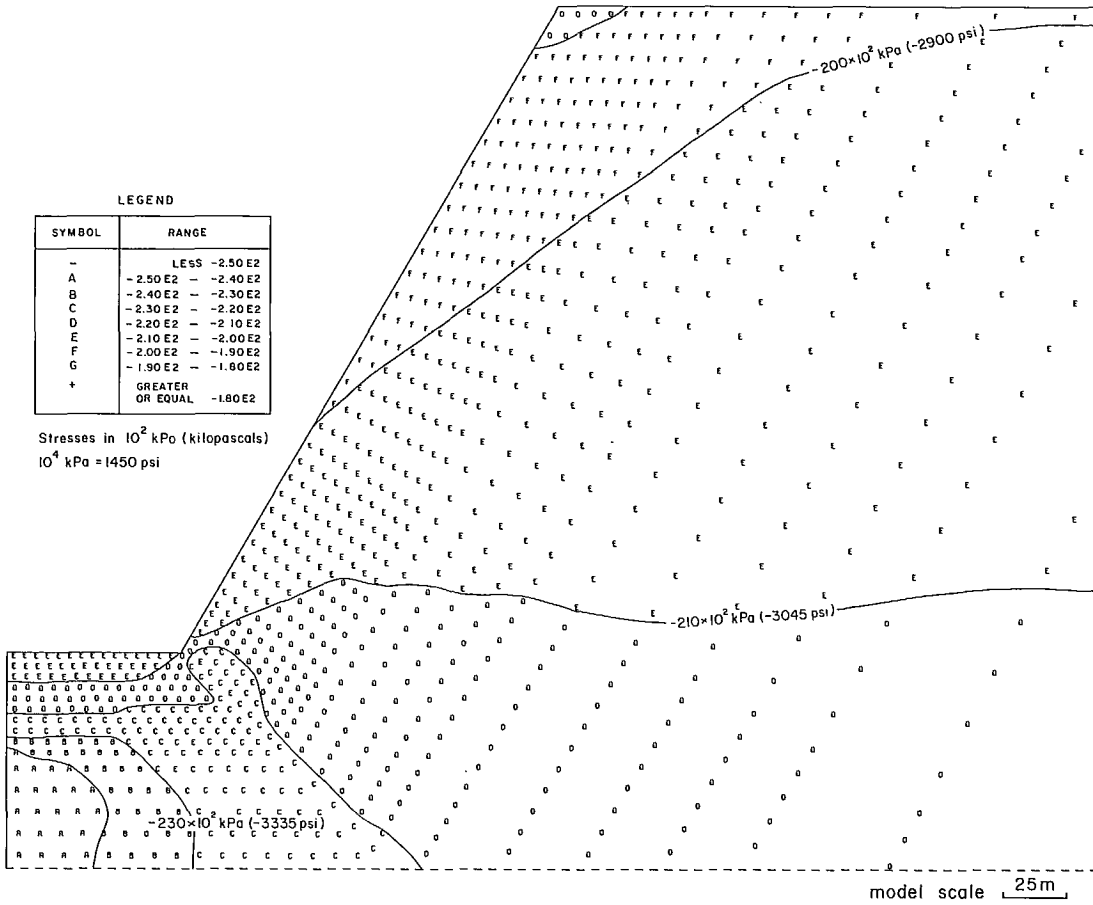

Fig B-34 - Drucker/Prager stress function point contours in critical region. (Cohesion =  $10^4$  RPa = 1450 psi, angle of internal friction =  $35^\circ$ ).

## REFERENCES

- B-1. Wilson, E.L. "SOLID SAP - A Static Analysis Program for Three Dimensional Solid Structures"; UC SESM 71-19 University of California, Berkeley U.S.A.; 1972.
- B-2. Toews, N.A. and Yu, Y.S. "A Computer program for Automatic Mesh Generation for the 2-d Finite Element Program WILAX"; Research Report R272 Mines Branch; Department Energy, Mines and Resources; Ottawa; 1973.
- B-3. Zienkiewicz, O.C. and Phillips, D.V. "An Automatic Mesh Generation Scheme for plane and curved surfaces by 'Isoparametric' Coordinates"; Internat. J. for Numerical Methods in Engineering; v. 3; pp 519-528; 1971.