



Energy, Mines and
Resources Canada

Énergie, Mines et
Ressources Canada

CANMET

Canada Centre
for Mineral
and Energy
Technology

Centre canadien
de la technologie
des minéraux
et de l'énergie

22(21)
212tc
77-9
(c.3)
Su
622(21)
C212tc
77-9
(c.3)

ELDORADO NUCLEAR LIMITED
R & D LIBRARY OTTAWA

FILTRATION - FILTERS AND FILTER MEDIA

H.A. Hamza

AUGUST 1977

CANMET LIBRARY
#11- C3
BIDLIPOURIE
555 SOUTH STREET
OTTAWA ONT. CANADA
K1A 0G1

~~CANMET LIBRARY
C2
JAN 26 1978
BIBLIOTHEQUE
555 SOUTH STREET
OTTAWA ONT. CANADA
K1A 0G1~~

ENERGY RESEARCH PROGRAM
ENERGY RESEARCH LABORATORIES
CANMET REPORT 77-9

© Minister of Supply and Services Canada 1977

Available by mail from:

Printing and Publishing
Supply and Services Canada,
Ottawa, Canada K1A 0S9

CANMET
Energy, Mines and Resources Canada,
555 Booth St.,
Ottawa, Canada K1A 0G1

or through your bookseller.

Catalogue No. M38-13/77-9
ISBN 0-660-01174-3

Price: Canada: \$2.00
Other countries: \$2.40

Price subject to change without notice.

© Ministre des Approvisionnements et Services Canada 1977

En vente par la poste:

Imprimerie et Édition
Approvisionnement et Services Canada,
Ottawa, Canada K1A 0S9

CANMET
Énergie, Mines et Ressources Canada,
555, rue Booth
Ottawa, Canada K1A 0G1

ou chez votre libraire.

N° de catalogue M38-13/77-9
ISBN 0-660-01174-3

Prix: Canada: \$2.00
Autres pays: \$2.40

Prix sujet à changement sans avis préalable.

FOREWORD

A study of solid-liquid separation was initiated by CANMET in 1976 with the aim of improving coal-cleaning processes and alleviating environmental damage by the mining and processing industries. Water conservation, reduction of land required for settling ponds, and prevention of stream contamination by plant effluents were among the intended immediate benefits.

This report is one of a series to be published on solid-liquid separation. Aim is to explore the fields of flocculation and agglomeration, thickening and clarification, and filtration. Filtration is one of the most widely used unit operations and its field of application is as diverse as the industries applying it. The subject is being covered in two reports, the present one being devoted to filters and filter media, and the second, to follow, will review filtration theory. It is believed that these publications should be of help to those faced with the selection of filters and filter media for particular applications.

A handwritten signature in black ink, appearing to read "B.I. Parsons", with a large, stylized flourish above the name and a horizontal line underneath.

B.I. Parsons
Chief, Energy Research Laboratories

AVANT-PROPOS

En 1976, CANMET a entrepris une étude sur la séparation des solides et des liquides en vue d'améliorer les procédés de dépoussiérage du charbon et d'atténuer les dégats causés à l'environnement par les industries d'extraction et de traitement. Parmi les avantages immédiats prévus, figurent la conservation de l'eau, la réduction de la superficie nécessaire aux bassins de décantation et la prévention de la contamination des cours d'eau par les effluents des usines.

Le présent rapport fait partie d'une série de documents sur la séparation des solides et des liquides, qui va être publiée sous peu. Il a pour but d'explorer les domaines de la floculation et de l'agglomération, de la concentration et de la clarification, ainsi que de la filtration. La filtration est l'une des opérations les plus couramment utilisées et son champ d'application est aussi étendu que les industries qui l'emploient. Ce sujet sera abordé dans deux rapports, dont le premier est consacré aux filtres et aux moyens de filtration, et le second, à paraître, étudiera la théorie de la filtration. Ces publications devraient certainement aider au choix des filtres et aux moyens de filtration pour des applications particulières.

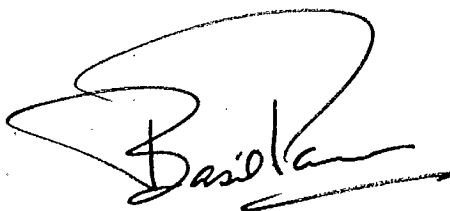
A handwritten signature in black ink, appearing to read 'Basil Parsons', with a large, sweeping flourish above the name.

B.I. Parsons

Chef, Laboratoires de Recherche sur L'Energie

FILTRATION - FILTERS AND FILTER MEDIA

by

H.A. Hamza*

- - -

ABSTRACT

This report presents a detailed review of the application and operational aspects of the filtration process and outlines criteria that should be applied for selecting filters and filter media for various system and slurry characteristics.

Chapter I classifies filters according to their mode of operation and the driving force employed to effect separation between solid and liquid. They are therefore grouped according to whether used in batch or continuous operation, whether the driving force is gravity, pressure, vacuum, or centrifugal, and according to feeding arrangement and the mechanism of cake removal.

Generally, the most suitable filter for a given operation is the one which will fulfill the requirements at minimum overall cost. Since cost is related to filtering area, high rates of filtration are normally provided by high pressures and continuous operation. Maximum pressures, on the other hand, are often limited by mechanical design considerations and batch operation thus may be necessary.

The illustrated report provides essential characteristics of the most common types of filters, stating advantages and disadvantages of each. Plate filter presses are the most common batch filters. In continuous filters, filtration, washing, dewatering and cake discharge take place simultaneously. Continuous vacuum filters have wide application, particularly in rotary drum and rotary disc configurations, and are described in detail. Continuous pressure filters are similar in many respects to their vacuum counterparts but are more complex and expensive to build and operate. Factors which determine filter selection include cake formation characteristics, production level, required process results and construction materials. Filter selection is also based on slurry characteristics.

Chapter II discusses the various types of material used as filter media. Criteria are presented for making a selection according to application on the basis of physical properties - strength, blinding, or cake discharge, chemical properties - resistance to chemicals, to heat, etc. - and constructional properties - types of yarn, fabric geometry, weave pattern, etc. Optimum filter medium choice is a compromise between the maximum service life, recovery, cake release, permeability of flow, production rate, gasketing, resistance to blinding, and clarity of filtrate. Ranking of the numerous types of filter cloth as to suitability for various applications is presented in tabular form.

*Research Scientist, Western Research Laboratory, Energy Research Laboratories, Canada Centre for Mineral and Energy Technology, Department of Energy, Mines and Resources, Edmonton, Alberta, Canada.

FILTRATION - FILTRES ET SUPPORTS FILTRANTS

par

H.A. Hamza*

- - -

RESUME

Ce rapport présente une étude détaillée de l'application et des aspects opérationnels de la filtration et expose les critères dont il faut tenir compte au moment de choisir des filtres et des supports de filtration pour différents systèmes et diverses caractéristiques de la suspension à filtrer.

Le chapitre I classe les filtres en fonction de leur mode de fonctionnement et de la force motrice qui sert à séparer les solides et les liquides. On les classe dans différentes catégories selon qu'ils sont utilisés en contenu ou par lots, que la filtration est actionnée par la gravité, par pression, à vide ou par centrifugation, et selon le système d'alimentation et le mécanisme d'extraction du gâteau.

Généralement, le filtre qui convient le mieux à une opération donnée est celui qui répond aux exigences à un prix de revient minimal. Etant donné que le prix de revient est fonction de la surface de filtration, les filtres continus utilisés sous de fortes pressions permettent habituellement d'obtenir des vitesses élevées de filtration. Par contre des facteurs d'ordre mécanique limitent des facteurs d'ordre mécanique limitent souvent l'utilisation de pressions maximales, et il faut alors filtrer par lots.

Ce rapport illustré donne les caractéristiques des genres de filtres les plus communs et décrit les avantages et désavantages de chacun. Dans les filtres contenus, la filtration, le lavage, la déshydratation et l'extraction du gâteau ont lieu simultanément. Les filtres continus à vide, surtout les dispositifs rotatifs à tambours et rotatifs à disques, présentent un grand champ d'application, et font l'objet d'une description détaillée dans le rapport. Les filtres continus à pression ressemblent beaucoup aux filtres à vide mais ils sont plus compliqués, et les coûts de construction et d'exploitation sont plus élevés. Parmi les facteurs qui entrent en ligne de compte dans le choix d'un filtre, notons les caractéristiques de la formation du gâteau, le niveau de production, les résultats attendus et les matériaux de construction. Le choix d'un filtre repose aussi sur les particularités de la boue.

Le chapitre II étudie les différents genres de matériaux utilisés comme supports filtrants. Les critères qui y sont présentés permettent de

*Chercheur scientifique, Laboratoire de recherche de l'Ouest, Laboratoires de recherche énergétique, Centre canadien de la technologie des minéraux et de l'énergie, ministère de l'Energie, des Mines et des Ressources, Edmonton, Alberta, Canada.

choisir un support filtrant en fonction de l'usage que l'on veut en faire, d'après des propriétés physiques comme la résistance, l'obstruction ou l'extraction du gâteau, des propriétés chimiques comme la résistance aux produits chimiques, à la chaleur, etc., des propriétés de construction comme le genre de fils, la géométrie du tissu filtrant, la structure de l'entrelacement des fils, etc. Le choix d'un support de filtration optimal consiste en un compromis entre la durée utile maximale, la récupération, l'extraction du gâteau, la perméabilité de l'écoulement, le taux de production, les garnitures d'étanchéité, la résistance à l'obstruction et la pureté du filtrant. Le classement des nombreux genres de toiles filtrantes d'après leur convenance aux différentes applications est présenté sous forme de tableau.

CONTENTS

	<u>Page</u>
FOREWORD.....	i
AVANT-PROPOS.....	ii
ABSTRACT.....	iii
RESUME.....	iv
CHAPTER I - FILTERS	
INTRODUCTION.....	1
BATCH FILTERS	
I. Pressure Filters.....	2
1. Plate Filter Presses.....	2
a) Plate and frame pressure filter.....	3
b) Recessed plate or chamber pressure filter.....	4
c) Automatic plate and frame pressure filter.....	5
CONTINUOUS FILTERS	
I. Gravity.....	7
II. Vacuum.....	7
1. Rotary Drum.....	7
a) External filtering surface.....	7
i) bottom feed.....	7
ii) top feed.....	13
iii) precoat.....	15
b) Internal filtering surface.....	16
2. Rotary Disc.....	18
3. Rotary Horizontal.....	20
a) Travelling belt.....	20
i) ordinary.....	20
ii) panelled tray.....	21
b) Table (Disc).....	21
III. Pressure.....	23
IV. Centrifugal.....	25
GENERAL PRINCIPLES.....	27
FILTER SELECTION.....	28
REFERENCES.....	33

TABLE

<u>No.</u>		<u>Page</u>
1.	Appropriate Filter Types for Slurry Categories A to E.....	32

FIGURES

1.	Batch Filters.....	35
2.	Plate and Frame Pressure Filter Assembly.....	36
3.	Shriver Plate and Frame Pressure Filter.....	37
4.	Plate and Frame Pressure Filter.....	38
5.	Recessed Plate or Chamber Pressure Filter.....	39
6.	Recessed Filter Plates.....	39
7.	Continuous Filters.....	40
8.	Internal Piping of a Rotary External Bottom Feed Vacuum Filter.....	41
9.	Valve Head and Valve Seat of a Rotary External Vacuum Filter.....	41
10.	Valve Head of a Rotary External Vacuum Filter.....	42
11a	Drum Filter Discharge Mechanisms.....	43
11b	Drum Filter Discharge Mechanisms (cont.).....	44
12.	Schematics of some Drum Filter Discharge Mechanisms.....	45
13.	Ordinary Top Feed Filtration Cycle for Vacuum Drum Filter.....	45
14.	Hopper Dewaterer.....	46
15.	Precoat Vacuum Drum Filter Discharges.....	47
16.	Internal Filtering Surface Drum Vacuum Filter.....	48
17.	Rotary Vacuum Disc Filter.....	48
18.	Rotary Vacuum Disc Filter.....	49
19.	Ordinary Rubber Belt Filter.....	50
20.	Flow Diagram of Ordinary Rubber Belt Filter with Washing.....	51
21.	Ordinary Rubber Belt Filter.....	52

<u>No.</u>		<u>Page</u>
22.	Ordinary Pan Filter with Scroll Discharge.....	53
23.	Scroll Discharge.....	53
24.	Tilting Pan Discharge Mechanism.....	54
25.	Continuous Pressure (Precoat) Filter.....	55
26.	Continuous Centrifugal Filter (Pusher Type) Rear View.....	55
27.	Assembly of a Continuous Centrifugal Filter (Pusher Type).....	56
28.	Continuous Centrifugal Filter (Pusher Type).....	57
CHAPTER II - FILTER MEDIA		
	INTRODUCTION.....	61
	TYPES OF FILTER MEDIA.....	62
I.	Rigid Filter Media.....	62
	1. Loose.....	62
	2. Fixed.....	63
II.	Flexible Filter Media.....	63
	1. Woven Fabric.....	63
	2. Non-woven.....	67
	SELECTION OF FILTER MEDIA.....	67
	LITERATURE REFEPENCES.....	70
	TABLES 2-7 (SELECTION FACTORS).....	71-75

CHAPTER 1 - FILTERS

INTRODUCTION

The evaluation of conventional solid-liquid separation equipment forms part of the work program of a CANMET study initiated in 1976 having the purpose of improving coal cleaning processes and alleviating environmental problems associated with the mining and processing industries.

Specific objectives of the study include water conservation in water-scarce areas, reduction of land needs by reducing or eliminating settling-pond requirements, and reduction of stream contamination by plant effluents. These objectives will be met by application of sound engineering principles in selecting a water treatment system for removal of fine and ultra-fine suspended solids for a given set of conditions.

The present report is the first of two devoted to filtration practice and theory, and covers filters and filter media — a second will cover the theory of filtration. Chapter I will serve to distinguish between the different classes of filtration equipment available and to introduce general principles, based on process conditions and requirements, for making the best choice of filter type.

In all types of filtration, the slurry flows towards a porous membrane as a result of a driving force such as gravity, pressure, vacuum or centrifugal force. In each case the filter medium, which consists of the cloth and the first layer of cake, retains the solid particles from the slurry, adding successive layers to the cake as the filtrate passes through it.

The various methods of creating the driving force, the different methods of cake deposition and removal, and the different means of removing the filtrate from the cake subsequent to its formation, result in a great variety of filter equipment.

In general, filters may be classified according to the nature of the operation (continuous or batch), the nature of the driving force initiating filtration, the feeding arrangement, and the mechanism of cake removal.

The choice of filter equipment depends largely on economics i.e., the most suitable filter for a given operation is the one which will fulfill the requirements at minimum overall cost. Since the cost of the

equipment is closely related to the filtering area, it is normally desirable to obtain a high overall rate of filtration by using relatively high pressures and continuous operation. On the other hand, the maximum pressures are often limited by considerations of mechanical design and a batch operation may be necessary, particularly if the filter cake has a high resistance.

BATCH FILTERS

A series of interruptions or terminations in the process of filtration is the major characteristic of this class of filter e.g., after filtering-before washing, after washing-before drying, and after drying-before discharge. Such a process is cyclic and not continuous.

As shown in Figure 1, this class of filter may incorporate gravity, vacuum, pressure, or centrifugal action as the driving force, but pressure is most widely used particularly within the coal industry and therefore only pressure filters will be discussed under this heading.

I. Batch Pressure Filters

Unlike gravity or vacuum filters, which employ a limited pressure differential, pressure filters have the advantage of much higher direct hydraulic pressure. This advantage is sometimes out-weighed by reduced filtration rates due to great void restriction. This may be caused by compressibility of the cake, by solids being forced into the filter medium or by a combination of both.

These filters fall into two categories: plate filter presses and casing pressure filters. Only the former will be discussed, because it is the most commonly used type in the coal industry, especially for the filtration of shale tailings.

1. Plate Filter Presses

These are perhaps the most widely used and discussed of all pressure filter types and, since they are so well-known, only a brief description is required here.

Filtration by plate filter presses is necessarily a closed operation, because pressure must be applied to the filter medium through the surrounding slurry. Actually, this filter could more appropriately be called a pressure filter rather than a filter press, because the pressure used is hydraulic and not mechanical*.

The slurry is forced into the filter chambers which are designed in such a manner as to prevent the filtrate from escaping by any passage other than through the filter medium upon which the suspended solids are retained. Flow through the filter is directed to all chambers simultaneously so that each chamber fills up at the same rate, retaining equal amounts of cake and delivering equal amounts of filtrate.

The plate filter press has two principal forms: a) the plate and frame pressure filter and b) the recessed plate or chamber pressure filter. However a relatively new type, c) the automatic plate and frame pressure filter will also be discussed.

a) Plate and frame pressure filter

The standard plate and frame pressure filter consists of a metal frame supported on both sides by two horizontal steel rails upon which rides an assembly consisting of a varying number of alternating solid plates and hollow frames (Figures 2, 3). Both faces of each plate are grooved or studded to provide drainage channels for the filtrate. The edges are machined to form a water-tight joint with the filter cloth as a gasket. Each plate is covered with a filter cloth, a separate one for each side or one piece extending to both sides. The filter is closed either by a hand screw or by a hydraulic ram to make a liquid-tight seal between two end plates, one of which is fixed and the other movable. In closing the filter, minimum pressure is applied to reduce wear on the cloths. When filter cake is discharged or when the cloths are changed, the plates and frames are pushed apart along the horizontal rails by hand or by a ratchet device. On the other hand, when they are pushed back together a chamber is formed between each pair of successive plates.

* In fact "filter press" has become the accepted term when referring to the category as a whole, "pressure filter" being used to describe the individual types within the category.

Slurry is introduced through a port in each frame and the filtrate passed through the cloth on each side so that two cakes are formed simultaneously in each chamber, coming together when the frame is full. The frames may be triangular or circular but are usually rectangular and range in size from 6 x 6 in. to 61 x 71 in., and from 0.5 to 8 in. thick (1,2,3,4). Slurry may be fed to the filter through the continuous channel formed by the holes in the corner of the machined part of the plates and frames when they are clamped together. In this case, corresponding holes are cut in the cloths which act as gaskets. Cutting the cloth may be avoided by feeding the slurry through an external pipe connected to a lug at the side of each frame from which a connection is made to each chamber. Rubber bushes are provided so that a leak-proof joint is formed (Figure 4).

After the filtrate passes through the cloth, it courses down the grooved surface of the plates and is discharged through a cock into an open launder or through a closed channel. Open discharge has the advantage that the filtrate from each frame can be inspected separately and can be isolated from the rest if not satisfactory.

Two methods of washing the cake can be employed: "simple" washing or "thorough" ("through") washing. When simple washing is used, the wash liquid is fed in through the same channel as the slurry. In thorough washing, the wash liquid is introduced through a separate channel behind the filter cloth on alternate plates, and flows through the whole thickness of the cake, first in the opposite direction, then in the same direction as the filtrate (1).

b) Recessed plate or chamber pressure filter

This filter is similar to the plate and frame but is simpler in construction (Figure 5). Here, the use of a frame is obviated by utilizing recessed plates so that individual hollow chambers are formed between each successive pair. The feed passage is usually a comparatively large hole in the centre of each plate (Figure 6). Cloths are laid over each side of the plate and are secured in place by clips or screwed unions.

This filter is cheaper in construction than the plate and frame type but clothing is more difficult; there is greater wear and tear

on the cloth, and it is not suitable for thorough washing. Consequently, this type of filter is normally used for solids which have little value where washing can be eliminated, or for slurries with relatively low solids content where frequent dismantling of the filter is not required.

c) Automatic plate and frame pressure filter

An automatic, semi-continuous version of the plate and frame filter has been developed in recent years (Eimco-Burwell) (5,6). Main principle of the design is that two separate sets of circular frames, 1 to 3.5 in. thick, are oriented at 180° to each other and are mounted vertically to rotate about a common side shaft. While one set is rotated between the plates for filling, the other is automatically moved out into the cleaning position. With a set in the filling position, the filter appears to consist of a succession of chambers, each formed by a filter frame and two movable plates. Air pressure spreads the two plates against the gasketed filter frame, and maintains a seal throughout the filter cycle.

Slurry enters the chambers through feed ports and two separate cakes build up evenly on the filter medium on either side of the filter frame, with a split or narrow opening between them when they are completed. Filtrate is then squeezed through the cakes to the filtrate outlets by an air-blow introduced through the feed ports. If washing is employed, the wash water follows the same flow pattern as the slurry, completely filling the opening between the two cakes, and passes through the cake and the filter medium. Drying air follows the wash water outward through the two cakes.

The cake is discharged by air-blow, which collapses the cakes into the splits in the centre of each frame and cleans the filter medium. The two plates are then retracted from the frame by means of vacuum, and the frame is rotated outward from between the plates for cleaning while the other frame is moved into position between the plates for the next cycle.

Although this filter has the disadvantage of being relatively complex and higher in initial cost, it has the following advantages over the conventional plate and frame filter:

- 1) elimination of hand labour
- 2) greatly simplified discharge resulting from the use of twin circular frames which, together with fully mechanized opening and closing, reduces shut-down time between cycles and gives rapid turn-around. This permits the use of short cycles and thin cakes, resulting in very high output per unit area. Down time between cycles is claimed to be two minutes or even less.
- 3) longer cloth life is obtained since normal damage caused by operators during discharge is avoided
- 4) better washing is possible.

Some of the advantages and disadvantages of plate pressure filters are listed below (1,2,7,8). Advantages are:

- 1) simple construction and can be made of a wide range of materials
- 2) low initial cost (the least expensive per unit area if cast iron or wood are used), low installation cost, and low power requirements
- 3) low maintenance cost since there are no moving parts
- 4) large filtering area is provided in a small floor space
- 5) in the plate and frame type, capacity and cake thickness can be varied by altering the number and size of frames
- 6) high filtering pressures of up to 250 psi (1), or as high as 1000 psi in special cases (3)
- 7) all joints are external, therefore leakages can easily be detected, facilitating maintenance
- 8) on the plate and frame type, filter cloths can readily be removed and replaced.

Disadvantages of plate pressure filters include:

- 1) intermittent operational characteristics
- 2) high rate of medium wear due to frequent dismantling, particularly in the recessed plate
- 3) high labour costs (except in the case of the automatic plate and frame) and therefore used where the market value of the cake is high or where the solids percentage is low

- 4) uneconomic cycles often result from the necessity of having to fill the chambers before the cake can be washed or discharged
- 5) frequent serious leaks.

CONTINUOUS FILTERS

Various designs for specific applications of this class of filter have been developed. In all of them, filtration, washing, dewatering, and discharge of the cake take place simultaneously without interrupting normal operation. They may incorporate the use of gravity, vacuum, pressure or centrifugal force as shown in Figure 7.

I. Continuous Gravity Filters

This category may include the rotary disc, rotary screens and reciprocal screens. The continuous rotary screen type (2,3) consists principally of a deeply submerged horizontal rotating drum of screen wire through which the filtrate flows by hydrostatic head, leaving a layer of solids on the screen. Its use has been restricted exclusively to the pulp and paper industry. The rotary disc and reciprocal screen will not be discussed since use of the former is very limited and the latter is in effect an ordinary reciprocating or shaking dewatering screen.

II. Continuous Vacuum Filters

There are three main groups of continuous vacuum filters: 1) rotary drum, 2) rotary disc and 3) rotary horizontal. The rotary drum and the rotary disc types, in that order, are the mostly widely used.

1) Rotary Vacuum Drum Filters

This type of filter may be classified into two major divisions: a) filters with external filtering surface which include bottom feed, top feed (ordinary, dual drum and hopper dewaterer) and precoat, and b) filters with internal filtering surface.

a) Filters with external filtering surface

i) Rotary external bottom-feed vacuum drum filters

This type is designed either as single-compartment or as multiple-compartment drums. In the former, the entire drum interior is placed under vacuum. A close-fitting "shoe" is fitted internally to provide blow-back for cake discharge, and further internal fittings are necessary if it is desired to keep wash liquid separate from the main filtrate (Figure 11a) (1,2,6).

The multiple-compartment form, which is more widely used, consists of a cast cylinder mounted on an axial horizontal shaft and is partially submerged in a tank into which enters the slurry to be filtered. The slurry is fed to the tank at a rate slightly greater than the filtration rate so that, with the aid of an overflow pipe, the slurry level in the tank is kept constant. Material of construction for the tank depends on the nature of the slurry to be filtered but is usually cast iron or steel and may sometimes be timber, stainless steel, copper, Monel, rubber-lined (9) etc. Some form of agitation (usually of the oscillating type) is provided in the tank to keep the solids in suspension.

The surface of the cylinder is subdivided into a number of independent longitudinal shallow compartments by means of radially arranged partitions. Each compartment is connected by a separate pipe which first runs radially, then turns along the shaft (Figure 8) and ends at one of the trunnions forming the moving part of the automatic valve, usually referred to as the "valve seat". A machined wear plate is bolted to the valve so that the holes in the wear plate coincide with those in the valve seat (Figure 9).

The stationary part of the valve, referred to as the "valve head" or "valve body" is equipped with annular recesses and adjustable or fixed bridges which create separate sections and control the cycle of the operation (Figure 9 and 10a). The annular sections are connected by flexible pipes, either to vacuum for filtering, washing and dewatering, or to positive pressure for blow-back (Figure 10b). The valve head is held firmly in place against the valve seat by a coiled spring which is retained between a regulated lock nut on the end of the valve stem and the

back of the port plate on the valve head. While stationary, the valve head is connected flexibly to the vacuum receivers and to the blower by rubber hoses. This is to simplify adjustment needed to satisfy operating conditions, to provide easy alignment, to avoid valve head strain, and to absorb vibrations (2). Both the valve seat and head are machine-faced and make a perfect fit, the joint surface being lubricated by a grease cup. Tightness between the valve seat and head depends largely upon the pressure induced by the vacuum within the filter. The bridges in the head are often adjustable from the outside, allowing them to be moved without disconnecting the valve head.

To support the filter medium, the outer cylindrical surface of the drum is built in the form of a drainage deck or grid which may be composed of heavy woven wire, perforated plate, metal gauze or wooden slats. Numerous points of support are therefore created for the filter medium which is either in one piece covering the entire cylindrical surface of the drum, or divided longitudinally into sections or panels. In the former case, the medium is held on the drum by single wound-wire or woven-wire screen, whereas in the latter case, the medium sections are caulked with rope into grooves cut in the upper surface of the compartments' dividing strips. The wire winding and the metal screen afford considerable protection for the medium but on the other hand, the caulked medium can be more rapidly installed and maintenance is simplified. The wire-wound drum filter is particularly applicable for solids which form thick and easily-discharged filter cakes (cakes 1/4-in. and thicker can be handled without difficulty), whereas the panel-type drum filter is suitable for handling thin cakes. In the latter type, the medium is also free to pull away from the drum surface during cake discharge thus allowing the scraper to remove thin or slimy cakes (10). The drum is normally constructed of cast iron for sizes up to 150 sq ft, of cast iron or steel for 150 to 400 sq ft, and of steel only for sizes above 400 sq ft. For special applications it may be constructed of other suitable materials such as Monel metal, stainless steel, coated metal, etc. (9).

As the drum rotates during operation, each compartment in turn is dipped into the slurry in the tank. The liquid is sucked through the filter medium into the compartments and proceeds to the drum piping and

out through the first arc of the filter valve. The solids are deposited on the surface of the cloth forming the filter cake on the outside of the rotating drum. Washing can take place soon after the cake emerges from the slurry. As the cycle progresses, air is then drawn through by vacuum to dewater the cake. The residual liquid, together with the wash liquid if washing is performed, passes through the second arc of the valve. As each filter compartment rotates to the point of discharge, vacuum is automatically cut off and replaced by positive pressure through the next arc of the valve to loosen the cake. The final arc, which occurs between cake discharge and resubmergence of the compartment, is either a dead section or an extension of the region of positive pressure. In either case, this is meant to avoid vacuum loss and additionally, in the latter instance, to clean the cloth before starting a new cycle. Section or arc separation and vacuum cut-off before discharge are achieved by positioning the fixed and adjustable bridges relative to each other.

Filtration takes place at approximately constant vacuum except in the initial stages when air is being evacuated from the compartment. This initial phase occupies about 3% of filtration time for slow filtering materials, and up to 20% for free filtering materials (1).

There are several methods of removing filter cakes from the drum (Figures 11a, 11b, 12):

Scraper discharge - The conventional means of cake discharge, and the one most commonly used, employs an adjustable scraper. The mechanism usually consists of an adjustable and removable narrow scraper made of steel having a bevelled edge and hinged along the lower edge. The scraper is often balanced to minimize wear and tear of the cloth. This type of discharge is usually combined with blow-back which loosens the cake and in this case the scraper is considered to act as a deflector.

Belt discharge (1,2,7,12,13,14) - There are two types of belt discharge. In the first type, the belt is placed around the filter drum on top of the medium, and in the second, the filter medium behaves somewhat like an endless belt (in this case the filter is sometimes called a "Rotobelt" filter). This type of discharge is designed to avoid clogging of the medium by removing it from the drum during each revolution. The

belt leaves the drum near its top arc after drying of the cake. The belt may be made of cloth, wire mesh, or flexible fabric, arranged to follow the contour of the drum and the discharge and return rollers. Various methods for maintaining alignment and vacuum seal have been developed.

As shown in Figures 11 and 12, the belt lies on the drum surface, with the cake over it until it is transferred off the drum to the discharge roller where the formed cake breaks away as a result of the sudden change in curvature coupled with a flexing action of the belt. The belt then goes under a wash roller where it may be sprayed or passed through a solvent before travelling over a return roller back onto the drum surface. The spraying liquid or solvent used for washing both the front and back of the belt is contained in a wash trough which is separate from the filter feed tank. This prevents dilution of the feed and interference with actual filter operation.

Belt discharge has the same advantages as string discharge and can, moreover, continuously and cleanly remove extremely thin cakes and constantly return a clean belt to the drum surface.

String discharge - This is sometimes used for cakes which tend to adhere unduly to the filter cloth. The cake is lifted off the drum by a series of individual endless strings, usually spaced at 1/2 in. or 3/8 in. (2) over the entire width of the drum. The strings pass approx 270° around the filter drum (11) and over a small diameter discharge roll which is adjustable to maintain string tension. The abrupt change of curvature is sufficient to dislodge the cake for discharge. An aligning comb guides the strings to the return roll before they go back to the drum prior to resubmergence, and also serves to scrape off lumps of adhering cake. In some designs the strings may be replaced by chains or wire mesh.

The cake is formed over the strings on top of the filter medium and as the strings leave the drum during discharge, they actually support and lift off the cake in a continuous sheet to the discharge roll. In this manner, cakes of 1/8-in. thickness and up (but in some cases 1/16-in. thickness) can easily be handled.

A major advantage of this discharge is that it eliminates the need for blow-back with the result that the automatic valve of the filter

is simpler than the conventional type. The corresponding annular recess in the valve is blocked off to effect vacuum cut-off just before the strings leave the drum and until that section is resubmerged. In addition, by discharging the cake over a roller away from the drum, no filtrate blow-back is encountered.

Wire discharge - This is used where thin sticky cakes are involved or where there is a danger of soft solids smearing the filter cloth. The scraper is replaced by a taut wire located at about the same position as the conventional scraper tip.

Roll discharge - This is often used for removal of thin light cakes. Discharge rollers which generally turn with the drum bear lightly on the solids which adhere to the roller upon contact and are then cut away from the roller, usually with a knife edge.

Blow-back discharge - Where blow-back is used, the vacuum is commonly cut off and positive pressure is applied starting just before the leading edge of the compartment reaches the scraper, and continuing until the lagging edge reaches the same point. Blow-back is either continuous or pulsating. Combined blow-back and scraper discharge has the following disadvantages:

- (i) flexing of the filter cloth during blow-back weakens the cloth and shortens its life especially if it is turning against a scraper knife
- (ii) during discharge, filtrate is blown back into the cake from piping resulting in wetter cakes (6).

Advantages, disadvantages and applications of the rotary bottom-feed vacuum drum filter are summarized below (1,2,7). Advantages include:

- 1) continuous and automatic operation, hence low operating labour
- 2) design and operational variations (method of discharge, drum speed, vacuum, cloth, submergence, cycle, etc.) cater to a wide range of suspensions of divergent nature
- 3) clean operation
- 4) low maintenance cost
- 5) effective washing and dewatering

- 6) wash filtrate separation.

Main disadvantages are:

- 1) high capital cost
- 2) limitations imposed by vapour pressure of hot or volatile liquids
- 3) incapable of handling products that form explosive or inflammable gases under vacuum
- 4) unsuitable for quick-settling slurries
- 5) tendency to cloth blinding due to thin cakes and short cycles which, however, can be overcome by utilizing belt or string discharge
- 6) wetter cakes if blow-back is used, and greater medium wear if blow-back is used in conjunction with a scraper knife.

Applications are widespread and include clays, fine coal concentrates, flocculated raw coal slurries, metallurgical effluents, pulp and paper, chemicals, petroleum, plastics, sewage, etc.

ii) Rotary external top-feed vacuum drum filters

An interesting and important modification of the rotary vacuum drum filter is the top-feed filter for use with quick-settling slurries. These slurries would normally be difficult to filter with conventional drums unlike top-feed filters where the settling effect of gravity works in the same direction as the applied vacuum.

Top-feed filters may be classified as ordinary, dual-drum and hopper dewaterer types.

Ordinary top-feed filters

This filter consists of an orthodox multiple-compartment rotary vacuum drum and, as with the conventional bottom-feed filter, cake formation occurs with, rather than against, gravity. No filter tank is required, and cake formation usually occurs in the region shown in Figure 13 between point 1 and point 2 and will be completed before point 3. The formed cake is carried by the drum, to be discharged in the region of point 5. In some units it may be advisable to have one or two additional scraper blades located at point 4 or further on to remove top layers of solids (15).

The filter must be fitted with a feed box equipped with special baffles or a paddle agitator to distribute the feed slurry evenly across the drum face. In addition, a dam is required near the point where vacuum is first applied to prevent feed run-back and to maintain a pool of slurry for cake formation.

As previously stated, top-feed filters are used for coarse solids which cannot normally be kept in suspension in the filter tank of a conventional drum filter. As a general rule, the amount of minus 200-mesh solids is limited to a maximum of approximately 30% and the slurry should be relatively free of particles finer than five microns. Accordingly, cake formation will occur in a short period of time, usually less than 10 seconds. Poor uniformity and increased moisture content of the cake due to classification of the feed solids will result if longer times are used. Air rates through the cake will usually be high, ranging from about 25 to 200 cfm/sq ft of the total area (15).

The difficulty of feed run-back with this type of filter has been overcome in three different ways: by the use of retaining dams as discussed earlier, by using dual drums, and by means of drum surface hoppers, to be described in the section on hopper dewaterers.

Dual-drum top-feed filter

This type of filter consists of two orthodox multiple-compartment rotary vacuum drums, synchronized, rotating in opposite directions, and fitted with retaining dams to provide an overdrum feed pool above the centre line of the filtering surface. Dual-drum filters are suitable for quick-settling materials, but have the disadvantage of being expensive and consequently are used only in special circumstances (2,16).

Hopper dewaterer

The hopper dewaterer is principally a multiple-compartment rotary drum with ends that have been extended radially from 4 to 12 in. beyond the filter medium (Figure 14). Retaining plates are placed vertically across the drum face along the division strips to convert each compartment into a hopper. In one design, each leading hopper retaining-plate is withdrawn automatically as that hopper approaches inversion and in this case, a scraper discharge can be used, with or without blow-back.

The hoppers may also be entirely separate units with individual filter media fastened together through outer and inner rings. For cake washing, a spray or drip-washing attachment may be set above the hoppers and washing applied as soon as the surface liquid disappears.

The slurry is fed to the hoppers from an overhead chute at approximately 20° before the individual hopper reaches its zenith, and vacuum is applied at this point. Vacuum is normally kept on to approximately 30° of inversion of each hopper, where it is automatically cut off and blow-back applied for discharge. The blow-back, assisted by both the effect of gravity and the shape of the compartment, usually ensures clean discharge together with reduced cake cracking during the washing and drying periods (2,3,5).

Concentrated slurries of high specific gravity can be handled by this filter because of the fact that the slurry will be confined within the hoppers. The depth of the hopper and speed of rotation of the drum can be varied for thick or thin slurries. This filter, like the ordinary top-feed form, is built in sizes ranging from 18 in. to 6 ft in diameter and with drum faces of 1 to 6 ft (5).

iii) Rotary precoat vacuum drum filter

This is a standard multiple-compartment rotary vacuum drum filter except that prior to filtration, a 2- to 3-in. thickness of precoat (e.g., diatomaceous earth or fly ash (6)) is formed on the filtering surface and filtration takes place through the precoat which acts as the filter medium. A predetermined thin layer of the precoat, usually between 0.0006 and 0.0059 in. per min (17), is continuously shaved off with the filter cake during discharge by an advancing knife mechanism (Figure 15a, 15b). A fresh surface is thus exposed for filtration at each revolution of the drum. Depth of the cut into the precoat can be adjusted manually or automatically. When precoat thickness is reduced to about 1/4 in., the operation is halted and a new layer is applied by normal filtration. After applying the precoat layer, the filter tank must be emptied of the precoat material and filled with slurry before recommencing the operation. No air-blow is necessary for cake discharge, and agitation, when used, is normally of the paddle type.

This filter can be operated either as an open or vapour-tight vacuum or pressure filter and is best suited for:

- 1) solution clarification where there is too little solids to form sufficient cake to be discharged on the conventional type of filter
- 2) cakes which have very high resistance and blind the cloth if used without precoat (e.g., semi-colloidal solids)
- 3) operations where exceptional filtrate clarity is required.

Strictly speaking, this filter is not continuous since the precoat must be renewed periodically and the operation is therefore continuous only for the life of the precoat. This may vary from 8 hours to as much as two weeks depending upon the character of the slurry (2,3,10). The filter can produce highly clarified filtrates and can handle sticky slimy solids which are otherwise unsuited to vacuum filtration. On the other hand, it has the disadvantage of being limited to low viscosity slurries, and the cake is always contaminated with precoat material. Initial installation costs are generally higher than for the conventional type, and operation is more expensive because of the precoating materials. Washing cannot readily be accomplished with this filter.

Filters with internal filtering surface

In effect, these filters are of the rotary vacuum multiple-compartment drum type but have their filtering surface on the internal instead of the external drum periphery (Figure 16). The outside surface of the drum is solid except for the suction piping connections which are fitted externally. Consequently, considerable difficulty would be encountered if a continuous wire-wound medium were to be used, and panel construction is therefore necessary. One end of the drum is closed and carries the filter valve, while the other end is open for feed entrance and cake removal. There is no tank for the feed slurry which is discharged from a distributor into the bottom of the drum interior. The slurry is held in a pool by the closed head and by a baffle ring which partially closes the open end. Any settling of solids in the slurry assists filtration and, therefore no agitation is required. The drum is supported by a trunnion bearing at the closed end and by a large ring around the drum at the open

end. The drum is driven by a variable speed motor, the drive is transmitted by a worm gear at the trunnion end and the ring rides on rolls (2,16).

As the drum rotates, the compartments successively pass through the slurry pool where vacuum is applied as each compartment becomes submerged. As the filter compartments (still under vacuum) emerge from the slurry, the drying part of the cycle begins, and further dewatering of the cake is effected. To prevent the deposit of slimy fines on the filter surface as it enters the pool, a slight air blow-back may be used until the filtering section is well submerged (3). The cake is discharged at the top of the drum where vacuum is cut off, and gravity, usually aided by pulsated blow-back, causes the cake to drop off on a screw or belt conveyor in the larger models, or simply to a chute in the smaller ones. In either case, cake leaves the filter through the open end.

Washing, if required, may be effected by sprays located within the drum and directed towards the cake as it emerges from the slurry. There is the disadvantage of limited washing time however, since only half the drum is available during the entire filtration cycle. The wash liquid also tends to drain back into the slurry causing dilution.

This type of filter is particularly suited to quick-settling materials like those handled by either top-feed or horizontal filters and, in this respect, it is better than the conventional drum type.

Some advantages and disadvantages of the internal vacuum drum filters are given below (2,7,16). Advantages are:

- 1) handle quick-settling slurries
- 2) initial cost is lower than for conventional drum filters since there is no slurry tank or agitator
- 3) variations in feed consistency cause little difficulty
- 4) the filter may be conveniently insulated if elevated temperatures are required.

Disadvantages are:

- 1) only a limited area of the drum is used
- 2) washing time is limited because of the short cycle
- 3) coherent cakes are necessary, since the cake would otherwise fall off before the discharge point resulting in loss of vacuum
- 4) chute-discharge is limited to friable cakes
- 5) re-clothing is slower and more difficult than for the external drum filters
- 6) when applied, washing must be directed against the force of gravity.

2) Rotary Disc Vacuum Filter

The rotary disc filter unit consists of one or more equispaced discs mounted on a common heavy-duty horizontal centre shaft (Figure 17a, 17b, 18). Each disc is circular in shape and is divided into a number of uniform separate tangential sectors connected by pipes through the centre shaft to an automatic valve similar to that in the drum filter. Where several discs are mounted on the same shaft, each pipe serves as a filtrate and wash channel for all corresponding sectors along the shaft. The sectors are interchangeable and can be readily removed to facilitate change of medium. The complete sector may be taken out and a replacement inserted while the unit is operating. Each sector has a projecting drainage nipple which fits into a shouldered sealed opening in the centre shaft and is retained by means of two shared radial rods. Each rod is screwed to the centre shaft at one end, and has a clamp and nut on the outer end to hold the adjacent sectors in place.

The filter medium, if it consists of fabric, is in the form of a bag, cut and sewn to fit the sector, and supported on backing which covers both faces of the sector. Metallic filter media are welded or soldered to the backing screens. The centre shaft is mounted on the slurry tank in which the discs are suspended. The tank has a crenellated construction on the cake discharge side, with one crenellation for each disc.

Agitation is difficult in the slurry tank and, in moderate settling materials, the discs act as agitators as they revolve. However,

special agitators have been developed to keep quick-settling solids in suspension. In this case the filter is called the Agidisc filter. The agitator moves slowly so as not to disturb cake formation, but is fast enough to keep coarse solids in suspension. The slurry is fed to the tank from above, and the level is kept high enough to completely submerge each sector entering it. Washing is sometimes carried out with sprays located on either side of each disc.

As the cake forms on both faces of the disc, it is discharged by means of straight or contoured spring-adjusted scrapers or discharge rolls mounted on the sides of the disc. Discharge is usually assisted by a sudden snap or pulsating air-blow, or by vacuum release (5).

The discs range in size from 4 to 12.5 ft in diameter, 1 to 12 discs per unit and 8 to 15 sectors per disc, providing from 22 to 2400 sq ft of filter area per machine (2); or from 18 in. to 13 ft in diameter, 1 to 14 discs per machine, providing an area of 3 to 2800 sq ft (5,18).

In operation, the rotary disc vacuum filter is very similar to the rotary drum vacuum filter. Some of the advantages, disadvantages and applications of the rotary disc vacuum filter are listed below (1,2,3,5,7).

Advantages include:

- 1) low capital cost per unit area (less expensive than drum filters)
- 2) large filter area with minimum floor-space requirements
- 3) rapid medium replacement
- 4) different slurries may be handled simultaneously in one unit by partitioning the filter tank and using one or separate automatic valves
- 5) generally used for handling large volumes of relatively free-filtering solids normally 40-200 mesh (2).

Disadvantages include:

- 1) good washing is difficult because of vertical cake surfaces and limited drying time
- 2) cakes are wetter than those obtained with the drum type
- 3) excessive filtrate blow-back on some designs
- 4) discharge of thin cake is more difficult

- 5) inflexible in operation since variation in depth of submergence is limited
- 6) rate of medium wear is inclined to be high with scraper discharge
- 7) unsuitable for non-coherent cakes
- 8) no means of separating different filtrates if the unit is used to filter more than one slurry simultaneously.

Disc filters have been successfully used for cement, starch, sugar, flotation coal concentrates and flocculated raw coal slurries, as well as paper, minerals, metallurgical flue dusts, etc.

3) Rotary Horizontal Vacuum Filters

These may be divided into two main groups: a) the travelling belt filter (which may include the ordinary rubber belt and the panelled tray belt types) and b) the rotary table or horizontal disc filter.

a) Travelling belt filters

Ordinary rubber belt filter

This filter consists of two rubber belts mounted on a framework (2,3,19) (Figures 19,20,21). The main belt has upturned edges and a number of holes along its centre line connected to grooves in the upper side. Mounted above the main belt in the filtering position is a perforated rubber belt which carries the filter cloth. The two belts and the filter cloth move close together on the upper horizontal part of the filter, the main belt sliding over a suction box. Both the belts and the filter cloth hang free on the underside.

If the suction box is put under vacuum, the filtrate will pass through the filter cloth and then through the channels between the two rubber belts to the suction box. The box can be partitioned into a number of sections, each receiving a fraction of the filtrate. After the cake is formed, rubber partitions mounted on top of the filter wipe against the cake and divide the different wash liquids (3). The feed is pumped onto the filter at one end, wash liquid is added along the way, and the filter cake is conveyed by the belts to the end pulley where it is removed by gravity, sometimes assisted by a knife edge. The different belts can be washed as they pass to the underside of the filter on the return trip.

Pannelled tray belt filter

The tray belt filter is composed of a number of trays or boxes forming an endless belt (2,3,19). Each tray has an inner perforated bottom over which the filter cloth is stretched and fastened by side-groove caulking. The trays are fitted with wheels rolling on the framework of the filter and the belt is moved forward by means of racks fastened to both sides of the trays (16,19). Each tray is connected by rubber hoses to a rubber suction belt sliding over a suction box similar in construction to that of the rubber belt filters. Trays may be washed on their return trip.

This filter has a number of advantages over the rubber belt filter:

- 1) it is comparatively cheap in construction because less rubber is required
 - 2) it can be built in larger sizes than the belt filter which is limited because of the very high stresses that are progressively incurred as size increases
 - 3) thicker cakes and consequently better washing results are obtained because the trays can be made to any depth (upturned edges of the belt filter are limited to approximately 4 in.)
 - 4) the kinds of filter media used with the rubber belt filter are restricted because the filter cloth forms a separate belt
 - 5) trays can be made of or lined with special materials to allow for variations in slurry characteristics.
- b) Rotary table or horizontal disc filter

This vacuum filter (20,21), originally known in metallurgical works as the sand-table, is the most widely used of all horizontal types. It may be subdivided into ordinary pan or tilting pan types depending on the discharge mechanism. In both cases it consists of a single disc or pan composed of a number of wedge-shaped segments each connected to and rotated on a central vertical shaft which is driven by a variable-speed motor. Each segment is in the form of a thin box which slopes towards and connects directly to a central multiple valve similar to that in the rotary vacuum drum filter. An individual horizontal filter cloth rests on a

pervious base which forms the top of each section, and the cloth is caulked into grooves around the edges of the section.

In the ordinary pan filters (Figures 22,23) the cake is discharged by means of an independently-driven scroll or alternatively, by means of paddles. Both are located in front of a radial dam in such a position as to prevent feed run-back to discharge. The dam is located close to the feed to minimize the dead area between discharge and feeding (2,19). The scroll has about 1/8-in. clearance leaving a layer of cake for re-cycle but, with some compressible materials, this could result in pore plugging and low capacities. There are no adequate means for medium cleaning such as blow-back, spray washing, etc., although in some cases the remaining cake layer is roughed up by a high velocity spray before new slurry is added. To overcome this drawback, improvements have been made in some of the latest designs (2,5,14) using a tilting mechanism (tilting pan filters) to overturn the whole disc or individual sector. In these designs (Figure 24), vacuum is maintained until a certain inclination is reached to prevent the cake from sliding and is then cut off for discharge which is effected by gravity, assisted perhaps by blow-back. After discharge, the sectors may be washed to prepare for a new cycle.

In operation, the slurry is fed evenly by gravity onto the horizontal filter surface of the sections as they pass beneath a feed box. Vacuum for dewatering, washing and drying is automatically applied through the multiple valve immediately after feeding, all operations being assisted by gravity. Washing of the filter cake can be performed with properly spaced sprays or weirs.

Some of the more important advantages and disadvantages of horizontal vacuum filters are listed below (2,3,5,7,10,19). Advantages are:

- 1) excellent washing and sharp wash-liquid and filtrate separations: in this respect it is better than the drum filter
- 2) flexible operation
- 3) filtration is assisted by settling of the solids and it is thus suitable for handling quick-settling slurries
- 4) large tonnages per unit for rapid-dewatering slurries: 1/2-to 8-in. cakes can be formed and washed

- 5) no tank or agitator is needed .

Disadvantages include:

- 1) large floor space requirements
- 2) in the case of the belt filter, only about 45% of the area is effective
- 3) higher initial cost per unit area than a drum unit but this disadvantage is offset by higher capacity on a sq ft basis, since it can handle thicker cakes at higher speeds
- 4) in general, it is limited to free-filtering materials which build up about a 3/4-in. porous cake in the case of the straight disc type, as the scroll has a 1/8-in. clearance
- 5) for the straight disc, there is no adequate means of cleaning the medium and consequently filtrate clarity tends to be poor because an open medium is necessary
- 6) discharge mechanism is more expensive than for dewaterers, and is sometimes more expensive than for internal drum filters.

III. Continuous Pressure Filters

Basically, this type of filter is similar to its counterpart, the rotary vacuum filter, but uses pressurized gas or air (applied from the outside of the cake) as the motivating force (Figure 25). In addition, the filter cake and filtrate are generally discharged at, or slightly above, zero gauge pressure. Fabrication is accordingly more complex and expensive particularly because of the need to discharge the filter cake from the high pressure shell to the atmosphere.

These filters are fabricated in two general types: the rotary drum pressure filter (with internal or external filtering surface, the latter including ordinary and precoat types) and the rotary disc pressure filter and both have advantages and disadvantages similar to those of their vacuum counterparts.

The basic difference between this type and the continuous vacuum drum and disc filters is that the former is enclosed within a pressure-tight container which functions as the slurry tank. The space between the feed slurry and the enclosure is filled with a gas (normally air, CO₂ or N₂) under pressure which provides the filtration force.

Filtration, washing, and drying of the cake are attained in the same fashion as in the equivalent vacuum filters, except that the motivating force is achieved using pressurized gas and the spray for cake washing is admitted at a higher pressure than that within the casing (2). Removal of the discharged cake is one of the more difficult construction requirements of this type of filter, as pressure must not be lost during this phase. It may be accomplished either by a repulp slurry or dried cake discharge. When dried cake discharge is required, elaborate devices must be used (2,5).

It is essential that the slurry level be maintained fairly constant, this being achieved by a level-controlling device. Fluctuations in liquid level in a fixed-volume system will result in compression or expansion of the gas within the filter shell. This is to be avoided, especially in the case of a precoat filter because such variations in pressure can cause cake cracking and disturb the precoat layer, perhaps resulting in loss of part of the precoat.

Pressure filters of the continuous type have the following advantages and disadvantages in addition to those mentioned previously for their vacuum counterparts (2,3,5,7,22). Advantages include:

- 1) higher operating pressure available if required
- 2) higher capacity per unit area, especially for relatively non-compressible cakes
- 3) high pressure permits the use of liquified gases as solvents
- 4) low cake moistures obtainable with higher pressures and high temperature gases
- 5) applicable to fields beyond the capability of the vacuum rotary filters, where limitation may be caused by adverse temperature or pressure conditions inherent in the slurries.

Main disadvantages are:

- 1) very high initial cost because of the requirements of a pressure-tight enclosure and pressure-withstanding parts
- 2) high maintenance and replacement costs on pressure glands, etc., because of the relative inaccessibility of parts in the unit
- 3) elaborate synchronized controls needed, especially for cake dis-

charge.

Fields of application can generally be reduced to five categories:

- 1) when the vapour pressure of the liquid or the filter feed temperature is too high to permit efficient exploitation of vacuum
- 2) when the liquid viscosity is high or the solid particle size is small, necessitating a driving force greater than one atmosphere to obtain economic filtration rates
- 3) when high temperature gas is employed for the production of a dried cake
- 4) for filtration of hot saturated solutions which would exhibit excessive crystallization with a reduction in temperature
- 5) for elimination of higher labour costs of certain batch filtration methods.

IV. Continuous Centrifuge Filters

In these filters, the solids are separated from the liquid by centrifugal force, far in excess of the force of gravity or vacuum (1,2, 23). Two major types are discussed below.

The first type consists to two concentric drums lying on their sides and rotating in the same direction about a common horizontal axis. The surface of the outer drum or basket may be either perforated or solid. The perforated type is contained within a casing which has a number of outlets for discharge of the filtrate, whereas in the solid type, the filtrate overflows. Perforated baskets may be covered with a suitable filter medium if required. The inner drum, called the scraper, conveying member or scroll, rotates at a slightly slower speed than the outer drum and carries ploughs, a continuous helix, or other means for continuously forcing the solids across the face of the outer diameter. The difference in speed is not sufficient to interfere with separation, but it causes removal of all the solids except for a layer equal in thickness to the clearance between the two drums. The inner and outer drums are generally driven by a single motor but separate drives may be provided as in the case

of the Dynocone (1).

The slurry is fed to the centrifuge through a hollow shaft entering between the two drums, and is spun against the inner wall of the outer drum. The cake is retained while the filtrate overflows or passes through to the casing and out via the filtrate outlets. The cake is gradually moved along the surface of the outer drum where it is washed by liquid which enters the horizontal shaft. After drying, cake discharge takes place at the extreme end by the action of centrifugal force. The cake is forced out through an annular discharge channel and into a chamber provided in the casing. These events take place in quick succession, the time interval between slurry entry and cake discharge being of the order of 1/2 minute.

In the second type, called the "push" type or pusher continuous centrifuge (Figures 26,27,28), no scrapers, rakes or ploughs are used. The slurry is introduced continuously into the filter by a pipe ending at a conical distributor which accelerates the feed up to the speed of the basket, thus avoiding sudden impact (23).

The cake is formed in the space between the flange of the conical distributor and the end of the basket (Figure 28), and is intermittently moved along the surface of the basket by a reciprocating pusher. The pusher comes forward and forces the cake through a length of one stroke and returns immediately, leaving room for a further layer of cake to build up before it advances again. The filtrate is discharged through the holes in the basket if it is perforated, or through an overflow. The solids may be washed by a spray located within the basket before the cake is finally discharged. Filtrate and wash liquid can be separated. When the cakes reach the lip of the basket, they are projected tangentially into a collector casing where they are removed through an outlet in the base.

Cake thickness is governed by the distance between the surface of the basket and the flange of the conical distributor. The frequency and length of the stroke can be adjusted depending upon capacity, feed rate and characteristics of the feed. Since the solids remain in the basket for only a short time (sometimes as little as 30 seconds) rapid drainage is necessary, and therefore a large filter area per unit output

and a very open type of medium must be used.

Multi-stage units are available in which there may be as many as four filtering surfaces on the one shaft.

GENERAL PRINCIPLES FOR THE SELECTION OF FILTER TYPE

Selection of a specific filter type is a complicated process involving a large number of factors which must be considered in making the best choice (7,24,25,26,27).

According to Chalmers et al (26), the main factors which determine selection of the most economical filter are 1) cake formation characteristics, 2) production level, 3) required process conditions, 4) required process results and 5) materials of construction. In a given system, any one of these may be the overall deciding factor.

1) Cake Formation Characteristics

This factor indicates whether continuous filters, precoat (semi-continuous), or batch filters can be used. In general, if a 1/8-in. cake cannot be formed at about 20-in. Hg vacuum in 5 minutes or less, then continuous filtration is not practicable. Continuous filtration is often indicated for slurries which range from this lower limit up to cases of extremely free-filtering materials for which cakes 2 in. or thicker can be formed in a matter of seconds. Below this range of cake formation rates, precoat or batch methods should be used.

2) Production Level

Continuous operation is generally economical and desirable at relatively high production rates because of labour savings but is difficult to justify at lower production levels.

3) Required Process Conditions

Conditions such as operating temperature, presence of volatile or toxic liquids, whether the process is continuous or batch, etc., are very important in filter type selection. For example, vacuum filtration

may not be possible because of temperature or vapour pressure limitations. Temperature and chemical resistance may limit the choice of filter media which may in turn affect equipment selection. The presence of volatile, explosive, or toxic materials in a system necessitates the use of a totally enclosed filter.

4) Required Process Results

These are of particular importance in deciding the specific unit of a general type which may be the best choice. Washing requirements, degree of filtrate wash separation, and permissible method of cake discharge have considerable influence on the choice.

5) Materials of Construction

These may be limiting factors because of their influence on filter cost and design and fabrication difficulties.

FILTER SELECTION BASED ON SLURRY CATEGORY

Chalmers et al. (26) gave a comprehensive discussion of filter selection and provided a chart in which slurries were arbitrarily subdivided into five categories. Appropriate filter types were indicated (Table 1) with qualifying remarks for each category from A to E as summarized in the following notes.

Category A

- i) Usually contains more than 20% solids.
- ii) Very rapid cake formation (2-in. cake thickness in a few seconds).
- iii) Fast-settling (cannot be kept in suspension by a conventional drum filter agitator).
- iv) Cake is difficult to pick up from the filter tank and retain on the drum by vacuum.
- v) Continuous filter rates are 500 lb or more dry solids/hr per sq ft of filter area.

When large-scale continuous filtration is desired, the porosity of the cake from a slurry in this category determines whether it can be held by vacuum on the drum of an internal-feed drum filter or on a top-feed unit. If not, the hopper dewaterer or one of the horizontal types is indicated. High washing or wash separation requirements indicate a horizontal type.

For small-scale production, batch vacuum filters of the nutsche type are often used for this type of slurry, and if pressure is required, an enclosed nutsche or horizontal plate pressure filter can be used. For large-scale production requiring pressure, some other type such as the continuous centrifuge should probably be selected. However, any of the vacuum filters suitable for this type of slurry can be designed with a pressure closure.

Other methods of solid-liquid separation such as centrifuging, screening, or even settling and draining are superior to or competitive with filtration for this category.

Category B

- i) Usually has more than 10-20% solids.
- ii) Rapid cake formation (1/2 in. thick in 2 minutes or less up to 2 in. thick in 30 sec).
- iii) Fast-settling, but can be kept in suspension by a standard drum filter agitator.
- iv) Cake can be picked up and held on the drum by vacuum.
- v) Continuous filter rates are between 50 and 500 lb of dry solids/hr per sq ft of filter area.

For continuous large-scale vacuum filtration, the conventional multiple-compartment drum filter is usually the most economical choice. If wash or wash separation requirements are high, alternatives may be justified. If wash requirements are low, the continuous vacuum disc filter may be more economical than the conventional drum.

For small-scale production, batch vacuum nutsches and batch pressure filters are often used for slurries in this category. Where pressure is required, the type of filter used depends upon the allowable method of cake discharge and the scale of production. For high production rates with

pressure operations, a continuous pressure drum or a continuous pressure disc unit may be used depending on wash requirements.

Centrifuging and screening must always be considered for this category.

Category C

- i) The concentration of solids is from 1 to 10% or more.
- ii) Slow cake formation (at least 1/8 in. thick in 3 minutes up to 1/2 in. thick in 2 minutes).
- iii) Cakes are usually thin and difficult to discharge from a continuous filter. This occurs either because only a very thin cake can be formed in a reasonable time or because much higher filtration rates are obtained with a thin cake.
- iv) Continuous filter rates are in the range 5-50 lb dry solids/hr per sq ft of filter area.

For continuous large-scale vacuum filtration, the conventional multiple-compartment drum filter is usually the most economical choice. The single-compartment drum is superior for discharging very thin cakes and where high washing efficiency and sharp wash separation are required. The continuous disc filter may be more economical than the conventional drum type if wash requirements are low.

For extremely high production requirements together with corrosive conditions and the necessity of producing a very strong filtrate with thorough cake wash, slurries from categories B and C are sometimes handled on batch vacuum leaf filters.

For small-scale production, nutsches and batch pressure filters can be used. If pressure is required, a pressure nutsche, horizontal plate or vertical leaf pressure filter, tubular element filter, or filter press may be used depending on scale of production and allowable method of cake discharge. For high production requiring pressure, the continuous pressure drum or continuous disc may be used.

Category D

- i) Solids concentration is less than 5%.
- ii) Normal settling and slow cake formation (1/8 in. thick in 5

minutes).

- iii) A dischargeable cake cannot form on a continuous filter in a reasonable time.
- iv) Batch filter rates are usually considerably less than 2 lb of solids/hr per sq ft of filtering area.

Continuous vacuum or pressure precoat operation is sometimes justified in this case for large-scale production. Otherwise, batch pressure methods are indicated, with the choice depending primarily on the scale of production, permissible cake discharge methods, wash requirements, etc.

Category E

- i) Solids concentration is less than 0.1%.
- ii) No cake formed during filtration.

Solution clarification rather than cake filtration is involved and solution viscosity and particle size have more influence. For relatively coarse particle-size separation (5 microns or more), continuous or batch precoat filters, filter presses, horizontal plate filters, edge or cartridge filters are used depending upon production level. For high-viscosity solutions, presses or cartridge filters are most suitable.

For fine separations (< 5 microns) from low-viscosity solutions, precoated batch pressure filters are often used. At high production levels, continuous vacuum or pressure precoat filters can often be justified. High-viscosity solutions containing solids below 5 microns usually require a precoated plate and frame filter press.

TABLE 1
Appropriate Filter Types for Slurry Categories A to E

Specific Equipment	Slurry Category				
	A	B	C	D	E
<u>Batch Filters</u>					
<u>Gravity:</u> Shaking screens	x	x			
<u>Vacuum:</u> Nutsche	x	x	x	x	x
Leaf		x	x		
<u>Pressure:</u> Plate & frame		x	x	x	x
Vertical leaf		x	x	x	x
Tubular element		x	x	x	x
Horizontal plate	x	x	x	x	x
Cartridge, edge	x	x	x	x	x
<u>Centrifugals</u>	x	x			
<u>Continuous Filters</u>					
<u>Vacuum</u>					
Rotary drum					
External bottom-feed		x	x		
External top-feed	x	x			
Hopper dewaterer	x	x			
Precoat				x	x
Internal	x	x			
Rotary disc		x	x		
Rotary horizontal	x	x			
<u>Pressure</u>					
Drum		x	x		
Precoat				x	x
Disc		x	x		
<u>Centrifugal</u>	x	x			

REFERENCES

1. Coulson, J.M. and Richardson, J.F. "Chemical engineering-unit operations"; Pergamon, Oxford; v. 2; 1959.
2. Dickey, G.D. "Filtration"; Chem. Eng. Series; Reinhold Pub. Corp., New York; 1961.
3. Matler, S.A. "Chemical filters, many types meet industry's varied demands"; Chem. Inds; v. 66, pp 38-48; 1950.
4. Taggart, A.F. "Handbook of mineral dressing"; John Wiley & Sons, Inc. New York; Section 16, p 19; 1945.
5. "Continuous vacuum and pressure filters"; Eimco Corp; Bull. no. F-2049.
6. Purchas, D.B. "Filtration in chemical and process industries"; Filtration and Separation; v. 1, no. 6, pp 316-320; 1964.
7. Salter, K.C. and Hosking, A.D. "Chemical engineering practice fluid systems"; Butterworth Sci Pub.; v. 6, p 487; 1958.
8. Perry, John H. "Chemical engineers' handbook"; Ed. R.H. Perry; McGraw-Hill, New York; 3rd Ed; 1950.
9. "Unifloc vacuum filter"; Unifloc Ltd, Swansea, U.K.
10. Reed, G.G. "Continuous and batch filters"; Chem. Eng.; v. 65, no. 12, pp 160-163; 1958.
11. Longueville, A. "The tubular steam-heated rotary dryer and the string-discharge drum filter"; 3rd Int. Coal Prep'n Cong., Liege; Paper E7; 1958.
12. "Eimcobelt (continuous belt) filter"; Eimco Corp; Bull. no. F-2067A.
13. "New Eimcobelt filter"; Eimco Corp.; Bull. no. F-2053.
14. Dahlstrom, D.A. and Cornell, C.F. "Improved equipment for vacuum filtration of sludge"; Sewage and Ind. Wastes; v. 30, pp 891-900; 1958.
15. Emmet, R.C. and Dahlstrom, D.A. "Top feed filtration and drying"; Chem. Eng. Progr; v. 57, no. 7, pp 63-67; 1961.
16. Riegel, E.R. "Chemical machinery - an elementary treatise on equipment for the process industries"; Reinhold Pub. Corp., New York; p. 283; 1944.

17. "Eimco vacuum or pressure precoat filters"; Eimco Corp.; Bull no. F-2022A.
18. "Simonacco rotary vacuum disc filter-standard dimensions and chart"; Simon Acco; Bull. no. SA 147.
19. Nordengren, S. "The horizontal filter"; Mining Mag.; v. 81, p 81; July 1949.
20. Jay, C.E. "Development of horizontal tipping tray filter"; Chem. Process Eng.; v. 45, no. 4, pp 180-182; 1964.
21. "Eimco tilting pan filter"; Eimco Corp., Bull. no. F-2038A.
22. Nickolaus, N. and Dahlstrom, D.A. "Theory and practice of continuous pressure filtration"; Chem. Eng. Progr.; v. 52, pp 87M-97M; 1956.
23. Trowbridge, M.E.O. "Centrifugal filters in the chemical industry"; Brit. Chem. Eng.; v. 1, no. 3, pp 148-151; 1956.
24. Dahlstrom, D.A. "Application of continuous filters in the metallurgical flowsheet"; Trans. Can. Inst. Mining Met.; v. 62, pp 26-43; 1959.
25. Smith, W.C. and Giesse, R.C. "Filtration equipment design"; Ind. Eng. Chem.; v. 53, pp 538-545; 1961.
26. Chalmers, J.M., Elledge, L.R. and Porter, H.F. "Filters"; Chem. Eng.; v. 62, no. 6, pp 191-216; 1959.
27. Grace, H.P. "What type filter and why"; Chem. Eng. Progr.; v. 47, no. 10, pp 502-507; 1951.

BATCH FILTERS

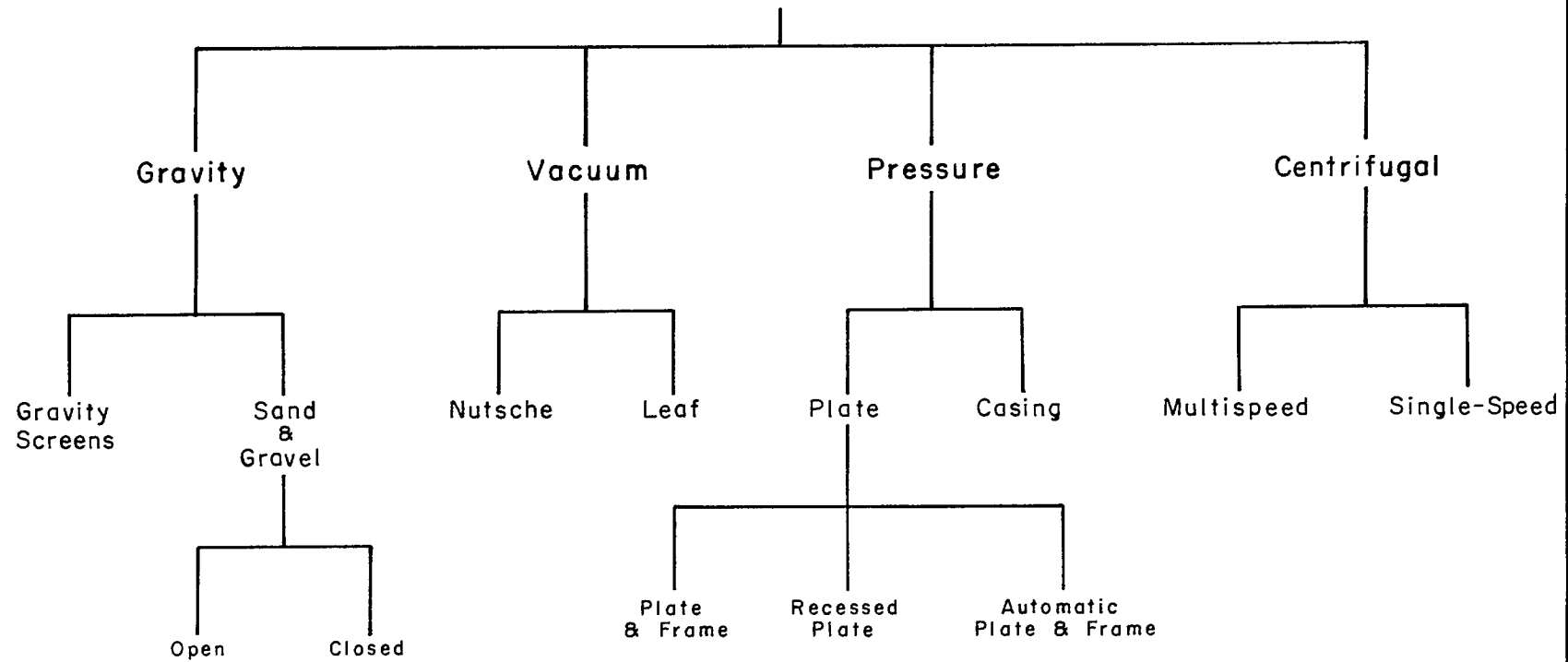

FIGURE 1. Batch Filters

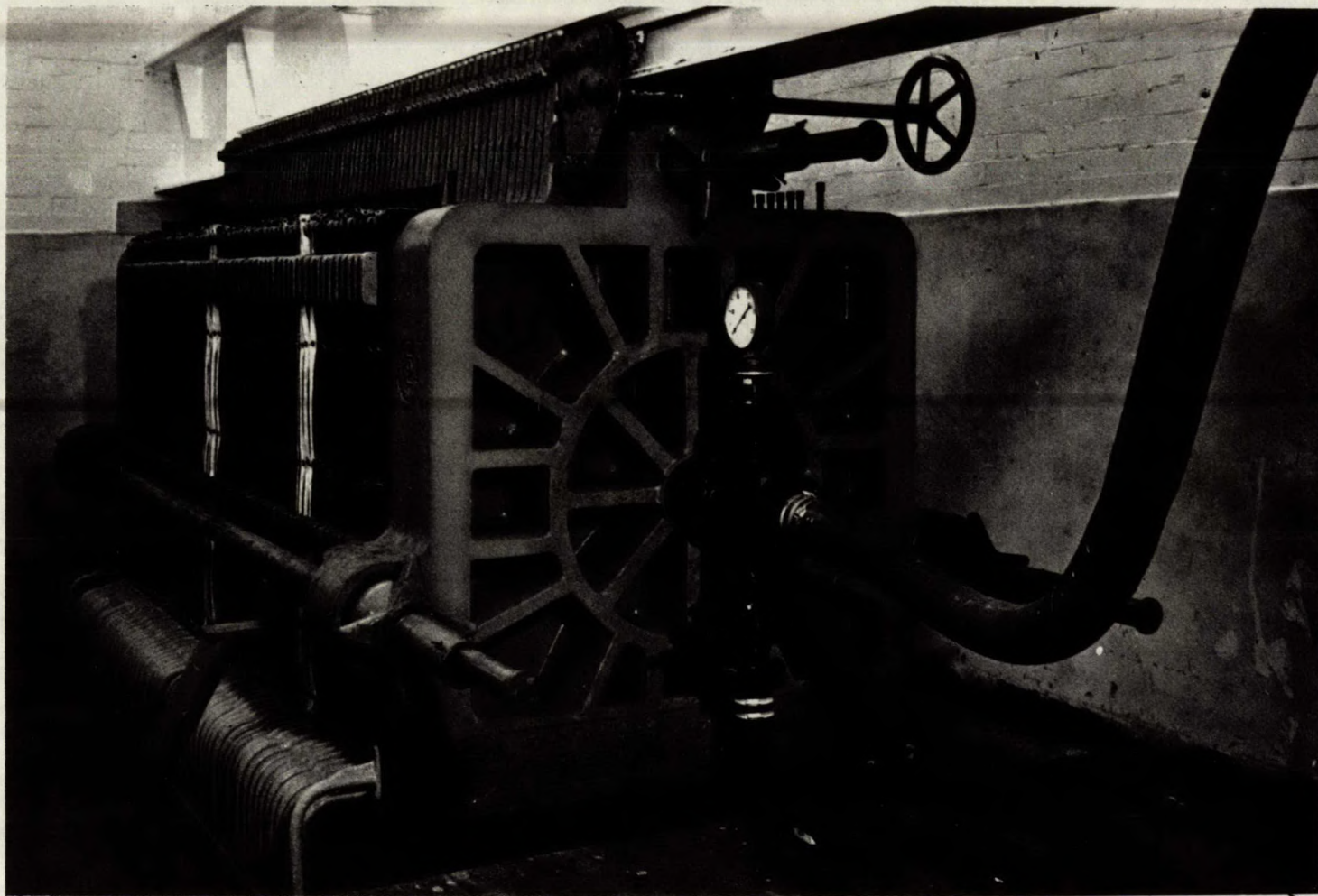

FIGURE 2. Plate and Frame Pressure Filter Assembly
(Courtesy of Johnson-Progress Ltd.)

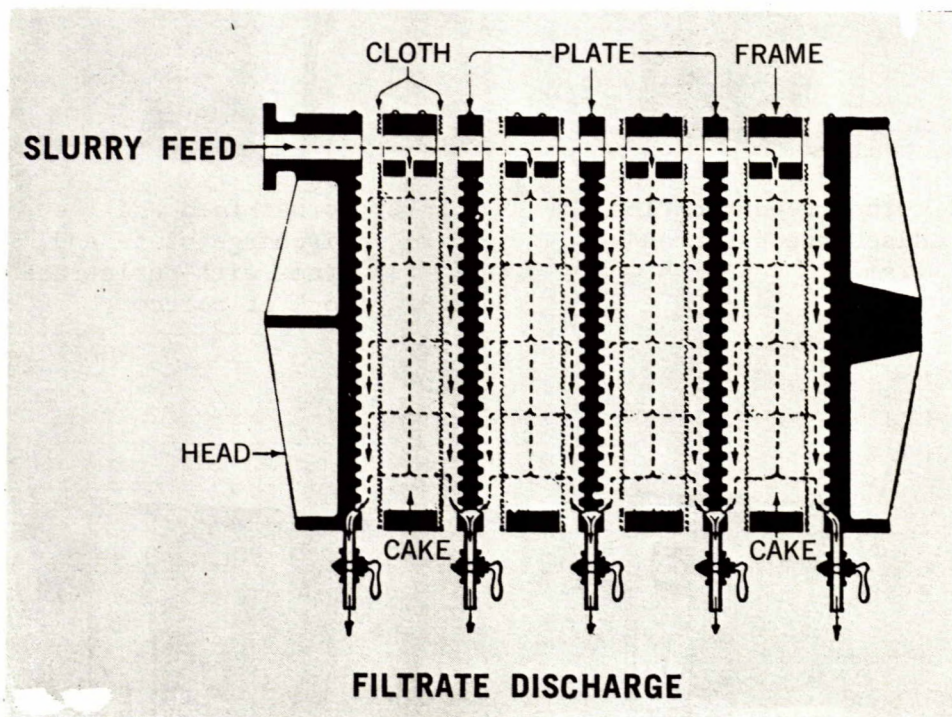
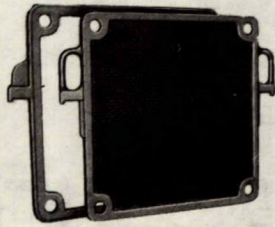
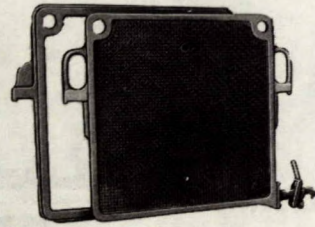

FIGURE 3. Shriver Plate and Frame Pressure Filter
(Courtesy of Envirotech)



a) Corner feed and closed discharge plate and frame



b) Corner feed and open discharge plate and frame with outlet and cock at bottom



c) Side feed and closed discharge plate and frame

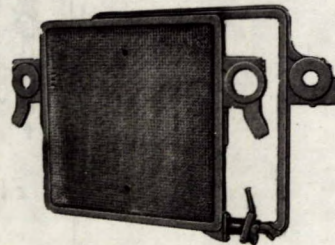

d) Side feed and open discharge plate and frame with outlet and cock at bottom

FIGURE 4. Plate and Frame Pressure Filter
(Courtesy of Envirotech)

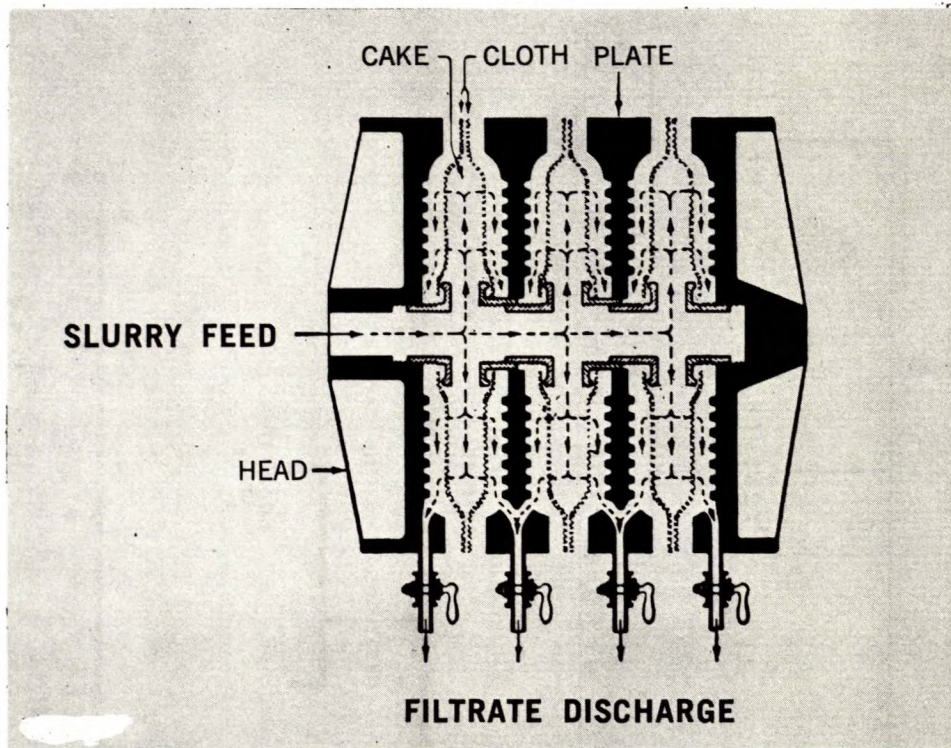
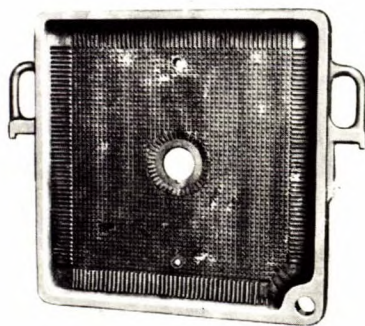
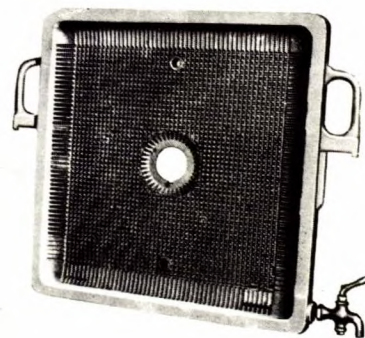

FIGURE 5. Recessed Plate or Chamber Pressure Filter
(Courtesy of Envirotech)



a) closed discharge



b) open discharge

FIGURE 6. Recessed Filter Plates
(Courtesy of Envirotech)

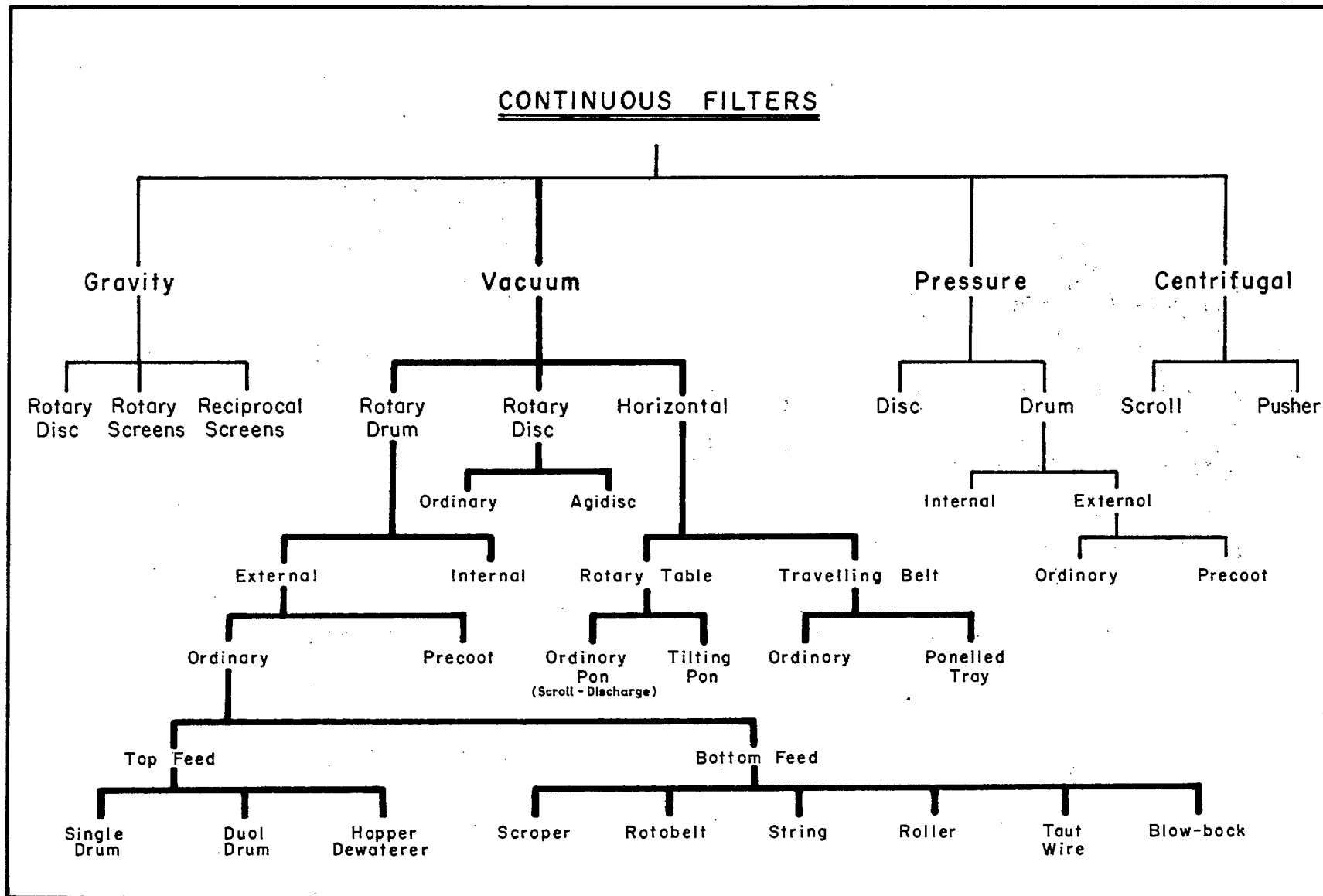

FIGURE 7. Continuous Filters

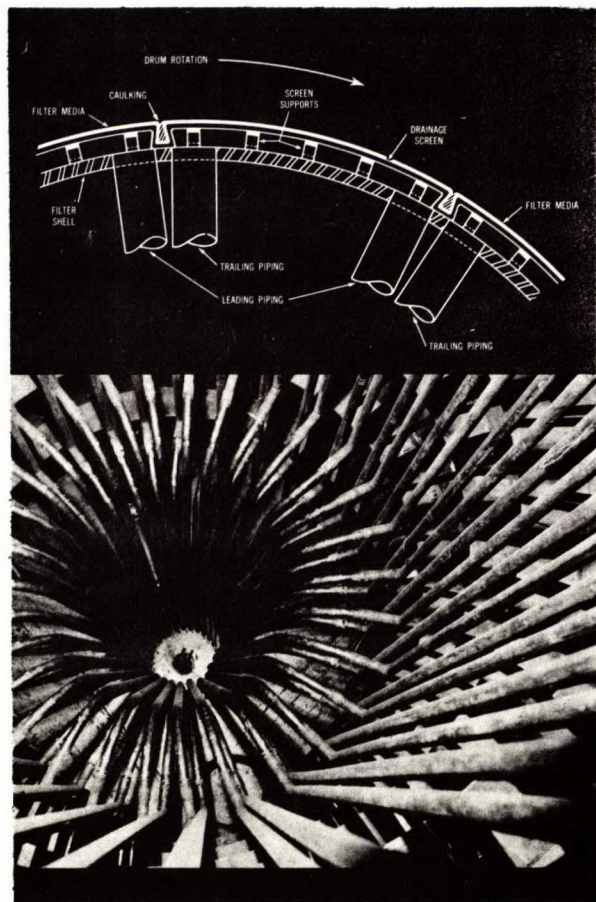

FIGURE 8. Internal Piping of a Rotary External Bottom Feed Vacuum Filter
(Courtesy of Dorr-Oliver)

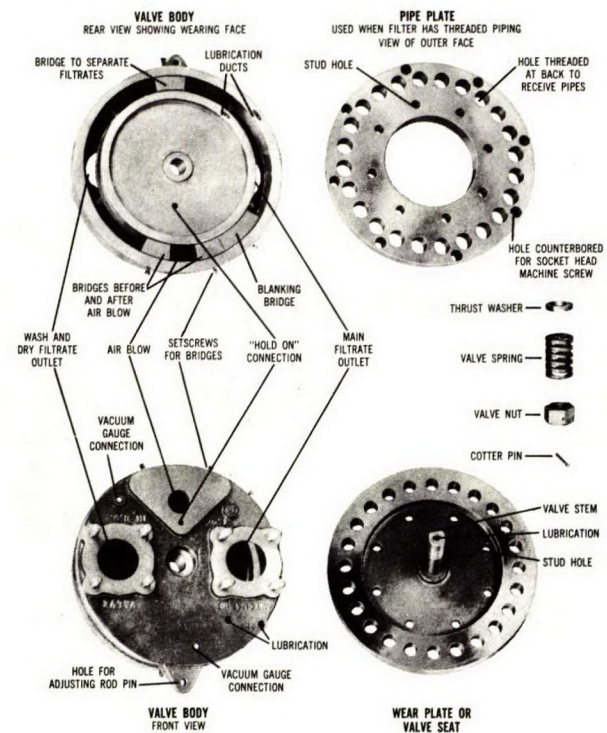
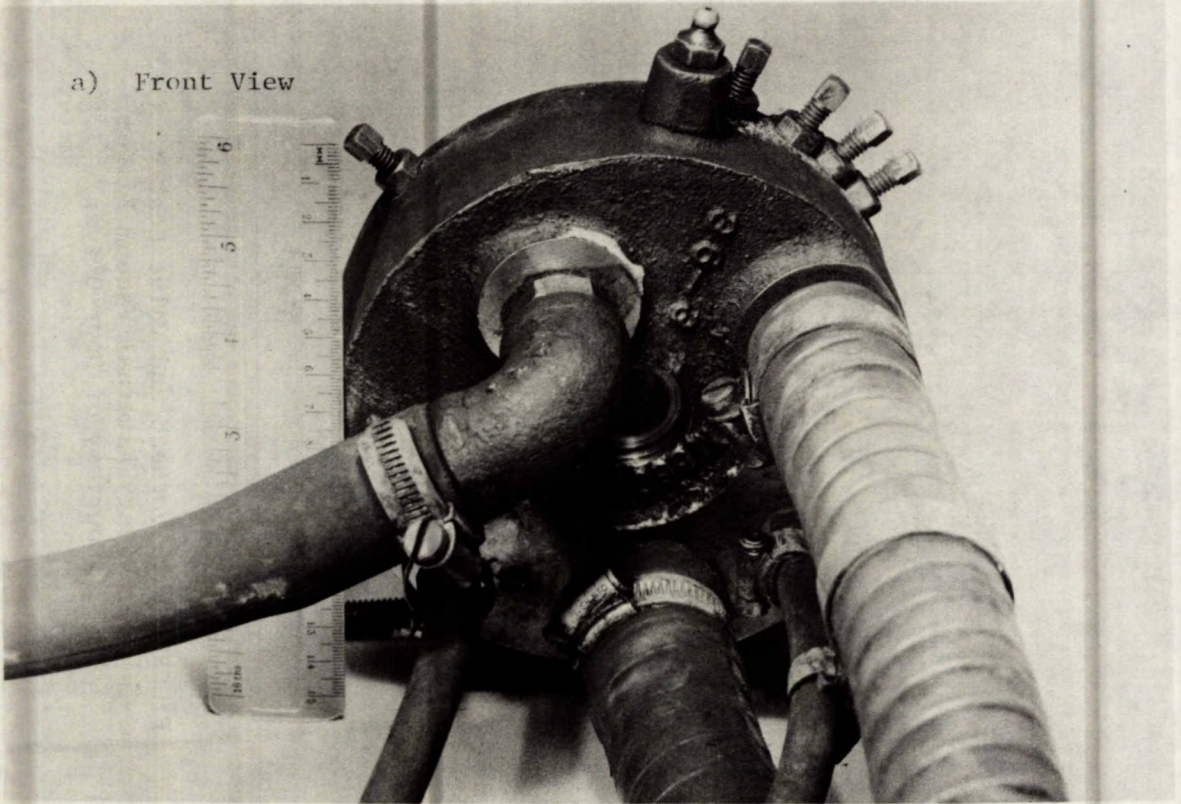

FIGURE 9. Valve Head and Valve Seat of a Rotary External Vacuum Filter
(Courtesy of Dorr-Oliver)

a) Front View



b) Rear View

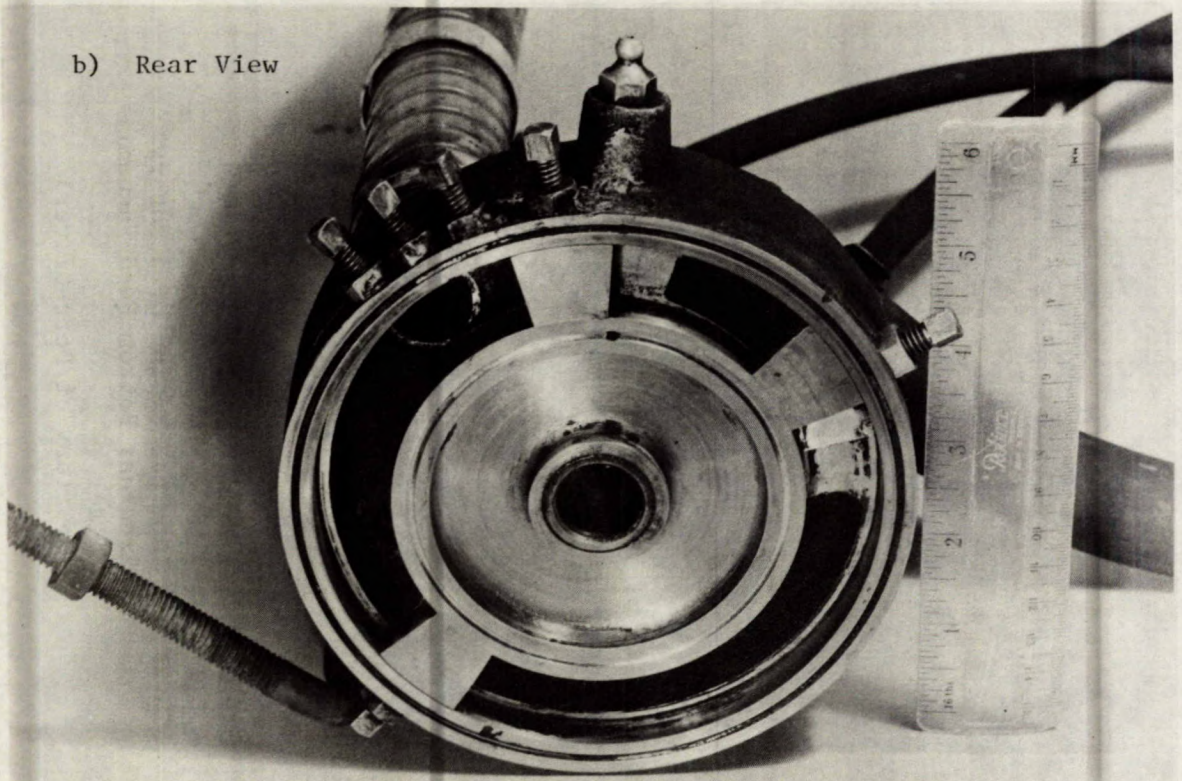
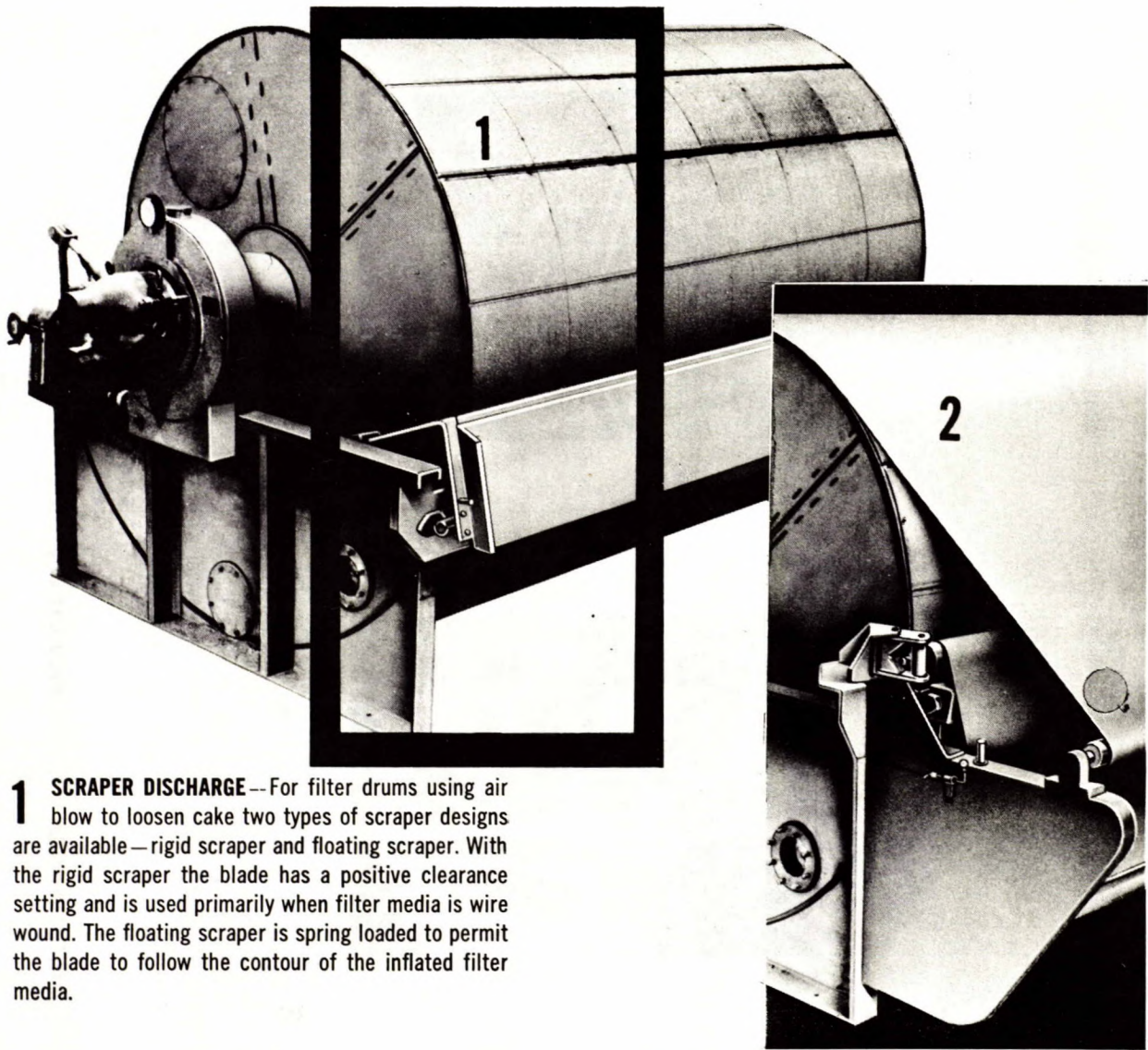

FIGURE 10. Valve Head of a Rotary External Vacuum Filter



1 SCRAPER DISCHARGE—For filter drums using air blow to loosen cake two types of scraper designs are available—rigid scraper and floating scraper. With the rigid scraper the blade has a positive clearance setting and is used primarily when filter media is wire wound. The floating scraper is spring loaded to permit the blade to follow the contour of the inflated filter media.

2 WEBTROL BELT DISCHARGE—Used when a dry cake discharge is required from materials having special discharge and cloth blinding problems. the Webtrol belt discharge consists of a complete roller assembly . . . bowed discharge roll, return and guide rolls along with wash and scraper mechanisms for cleaning the belt. An automatic edge sensing device provides positive control for tracking the belt.

FIGURE 11a. Drum Filter Discharge Mechanisms
(Courtesy of Dorr-Oliver)

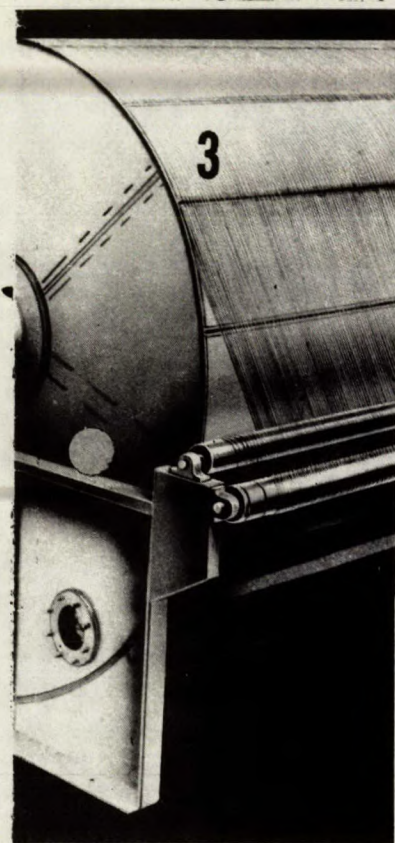

3 STRING DISCHARGE—The string discharge consists of a number of uniformly spaced strings which are carried completely around the filter drum and over discharge and return rollers. It is ideally suited for removal of filter cakes that are to be thermally dried. As the cake leaves the strings it breaks into small pieces providing more surface area for contact with the drier heat.

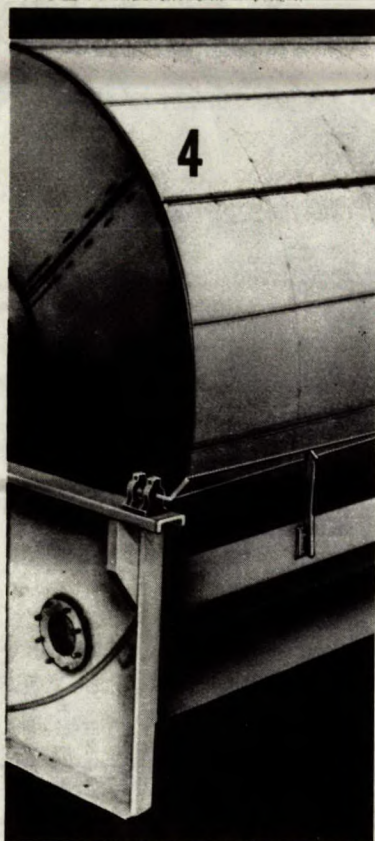

4 WIRE DISCHARGE—Consisting of a single or double strand of wire tautly stretched across the face of the drum, the wire discharge is employed where sticky, difficult-to-discharge cakes are encountered. The cake is lifted from the drum, thus avoiding smearing.

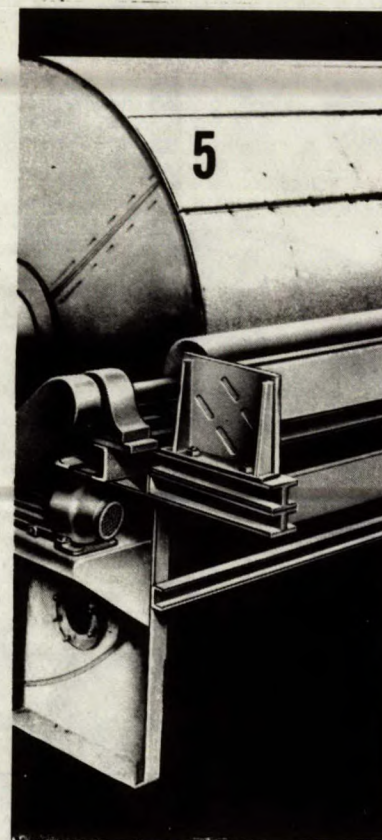

5 ROLL DISCHARGE—Where thin, highly adhesive cakes are formed, a roll discharge may be used to great advantage. The roll is a driven floating type and has a smooth or serrated surface to promote adherence of cake. As the vacuum in the drum is released, the cake adheres to the roll and is discharged by a scraper blade resting against the roll. Cakes as thin as $1/32$ of an inch can be fully discharged.

FIGURE 11b. Drum Filter Discharge Mechanisms (continued)
(Courtesy of Dorr-Oliver)

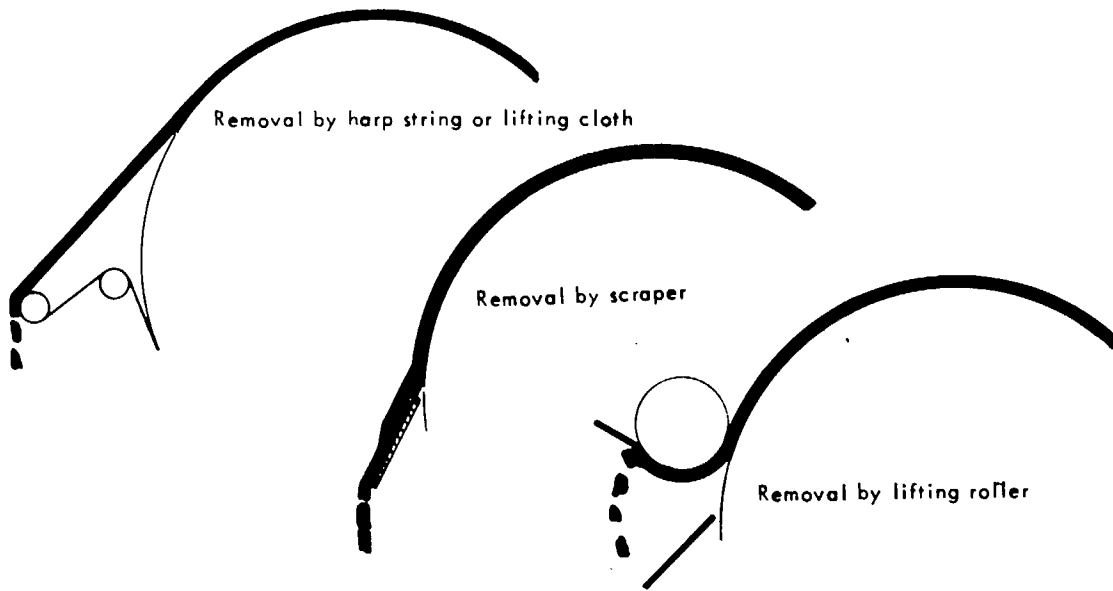

FIGURE 12. Schematics of some Drum Filter Discharge Mechanisms

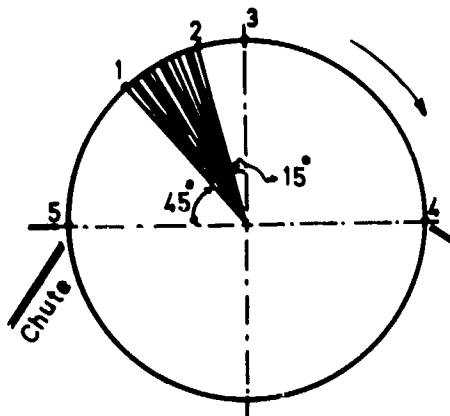

FIGURE 13. Ordinary Top Feed Filtration Cycle for Vacuum Drum Filter

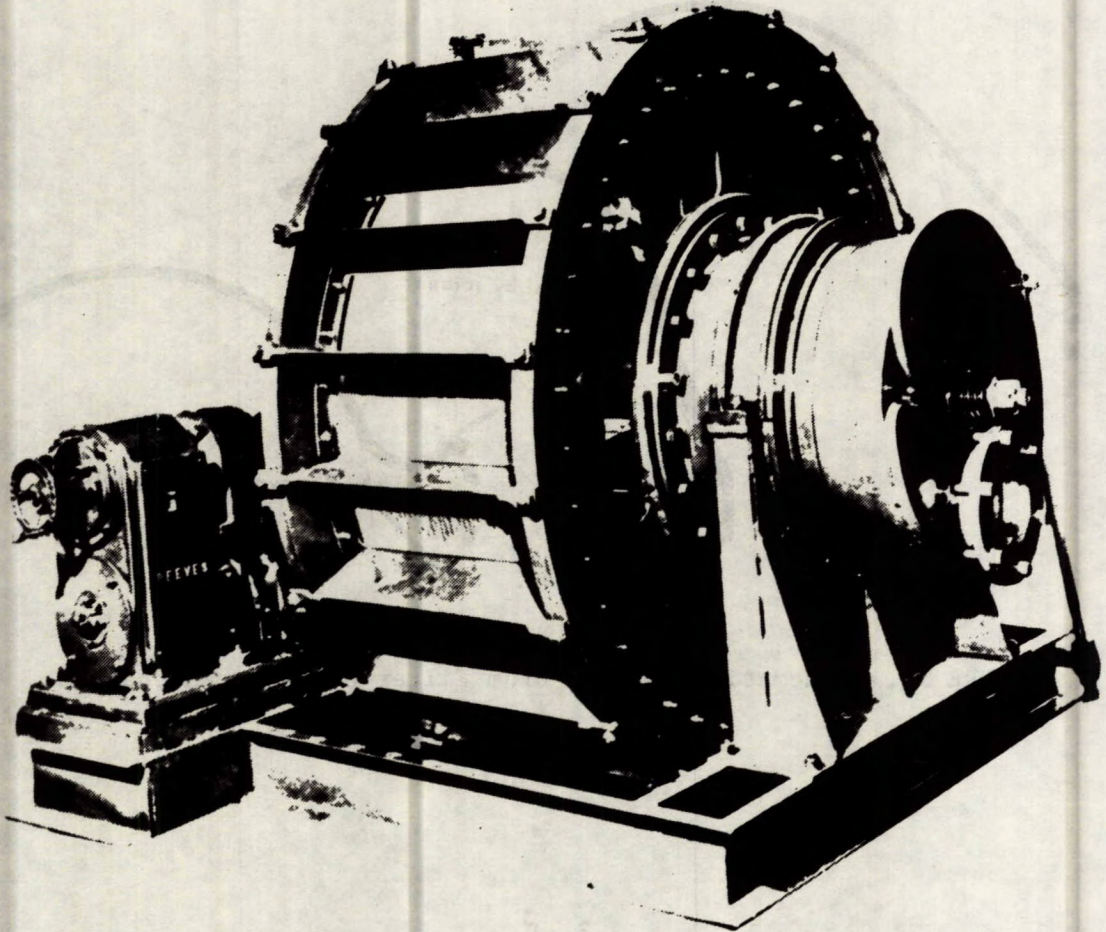
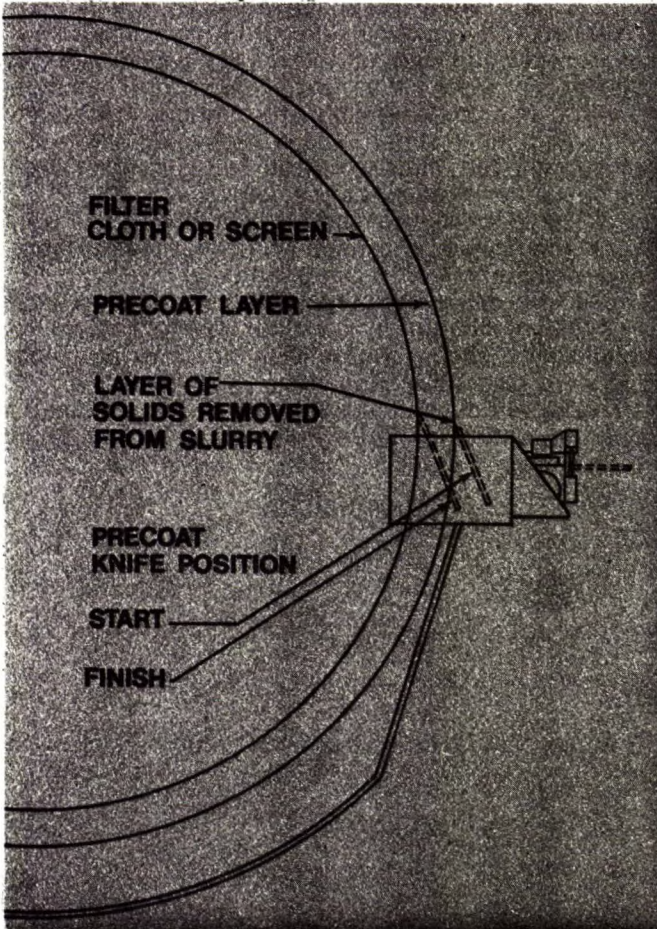
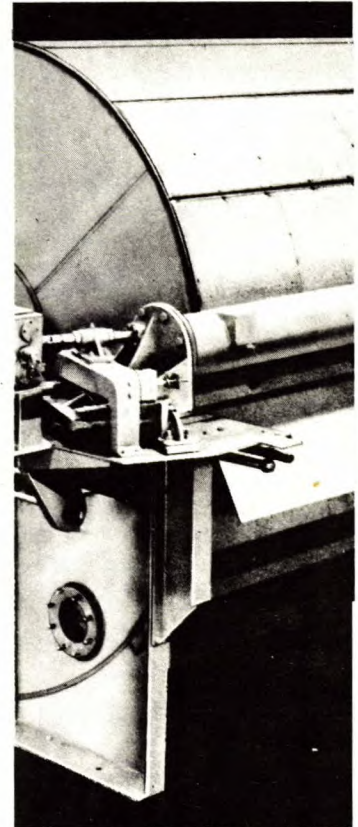

FIGURE 14. Hopper Dewaterer



a) Precoat Knife Arrangement
(Courtesy of Envirotech)



b) **PRE-COAT SCRAPER DISCHARGE**—Used in conjunction with a pre-coat filter media, the pre-coat scraper has a knife edge sharpness that allows it to move against the pre-coat layer with micrometer accuracy. Cuts from 0.0005 to 0.006 of an inch are possible. The scraper is equipped with a safety limit switch that actuates an alarm and stops scraper advance when the pre-coat layer has been reduced to a predetermined level. Special design permits pre-coat thickness up to 6 inches.

(Courtesy of Dorr-Oliver)

FIGURE 15. Precoat Vacuum Drum Filter Discharges

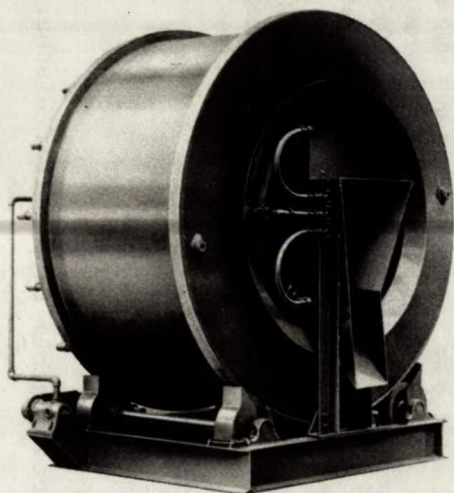
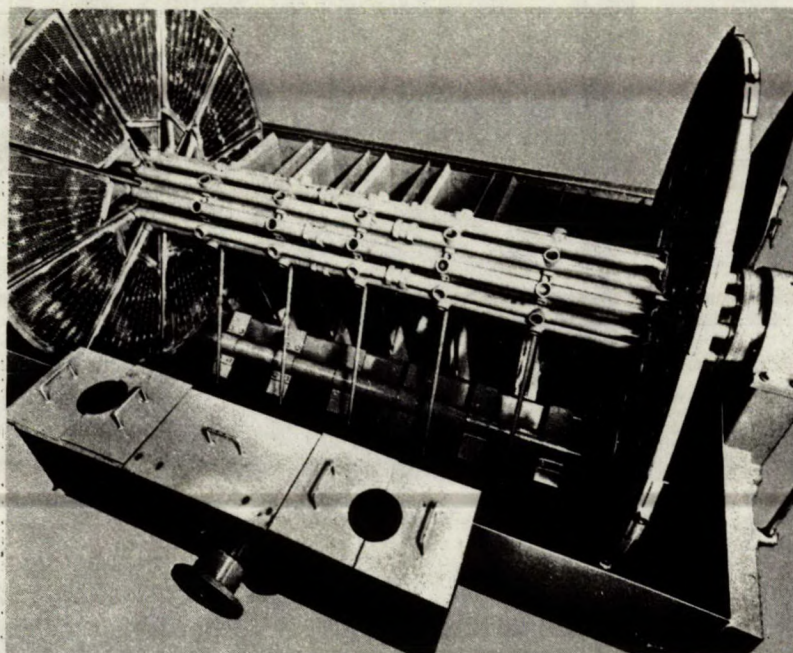
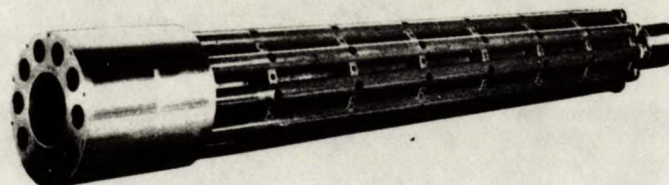

FIGURE 16. Internal Filtering Surface
Drum Vacuum Filter
(Courtesy of Dorr-Oliver)



a) Filter assembly showing paddle type agitator,
disc sectors and centre shaft.



b) Close-up of centre shaft

FIGURE 17. Rotary Vacuum Disc Filter
(Courtesy of Dorr-Oliver)

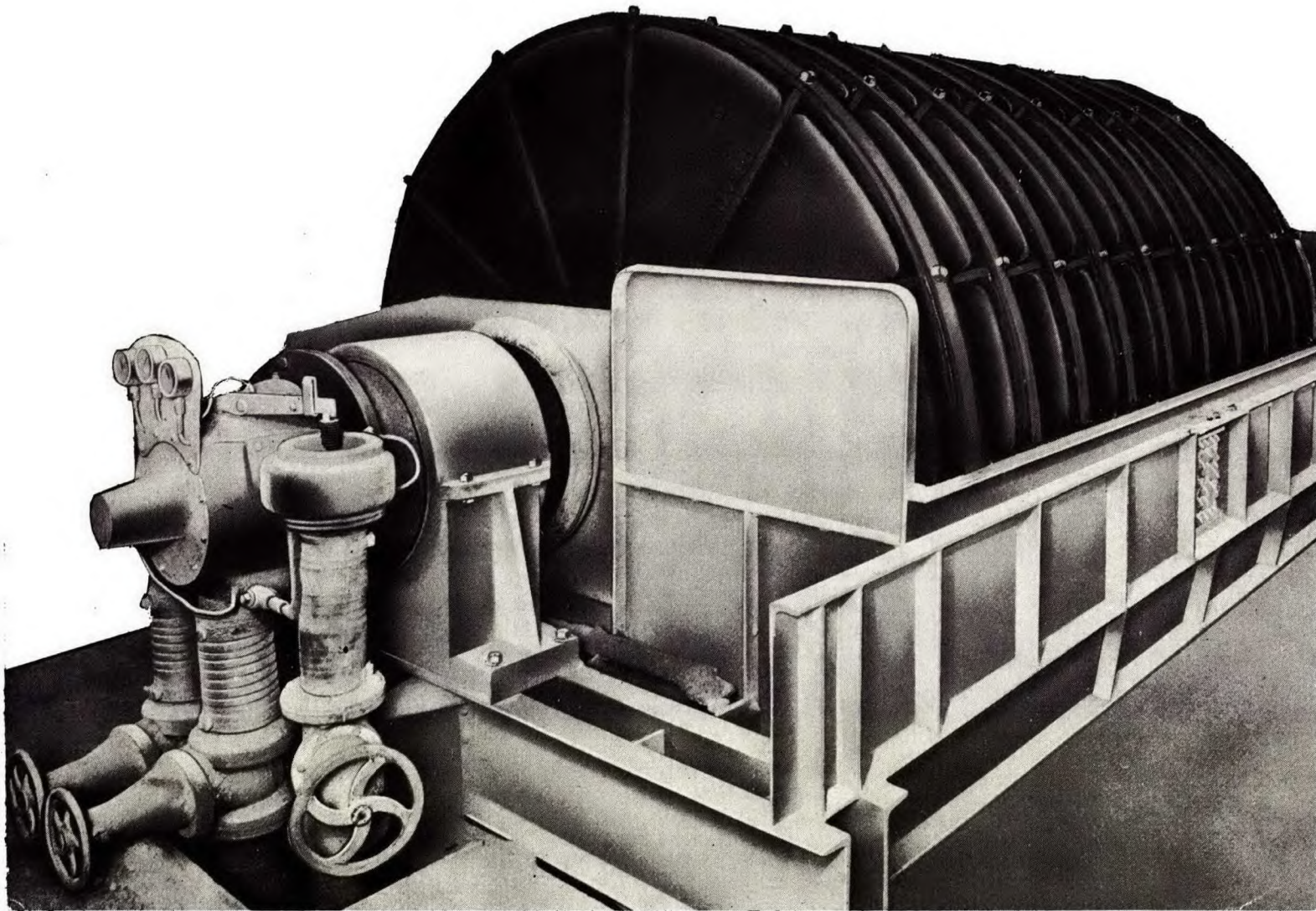

FIGURE 18. Rotary Vacuum Disc Filter
(Courtesy of Simonacco)

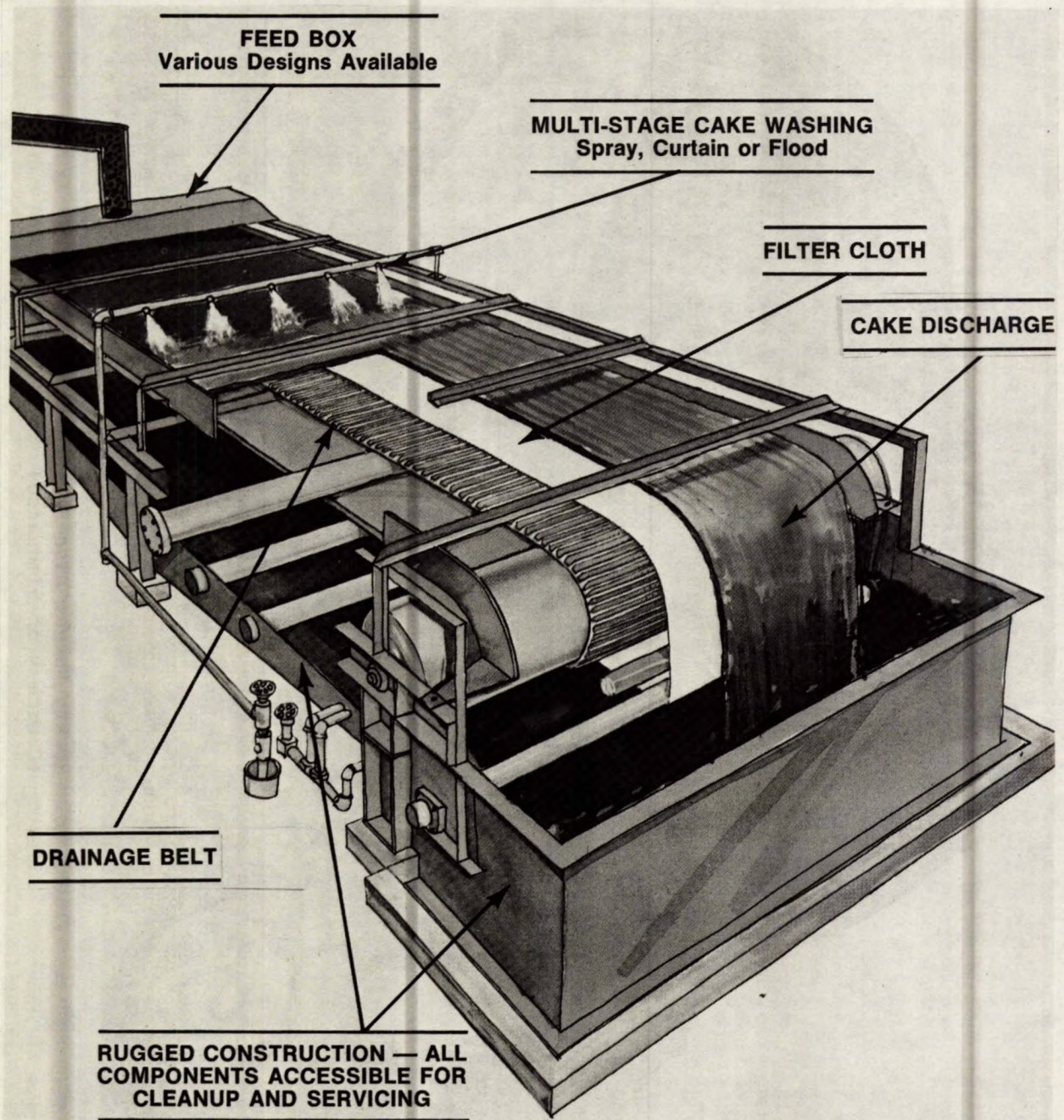

FIGURE 19. Ordinary Rubber Belt Filter
(Courtesy of Envirotech)

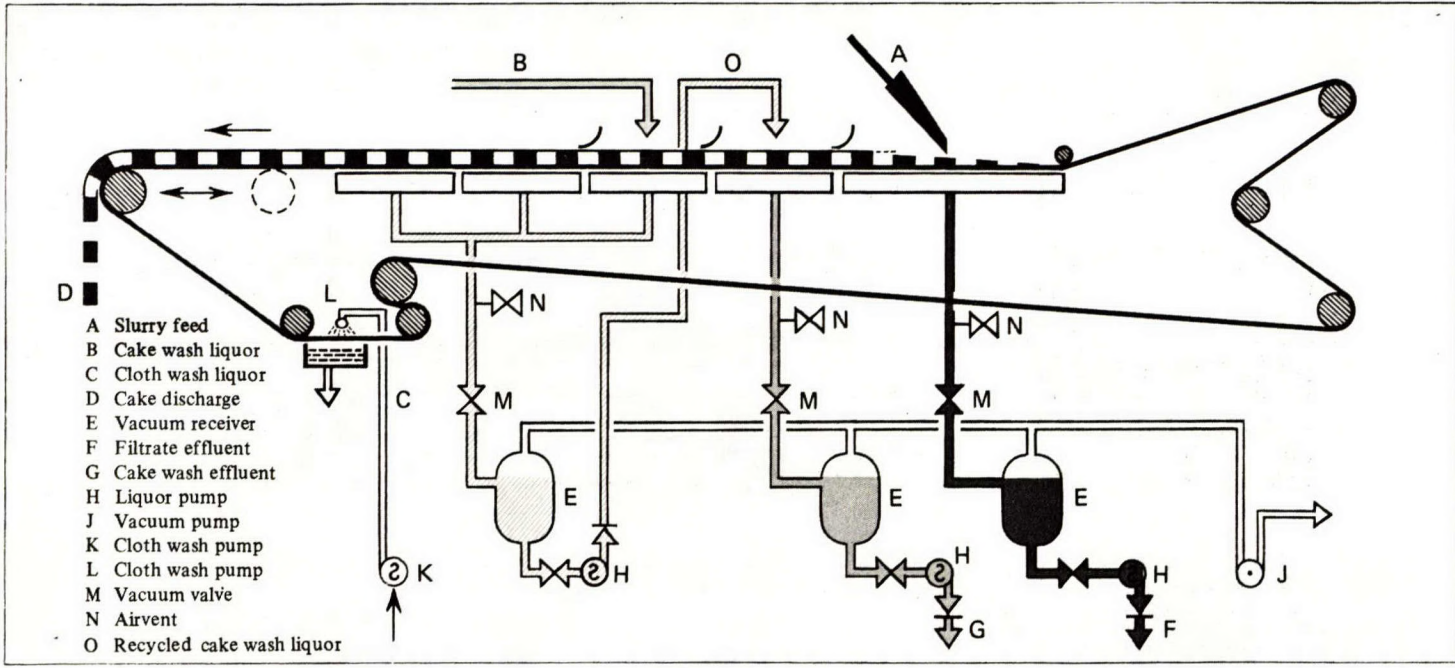
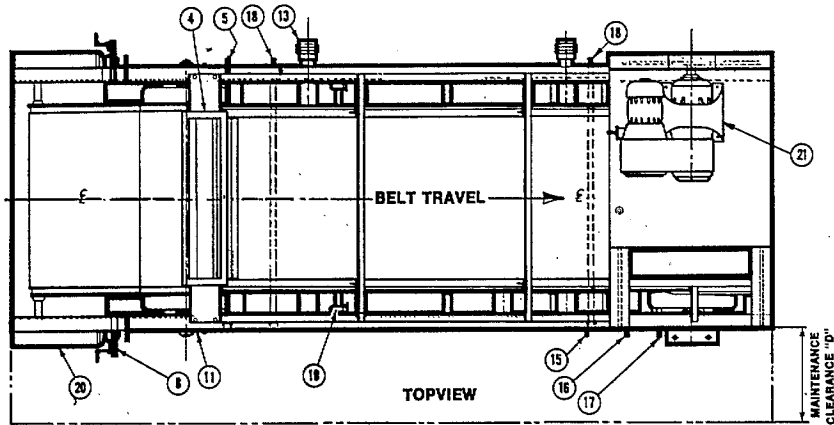

FIGURE 20. Flow Diagram of Ordinary Rubber Belt Filter with Washing
(Courtesy of Johnson-Progress Ltd)



1. Cake Discharge
2. Vent (Optional)
3. Hood (Optional)
4. Feed box
5. Inside belt wash and lubrication
6. Drainage belt
7. Drainage Belt take-up
8. Filter Cloth Aligning Mechanism
9. Filter Cloth
10. Drip pan
11. Calibrated Tensioning Device
12. Drip Pan Drain
13. Vacuum Manifold
14. Vacuum Pan
15. Outside Filter Cloth Wash
16. Outside Drainage Belt Wash and Collection Trough
17. Inside Filter Cloth Wash
18. Cake Wash Pipe, Location Adjustable
19. Drainage Belt Aligning Assembly
20. Filter Cloth Take-up Assembly
21. Variable Speed Filter Drive

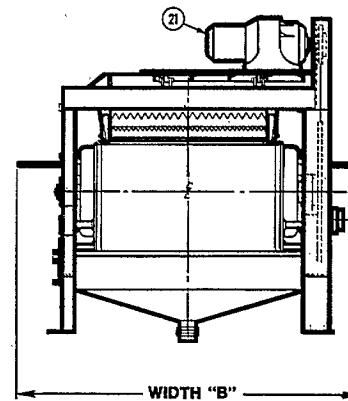
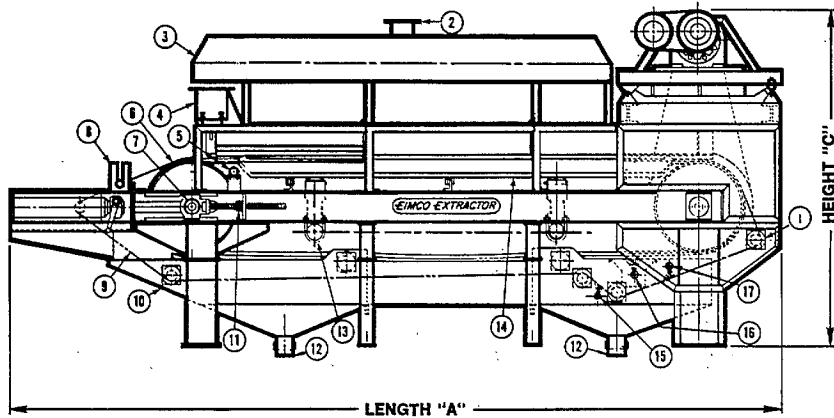

FIGURE 21. Ordinary Rubber Belt Filter
(Courtesy of Envirotech)

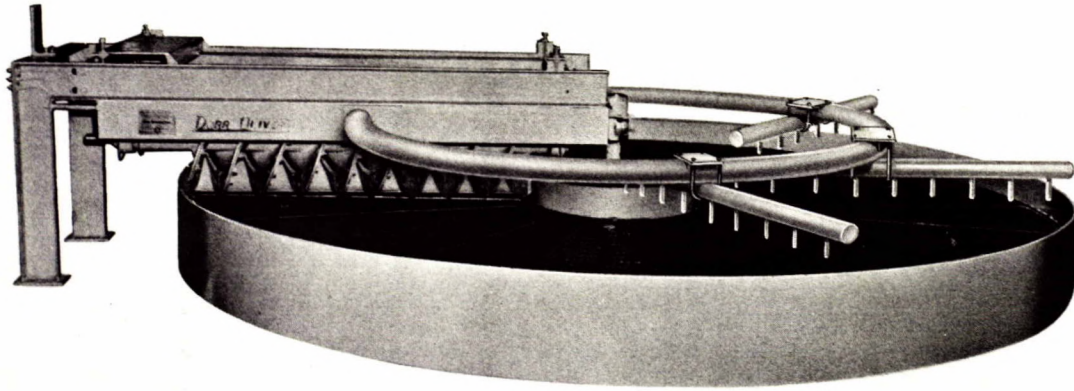

FIGURE 22. Ordinary Pan Filter with Scroll Discharge
(Courtesy of Dorr-Oliver)

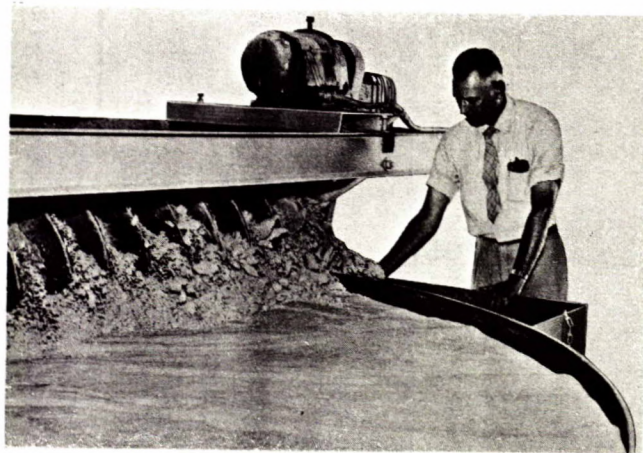
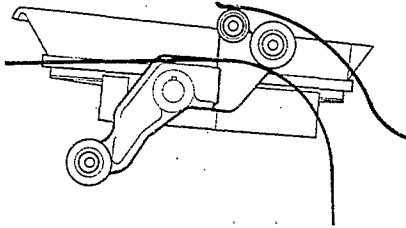
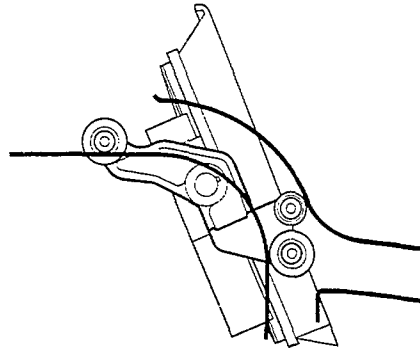

FIGURE 23. Scroll Discharge
(Courtesy of Dorr-Oliver)



Pan starts tilt when roller follows downward curvature of roller guide track.



As pan turns, vacuum holds cake to cloth, preventing cloth wear caused by sliding.

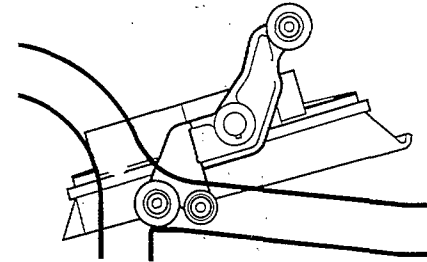

A snap air blow dislodges all cake from pan when pan is inverted.

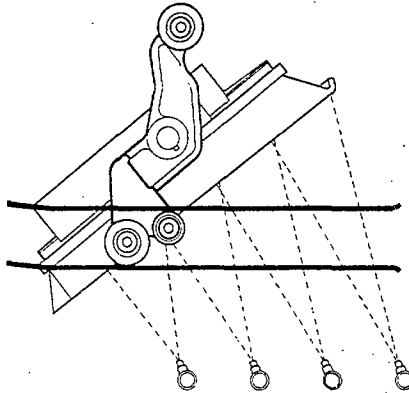

Cloth cleaning sprays wash cloth and pan thoroughly before pan returns to upright.

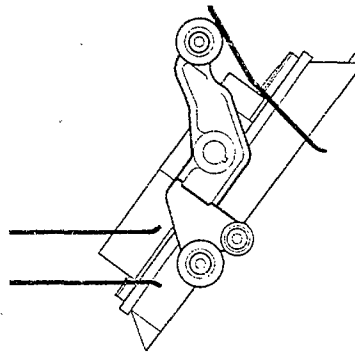

Vacuum purge removes cleaning water from pan corners, preventing dilution.

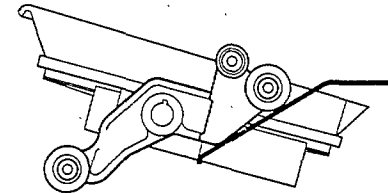

Roller, following track pattern, returns pan to upright, smoothly, quietly.

FIGURE 24. Tilting Pan Discharge Mechanism
(Courtesy of Envirotech)

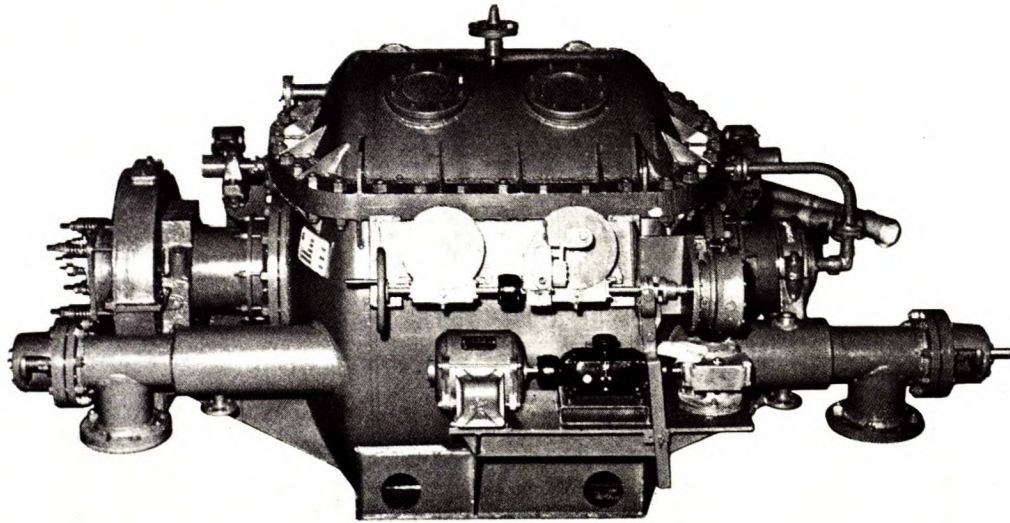

FIGURE 25. Continuous Pressure (Precoat) Filter
(Courtesy of Envirotech)

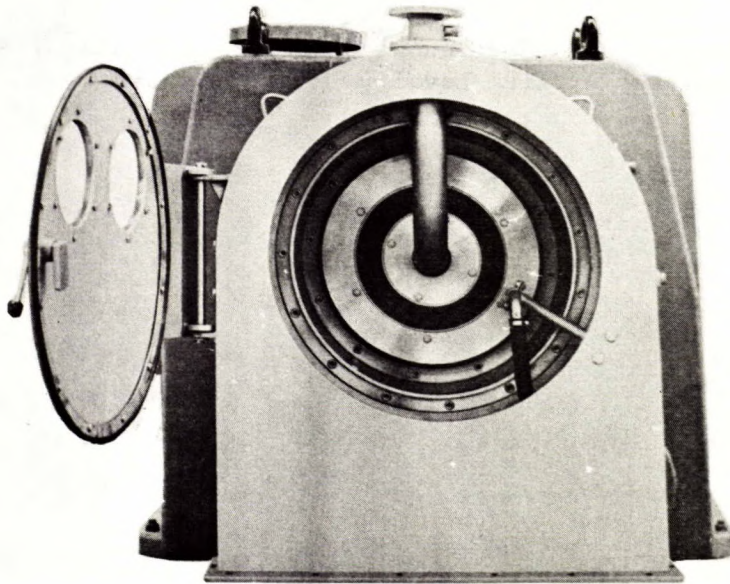

FIGURE 26. Continuous Centrifugal Filter (Pusher
Type) Rear View
(Courtesy of Alfa-Laval)

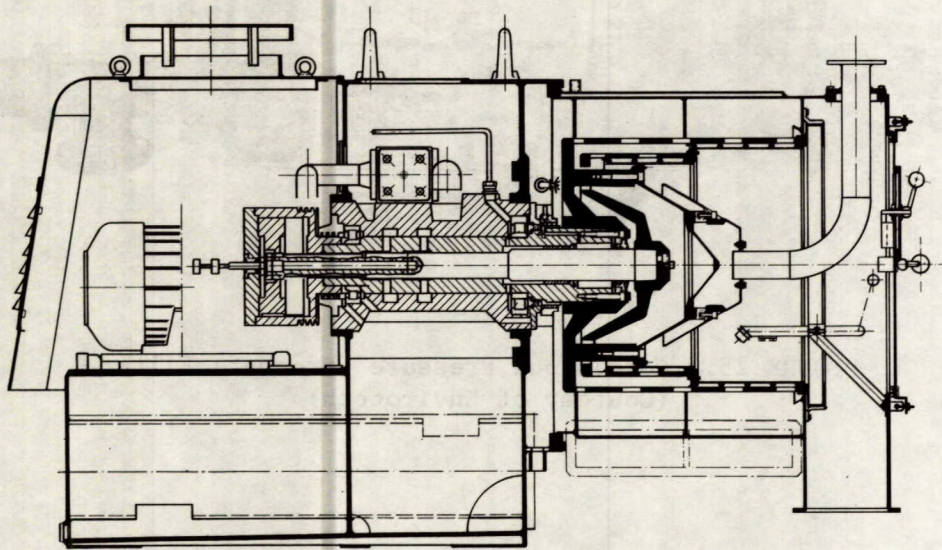
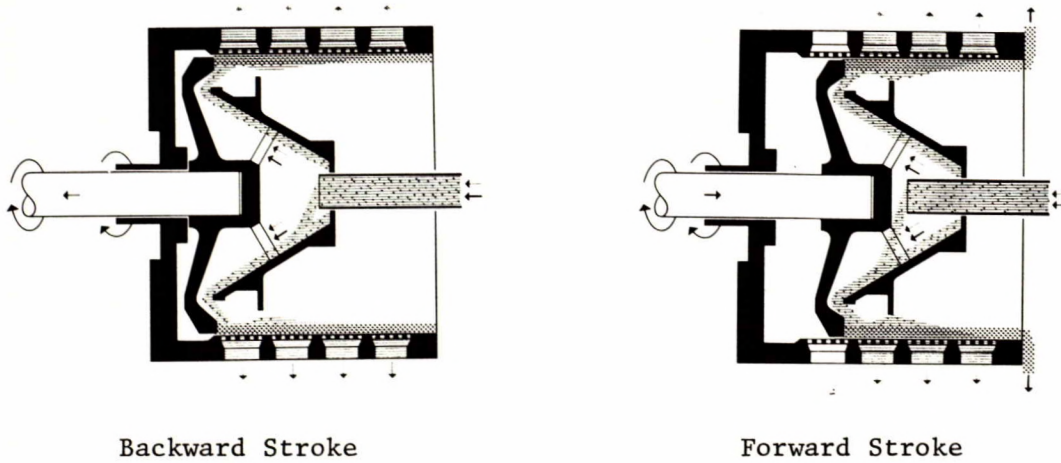

FIGURE 27. Assembly of a Continuous Centrifugal Filter (Pusher Type)
(Courtesy of Alfa-Laval)

a) Working Principle, single-stage model



b) Working Principle, two-stage model with washing device

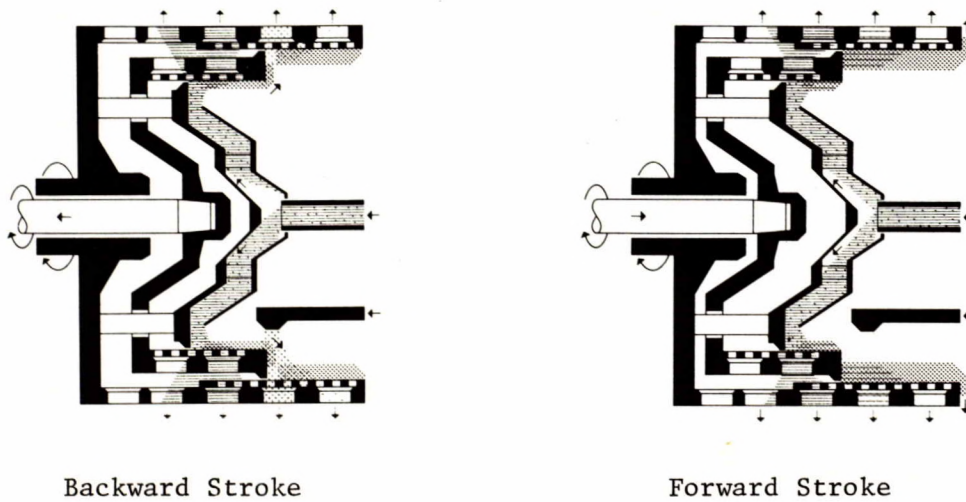
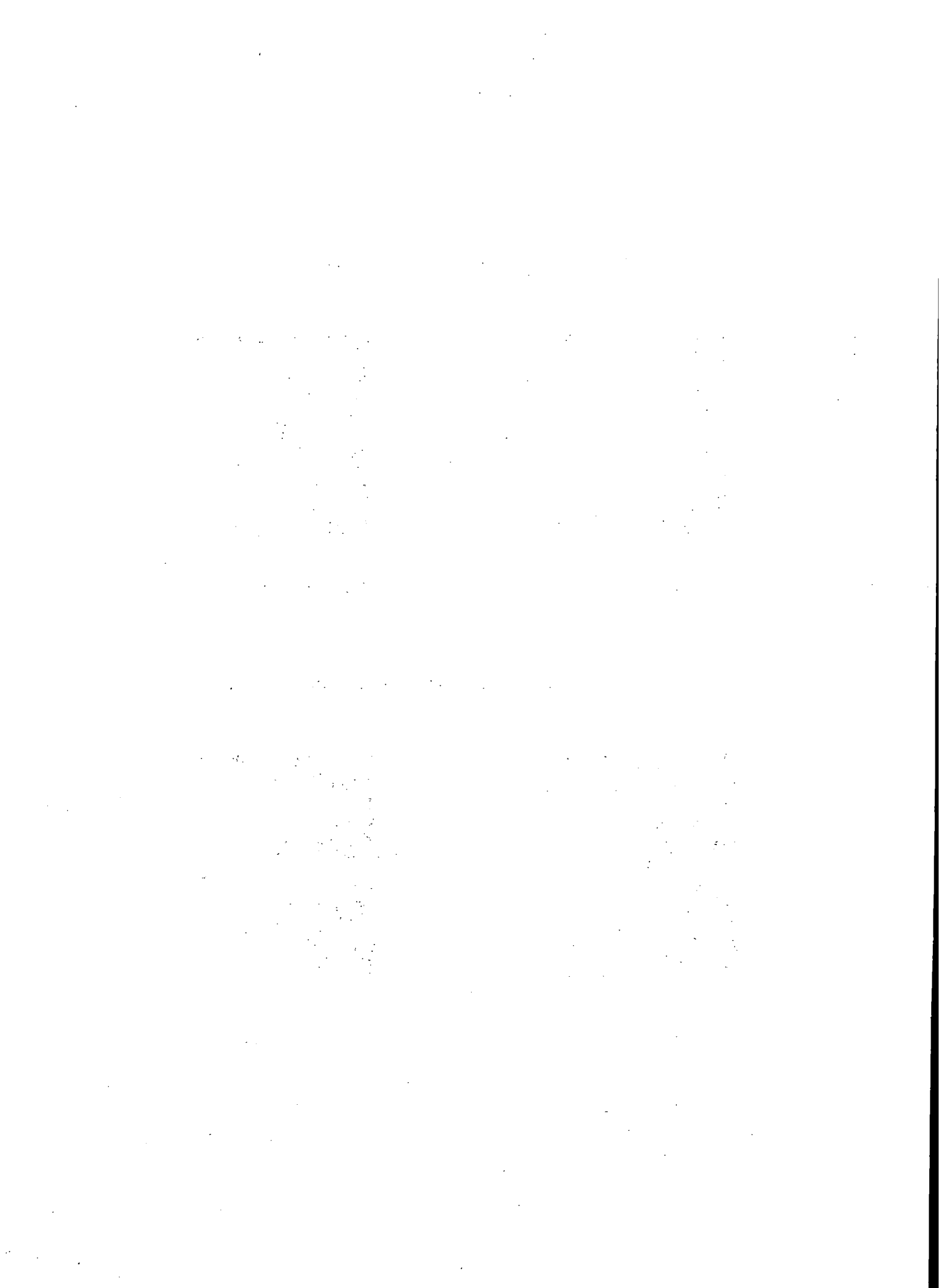
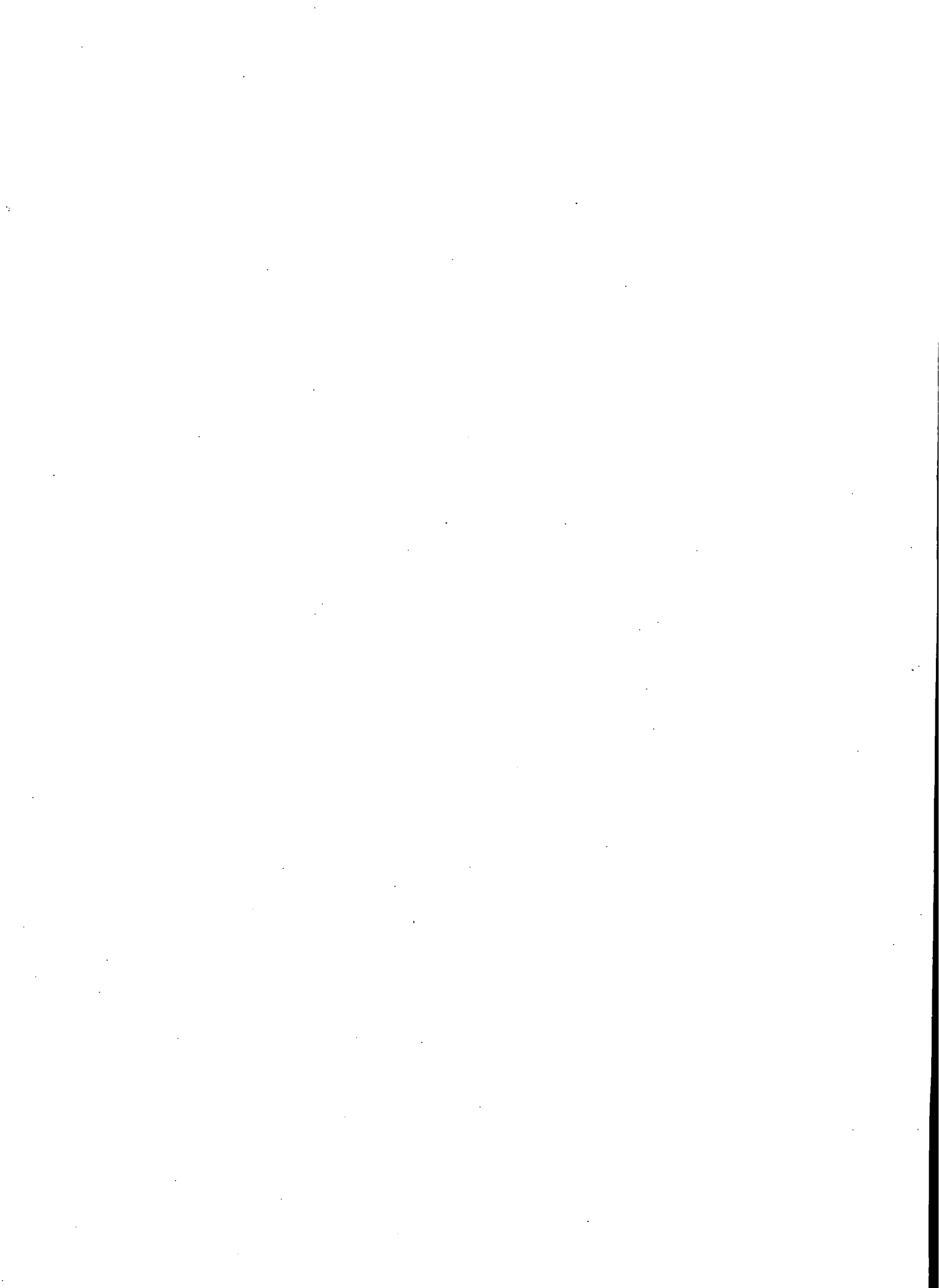

FIGURE 28. Continuous Centrifugal Filter (Pusher type)
(Courtesy of Alfa-Laval)



CHAPTER II - FILTER MEDIA



INTRODUCTION

Correct selection of medium is of prime importance in establishing efficient filter performance, since the properties of the filter medium will effect the outcome of the ultimate operation.

In terms of flow resistance, the medium should be considered as a composite of its permeable support and the initial layers of cake. However, considering the filter medium proper, Carman and others (1,2) showed that at low flow rates, the rate of flow of a fluid through a filter cloth is directly proportional to the pressure drop because of the existence of streamline conditions. On the other hand, at high flow rates and because of the existence of turbulent conditions, the rate of flow is proportional to the square root of the pressure. These conditions are not normally encountered in practice, however, and at low rates of flow some deviation from linearity is found with new or poorly supported media. This deviation is attributable to stretching and deformation and the effect does not occur with well-supported cloths and woven metals.

Resistance of the filter medium cannot normally be considered separately from the resistance of the initial layers of cake or from that of the permeable support and the piping. The synergetic resistance of the three together is usually greater than the sum of the individual resistances and it is therefore difficult to satisfactorily treat the flow problem of the medium from the theoretical point of view. In practice, the cloth and the initial layers of cake are usually regarded as being equivalent to a thickness of cake which will produce the same resistance (3).

TYPES OF FILTER MEDIA

The different types of filter media can be generally classified (4) as follows:

I. Rigid Filter Media

1. Loose: sand, diatomaceous earths, etc.
2. Fixed: aluminum oxide plates, perforated steel plates, etc.

II. Flexible Filter Media

1. Woven fabrics:

- a) Non-metallic: cotton, synthetics, glass, asbestos, rubber, silk, wool, plastics, etc.
- b) Metallic: wire cloths (bronze, lead, Monel, nickel, silver, stainless steel, etc.)
- c) Combination of non-metallic and metallic: asbestos and wire

2. Non-Woven Flexible Media:

- a) Preformed: paper, felts, etc.
- b) Non-preformed: asbestos, cellulose pulps, etc.

I. Rigid Filter Media

1. Loose

This type of medium is composed of individual particles which are rigid in structure and in only loose contact with one another. It has the advantage of being cheap and is easy to clean by rearranging the particles. The rate of flow through the particle bed may be regulated over extremely wide limits when proper particle size and shape are selected. The disadvantages of this type of medium are that it can be conveniently used only in a horizontal position and it permits neither removal of thick deposits without disturbing the filter bed nor surface cleaning except by back-washing.

This type may include: sand and gravel, diatomaceous earth, charcoal, precipitates or salts, coal and coke, and stones and brick.

2. Fixed

This type of medium is composed of firm, rigid particles, set in permanent contact with one another, either naturally as stoneware or artificially as bonded material. Such media have excellent void uniformity, resistance to wear, and ease in handling as piece units.

Although the natural porous materials were among the first media used, application was never very extensive and, with the advent of bonded fixed rigid media, the natural materials have been confined to special cases.

The artificial media have become increasingly important both as media supports, particularly in water-clarifying and filters, and as the medium itself (4). This type may include carbon, fused alumina, sintered metals (bronze, stainless steel, etc.) and glass.

II. Flexible Filter Media

1. Woven Fabrics

a) Non-metallic

Flexible woven non-metallic fabrics are widely employed and are fabricated in a variety of materials including cotton, synthetic materials, wools, silk, linen, jute, etc.

Filter media were limited to natural and fibrous filters prior to 1945 (5). In more recent years, most of the traditional natural fibres have been replaced by synthetic fibres and porous media which, because of their superior chemical, physical and thermal properties, provide reduced production and servicing costs.

A survey of most of the available woven textile filter media has been presented by Ehlers (5) and factors for selection are given in tabular form. In a comprehensive study in four parts, French (6) treated most aspects of filter media in detail and, in an important paper, Smith (7) discussed the physical properties of fabric filter media, their relationship to difficulties encountered in filtering operations and a description of the chief causes of these difficulties.

Yarn construction (4,6)

Woven fabrics are made from three different forms of yarns:

a) monofilament, b) multifilament, and c) spun-staple.

Monofilament - The fibre is made in a single, continuous filament and, when loosely woven, gives minimum blinding, excellent cake discharge, good cleaning and high flow rates. The turbidity of the filtrate is high however, and initial recirculation is usually necessary. There is a tendency towards loss of tensile strength and reduction in permeability when tightly woven.

Multifilament - This yarn is made by twisting two or more continuous monofilaments together. It has the greatest tensile strength and provides better cake discharge than the spun yarns. Excellent results have been obtained with high-twist multifilament synthetic yarn fabrics handling materials with particles in the sub-micron range. Good rates of flow can be maintained without clogging (4).

Spun-staple - These are made by twisting short lengths of natural or synthetic fibre into a continuous strand and, because of their hair-like filaments, are the best for particle retention. Good initial clarity and excellent gasketing properties are other characteristics.

Fabric construction (6)

Natural and synthetic fibres can be woven to obtain a large number of variations in weights and weave patterns. The four basic weaves which are commonly used are as follows:

Plain weave - This is the least expensive of the four weaves and has the lowest porosity. It possesses the greatest particle retentivity but is susceptible to rapid blinding. Easy cake removal is afforded by the plain weave fabrics because of the evenness of their surface. Plain weave filter media provide good sealing when used in filter presses.

Chain weave - This is a variation of twill weave. It has lower tensile strength and retentivity than the plain weave but has a greater resistance to blinding. Although slightly inferior to the plain weave, it affords excellent cake removal and provides good sealing when used in filter presses.

Twill weave - This weave has medium retentivity and blinding properties, but offers good flow rates and high resistance to abrasion. Cake removal is impeded more than with plain or chain weaves and sealing properties are poor because of the twill ridges.

Satin weave - This has the lowest particle retentivity of all the basic weaves, but offers superior cake release and the highest resistance to blinding.

Fabric finishing

Several finishing processes are available to improve the filtration properties of woven media:

Heat stabilization or setting (10) - Synthetic filter cloths such as nylon and terylene are heat set by passing them between hot rollers to ensure dimensional stability when used at elevated temperatures. This process reduces the porosity of the fabric by allowing the material to shrink freely, but it may also cause weakening of the fabric.

Water shrinkage - Because many fabrics shrink during use, they are often preshrunk by dipping in boiling water a number of times.

Rot-proofing and special treatments - Special methods are employed to reduce the effect of mould and bacteria on cotton and woollen fabrics. Synthetic fabrics are usually immune to these phenomena.

Special treatment may also be applied to improve cake removal, cloth cleaning and to reduce blinding. Sectional treatment of cloths is carried out in certain circumstances, e.g., local cementing of yarns in areas that are exposed to fraying.

Napping or raising - Napping is carried out using a fine steel comb which produces a soft fuzz on the face of the cloth. This can be useful to improve clarity of the filtrate. The degree of napping can be controlled to give the correct nap for any application.

Calendering - This treatment, which is carried out by passing the cloth between high pressure rollers, gives a smooth polish to the fabric surface which results in better cake discharge.

b) Metallic (4,6)

Metallic filter media have greater strength than the natural or synthetic fabrics, are durable and inert to physical changes, and may be fabricated from a wide variety of extrusive metals such as bronze, copper, lead, Monel, nickel, silver, stainless steel, special alloys, etc.

Metallic media are constructed in the form of screens, wire windings, or woven fabrics (often termed filter cloths because the

methods of fabrication are similar to those of cloths).

Wire screen - Wire screens are used for coarse separations or for supporting filter cloths or filter aids. They are manufactured to standard specifications in terms of mesh sizes and wire diameters and are generally available with square, rectangular or oblong openings. Wire screens are rugged in construction and are easily cleaned.

Wire windings - This type of medium may be made by winding a wire of definite diameter into a filter element threaded to a definite pitch thus producing the desired openings between the windings.

Wire cloth - Wire cloth is versatile and wear-resistant. It is produced in a variety of mesh sizes and weaves from a wide range of wire diameters and materials, each with its own flow characteristics and particle retentivity. Extreme durability is afforded, as shrinkage and stretching are non-existent (6), and a good surface for the formation of cake is provided. This type of cloth, moreover, offers high resistance to blinding and is easily cleaned. The disadvantage of higher cost may be considered to be outweighed by virtue of its very wide application.

Wire cloths are generally available in five standardized basic weave patterns:

1. Plain weave - fabricated from single wires woven at right angles to each other to provide either square or rectangular openings. The strength of this weave is seriously affected when fine diameter wires are used.
2. Twill weave - stronger than the plain weave, but has the disadvantage of restriction in the diameter of the wire used; as the wire diameter increases, the number of openings and consequently the resultant open area is reduced.
3. Stranded or basket weave - twilled weave, but woven of multiple wires instead of a single wire, resulting in a strong dense fabric with a smooth surface.
4. Plain Dutch weave - unlike the previous three, openings are not straight through, but are roughly triangular in shape and twist through the cloth at an angle. Because of this, both the size of openings and percentage of open area are difficult to estimate. This

weave has a firm compact construction which provides relatively small openings and high strength, and is usually calendered to provide a smoother surface.

5. Twill Dutch weave - similar to the plain Dutch weave but gives maximum density and a relatively smooth surface. It can be made of multiple wires in which case it is the strongest and densest of all weaves.

c) Combination of non-metallic and metallic media

Asbestos is sometimes used in combination with woven metallic wires to give the threads greater mechanical strength. The major problem in manufacturing is maintaining uniformity between the metallic wires and the asbestos.

2. Non-woven Flexible Media

The following applies to both preformed and non-preformed media which may include felt, paper, sheets, mats, asbestos, etc., and which in their primitive forms, are considered among the earliest types of media.

Essentially, the medium consists of a large number of fibres arranged at random and these may or may not be bonded. The mechanical and physical properties of the medium depend on the properties of both the fibres and the binder, while the flow properties are mainly dependent on the way the fibres are arranged and on the thickness of the medium. Such a medium usually has a fibrous surface but a smooth surface may be obtained with special treatment.

Many fibrous materials can be used to form this type of media including naturally-occurring or synthetic fibres, e.g., cotton, wool, nylon, etc. and artificially-produced fibres from glass, molten basic furnace slag, etc. Asbestos may also be used and is sometimes mixed with diatomaceous earth with cellulose as a binder. The mineral nature of asbestos and the fact that it contains more mineral impurities leads to the possibility of these impurities dissolving under certain circumstances.

SELECTION OF FILTER MEDIA

Selection of a filter medium is a problem encountered frequently

because of increased demand for optimum operation in filtration processes. The variety in types of filtration equipment and filter media which are available today makes selection even more complex.

To make a satisfactory selection, the following data must be known:

1. Which of the products (filtrate, cake) is to be discarded or retained;
2. Character of the solids: particle size, size range, shape and specific gravity;
3. Character of the fluid: pH, temperature, viscosity, specific gravity, etc;
4. Nature of the slurry: percentage of solids, flocculation, viscosity;
5. Character of the formed cake: rate of build-up, compressibility, resistance to fluid flow, and whether clean, crystalline and friable, plastic, sticky, or slimy;
6. Quantity of material to be handled: to assist in predicting the nature of the activating force (gravity, vacuum, pressure, centrifugal) and the filter medium area;
7. Type of machine used: gravity, pressure, vacuum, drum, disc, plate and frame, etc.

Given this data, it should be possible to determine a number of the following characteristics of the medium:

- (a) Tensile strength;
- (b) Abrasion resistance;
- (c) Resistance to failure caused by flexing;
- (d) Ability to conform to the shape of the unit (6);
- (e) Nature of the weave.

It is important to realize however, that selection of the optimum filter medium is a compromise of the following desirable characteristics: maximum service life; maximum solids recovery; maximum cake release; maximum permeability of flow; maximum production rate; best clarity of filtrate; maximum gasketing; maximum resistance to blinding.

An extremely valuable guide to the practical selection of filter

cloths was given by Ehlers (5) who presented tables to enable the influence of all the factors to be readily appreciated. The guide is based upon five selection factors which are presented in Tables 1 to 5. Additional information based on Dickey (4) and French (6) is given in Table 6.

LITERATURE REFERENCES

- (1) Carman, P.C. "Fundamental principles of industrial filtration"; Trans. Inst. Chem. Eng., Lond.; v. 16, pp 168-188; 1938.
- (2) Cunningham, G.E., Broughton, G. and Krayhill, R.R. "Flow through textile filter media"; Ind. Eng. Chem.; v. 46, no. 6, pp 1196-1200; 1954.
- (3) Coulson, J.M. and Richardson, J.F. "Chemical engineering - unit operations"; v. 2; Pergamon; 1959.
- (4) Dickey, G.D. "Filtration"; Chem. Engineering Series; Reinhold, New York, N.Y.; 1961.
- (5) Ehlers, S. "Evaluation of filter media performance"; Ind. Eng. Chem.; v. 53, pp 869-72; 1961.
- (6) French, R.C. "Filter media", Chem. Eng.; v. 70, no. 21, pp 177-92; 1963.
- (7) Smith, E.G. "Fabric filter media"; Chem. Eng. Progress; v. 47, pp 545-9; 1951.
- (8) Purchas, D.B. "Filtration in chemical and process industries"; Filtration Separation; v. 1, no. 5, pp 256-63; 1964.
- (9) Purchas, D.B. "Filter media - survey"; Filtration Separation; v. 2, no. 6, pp 465-74; 1965.

TABLE 2

First Selection Factor: Chemical and Physical Properties of Fibres
(in Descending Order of Suitability)

Code No.	Material	Resistance to				Tensile Strength	Specific Gravity	Water Absorbency	Resistance to Abrasion and Flexing
		Acids	Alkalies	Heat	Organic Solvents				
1	Nylon	13	13	14	14	14	14	9	1
2	Vinyon*	7	1	13	13	1	13	10	2
3	Saran**	6	7	6	6	5	3	12	3
4	Modacrylic	4	3	12	5	12	12	11	4
5	Polyester	3	2	1	1	7	10	1	5
6	Acrylic	5	4	8	12	4	4	8	6
7	Olefin	2	14	5	10	6	2	6	7
8	Nytril***	8	12	11	9	10	5	5	8
9	Wool	14	10	10	4	8	11	4	9
10	Rayon	9	8	9	2	3	9	2	10
11	Acetate	1	5	7	3	13	8	3	11
12	Cotton	12	6	4	8	11	6	7	12
13	Fluoro-carbon	11	11	3	7	9	1	13	13
14	Glass	10	9	2	11	2	7	14	14

* Trade name for copoly vinyl acetate, copoly vinyl chloride and copoly acrylonitrile manufactured by Carbide and Carbon Chemical Corp.

** Trade name for copoly vinylidene chloride manufactured by Dow Chemical Co.

*** Generic name for fibre containing $\geq 85\%$ polyvinylidene dinitrile.

TABLE 3

Second Selection Factor: Properties of Different Types of Yarn
(in Descending Order of Suitability)

Max Production	Min Cake Moist.	Max Cake Discharge	Max Life	Min Blinding	Max Retention
M	M	M	S	M	S
F	F	F	F	F	F
S	S	S	M	S	M

S Spun-staple

F Multifilament

M Monofilament

TABLE 4

Third Selection Factor: Fabric Geometry
(in Descending Order of Suitability)

Variable	Max Production	Min Cake Moist.	Max Cake Discharge	Max Life	Min Blinding	Max Retention
Yarn Size	S	S	S	L	S	L
	M	M	M	M	M	M
	L	L	L	S	L	S
Twist per inch	H	H	H	M	H	W
	M	M	M	W	M	M
	W	W	W	H	W	H
Threads per inch	W	W	H	M	W	H
	M	M	M	H	M	M
	H	H	W	W	H	W

S = Small M = Medium L = Large

W = Low H = High

TABLE 5

Fourth Selection Factor: Properties of Weave Pattern
(in Descending Order of Suitability)

Max Production	Min Cake Moisture	Max Cake Discharge	Max Life	Min Blinding	Max Retention
S	S	S	T	S	P
T	T	T	P	T	T
P	P	P	S	P	S

P = Plain

T = Twill/chain

S = Satin

TABLE 6

Fifth Selection Factor: Relative Original Cost
of Fibre and Fabric Construction
 (Details in Descending Order of Cost)

<u>Fibre*</u>	Fluorocarbon Acrylic Polyester Wool Nylon Modacrylic Vinyon Saran Olefin Acetate Rayon Glass Cotton
<u>Fibre form</u>	Monofilament Multifilament Spun-staple
<u>Threads per inch</u>	High Medium Low
<u>Twists per inch</u>	High Medium Low
<u>Yarn Size</u>	Large Medium Small
<u>Weave</u>	Satin Twill Plain

* Nitril not included because cost unknown.

TABLE 7

Additional Selection Factors
(To be considered whenever applicable)

Fibres	Tensile Strength	Max Temp (°C)	Appl'n Frequency (%)	Price Ratio (Cotton Basis)	Water Absorb-ency* (%)	Wet Strength (% of dry)	Wet Breaking Tenacity**	Extension at Break (%)	Yarn Forms***
Cotton	High	150	54	1.0	8.5 ¹⁾	120	3.3-6.4	3-10	S
Wool	Low	150	<1	3.7	4.0 ¹⁾	75-95	.76-1.6	20-50	S
Dacron	High	180	2	2.7	-	-	6.0-8.2	-	F-S
Dynel	Fair	93	5	3.2	0.5 ²⁾	100	3.0	31	S
Glass	High	400	7	6.0	-	-	3.0-4.6	-	S
Glass	High	290	7	2.2	-	-	3.9-4.7	-	F
Nylon	High	150	9	2.5	2-4 ²⁾	85-90	2.1-8.0	15-30	F-S-M
Orlon	High	135	2	2.7	1-2 ²⁾	95	1.8-2.1	15-34	S
Saran	High	120	<1	2.5	-	-	1.2-2.3	-	F-M
Teflon	Fair	-	<1	25.0	-	-	1.9	-	F-M
Terylene	-	-	-	-	0.9 ³⁾	100	-	22-30	-
Polyvinyl	-	75	<1	2.7	-	100	1-3	20-35	F
Polyethylene	-	75	<1	2.0	-	-	1-3	-	M
Polypropylene	-	80	-	1.75	-	-	3.5-8.0	-	F-S-M
Rayon & Acetate	-	100	20	1.0	-	-	1.9-3.9	-	F-S

*1) with swelling 2) with slight swelling 3) with no swelling

** Breaking Tenacity = the tensile strength at rupture, grams per denier

*** F Multifilament S Spun-staple M Monofilament

CANMET REPORTS

Recent CANMET reports presently available or soon to be released through Printing and Publishing, Supply and Services, Canada (addresses on inside front cover), or from CANMET Publications Office, 555 Booth Street, Ottawa, Ontario, K1A 0G1:

Les récents rapports de CANMET, qui sont présentement disponibles ou qui ce seront bientôt, peuvent être obtenus de la direction de l'Imprimerie et de l'Édition, Approvisionnements et Services, Canada (adresses au verso de la page couverture), ou du Bureau de Vente et distribution de CANMET, 555 rue Booth, Ottawa, Ontario, K1A 0G1:

- 77-8 Index of commercial flocculants - 1977; H.A. Hamza and J.L. Picard;
Cat. No. M38-13/77-8, ISBN 0-660-01152-2; Price: \$1.00 Canada, \$1.20 other countries.
- 77-14 Pit slope manual - Chapter 7 - Perimeter blasting; P. Calder;
Cat. No. M38-14/7-1977, ISBN 0-660-01011-9; Price: \$2.25 Canada, \$2.70 other countries.
- 77-20 A pilot plant investigation of thermal hydrocracking of Athabasca bitumen - Effect of recycle of heavy oil on product quality; C.P. Khulbe, B.B. Pruden, J.M. Denis and W.H. Merrill;
Cat. No. M38-13/77-20, ISBN 0-660-0098; Price: \$1.50 Canada, \$1.80 other countries.
- 77-21 An apparatus for measurement of thermal diffusivity in air; V.V. Mirkovich;
Cat. No. M38-13/77-21, ISBN 0-662-00746-8; Price: \$1.25 Canada, \$1.50 other countries.
- 77-25 Pit slope manual - Supplement 3-1 - Laboratory classification tests; M. Gyenge;
Cat. No. M38-14/3-1977-1, ISBN 0-660-00995-1; Price: \$1.25 Canada, \$1.50 other countries.
- 77-26 Pit slope manual - Supplement 3-2 - Laboratory tests for design parameters; M. Gyenge and G. Herget;
Cat. No. M38-14/3-1977-2, ISBN 0-660-00996-X; Price: \$1.50 Canada, \$1.80 other countries.
- 77-27 Pit slope manual - Supplement 3-3 - In situ field tests; M. Gyenge and B. Ladanyi;
Cat. No. M38-14/3-1977-3, ISBN 0-660-00997-8; Price: \$1.25 Canada, \$1.50 other countries.
- 77-28 Pit slope manual - Supplement 3-4 - Selected soil tests; M. Gyenge, B. Ladanyi;
Cat. No. M38-14/3-1977-4, ISBN 0-660-0098-6; Price: \$1.50 Canada, \$1.80 other countries.
- 77-29 Pit slope manual - Supplement 3-5 - Sampling and specimen preparation; M. Gyenge and B. Ladanyi;
Cat. No. M38-14/3-1977-5, ISBN 0-660-00999-4; Price: \$1.50 Canada, \$1.80 other countries.
- 77-32 Pilot plant thermal hydrocracking of GCOS (Great Canadian Oil Sands) bitumen. 3. Effect of heavy oil recycle on reactor fouling; C.P. Khulbe, B.B. Pruden, J.M. Denis and W.H. Merrill;
Cat. No. M38-13/77-32, ISBN 0-660-0069-1; Price: \$1.00 Canada, \$1.20 other countries.
- 77-34 X-ray fluorescence on-line analysis of lead-zinc ore fractions in mineral slurries; A comparative study between wavelength-dispersive and energy-dispersive techniques; S.K. Kawatra and J.L. Dalton;
Cat. No. M38-13/77-34, ISBN 0-660-01151-4; Price: \$1.00 Canada, \$1.20 other countries.
- 77-35 Hydrocracking of Athabasca bitumen: Effect of coal-base catalyst on pilot plant operation; C.P. Khulbe, B.B. Pruden and J.M. Denis;
Cat. No. M38-13/77-35, ISBN 0-660-01081-X; Price: \$1.00 Canada, \$1.20 other countries.
- 77-37 Evaluation of a two-stage thermal and catalytic hydrocracking process for Athabasca bitumen; R. Ranganathan, B.B. Pruden, M. Ternan and J.M. Denis;
Cat. No. M38-13/77-37, ISBN 0-660-01157-3; Price: \$1.00 Canada, \$1.20 other countries.
- 77-43 A review of some chemical aspects of the formation of coke during thermal hydrocracking of bitumen; K. Belinko and J.M. Denis;
Cat. No. M38-13/77-43, ISBN 0-660-01158-1; Price: \$1.00 Canada, \$1.20 other countries.