



CANADA



THE EFFECT OF TEST BAR
VARIABLES ON THE MECHANICAL
PROPERTIES OF MAGNESIUM
CASTING ALLOYS

A. COUTURE & J. W. MEIER

DEPARTMENT OF MINES AND
TECHNICAL SURVEYS, OTTAWA

PHYSICAL METALLURGY DIVISION

MINES BRANCH

RESEARCH REPORT

R 151

Price 75 cents

FEBRUARY 1965

Mines Branch Research Report R 151

THE EFFECT OF TEST BAR VARIABLES ON THE MECHANICAL
PROPERTIES OF MAGNESIUM CASTING ALLOYS

by

A. Couture* and J. W. Meier**

ABSTRACT

The effect of machining on the tensile properties of magnesium alloy test bars was investigated. Although some of the differences in property values were found to be statistically significant, they were of the same order as differences that are observed between melts of the same composition. The results showed that the mechanical properties obtained from substandard test bars may be significantly different from those obtained on standard test bars.

The study showed that results obtained on round test bars were significantly higher than those obtained on flat test bars cut from the same parts of the castings.

A comparison of 0.1% and 0.2% yield strength values, obtained on test bars of various magnesium alloys, showed that the linear relationship between these two values is different for most of the alloys and tempers investigated.

Similarly, linear relationships between the elongation values used in North America (4D), in Great Britain (3.5D) and in Continental Europe (5D) were found for the alloys investigated.

* Senior Scientific Officer, Non-Ferrous Metals Section, and ** Principal Metallurgist (Non-Ferrous Metals), Physical Metallurgy Division, Mines Branch, Department of Mines and Technical Surveys, Ottawa, Canada.

Direction des mines

Rapport de recherches R 151

EFFET DE CERTAINES VARIABLES SUR LES PROPRIÉTÉS
MÉCANIQUES D'ÉPROUVETTES EN ALLIAGES
DE MAGNÉSIUM DE FONDERIE

par

A. Couture* et J. W. Meier**

RÉSUMÉ

Les auteurs ont étudié l'effet de l'usinage sur les propriétés mécaniques d'éprouvettes en alliages de magnésium. L'analyse statistique a démontré que l'usinage peut provoquer des variations appréciables de la résistance à la rupture et de l'allongement dans certains cas, mais que ces différences sont du même ordre de grandeur que celles que l'on remarque entre différentes coulées du même alliage. Les résultats montrent que les valeurs obtenues à partir d'éprouvettes de taille réduite peuvent différer grandement de celles obtenues à partir d'éprouvettes de taille normale.

Cette étude a montré que les éprouvettes cylindriques donnent des résultats plus élevés que les éprouvettes rectangulaires alors que les deux proviennent de pièces identiques.

Les auteurs ont établi que la relation entre les limites conventionnelles d'élasticité pour des déformations permanentes de 0.1 et 0.2 p. 100 est linéaire, mais que la droite de correspondance reliant ces deux valeurs peut varier considérablement d'un alliage à l'autre et même d'un état à l'autre.

De même ils ont déterminé des droites de correspondance entre allongements mesurés sur des distances entre repères égales à 4, 3.5 et 5 fois le diamètre de l'éprouvette, distances utilisées en Amérique du Nord, en Grande-Bretagne et sur le Continent européen.

*Agent scientifique senior, Section des métaux non ferreux, et **métallurgiste principal (métaux non ferreux); Division de la métallurgie physique, Direction des mines, ministère des Mines et des Relevés techniques, Ottawa, Canada.

Mines Branch Research Report R 151

THE EFFECT OF TEST BAR VARIABLES ON THE MECHANICAL
PROPERTIES OF MAGNESIUM CASTING ALLOYS

by

A. Couture* and J. W. Meier**

ABSTRACT

The effect of machining on the tensile properties of magnesium alloy test bars was investigated. Although some of the differences in property values were found to be statistically significant, they were of the same order as differences that are observed between melts of the same composition. The results showed that the mechanical properties obtained from substandard test bars may be significantly different from those obtained on standard test bars.

The study showed that results obtained on round test bars were significantly higher than those obtained on flat test bars cut from the same parts of the castings.

A comparison of 0.1% and 0.2% yield strength values, obtained on test bars of various magnesium alloys, showed that the linear relationship between these two values is different for most of the alloys and tempers investigated.

Similarly, linear relationships between the elongation values used in North America (4D), in Great Britain (3.5D) and in Continental Europe (5D) were found for the alloys investigated.

* Senior Scientific Officer, Non-Ferrous Metals Section, and ** Principal Metallurgist (Non-Ferrous Metals), Physical Metallurgy Division, Mines Branch, Department of Mines and Technical Surveys, Ottawa, Canada.

Direction des mines

Rapport de recherches R 151

EFFET DE CERTAINES VARIABLES SUR LES PROPRIÉTÉS
MÉCANIQUES D'ÉPROUVETTES EN ALLIAGES
DE MAGNÉSIUM DE FONDERIE

par

A. Couture* et J. W. Meier**

RÉSUMÉ

Les auteurs ont étudié l'effet de l'usinage sur les propriétés mécaniques d'éprouvettes en alliages de magnésium. L'analyse statistique a démontré que l'usinage peut provoquer des variations appréciables de la résistance à la rupture et de l'allongement dans certains cas, mais que ces différences sont du même ordre de grandeur que celles que l'on remarque entre différentes coulées du même alliage. Les résultats montrent que les valeurs obtenues à partir d'éprouvettes de taille réduite peuvent différer grandement de celles obtenues à partir d'éprouvettes de taille normale.

Cette étude a montré que les éprouvettes cylindriques donnent des résultats plus élevés que les éprouvettes rectangulaires alors que les deux proviennent de pièces identiques.

Les auteurs ont établi que la relation entre les limites conventionnelles d'élasticité pour des déformations permanentes de 0.1 et 0.2 p. 100 est linéaire, mais que la droite de correspondance reliant ces deux valeurs peut varier considérablement d'un alliage à l'autre et même d'un état à l'autre.

De même ils ont déterminé des droites de correspondance entre allongements mesurés sur des distances entre repères égales à 4, 3.5 et 5 fois le diamètre de l'éprouvette, distances utilisées en Amérique du Nord, en Grande-Bretagne et sur le Continent européen.

*Agent scientifique senior, Section des métaux non ferreux, et **métallurgiste principal (métaux non ferreux); Division de la métallurgie physique, Direction des mines, ministère des Mines et des Relevés techniques, Ottawa, Canada.

FIGURES

<u>No.</u>		<u>Page</u>
1.	Test bar design according to Canadian Standard CSA.HG.1.-1963 (U.S.Federal Specification QQ-M-56)	28
2.	Effect of machining on tensile properties of separately- cast test bars (magnesium alloys AZ80 and AZ91) ..	29
3.	Effect of machining on tensile properties of separately- cast test bars (magnesium alloys ZK61 and EZ33) ..	30
4.	Section through reduced part of ZK61 test bar	31
5.	Cross-section through reduced part of ZK61 test bar	32
6.	Same field as in Figure 5, after repolishing. Unetched ..	32
7.	Comparison of 0.1% and 0.2% yield strength values (magnesium casting alloys AZ80-F and AZ91-F) ..	33
8.	Comparison of 0.1% and 0.2% yield strength values (magnesium casting alloy AZ80 in T4 and T6 conditions)	34
9.	Comparison of 0.1% and 0.2% yield strength values (magnesium casting alloy AZ91 in T4 and T6 conditions)	35
10.	Comparison of 0.1% and 0.2% yield strength values (magnesium casting alloy EZ33 in F and T5 conditions)	36
11.	Comparison of 0.1% and 0.2% yield strength values (magnesium casting alloys ZH62-F and ZK61-F) ..	37
12.	Comparison of 0.1% and 0.2% yield strength values (magnesium casting alloys ZK61-T6 and ZH62-T5) ..	38
13.	Comparison of elongation values measured on various gauge lengths (magnesium alloys)	39
14.	Comparison of elongation values measured on various gauge lengths (magnesium alloys AZ92-T6, EZ33-T5 and ZK61-T6)	40

INTRODUCTION

Melt quality and the effects of heat treatment are assessed, throughout the foundry industry, on separately-cast test bars. It is well known that properties obtained on separately-cast test bars do not represent the properties of production castings of various shapes and sizes.

The full value of melt quality evaluation can be achieved only if the test bars are cast and tested under standardized and strictly controlled conditions. As reported earlier^(1,2), there are almost fifty variables that may affect the data obtained from mechanical tests on cast test bars; and these relate to the alloy composition, melting conditions, casting design, heat treatment, test bar preparation, and some testing variables.

This report deals only with some aspects of such variables, namely the effect of test bar preparation, including machining and test bar shape, on the tensile property values, and comparisons of yield strengths and elongations used in various countries.

One of the more serious difficulties in the international use of test bars is the preparation of test bars. Most European countries still specify test bars machined to finished dimensions, whereas North American specifications have, for many years, called for cast-to-shape test bars. There is no doubt that tensile test results depend on the accuracy of dimensional measurements of gauge length cross-section, and that test results may be affected by the cross-section uniformity and the degree of surface smoothness. Nevertheless, it is known, from long-established and general use of cast-to-shape test bars in North American light alloy foundries, that the slight differences in tensile test results are not significant enough to justify costly and time-consuming machining, especially where large numbers of routine tests are made.

The use of standard-size round test bars in testing the properties of castings is often impossible because of the geometrical configuration of the casting (or too small wall thickness). It was, therefore, considered desirable to compare the tensile properties obtained on round and flat test bars cut out of the same locations of cast plates.

Another point of difference in international usage is the determination of yield strength. In Great Britain, the yield strength (or proof stress, as it is called there) is defined as a stress which produces, while the load is still applied, an extension equal to 0.1% of the gauge length. All other countries use a 0.2% yield strength.

A similar situation exists in the use of different gauge lengths in the determination of elongation values. In North America a gauge length equal to 4 times the gauge diameter (4D) is used, while Great Britain uses 3.5D, France 7.25D, and all other European countries 5D or 10D. International standardization requires agreement in convention, which would also greatly assist research workers who have to compare their results with those of their foreign colleagues.

The present report is divided into four separate parts: the first deals with the effect of machining, and to some extent test bar size, on the mechanical property values obtained on separately-cast test bars; the second compares tensile test results obtained on round and on flat test bars cut out of the same locations of cast plates; the third correlates 0.1% and 0.2% yield strength values; and the fourth compares elongation values obtained on gauge lengths equal to 3.5, 4 and 5 times the gauge diameter.

MATERIALS AND ALLOY PREPARATION.

The composition limits specified for the magnesium alloys studied in various parts of this investigation are listed in Table 1. All these alloys were prepared in steel crucibles.

Alloys AZ80, AZ91 and AZ92 were prepared from commercial alloy ingots and melted under a cover of "Domal" crucible flux. After a grain refining with lampblack, the alloys were degassed for 10 min with chlorine and cast into green sand moulds from a temperature of 730 °C (1345 °F).

Alloys EZ33, ZH62 and ZK61 were prepared from pure metals. Magnesium was melted and, when the temperature reached 760 °C (1400 °F), a mixture of 50% $ZrCl_4$, 25% NaCl and 25% KCl was stirred into the magnesium. In all cases zinc was added at this stage. This was followed, in the case of EZ33 alloy, by the addition of Dow 220 flux and the introduction of mischmetal, and, in the case of ZH62 alloy, by the addition of thorium pellets after raising the bath temperature to 800 °C (1470 °F). After the alloying of mischmetal in EZ33, of thorium in ZH62, and of zinc in ZK61, the melts were allowed to settle for 10 min and poured into green sand moulds from a temperature of 760 °C (1400 °F).

Table 2 presents all the temper conditions in which these alloys were tested in some part or parts of the following investigation. The last three columns of the table give the minimum tensile properties specified for separately-cast test bars.

PART I: EFFECT OF MACHINING

Survey of Literature

There is still some controversy on the merits of using cast-to-shape or machined test bars. Some of the literature references have already been discussed in an earlier report⁽³⁾.

Reininger and Mueller⁽⁴⁾ studied the effect of surface smoothness of sand-cast magnesium alloy test bars on the tensile properties and found that bars with polished gauge lengths showed 25% higher UTS and 100% higher elongation values than did bars with gauge lengths treated only with sand paper.

Busk and Phillips⁽⁵⁾ showed that machining test bars of constant grain size to various diameters had no significant effect on the tensile properties of AZ92-T6 alloy.

Busk and Anderson⁽⁶⁾ compared tensile properties of as-cast and machined Mg-Al-Zn alloy test bars and stated that machining raises the tensile strength values from 5 to 10%.

Holm and Krynitsky⁽⁷⁾ found that cast-to-shape AZ63 alloy bars had higher UTS than machined bars, by up to 3,000 psi. They stated that this difference is probably due to the presence of a fine-grained surface layer or skin that is removed in the preparation of the machined specimens.

Flanigan et al.⁽⁸⁾ used, in their investigation, both cast-to-shape and machined test bars and claimed that machined test bars showed an average UTS about 5 to 10% higher than did unmachined bars. It should be noted that the machining was done prior to heat treatment.

Slachta and Mansfield⁽⁹⁾ used EZ33-T5 alloy bars as-cast and after machining, and found that the machined test bars had a slightly higher UTS, but that no conclusions could be drawn for 0.2% YS and elongation.

Experimental Procedure

All test bars were cast in a four-test bar mould according to Canadian Standard CSA.HG.1.5-1963 (similar to U.S. Federal Specification QQ-M-56, Figure 1A), as shown in Figure 1. The chemical compositions of samples drilled from the shoulder part of the test bars taken at random from each melt are given in Table 3 and are within the specified limits (Table 1).

Four AZ80 melts were tested in the "F" and "T6" conditions, three AZ80 melts in the "T4" condition, four AZ91 melts in the "F" and "T6" conditions, three ZK61 melts in the "F" and "T6" conditions, and one EZ23 melt was tested in the "F" and "T5" conditions. (A description of these various temper conditions is given in Table 2.)

For each temper condition, twelve cast-to-shape test bars were taken at random from each melt. Two test bars were left unmachined, while the remaining ten specimens were divided into five groups of two bars each and the gauge lengths were machined to the following diameters: 0.490 to 0.450 (the reduced portion of cast-to-shape test bars was only skinned), 0.438, 0.375, 0.312 and 0.250 in. All machined bars were 5-1/2 in. long and had a 2-1/2-in. long reduced section. The elongation was measured on a length equal to 4 times the diameter of the reduced section. Test bars that had a defective fracture were replaced whenever spare bars were available.

Results

Average tensile test results are presented in Table 4 and in Figures 2 and 3; these values are averages of eight tests for AZ80-F, AZ91-F, AZ80-T6 and AZ91-T6, of six tests for AZ80-T4, ZK61-F and ZK61-T6, and of two tests for EZ33-F and EZ33-T5 alloys.

All tensile test results obtained in this investigation were analysed statistically. The criterion used to assess the significance of an effect was 5%, i.e., when an effect was so large that the probability of its occurring by chance alone was less than 5%, that effect was said to be significant. Where the interaction between melts and machining levels was significant, i.e., where the results obtained for various degrees of machining varied from melt to melt, the data from each melt were analysed separately, because it was feared that the interaction might have masked the effect of machining. In cases where machining had a significant effect on tensile properties, the Multiple Range Test was used to determine which machining levels produced results that were significantly different from the others.

Ultimate Tensile Strength -

Machining had a significant influence on the ultimate tensile strength of AZ80-F, AZ91-T6 and ZK61-T6. In AZ80-T6 bars the machining effect was significant in two melts out of four, and in AZ91-F bars in one out of four.

Machining the skin off cast-to-shape test bars generally caused a marked decrease in the ultimate strength, the results being generally the lowest of the whole series.

The maximum strength values of machined AZ80-F bars are found in the 0.438 in., 0.375 in. and 0.313 in. bars; these values are the same as those of unmachined bars. In the AZ91-F series and in both the ZK61-F and ZK61-T6 series, all machined bars have lower strength values than the unmachined ones.

The ultimate strength values of some machined bars were higher than those of unmachined bars in the AZ80-T6 and AZ91-T6 series. The machined bars that were stronger than the unmachined ones were 0.375, 0.313 and 0.250 in. in diameter in the AZ80-T6 series, while in AZ91-T6 all machined bars had higher strength values than the unmachined ones. The maximum increase was found, in both cases, in the 0.250 in. bars. It was about 4% in the AZ80-T6 and 9% in the AZ91-T6 bars.

Yield Strength -

Machining had a statistically significant effect on the yield strength of all alloys, with the exception of the EZ33-F series.

The yield strength of AZ80 alloy was significantly increased by machining in all three conditions in which bars were tested. The maximum increases - found in the smallest bars - were 13% in the "F" series, 25% in the "T4" series, and 6% in the "T6" series. In AZ91 alloy the lowest values are found after the first degree of machining. However, additional machining gradually improves the yield strength to approximately the same level as in the unmachined bars. The 0.250 in. bars have the highest yield strength values of the EZ33 series. In EZ33-T5 these are significantly higher than those of unmachined bars; the improvement is 14%. The highest yield strength values for ZK61 alloy are in the unmachined bars.

Elongation -

The elongation was significantly increased by machining in the AZ80-T4, AZ80-T6 and AZ91-T6 series. In AZ80-T4 the maximum values were obtained in the 0.490 in. and 0.375 in. bars. In AZ80-T6 the highest elongation values were obtained with the 0.250 in. bars, while, in the AZ91-T6 series, all machined bars had significantly higher elongation results than the unmachined ones. In the other series, machining had no significant effect.

Special Tests

The following tests were carried out in order to determine whether the hardness, metallographic structure and chemical composition of the alloys studied vary throughout the test bar cross sections. Unfortunately, the results reported below cannot be accurately correlated with tensile test results, as these tests would have to be made in the same bars as those used for the tensile tests for a given machining level and, of course, test bars were destroyed during either one of these tests. However, it was thought that, by using several specimens in each of the following tests, an idea would be obtained of the conditions which existed in test bars used for tensile tests.

(1) Hardness -

Twelve specimens (5 of AZ80, 4 of AZ91, and 3 of ZK61) were cut at right angle to the axis of machined test bars through their reduced sections. Microhardness determinations were made every 0.003 in. from 0.002 to 0.020 in. from the edge and, from that point, every 0.010 in., until the centre of the specimen was reached. It was found that hardness results vary appreciably across the surface, but no definite trend could be established.

(2) Metallographic Examination -

Transverse sections taken through the reduced part of unmachined test bars of AZ80, AZ91 and ZK61 alloys were examined under the microscope in the as-cast (F) and solution-treated-and-aged (T6) conditions. The microstructure of AZ80 and AZ91 alloys appeared to be uniform throughout the sections.

However, most ZK61 specimens show an appreciable variation in grain size across the sections and Figure 4 is representative of that phenomenon. In general, grains are small near the edge of the test bar (upper part of Figure 4), larger at a short distance from the edge, and small again and relatively uniform towards the centre of the specimens (lower part of Figure 4).

At low magnification the coarse-grained band appears lighter than either the edge or the central parts of the section. The light band may appear as in Figure 5, whereas in other specimens the central part of the band is not revealed or the phenomenon is non-existent.

Comparison of Figure 5, taken in the etched condition, with Figure 6, in the unetched condition, indicates that the coarse-grained band corresponds to a band of porosity.

Of course, attempts to explain these phenomena would be beyond the scope of this investigation. However, it appears at first glance that they are somehow related to the flow pattern of the molten metal into the mould. Work is now under way to provide a proper explanation for these anomalies⁽¹⁰⁾.

(3) Spectrographic Analysis -

A spectrographic analysis survey was carried out on six specimens each of AZ80, AZ91 and ZK61 alloys, using a microvolume traverse⁽¹¹⁾ examination of the cross-sections of the test bars.

Although appreciable variations were found across the surface of AZ80 and AZ91 samples, no trend could be established with the exception that the lines showing the aluminum and zinc contents versus distance are essentially parallel.

ZK61 samples were analysed for zinc and zirconium. In two specimens the coarse-grained band was crossed by the transversing spark, and in both cases the band corresponds to a lower zirconium content than the average. Although, in six additional samples which showed a banded structure and were analysed in a similar manner, no relationship could be established between the coarse-grained areas and the zirconium content, preliminary chemical analysis results suggest that the zirconium content is lower in the banded zone than in the centre of the bar⁽¹⁰⁾. This phenomenon is now being investigated and it appears that this band of porous coarser grain material is related to the solidification and flow patterns of the liquid metal in the mould cavity.

Discussion of Results

As mentioned earlier, all the mechanical property values were analysed statistically as an aid to evaluating the significance of trends in the influence of machining on tensile test results. It was found that machining had a significant effect in several cases. The most important trend is seen in comparing results from cast-to-shape test bars with those from bars from which the skin had been machined off; in many cases, the first

machining level produced the lowest results of the whole series. However, the properties generally increased with bars of smaller diameters until the original level of properties of cast-to-shape bars was reached, or even exceeded, as is shown by the ultimate strength values of AZ80-T6 and AZ91-T6 alloys; the increase in these cases was 4 and 9%, respectively.

In other cases where machining had a significant effect, there is no simple relationship between the degree of machining and any of the tensile properties. The differences due to machining are irregular and are generally of the same order of magnitude as the differences between melts of the same alloy even though these melts are within the limits specified for chemical composition. Such variations may be due to small differences in chemical composition or porosity throughout the reduced portion of the test bars.

In these statistical tests, differences due to machining or from melt to melt of the same composition were tested against the residual error, which is a measure of the variation between specimens of the same group and treatment. In other words, the larger the experimental error the larger a given effect has to be in order to be shown as significant; and, vice-versa, the smaller the experimental error the more sensitive the statistical test is. For instance, this is why the test showed that the ultimate strength of cast-to-shape ZK61-F test bars was not significantly reduced by machining with a decrease of 5.1%, whereas in ZK61-T6 test bars a decrease of 3.6% in ultimate strength was significant. However, the analysis of variance for these two groups of specimens indicates that the effect due to machining was of the same order in both cases, but that the residual error against which this effect was tested was twice as large in ZK61-F test bars as in ZK61-T6 bars and, consequently, masked the effect of machining. There are other examples of similar irregularities, and thus, in drawing the graphs presented in Figures 2 and 3, these considerations were taken into account and only serious differences were underlined.

Conclusions

1. Machining the skin off cast-to-shape test bars generally produced the lowest ultimate strength in any series of bars. In the AZ80-T6 and AZ91-T6 series, the strength of the 0.250 in. bars exceeded that of unmachined bars by 4 and 9%, respectively.
2. In AZ80, the yield strength of the smallest bars was significantly higher than that of the other bars. The maximum increase was 13% in the "F" series, 25% in the "T4" series and 6% in the "T6" series, as compared with the results of unmachined bars. In

machined bars there is, in all cases, a tendency towards higher yield strength as the test bar diameter decreases.

3. The elongation was significantly increased by machining in the AZ80-T4, AZ80-T6 and AZ91-T6 series.
4. Hardness results showed that machining did not harden the outside layer of the bars; no definite trend was established.
5. The microstructures of AZ80 and AZ91 are uniform. However, ZK61 alloy specimens showed a banded structure and the grain size varied accordingly. This was accompanied by a band of porosity corresponding to the coarser-grained material.
6. Spectrographic analysis did not reveal any definite segregation trends. However, there is a suggestion that the coarse-grained bands of ZK61 may have a lower zirconium content than the average.
7. This work shows that, within the diameter range and for the alloys studied, the mechanical properties obtained from sub-standard test bars may be significantly different from those that would be obtained from standard test bars, but that the degree of variation and its direction cannot be predicted from the data analysed in this investigation.

PART II: TEST BAR SHAPE

Survey of Literature

In many cases the shape of the test bar cut out of a casting depends on the dimensions of the casting. It was therefore considered desirable to compare properties obtained on round and flat test bars cut out from the same locations of the casting.

Reininger and Mueller⁽⁴⁾ found that, even in completely sound magnesium alloy castings, variations in strength properties depend on the shape of the cross-section of structural parts. Because of a more uniform distribution of stresses, round bars show, in general, higher UTS and elongation than do flat specimens. In comparing values obtained on flat specimens, the elongation decreases as the ratio of specimen width to specimen thickness becomes higher than 3:1. The Mg-Al-Zn alloy test specimens used in this work were all cast from the same melts in test coupons of identical wall thickness and machined to round and various flat bar dimensions. In all cases the round bars showed the highest UTS and elongation values.

Busk and Phillips⁽⁵⁾ compared the tensile properties obtained on various round test bars and a flat bar, which were all machined from cast bars of the same size. The flat bar showed slightly lower properties than the round bars.

Johnson and Bishop⁽¹²⁾ investigated aluminum alloys and found that flat specimens exhibit lower tensile strength than do round bars machined from the same location of cast plates.

Preliminary Investigation

In the preliminary stage of this investigation, 3/16 and 1/4 in. plates and cast-to-shape test bars (Figure 1) were cast in green sand from two AZ91 alloy (Table 1) melts. The plates were 4-1/2 in. wide and 6 in. long and were risered at one end. The chemical analysis of the melts is given in the upper part of Table 5. The plates were split longitudinally into four slices, one melt being machined in the as-cast (F) condition and the other in the solution-treated-and-aged (T6) condition as described in Table 2. These slices were machined into round test bars with a 1/8 in. diameter

and a 1/2 in. long reduced section, and into flat test bars with a 5/32 in. thickness, a 1/2 in. width and a 2-1/2 in. long reduced section. Both the round and flat bars had flat ends.

Average mechanical property results are presented in Table 6. It was found by statistical analysis that round bars gave significantly higher ultimate tensile strength and yield strength results than did flat test bars. The ultimate strength of round bars is higher than that of flat bars, by 9% in the as-cast (F) condition and 6% in the fully heat-treated (T6) condition. For the yield strength these figures are 17 and 20% respectively. On the other hand, the elongation values are practically identical for both sets of bars.

Main Investigation

In order to determine whether the conclusions drawn in the preliminary stage of this investigation could be substantiated, the following experiment was carried out: Magnesium alloys AZ80 and AZ91 were melted and prepared as described earlier and sand-cast in 1/4, 3/8 and 1/2 in. plates. The width of the plates was 4-1/2 in. and their length 6 in. Plates were risered at one end only.

The chemical compositions of the melts used in the various temper conditions are given in the lower part of Table 5, and the temper conditions are described in Table 2. Two plates of each thickness were used for each temper condition and test coupons were so cut that the long axis of the test bar would be in the longitudinal direction of the plates. From each plate two round test bars and two flat test bars were taken in random positions in order to decrease the importance of the position effect. The test bar diameters were 1/8 in. for the 1/4 in. plate, 3/16 in. for the 3/8 in. plates, and 5/16 in. for the 1/2 in. plates. The thicknesses of flat bars were the same as the diameter of the round bars for the corresponding plate thickness, and their width was 1/2 in. The elongation values obtained from flat bars were calculated in a length equal to 4.5 times the square root of the area, which corresponds to a length of 4 diameters for round bars. The required heat treatments were carried out on the unmachined plates.

Mechanical property results for both round and flat test bars are summarized in Table 7. Each result is the average of four tests and all individual results were statistically analysed.

It was found that in the case of the AZ80-F, AZ91-F, AZ91-T4 and AZ91-T6 alloys, the ultimate tensile strength results obtained from round test bars are significantly higher than those from flat test bars. The same conclusion applies to the yield strength of AZ80-F, AZ80-T4 and AZ91-F, and to the elongation of AZ91-T4 and AZ91-T6. In most of these

cases a difference of that order would arise by chance alone in less than one case in 100. As expected, it was found that plate thickness generally has a significant effect on mechanical properties, but this factor will be discussed in a separate report(13).

Discussion

Comparison of the results obtained from AZ91-F and AZ91-T6 test bars in the preliminary (Table 6) and main (Table 7) experiments reveals that, in general, the conclusions drawn from the preliminary experiment also hold for the main experiment. However, the yield strength of AZ91-T6 bars is not affected by the shape in the main experiment, whereas results from round bars are significantly higher than those from flat bars in the preliminary experiment; also, elongation results from AZ91-T6 bars are significantly higher for round bars than for flat bars in the main experiment, whereas the elongation results were the same in the preliminary work. It must be remembered, however, that several differences exist in the testing conditions of these two experiments. In the preliminary stage only 3/16 and 1/4 in. plates were cast, whereas in the main section 1/4, 3/8 and 1/2 in. plates were tested; the bar diameter for the first set of results was 1/8 in., and in the main work the bar diameters were 1/8, 3/16 and 5/16 in. for the 1/4, 3/8 and 1/2 in. plates respectively; and the ends of the round bars, which were flat in the preliminary experiment, were round and threaded in the main study. All these factors may have influenced the results one way or the other and any comparison between the two sets of results is consequently somewhat limited.

In spite of these discrepancies, results from the two experiments generally agree; furthermore, similar tests on AZ80-F, AZ80-T4 and AZ91-T4 alloys generally indicate that round test bars yield higher tensile test values than flat test bars.

It is worthwhile to mention, however, that the limitations of this experiment are fully realized and that the conclusions drawn from this work should not be made too general. It is quite possible that entirely different results would have been obtained if the cross-sectional areas of both round and flat bars had been the same for each round bar diameter used. In order not to complicate this experiment, the flat test bar width was kept constant at 1/2 in., as this is a convenient size to machine and use. Consequently, the ratios of the cross-sectional areas of flat to round bars are 5 for the 1/8 in. bars, 3.5 for the 3/16 in. bars, and 2 for the 5/16 in. bars. The effect of such a difference in cross-sectional areas between round and flat bars and of various area ratios may be significant.

During the statistical analysis of the results reported here, it was also found that the interaction effect between test bar shape and plate thickness was significant in many cases. In other words, the shape effect varied significantly with plate thickness.

Conclusions

The results of this investigation show that the ultimate tensile strength of round test bars is significantly higher than that of flat test bars in the AZ80-F, AZ91-F, AZ91-T4 and AZ91-T6 series; similarly, the yield strength in the AZ80-F, AZ80-T4 and AZ91-F series, and the elongation in the AZ91-T4 and AZ91-T6 series, are higher in the round bars.

Although these conclusions should not be generalized because of the limitations discussed in this study, the user and designer of castings should nevertheless be aware of the differences in tensile test results which may arise from the use of test bars of different shapes.

PART III: YIELD STRENGTH

Background

Yield strength (or proof stress, as it is termed in Great Britain) is the most important design criterion of non-ferrous alloys and it is, therefore, necessary to compare yield strength results determined and reported according to the particular specified permanent set. In order to permit comparison of test results given in British papers and reports with those obtained in North American practice, and to have some data for discussions at ISO/TC79 meetings, an attempt was made to find a relationship between 0.1% and 0.2% yield strength values for twelve magnesium casting alloys (five alloy compositions in various tempers).

Materials and Procedure

The data analysed in this investigation were obtained from Dow test bars (Figure 1) used in the evaluation of the influence of other factors such as casting temperature, holding time, machining, etc., the results of which are reported elsewhere. In those sections, however, only the 0.2% yield strength values were reported, although the 0.1% yield strength values were available.

In view of the large number of melts from which the data presented in this study were drawn, it is practically impossible to present the chemical composition results from each melt. However, the practice in these laboratories is to retain only melts that have a chemical composition within or close to the limits imposed by specifications (Table 1).

The temper conditions in which each alloy was used are described in Table 2, which also gives the minimum yield strength values required.

Results

Figures 7 to 12 present all the individual data studied in the course of this investigation. A grand total of 1665 pairs of data were available, and the number of test bars from each alloy is given in the second column of Table 8.

These data were analysed separately for each alloy by means of statistical methods in order to determine the type of relationship that exists between 0.1 and 0.2% yield strength values and the equation of the curve representing that relationship. In all cases it was found that the relationship existing between 0.1 and 0.2% yield strength values can be adequately represented by a straight line over the range of results investigated. The equations of these straight lines are given in the fifth column of Table 8, and are represented by the solid lines of Figures 7 to 12. Additional statistical tests were carried out in order to determine whether two or more curves could be pooled, i.e., whether the relationship for one alloy was essentially the same as that for another or other alloys. It was found that the relationship differed significantly from alloy to alloy and for different temper conditions, with the exception of AZ80-F and AZ91-F, and ZH62-F and ZK61-F results, which were plotted as single lines in Figures 7 to 11 respectively. The level of significance used in this work was 5%, i.e., when an effect or difference of the magnitude found in these tests would arise by chance alone in less than 5 cases out of 100, such an effect or difference was considered to be significant.

Discussion and Interpretation of Results

Examination of the equations shown in the fifth column of Table 8 indicates that the ratio of 0.2% yield strength to 0.1% yield strength varies with the yield strength level considered. The equations being of the type $y = a + bx$, the ratio y/x is constant only if "a" equals zero. The "a" factor has no physical significance, because the equations obtained are valid only for the ranges of values investigated.

The dotted lines of Figures 7 to 12 are the 95% confidence limits for a single prediction of the 0.1% yield strength from a given 0.2% yield strength value. These limits are given in the last two columns of Table 8 for typical 0.2% yield strength values. The limits are shown as straight lines on Figures 7 to 12, although the confidence bands should be wider at both ends; however, for the range of 0.2% yield strength investigated, the errors so introduced are not measurable on the scale used in these graphs. It may be worthwhile to remind the reader that these limits should not be extrapolated to values not covered by the present tests.

PART IV: ELONGATION

Background

This study was undertaken to compare elongation values based on gauge length equal to four gauge diameters (4D, as used in North America) with those based on a gauge length equal to 4 times the square root of the gauge section area (or 3.5D, as used in Great Britain), and 5 times the gauge diameter (5D, as used in most Continental European countries).

It is known, from numerous papers published in the past 50 years (e.g. (14, 15)), that elongation values can be compared directly only if measured on test specimens having an identical gauge length-to-diameter ratio. Unfortunately, these two ratios are not identical in the above cases.

Procedure

The test bars used in this study were taken from various investigations carried out in these laboratories. Their chemical composition was within the specified limits given in Table 1 and the temper conditions in which they were tested are described in Table 2.

Results

The data presented in this study were statistically analysed in the manner described in Part III of this report. It was found that the relationships between elongation values measured on gauge lengths equal to 3.5, 4 and 5 times the diameter of the reduced section can be adequately represented by straight lines in the cases under investigation. The relationship between 3.5D ($4\sqrt{\text{area}}$) and 4D is shown as a thick line in Figure 13 for a number of magnesium alloys in various temper conditions, the other lines having been drawn at 45° through the origin and the 1 and 2% elongations in 3.5D. Figure 14 gives the straight lines correlating elongation values measured in 5D and 4D for AZ92-T6, EZ33-T5 and ZK61-T6. Again a line was drawn through the origin at 45° in order to indicate the differences between the two measures. The number of tests, the average elongation in 4D and 5D, and the equations of the lines of Figures 13 and 14 are given in Table 9. As in the yield strength study, the intercept values have no physical significance.

REFERENCES

1. J. W. Meier - "The Effect of Various Factors on the Mechanical Properties of Magnesium Alloy Castings" - Proc. 25th International Foundry Congress, Brussels, pp. 223-240 (1958); Mines Branch Research Report R 38 (1958).
2. J. W. Meier and A. Couture - "Effect of Casting Temperature on Aluminum Alloy Test Bar Properties" - Mines Branch Research Report R 54, Department of Mines and Technical Surveys, Ottawa, Canada (1959); Trans. AFS 68, 636-647 (1960).
3. A. Couture and J. W. Meier - "The Effect of Some Test Bar Variables on the Mechanical Properties of Aluminum Alloys" - Mines Branch Research Report R 102, Department of Mines and Technical Surveys, Ottawa, Canada (1962).
4. H. Reininger and J. Mueller - "Variations in Tensile Strength and Elongation of Magnesium Sand Castings, Their Cause and Means of Restricting Them" - Z. Metallkunde 31, 172-182 (1939).
5. R. S. Busk and C. W. Phillips - "Grain Size and Properties of Sand-Cast Magnesium Alloys" - Trans. AIME 161, 266-277 (1945).
6. R. S. Busk and R. E. Anderson - "Water Quenching of Some Typical Magnesium Casting Alloys" - Trans. AIME 161, 278-290 (1945).
7. V. C. Holm and A. I. Krynitsky - "Control of Grain Size in Magnesium Casting Alloys" - Foundry 75(10), 81, 228-240 (Oct. 1947).
8. A. E. Flanigan, I. I. Cornet, R. Hultgren, J. T. Lapsley and J. E. Dorn - "Factors Involved in Heat Treating a Magnesium Alloy" - Trans. AIME 175, 524-563 (1948).
9. A. G. Slachta and H. Mansfield - "The Meaning of the Cast Test Bar in the Evaluation of Aluminum and Magnesium Alloy Castings" - Trans. AFS 63, 223-232 (1955).

10. B. Lagowski - unpublished work.
11. J. Convey and J. H. Oldfield - "A Micro-Spectrographic Method for the Quantitative Analysis of Steel Segregates" - J. Iron and Steel Inst. 152(2), 473-498 (1945).
12. W. H. Johnson and H. F. Bishop - "Effect of Geometry on the Properties of 195-T6 and 356-T6 Aluminum Alloy Castings" - NRL Report 4761, Naval Research Laboratory, Washington, D. C. (1956); also as W. H. Johnson and H. F. Bishop - "Effect of Geometry on the Properties of C4A-T6 and SG70A-T6 Aluminum-Alloy Castings" - Proc. ASTM 56, 724-737 (1956).
13. A. Couture and J. W. Meier - "Properties of Sand-Cast Magnesium Alloys. Part VII: The Effect of Wall Thickness on Tensile Properties of Mg-Al-Zn Alloy Castings" - Mines Branch Research Report R 153, Department of Mines and Technical Surveys, Ottawa, Canada (1965).
14. P. Melchior - "The Effect of the Gauge Length Ratio on the Elongation of Aluminum" - Z. Metallkunde 20, 252-257 (1928); J. Inst. Metals 40, 609 (1928).
15. E. v. Burg - "The Effect of Gauge Length on the Elongation" - Aluminium 20, 786-788 (1938); Met. Abstr. 6, 20 (1939).

===

AC:JWM:(PES):vb

TABLE 1

Chemical Composition of Magnesium Casting Alloys(%)*

Alloy Designation**	Al	Zn	Mn	Zr	R.E.	Th
AZ80	7.5-8.5	0.3-0.7	0.2-0.4	-	-	-
AZ91	8.3-9.3	0.4-1.0	0.2-0.4	-	-	-
AZ92	8.3-9.7	1.6-2.4	0.10 min	-	-	-
EZ33	-	2.0-3.5	-	0.5-1.0	2.5-4.0	-
ZH62	-	5.2-6.2	-	0.5-1.0	-	1.4-2.2
ZK61	-	5.5-6.5	-	0.6-1.0	-	-

* According to Canadian Standard CSA.HG.9-1963.

** According to CSA Code H.1.1.-1958.

TABLE 2

Heat Treatments Used and Properties Specified for Separately-Cast Test Bars*

Alloy Designation**	Solution Treatment			Ageing Treatment			UTS, kpsi	0.2% YS, kpsi	El, % in 2 in.
	Temperature		Time, hr	Temperature		Time, hr			
	°C	°F		°C	°F				
AZ80-F	-	-	-	-	-	-	23	-	3
AZ80-T4	410	770	24	-	-	-	34	-	7
AZ80-T6	410	770	24	190	375	16	34	12	4
AZ91-F	-	-	-	-	-	-	23	12	-
AZ91-T4	410	770	24	-	-	-	34	12	7
AZ91-T6	410	770	24	200	390	16	34	16	3
AZ92-T6	415	780	20	190	375	16	34	18	1
EZ33-F	-	-	-	-	-	-	-	-	-
EZ33-T5	-	-	-	175	345	16	20	13	2
ZH62-F	-	-	-	-	-	-	-	-	-
ZH62-T5	-	-	-	180	355	16	35	22	4
ZK61-F	-	-	-	-	-	-	35	18	8
ZK61-T6	500	930	2	130	265	48	42	26	5

* According to Canadian Standard CSA.HG.9-1963.

** According to CSA Codes H.1.1-1958 and H.1.2-1958.

TABLE 3

Ranges of Analytical Results (%)

Alloy Designation*	Al	Zn	Mn	Zr	R.E.
AZ80	7.91-8.46	0.35-0.45	0.30-0.37	-	-
AZ91	8.80-8.92	0.53-0.66	0.34-0.37	-	-
EZ33**	-	2.75	-	0.61	3.20
ZK61	-	5.95-6.19	-	0.72-0.75	-

* According to CSA Code H.1.1-1958.

** Only one melt was used for EZ33 alloy.

TABLE 4

Effect of Machining on Tensile Properties of
Separately-Cast Test Bars of Some Magnesium Casting Alloys

Alloy ** Designation	Prop- erty	Unmachined 0.505 in.	Machined to (inches)				
			0.490	0.438	0.375	0.312	0.250
AZ80-F	UTS*	28.1	26.5	28.0	28.1	28.1	27.7
	YS*	14.9	15.0	14.9	14.9	16.5	16.8
	E1*	6.0	5.0	6.0	6.0	5.5	6.0
AZ80-T4	UTS	40.5	40.4	39.8	40.2	40.0	40.1
	YS	13.4	14.3	13.7	13.8	14.2	16.7
	E1	16.5	19.0	18.0	19.0	17.0	17.5
AZ80-T6	UTS	40.6	39.8	40.7	41.8	41.4	42.4
	YS	18.7	18.3	18.3	17.7	18.5	19.7
	E1	7.0	7.0	6.0	9.5	9.0	11.0
AZ91-F	UTS	26.4	24.5	25.8	25.4	25.4	25.9
	YS	15.3	14.6	15.4	15.7	16.1	16.1
	E1	4.0	4.5	4.0	3.5	3.5	4.5
AZ91-T6	UTS	39.5	40.0	42.3	42.0	43.0	43.2
	YS	21.0	19.3	20.5	20.6	21.3	21.3
	E1	3.5	5.5	5.5	6.0	6.0	5.5
EZ33-F	UTS	21.7	20.8	21.2	21.3	21.9	21.8
	YS	14.6	13.7	13.4	14.3	14.6	15.3
	E1	4.0	5.0	3.5	4.0	5.0	5.5
EZ33-T5	UTS	21.4	20.8	21.2	21.4	21.2	21.6
	YS	14.8	14.6	14.0	15.1	16.6	16.8
	E1	4.0	4.0	4.0	4.0	4.0	4.0
ZK61-F	UTS	40.5	38.4	38.6	39.3	38.6	39.1
	YS	24.1	22.8	22.5	22.9	23.2	23.4
	E1	10.5	9.0	10.0	10.0	8.5	9.0
ZK61-T6	UTS	47.4	45.7	45.8	45.2	46.1	46.7
	YS	32.4	31.0	30.8	30.5	31.6	32.1
	E1	11.0	12.0	10.0	10.0	10.0	11.0

* UTS - Ultimate Tensile Strength, kpsi; YS - 0.2% Yield Strength, kpsi;
E1 - Elongation % in 4 times the test bar diameter.

** According to CSA Codes H.1.1 - 1958 and H.1.2 - 1958.

TABLE 5

Chemical Composition of Magnesium Alloy Melts
Used to Study the Effect of Test Bar Shape

Alloy Designation*	Al, %	Zn, %	Mn, %
AZ91-F	8.87	0.63	0.35
AZ91-T6	8.99	0.64	0.28
AZ80-F	8.00	0.40	0.24
AZ80-T4	8.42	0.40	0.42
AZ91-F and AZ91-T4	9.20	0.67	0.31
AZ91-T6	9.43	0.71	0.35

* According to Canadian Code CSA. H.1.1- and H.1.2-1958.

TABLE 6

Effect of Test Bar Shape on Tensile Properties of
Sand-Cast AZ91 Alloy Plates

Alloy Designation*	Type of Test Bar	No. of Tests	UTS**	YS**	E1**
AZ91-F	Round***	14	32.1	20.8	4
	Flat***	16	29.5	17.8	5
	Separately-cast	2	26.5	15.0	5
AZ91-T6	Round	12	41.9	26.9	4
	Flat	13	39.7	22.5	5
	Separately-cast	3	40.2	20.7	4.5

* According to Canadian Code CSA. H.1.1 - and H.1.2-1958.

** UTS - Ultimate Tensile Strength, kpsi,

YS - 0.2% Yield Strength, kpsi,

E1 - Elongation, % in 4D for round test bars,

in 2 in. for "as-cast" flat test bars, and

in $4.5\sqrt{\text{area}}$ for heat-treated-and-aged flat test bars.

*** Diameter of reduced section of round bars - 1/8 in.

Thickness of flat bars - 5/32 in.; width 1/2 in.

TABLE 7

Effect of Test Bar Shape on Tensile Properties of
Sand-Cast Magnesium Alloy Plates

Alloy * Designation	Plate Thickness, in.	Round Test Bars			Flat Test Bars		
		UTS**	YS**	EI**	UTS**	YS**	EI**
AZ80-F	1/4	29.6	17.4	5.5	27.4	15.5	5.0
	3/8	28.0	16.6	5.5	26.2	14.6	4.5
	1/2	<u>25.1</u>	<u>14.3</u>	<u>5.0</u>	<u>23.0</u>	<u>14.4</u>	<u>3.0</u>
	Average	<u>27.6</u>	<u>16.1</u>	<u>5.5</u>	<u>25.5</u>	<u>14.9</u>	<u>4.0</u>
	Cast-to-shape bars	27.2	14.9	5.0			
AZ80-T4	1/4	40.9	17.6	20.0	40.4	14.4	18.5
	3/8	40.5	14.9	17.5	40.3	13.6	20.0
	1/2	<u>37.6</u>	<u>12.3</u>	<u>14.5</u>	<u>37.4</u>	<u>12.8</u>	<u>14.0</u>
	Average	<u>39.7</u>	<u>14.9</u>	<u>17.5</u>	<u>39.4</u>	<u>13.6</u>	<u>17.5</u>
	Cast-to-shape bars	40.1	14.0	17.0			
AZ91-F	1/4	29.4	18.9	4.0	27.4	15.9	4.0
	3/8	28.5	17.4	4.5	25.0	16.3	4.0
	1/2	<u>25.6</u>	<u>15.6</u>	<u>4.0</u>	<u>24.0</u>	<u>15.3</u>	<u>3.5</u>
	Average	<u>27.8</u>	<u>17.3</u>	<u>4.0</u>	<u>25.5</u>	<u>15.8</u>	<u>4.0</u>
	Cast-to-shape bars	26.5	16.0	4.5			
AZ91-T4	1/4	41.8	17.9	18.5	40.2	16.8	13.0
	3/8	42.0	16.9	19.5	41.9	15.1	19.5
	1/2	<u>41.7</u>	<u>14.0</u>	<u>18.0</u>	<u>40.6</u>	<u>14.9</u>	<u>14.5</u>
	Average	<u>41.8</u>	<u>16.3</u>	<u>18.5</u>	<u>40.8</u>	<u>15.6</u>	<u>15.5</u>
	Cast-to-shape bars	41.6	14.5	17.0			
AZ91-T6	1/4	48.2	23.8	10.0	41.7	22.3	5.0
	3/8	47.2	21.6	9.0	39.5	23.0	2.5
	1/2	<u>43.4</u>	<u>22.6</u>	<u>4.5</u>	<u>39.6</u>	<u>21.8</u>	<u>3.0</u>
	Average	<u>46.3</u>	<u>22.7</u>	<u>8.0</u>	<u>40.2</u>	<u>22.4</u>	<u>3.5</u>
	Cast-to-shape bars	41.0	23.5	3.5			

* According to Canadian Code CSA.H.1.1 - and H.1.2 - 1958.

** UTS - Ultimate Tensile Strength, kpsi,

YS - 0.2% Yield Strength, kpsi,

EI - Elongation, % in 4D for round bars and in $4.5\sqrt{\text{area}}$ for flat bars.

TABLE 8

Relationship Between 0.1 and 0.2% Yield Strength Values

Alloy * Designation	Number of Specimens	Average		0.1% Yield Strength equals	Typical Yield Strength**, kpsi		
		0.2%	0.1%		Typical 0.2% YS	Limits for 0.1% YS	
						Lower	Upper
AZ80-F	159	14.6	12.2	-0.83 + 0.89 YS 0.2	15	11.6	13.3
AZ80-T4	149	13.4	11.2	2.74 + 0.63 YS 0.2	13	10.3	11.6
AZ80-T6	170	17.8	14.5	2.67 + 0.67 YS 0.2	18	13.9	15.5
AZ91-F	163	15.7	12.9	-0.84 + 0.88 YS 0.2	15	11.6	13.3
AZ91-T4	128	14.1	11.7	0.92 + 0.76 YS 0.2	14	11.0	12.3
AZ91-T6	159	21.5	17.1	2.17 + 0.69 YS 0.2	21	15.9	17.6
EZ33-F	55	15.1	13.3	-0.63 + 0.92 YS 0.2	15	12.4	13.9
EZ33-T5	48	15.8	13.8	1.71 + 0.76 YS 0.2	16	13.2	14.7
ZH62-F	152	21.9	19.5	3.99 + 0.71 YS 0.2	22	18.4	20.8
ZH62-T5	149	26.0	23.2	6.08 + 0.66 YS 0.2	26	21.8	24.5
ZK61-F	164	22.7	20.1	3.76 + 0.72 YS 0.2	23	19.1	21.5
ZK61-T6	169	31.7	28.3	1.95 + 0.83 YS 0.2	32	27.0	30.1

* According to CSA Codes H.1.1 - 1958 and H.1.2 - 1958:

** According to results obtained in the Laboratories of the Physical Metallurgy Division, Mines Branch, Department of Mines and Technical Surveys, Ottawa, Canada.

TABLE 9

Relationship Between Elongation Values
Measured on Various Gauge Lengths

Alloy * Designation	Number of Specimens	Average Elongation, %		Elongation, %
		4D	5D	
Misc.**	501	-	-	$E_{4D} = 0.37 + 0.97 E_{3.5D}$
AZ92-T6	221	2.9	2.2	$E_{5D} = -0.14 + 0.79 E_{4D}$
EZ33-T5	147	4.5	3.8	$E_{5D} = -0.22 + 0.89 E_{4D}$
ZK61-T6	509	9.7	8.3	$E_{5D} = 0.32 + 0.83 E_{4D}$

* According to CSA Codes H.1.1 - 1958 and H.1.2 - 1958.

** Alloys AZ80, AZ91 and ZK61 (various tempers).

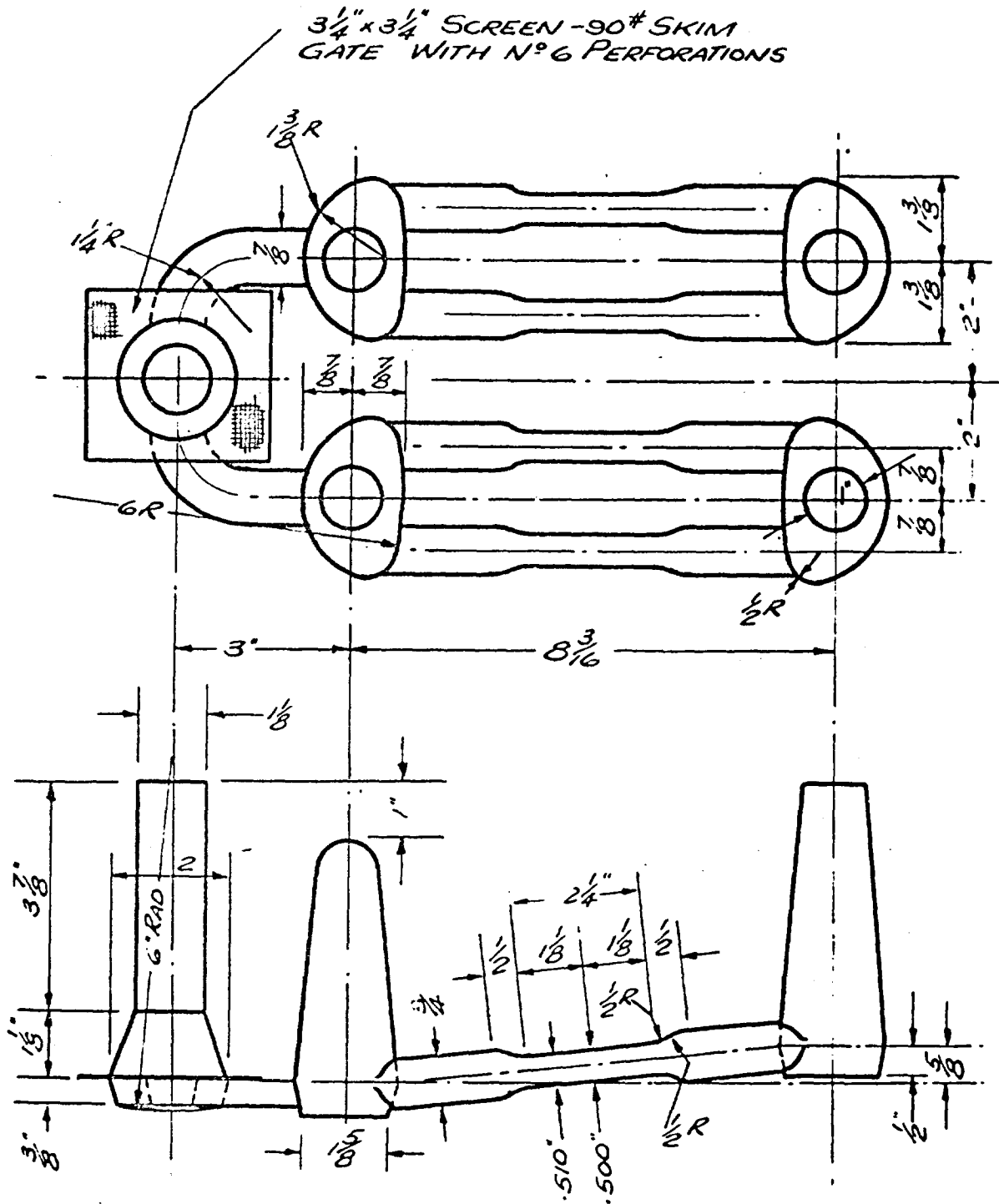

Figure 1. Test bar design according to CSA Standard
CSA.HG.1.5-1963(U. S. Federal Specification QQ-M-56).

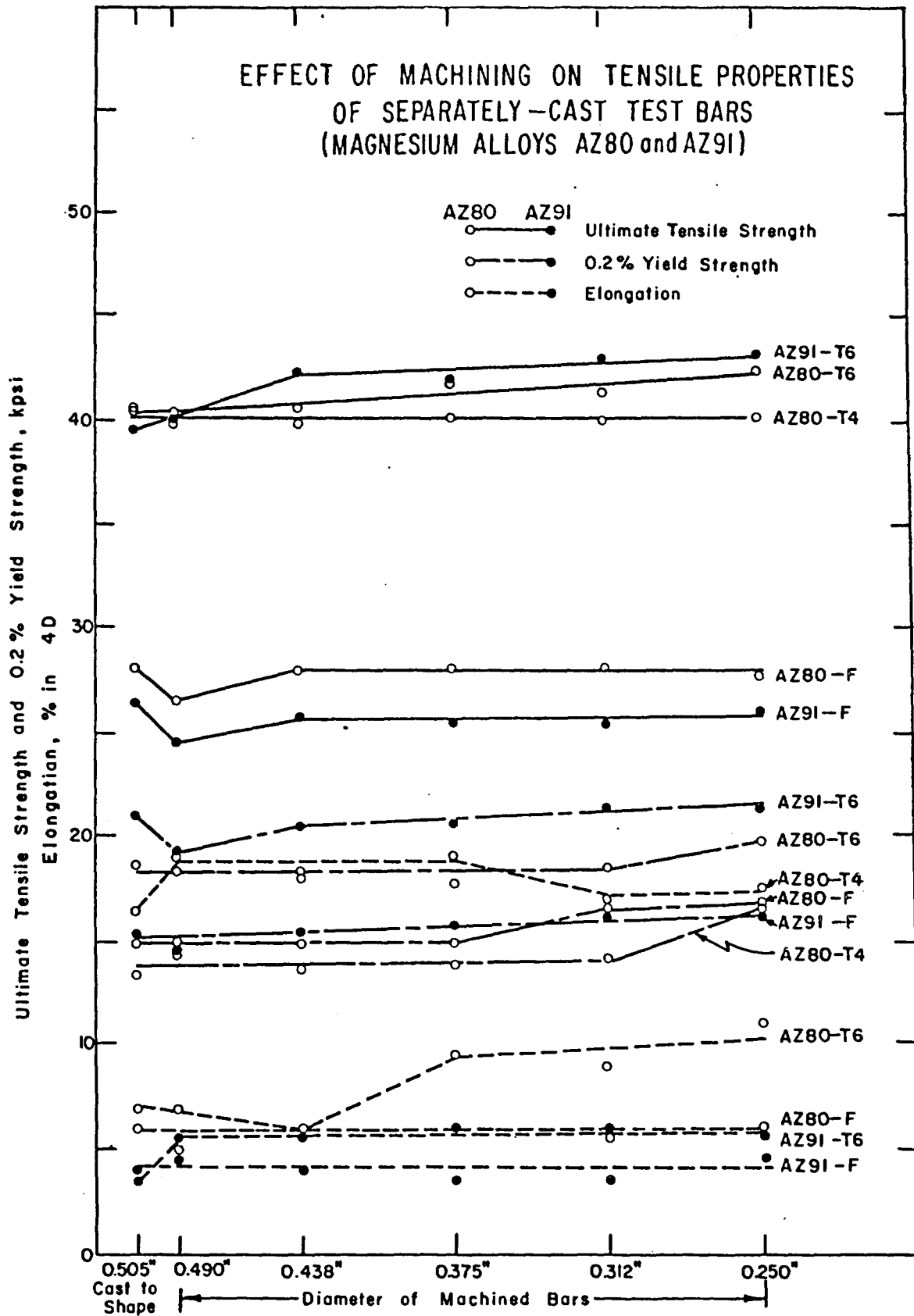

Figure 2. Effect of machining on tensile properties of separately-cast test bars (magnesium alloys AZ80 and AZ91).

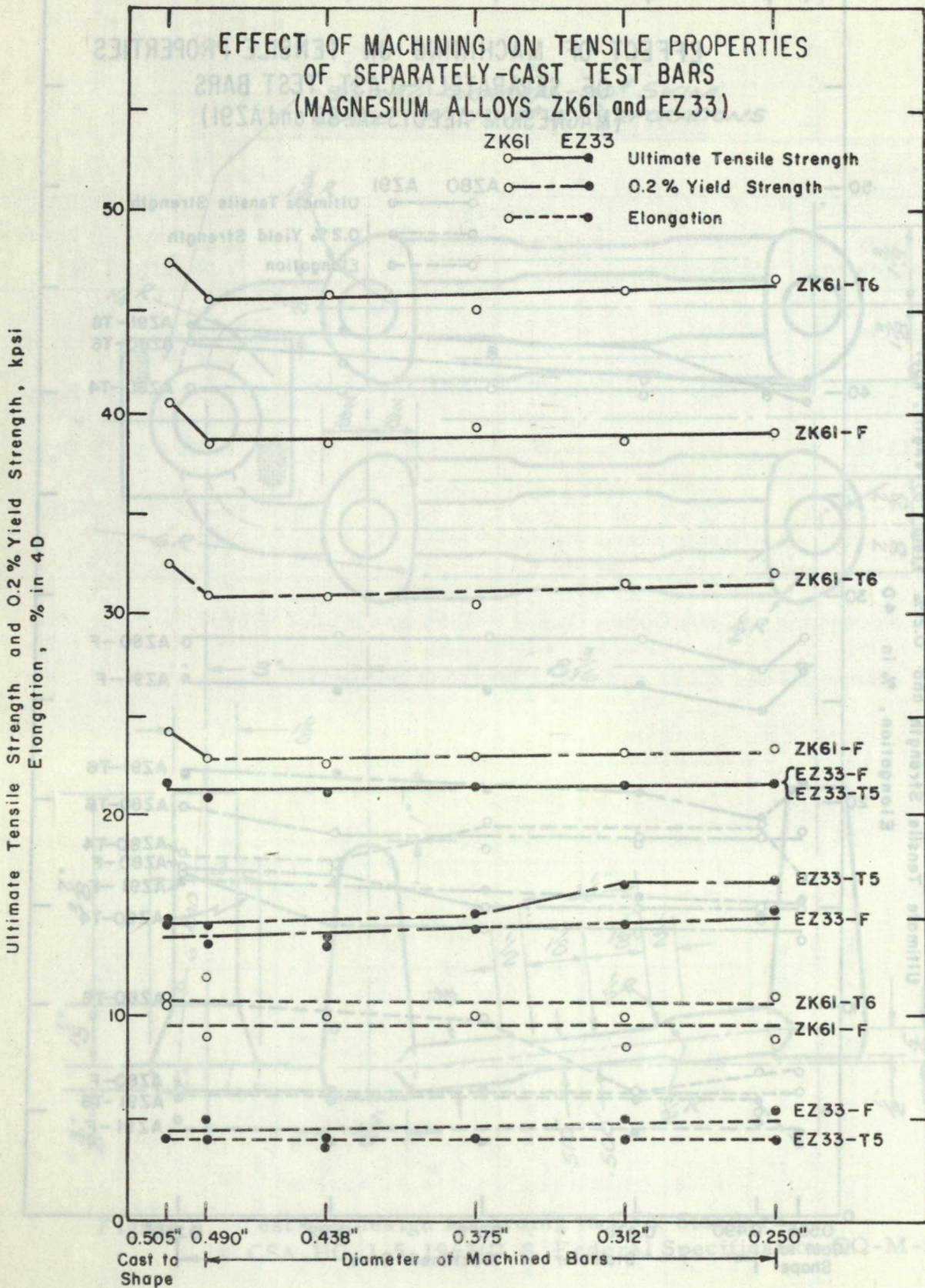
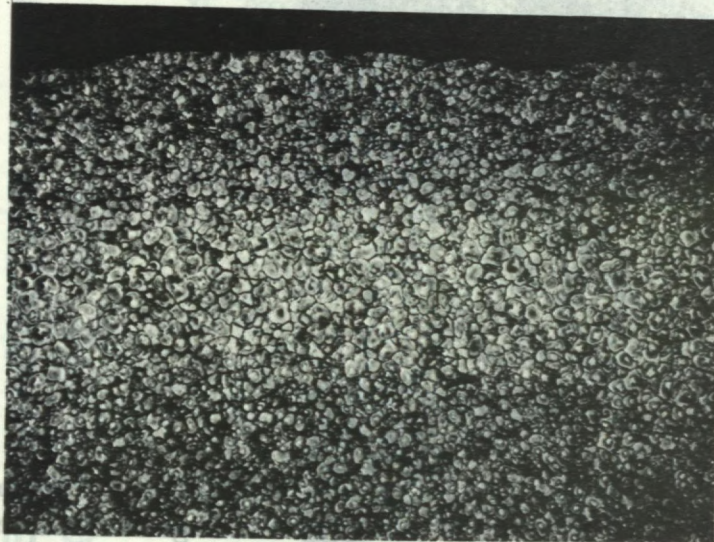

Figure 3. Effect of machining on tensile properties of separately-cast test bars (magnesium alloys ZK61 and EZ33).



X36

Figure 4. Section through reduced part of ZK61 test bar, etched 3 sec in 2:2.5:95.5 HF:HNO₃:H₂O. Note coarse-grained band at a short distance from edge.

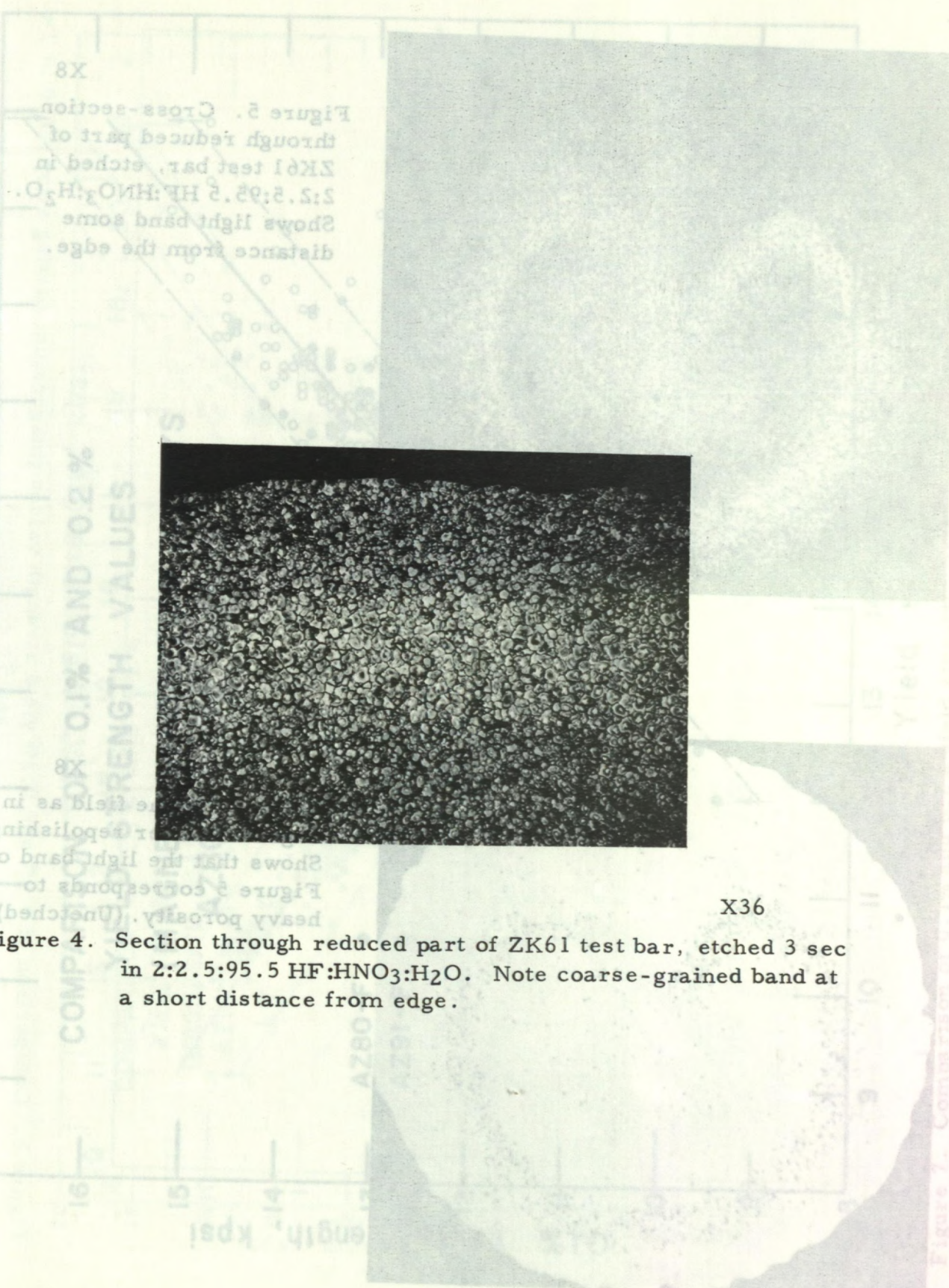

Figure 5. Cross-section through reduced part of ZK61 test bar, etched in 2:2.5:95.5 HF:HNO₃:H₂O. Shows light band some distance from the edge.

Figure 7. Comparison of grain structure in the necked and unnecked regions of a ZK61 test bar.



X8

Figure 5. Cross-section through reduced part of ZK61 test bar, etched in 2:2.5:95.5 HF:HNO₃:H₂O. Shows light band some distance from the edge.

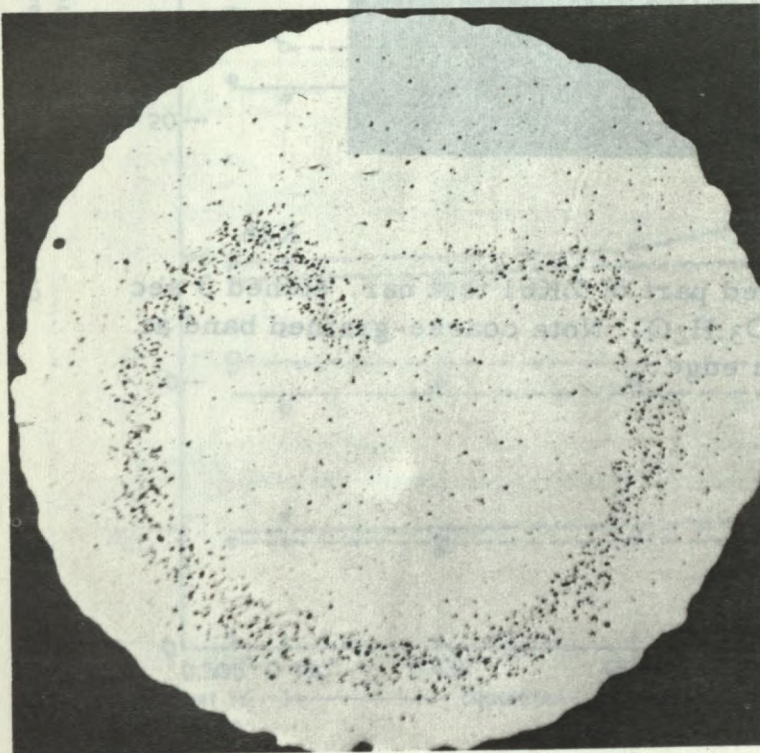

X8

Figure 6. Same field as in Figure 5, after repolishing. Shows that the light band of Figure 5 corresponds to heavy porosity. (Unetched).

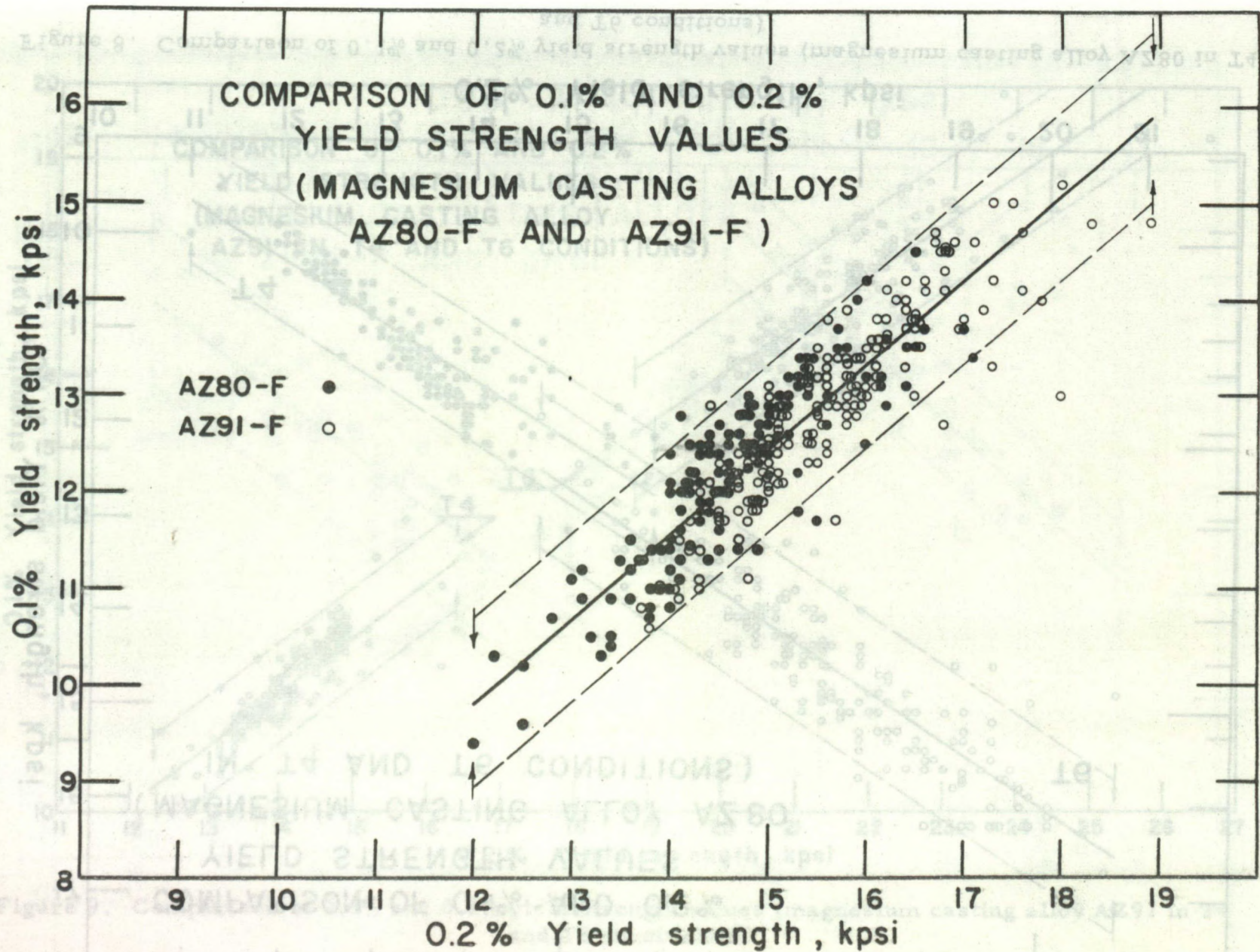

Figure 7. Comparison of 0.1% and 0.2% yield strength values (magnesium casting alloys AZ80-F and AZ91-F).

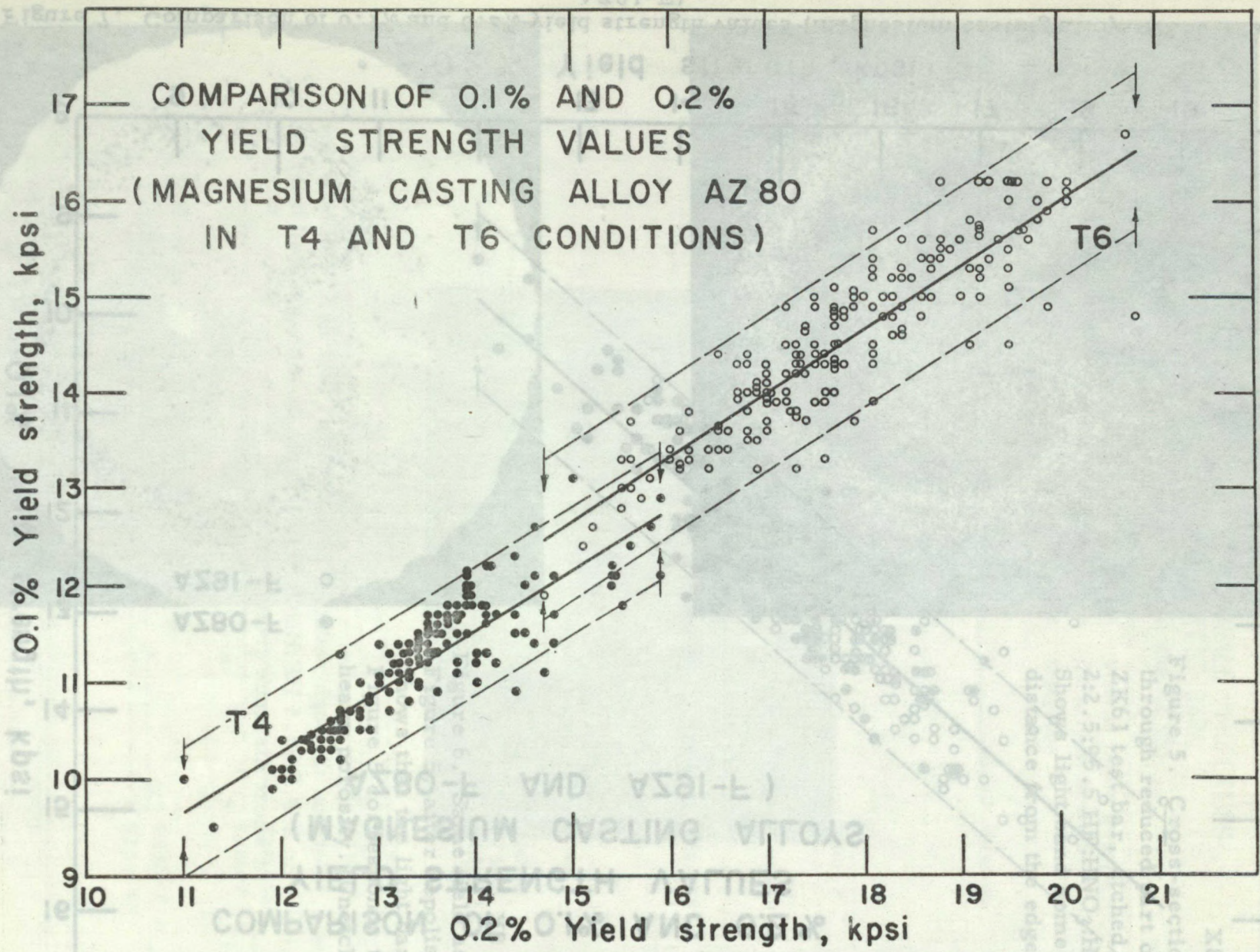

Figure 8. Comparison of 0.1% and 0.2% yield strength values (magnesium casting alloy AZ80 in T4 and T6 conditions).

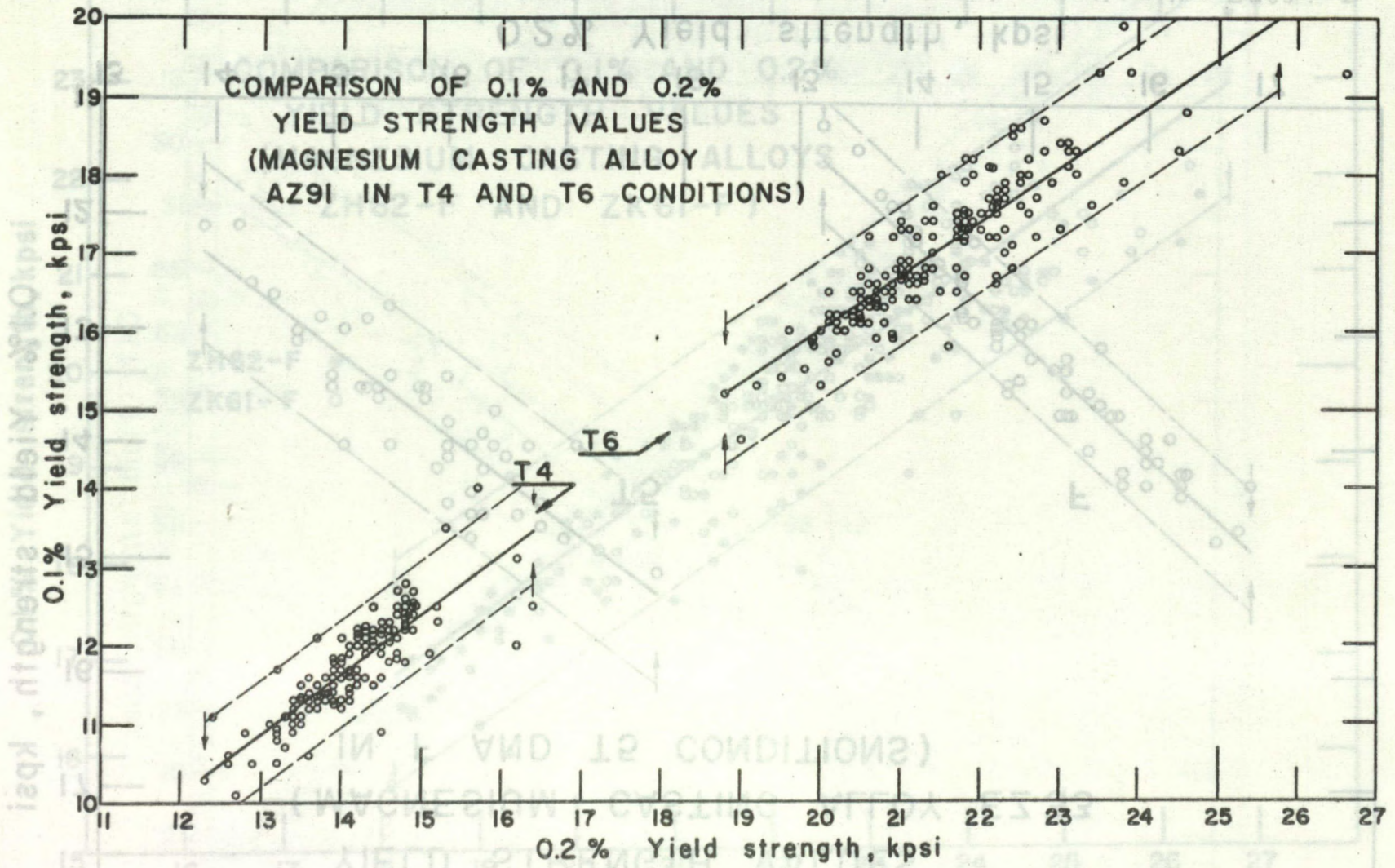

Figure 9. Comparison of 0.1% and 0.2% yield strength values (magnesium casting alloy AZ91 in T4 and T6 conditions).

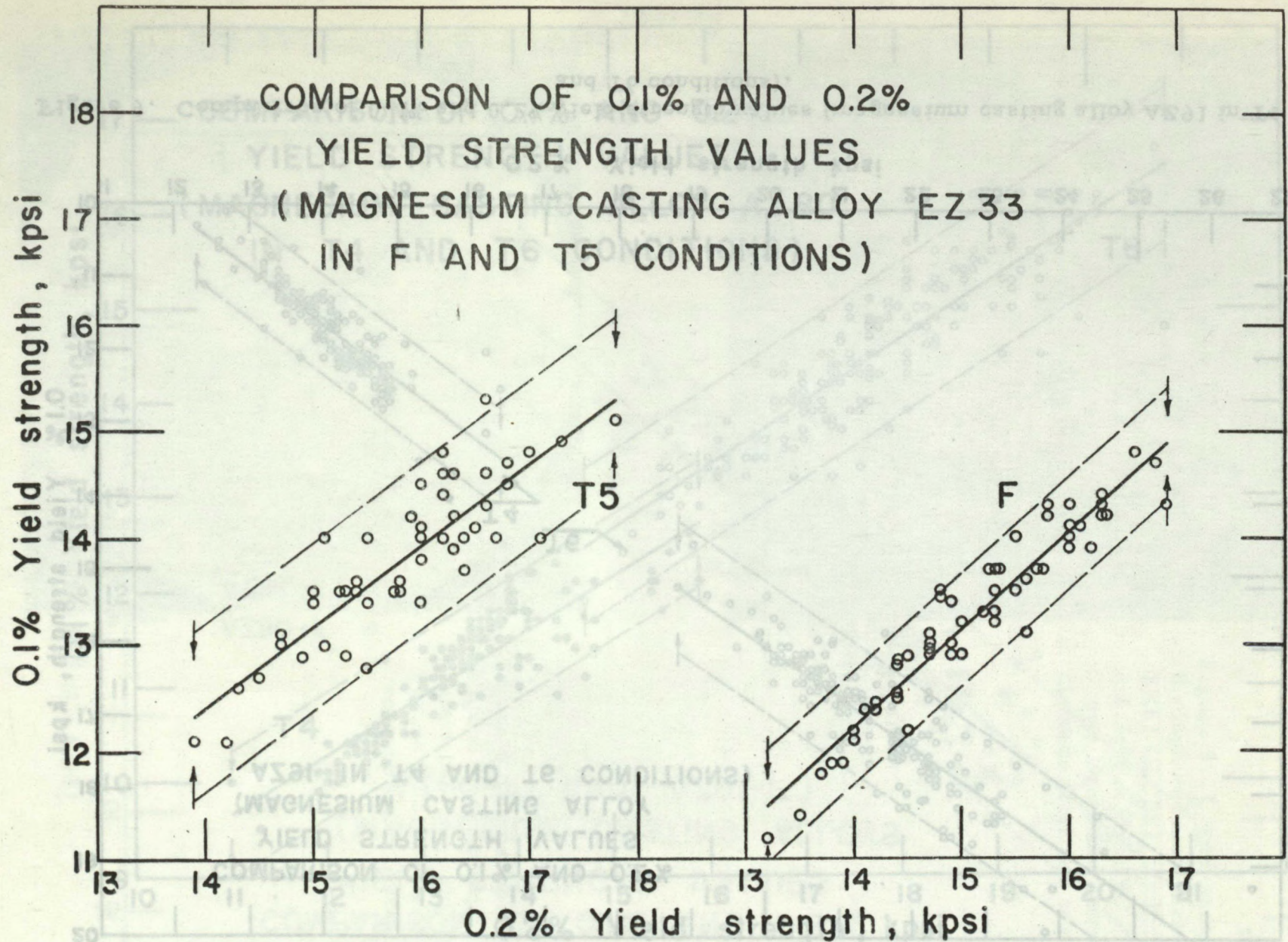

Figure 10. Comparison of 0.1% and 0.2% yield strength values (magnesium casting alloy EZ33 in F and T5 conditions).

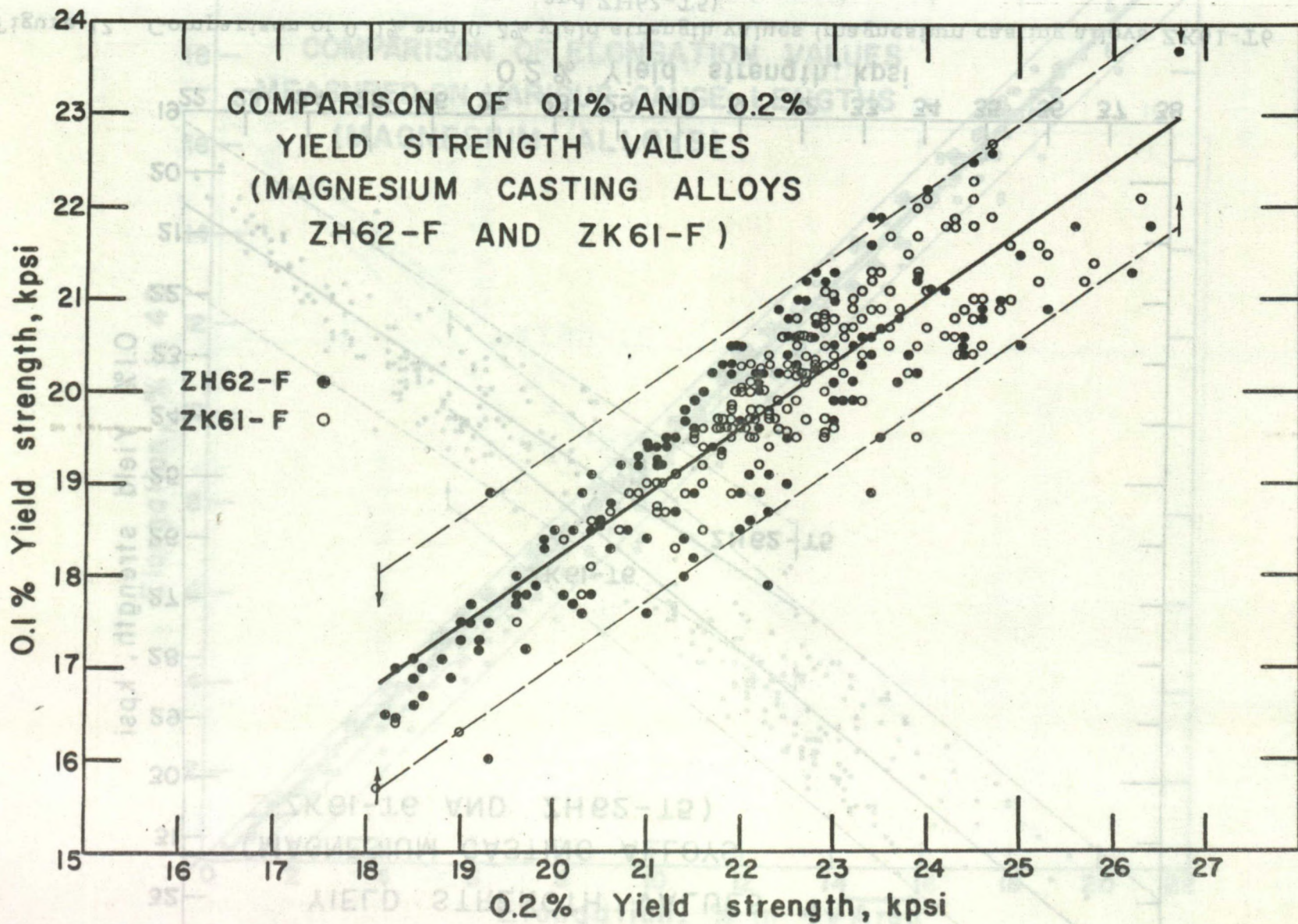

Figure 11. Comparison of 0.1% and 0.2% yield strength values (magnesium casting alloys ZH62-F and ZK61-F).

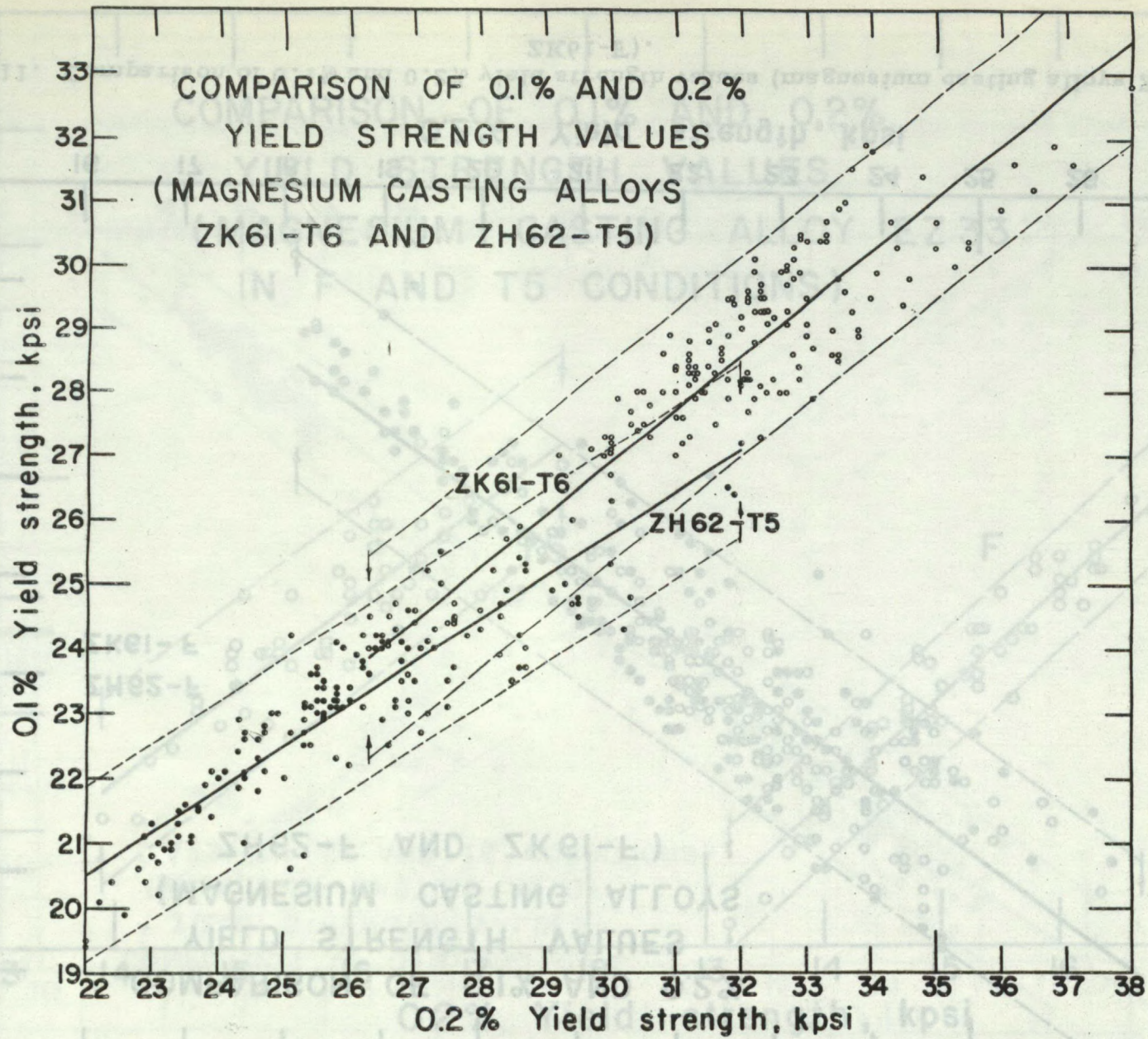

Figure 12. Comparison of 0.1% and 0.2% yield strength values (magnesium casting alloys ZK61-T6 and ZH62-T5).

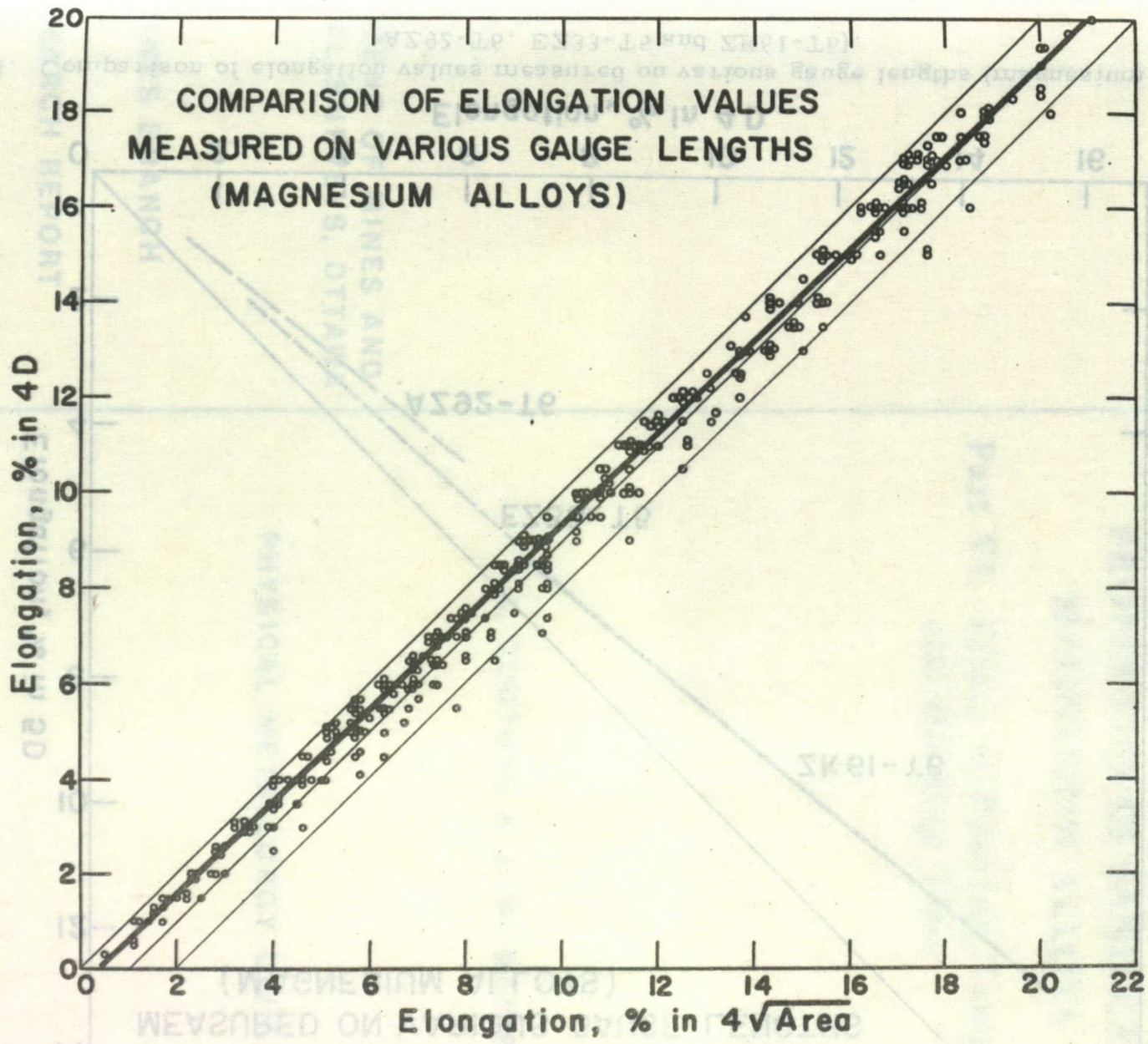

Figure 13. Comparison of elongation values measured on various gauge lengths (magnesium alloys).

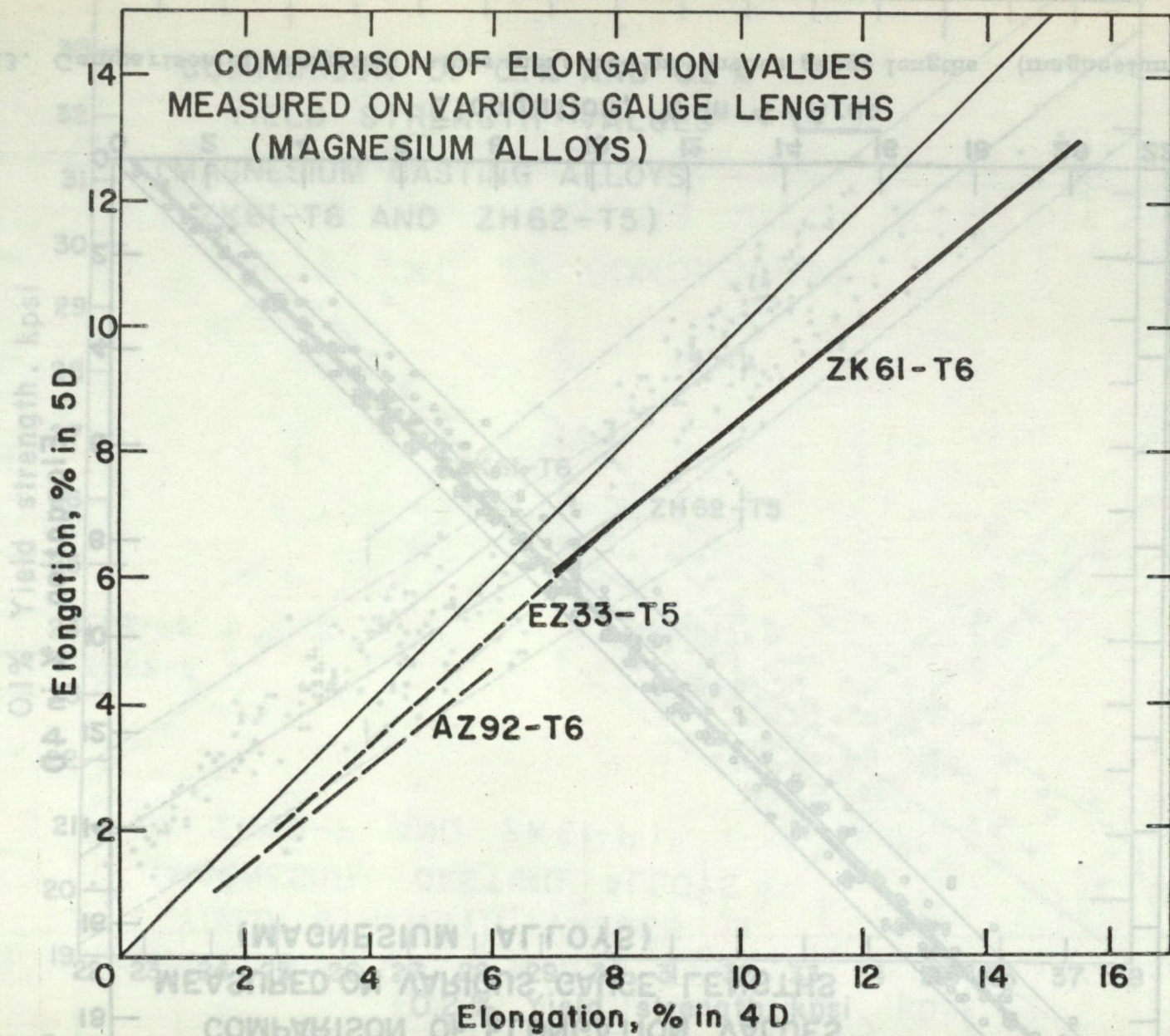

Figure 14. Comparison of elongation values measured on various gauge lengths (magnesium alloys AZ92-T6, EZ33-T5 and ZK61-T6).

DEP
ECH