



Ser  
622  
(21)  
C212rr

DEPARTMENT OF  
ENERGY, MINES AND RESOURCES

*dupl. file*

*Canada.*

*2* MINES BRANCH  
OTTAWA

## ARTIFICIAL SUPPORT OF ROCK SLOPES

K. BARRON, D. F. COATES AND M. GYENGE

MINING RESEARCH CENTRE

JULY 1970



© Crown Copyrights reserved

Available by mail from Information Canada, Ottawa  
and at the following Information Canada bookshops

HALIFAX

*1735 Barrington Street*

MONTREAL

*Aeterna-Vie Building, 1182 St. Catherine St. West*

OTTAWA

*171 Slater Street*

TORONTO

*221 Yonge Street*

WINNIPEG

*Mall Center Bldg., 499 Portage Avenue*

VANCOUVER

*657 Granville Street*

or through your bookseller

Price \$1.25

Catalogue No. M38-1/228

*Price subject to change without notice*

Information Canada  
Ottawa, 1970

## FOREWORD

It is well recognized that development projects are an order of magnitude more expensive than research projects. Consequently, R & D organizations must be particularly careful in selecting those prospects on which development funds will be expended.

In Canada, the majority of excavated rock slopes are in open-pit mines. Approximately 200 million tons of ore and 250 million tons of waste are currently being excavated from these open pits, which generate by these operations about 700 million dollars per annum. The cost of mining this ore is strongly influenced by the slope angle that is used for the pit walls. The benefits from research directed towards obtaining the capability of designing optimum slope angles are being obtained, but the technical problems that must be overcome to obtain the full capability are difficult.

The recommendation by the Mining Research Centre that their research on this subject be supplemented by the practical approach of developing support systems was fully approved. In the light of the modest amount of work that has now been done on this development, I am gratified to see the prospects that this work will lead to a distinct modification of current open-pit mining methods with consequent economic benefit to the country.

As has been the experience of the Mines Branch in much of its research, the active participation in this work by an operating company has been most beneficial. We believe the industry at large, as well as ourselves, should provide such companies with a hearty vote of thanks.

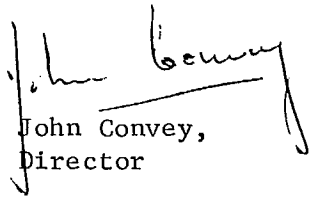
  
John Convey,  
Director

Ottawa, July 1970

## AVANT-PROPOS

Il est généralement admis que les travaux de développement sont considérablement plus coûteux que la recherche. Les entreprises de recherche et de développement doivent donc choisir avec soin les travaux auxquels elles comptent consacrer des fonds de développement.

Au Canada, la plupart des parois rocheuses résultant d'excavations sont dans des mines à ciel ouvert. On extrait actuellement quelque 200 millions de tonnes de minerai et 250 millions de tonnes de déblais de ces mines à ciel ouvert, dont les opérations annuelles représentent une valeur d'environ 700 millions de dollars. Le coût d'extraction de ce minerai dépend beaucoup de l'angle d'inclinaison de la paroi de l'excavation. La recherche a donné jusqu'ici de précieuses indications en vue d'obtenir le meilleur angle de pente possible, mais il reste d'importantes difficultés techniques à surmonter pour obtenir le rendement optimal.

La proposition du Centre de recherches minières voulant que ces recherches à ce sujet soient complémentées de travaux pratiques en vue de la mise au point de techniques de soutènement a été approuvée entièrement. A la lumière des quelques travaux déjà réalisés en ce sens, je suis heureux de constater qu'il pourrait en résulter une transformation radicale des méthodes d'excavation à ciel ouvert, entraînant des économies à l'échelle nationale.

Comme ce fut le cas pour la majeure partie des recherches de la Direction des mines, la participation active d'une entreprise en exploitation à ces travaux s'est révélée fort utile. Nous sommes d'avis que l'industrie en général, ainsi que le Centre de recherches minières, doivent remercier de telles entreprises de leur généreuse coopération.

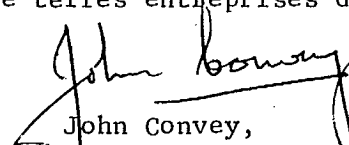

John Convey,  
Directeur

Ottawa, juillet 1970

Mines Branch Research Report R 228

ARTIFICIAL SUPPORT OF ROCK SLOPES\*

by

K. Barron\*, D. F. Coates\*\* and M. Gyenge\*

ABSTRACT

Part I of this research report gives some simple analyses and establishes some guidelines for designing support for hard rock slopes. Part II describes the installation of a trial support system and gives a breakdown of construction costs. Part III considers the design and costing of support systems for some hypothetical rock slopes. It is shown that the potential profits per linear foot of pit wall, obtained by using artificial supports to safely increase the slope angle, may be optimized.

---

\* Research Scientists, and \*\* Head, Mining Research Centre, Mines Branch, Department of Energy, Mines and Resources, Ottawa, Canada.

KEY WORDS: Slopes, supports, analysis, design, costs, profit, optimization.

Direction des mines

Rapport de recherches R 228

LE SOUTÈNEMENT ARTIFICIEL DES PAROIS ROCHEUSES

par

K. Barron\*, D. F. Coates\*\* et M. Gyenge\*

RÉSUMÉ

La première partie du présent rapport de recherche renferme certaines analyses simples et des directives générales sur le soutènement des parois rocheuses. La deuxième partie décrit l'installation d'un dispositif de soutènement d'essai et fait état de coût de sa construction. La troisième partie étudie le plan et le coût de dispositifs de soutènement pour diverses parois hypothétiques. Le rapport démontre que l'utilisation des supports artificiels pour accentuer l'angle de la parois des excavations permet d'augmenter le profit par pied linéaire.

---

\* Chercheurs scientifiques et \*\* Chef, Centre de recherches minières, Direction des Mines, ministère de l'Energie, des Mines et des Ressources, Ottawa, Canada.

**MOTS CLEFS:** Pente, soutènement, analyse, dessin, coûts, profit, optimisation.

## CONTENTS

|                          | <u>Page</u> |
|--------------------------|-------------|
| Foreword . . . . .       | i           |
| Avant-Propos . . . . .   | ii          |
| Abstract . . . . .       | iii         |
| Résumé (French). . . . . | iv          |
| PREFACE. . . . .         | ix          |

## PART I: DESIGN OF A SUPPORT SYSTEM

|  |    |
|--|----|
| The Basic Concept of the Support System. . . . . | 1  |
| General Assumptions. . . . .                     | 3  |
| Slope Stability Analysis . . . . .               | 5  |
| Cable Support Design . . . . .                   | 10 |
| Bench Stability Analysis . . . . .               | 17 |
| Design of the Welded Wire Mesh . . . . .         | 22 |
| Design of the Horizontal Stringers . . . . .     | 27 |
| Conclusion . . . . .                             | 31 |

## PART II: A TRIAL INSTALLATION OF A SLOPE SUPPORT SYSTEM

|  |    |
|--|----|
| Introduction . . . . .                                       | 33 |
| Plans for the Installation . . . . .                         | 34 |
| Instrumentation. . . . .                                     | 36 |
| Construction Sequence. . . . .                               | 37 |
| Critique on Construction Experience and Item Costs . . . . . | 39 |
| Site Preparation . . . . .                                   | 39 |
| Anchor Holes . . . . .                                       | 39 |
| Welded Wire Mesh . . . . .                                   | 41 |
| Steel Rod Stringer Beam and Abutments. . . . .               | 43 |
| Concrete Stringer Beam and Abutments . . . . .               | 44 |
| Anchors. . . . .   | 45 |
| Assembly and Installation of Anchors . . . . .               | 46 |
| Grouting of Anchors. . . . .                                 | 50 |
| Tensioning of the Anchors. . . . .                           | 52 |
| Final Grouting . . . . .                                     | 53 |
| Conclusion and General Comments. . . . .                     | 53 |
| Results of Instrumental Studies. . . . .                     | 59 |
| Instrument Layout. . . . .                                   | 59 |
| Cable Anchor Tensions. . . . .                               | 59 |
| Extensometer Measurements. . . . .                           | 69 |
| Concrete Strain Gauges . . . . .                             | 69 |
| Plate Load Tests . . . . .                                   | 79 |
| Television Viewing of the Boreholes. . . . .                 | 79 |
| Instrumentation Costs. . . . .                               | 79 |



## CONTENTS (Concluded)

|   | <u>Page</u> |
|---|-------------|
| PART III: EXAMPLES OF THE PRELIMINARY DESIGN AND COST<br>ESTIMATES FOR A MAJOR SUPPORT PROJECT                    |             |
| Introduction . . . . .  | 80          |
| The Hypothetical Problem . . . . .  | 80          |
| Slope Stability Analysis . . . . .  | 80          |
| Bench Stability Analysis . . . . .  | 86          |
| Cost Analysis. . . . .  | 92          |
| ACKNOWLEDGEMENTS . . . . .  | 102         |
| REFERENCES . . . . .  | 102         |
| APPENDICES: . . . . .   | 103-145     |
| I: Tendon characteristics . . . . .   | 103         |
| II: Bench stability analysis; angle $\phi^0$ at which excess shear<br>stress $\tau_e$ reaches a maximum . . . . . | 104         |
| III: Data on welded wire fabric . . . . .   | 106         |
| IV: Standard bars . . . . .   | 109         |
| V: Design properties of stressteel bars . . . . .   | 110         |
| VI: The load cells . . . . .  | 111         |
| VII: Sensitivities of Vibrating-Wire Extensometers . . . . .  | 115         |
| VIII: Photographic Record of Construction of Trial<br>Support Installation (43 photos) . . . . .                  | 117         |
| IX: Construction Costs of Trial Installation . . . . .  | 128         |
| X: Plate Load Tests . . . . .   | 132         |
| XI: Ontario Hydro Down-Hole Television Camera: An<br>Assessment . . . . .   | 141         |
| XII: Instrumentation Costs . . . . .  | 145         |



## FIGURES

| <u>No.</u>   | <u>Page</u> |
|--|-------------|
| 1. Schematic of rock anchor support system . . . . .   | 2           |
| 2. Assumed "area of influence" of cable anchor force . . . . .   | 6           |
| 3. Unit block on inclined plane. . . . .   | 7           |
| 4. Volume of rock requiring support. . . . .   | 7           |
| 5. Angle of plane of maximum excess shear stress, $i^{\circ}$ ,<br>for various slope angles $\alpha^{\circ}$ , and $\mu = 0$ to 1.0. . . . . | 9           |
| 6. n cables each apply force P to slope surface at<br>$\alpha^{\circ}$ , at $\Delta^{\circ}$ to horizontal. . . . .                          | 11          |
| 7. Orientation of discontinuous joint systems affects<br>calculation of cable lengths . . . . .  | 15          |
| 8. Calculation of cable lengths - cables numbered from<br>crest (1,2,---r, r+1,---n) . . . . .   | 15          |
| 9. Rock volume involved in bench stability analysis, $\phi < \alpha$ . . . . .   | 18          |
| 10. Rock volume involved in bench stability analysis, $\phi > \alpha$ . . . . .  | 19          |
| 11. Assumed action lines of mesh forces . . . . .  | 23          |
| 12. Cable assembly and installation time versus depth of<br>anchor hole, for 12/.5 cable tendons . . . . .                                   | 49          |
| 13. Instrument numbering and layout . . . . .  | 60          |
| 14. Extensometer anchor positions . . . . .  | 61          |
| 15. Strain gauge positions in concrete stringer beam. . . . .  | 62          |
| 16. Load cell No. 1 - 33-ft cable - initial load 267,600 lbs. . . . .  | 64          |
| 17. Load cell No. 2 - 110-ft cable - initial load 309,250 lbs . . . . .  | 65          |
| 18. Load cell No. 3 - 55-ft rod - initial load 113,500 lbs. . . . .  | 66          |
| 19. Load cell No. 4 - 195-ft cable - initial load 299,660 lbs . . . . .  | 67          |
| 20. Extensometer No. 1 . . . . .   | 70          |
| 21. Extensometer No. 2 . . . . .   | 71          |
| 22. Extensometer No. 3 . . . . .   | 72          |
| 23. Extensometer No. 4 . . . . .   | 73          |
| 24. Concrete gauges Nos. 1 and 2. . . . .  | 74          |
| 25. Concrete gauges Nos. 3 and 4. . . . .  | 75          |
| 26. Concrete gauges Nos. 5 and 6. . . . .  | 76          |
| 27. Concrete gauges Nos. 7 and 8. . . . .  | 77          |
| 28. Concrete gauges Nos. 9 and 10 . . . . .  | 78          |
| 29. Support costs per linear foot versus slope angle. . . . .  | 96          |
| 30. Profit per linear foot versus slope angle . . . . .  | 98          |
| 31. Comparison of profit per linear foot for cases with<br>and without mesh - over the benches. . . . .                                      | 101         |
| (In Appendices)  |             |
| A6.1. Schematic of the load cell. . . . .  | 114         |
| A6.2. Load cell calibration . . . . .  | 114         |
| A8. Photographic record of construction of trial support<br>installation - Photographs 1 to 43 . . . . .                                     | 117-127     |
| A10.1. Plate load test arrangement . . . . .   | 133         |
| A10.2. Displacements during plate load test cycles . . . . .   | 135         |
| A10.3. Surface displacements during plate load testing,<br>33-ft cable site . . . . .  | 136         |
| A10.4. Surface displacements during plate load testing,<br>110-ft cable site. . . . .  | 139         |
| A11.1. Measurements of slack in rod couplings . . . . .  | 142         |

## TABLES

| <u>No.</u>   | <u>Page</u> |
|--|-------------|
| 1. Percentage Cost of Each Phase of Construction . . . . .   | 55          |
| 2. Cost Estimating Data for Each Construction Phase. . . . .   | 57          |
| 3. Summary of Cable Support Design Guidelines. . . . .   | 85          |
| 4. Cost Estimates. . . . .   | 93-95       |
| 5. Excavation Saving and Profit/Linear Foot, by Use of Support . . .   | 97          |
| 6. Support Costs, Excavation Savings and Profit Per Linear<br>Foot - If No Mesh Used with Supports . . . . .                   | 100         |
| (In Appendices)  |             |
| A1.1. Tendon Characteristics. . . . .  | 103         |
| A3.1. Standard Styles of Welded Fabric, Showing Styles, Weights,<br>Spacing and Gauges of Wires, and Sectional Areas . . . . . | 106         |
| A3.2. Tables for Estimating Weight of Welded Wire Fabric. . . . .  | 107         |
| A3.3. Sectional Areas of Welded Wire Fabric . . . . .  | 108         |
| A4.1. Designations, Areas, Perimeters, and Weights of<br>Standard Bars. . . . .  | 109         |
| A4.2. Areas of Groups of Standard Bars, Square Inches . . . . .  | 109         |
| A5.1. Design Properties of Stressteel Bars. . . . .  | 110         |
| A10.1. Calculation of Modulus from Plate Load Displacements . . . . .  | 138         |
| A10.2. Moduli Determined for Surface Loading and Displacement<br>Measurements . . . . .  | 140         |
| A11.1. Slack in Rod Couplings . . . . .  | 142         |
| A12.1. Instrumentation Costs . . . . .   | 145         |

## PREFACE

If the slope angle of an open-pit mine can be increased by merely a few degrees, then there would be a considerable saving in costs resulting from the decreased cost of excavating superfluous waste rock and also, perhaps, from increased profits due to additional ore excavation at the toe. Most slope research work has therefore been directed towards the determination of slope angles which will optimize costs without endangering safety.

In underground mining, various methods of artificial support are used successfully, not only for maintaining safe working conditions, but also for reducing the amount of waste rock excavated. It is thus quite conceivable that artificial supports could be used in open-pit mining to enable steeper slopes to be safely mined, with the resulting economic benefits. Similarly, artificial support might enable an already steep slope to be safely maintained as the pit is deepened. Although artificial supports have been used by civil engineers in stabilizing excavations for building foundations and for stabilising dam abutments, they have not, as yet, been used in open-pit mines; this is probably due to a lack of information on how such support systems should be designed and on the costs. The latter is particularly important in mining since, if the support costs are greater than the economic benefits to be derived from the steeper slope, there is no advantage to be gained.

A preliminary benefit-cost assessment (1) has shown that in an open-pit mine of, say, 600-ft depth, an artificial support system allowing the average slope angle to be increased from  $45^{\circ}$  to  $50^{\circ}$  would cost approximately

\$1000 per linear foot of pit wall. This could result in a decrease in waste excavation costs of \$2000 per linear foot of wall (at \$0.34 per ton) or, alternatively, it might increase profit by approximately \$7,700 per linear foot of wall through increased ore extraction (at \$1.20 per ton). The change in net revenue could thus be between \$1000 and \$6,700 per linear foot of wall. With such incentives it is clear that a research programme is warranted which would be aimed at the development of suitable support systems. It is believed that such a support system can be designed with reasonable confidence, since it does not require new technological developments but would merely adapt established materials, anchor systems and construction methods to this use.

The first part of this report deals with the design concepts involved in using artificial supports in open-pit mines, and presents some relatively simple analyses which could enable a preliminary design to be made. However, it is emphasized that these analyses cannot be regarded as exact or complete but should be regarded as merely establishing engineering guidelines for design purposes. Any final design will always require a considerable degree of engineering judgement, based on site conditions, to be exercised.

In order to obtain experience with the construction techniques and to refine cost estimates on the basis of actual construction experience, a trial installation of a support system was planned. The second part of this report gives details of this trial, which was carried out in cooperation with an iron ore open-pit mine. The support system is described and details of its construction are given together with critical comments on each phase. A breakdown of construction costs is given and basic data for estimating construction costs have been derived.



In the third part of this report, some hypothetical pit slopes are considered and examples are given of how the analysis presented in Part I might be used to establish a preliminary design of supports for these slopes. The data derived in Part II are then used to estimate costs of these support systems and their relative economic returns.

PART I: DESIGN OF A SUPPORT SYSTEM

THE BASIC CONCEPT OF THE SUPPORT SYSTEM

It is emphasized that the following discussion is restricted to the consideration of hard rock slopes in which there are no major structural weaknesses. The walls of an open pit in such a rock mass can be considered to consist of a mass of tightly interlocked blocks of rock created by bedding and joint planes. On excavation of ore or waste, the confining stress on these blocks is removed, thus permitting some expansion and opening of joints and bedding planes. Damage from blasting, weathering, etc., on these open joints leads to the development of loose rock that will fall down any slope steeper than the angle of repose of such loose blocks. Consequently, for any extensive rock slope steeper than the angle of repose of this loose rock, some method should be provided to prevent rock falls causing damage.

Rock anchors, that are anchored in ground not subject to this surface expansion and that are preloaded, can provide some constraint to the surface rock that has expanded as a result of the excavation of the adjacent ground. In addition, if wire mesh is supported by horizontal stringers between these anchors it can contain the immediate surface loose that is developed but not stabilized by the anchors. In this way it should be possible to prevent rock falls on steep slopes.

Figure 1 illustrates the type of anchorage envisaged to achieve these ends. In this figure the slope has an overall angle of  $\alpha^{\circ}$ . It is assumed that there is a plane at some angle  $i^{\circ}$  beyond which the rock may still be regarded as a tightly interlocked competent mass. The object is therefore to install a series of deep bolts or cables which are anchored in this solid rock mass and to apply sufficient pre-load to these cables to support all the

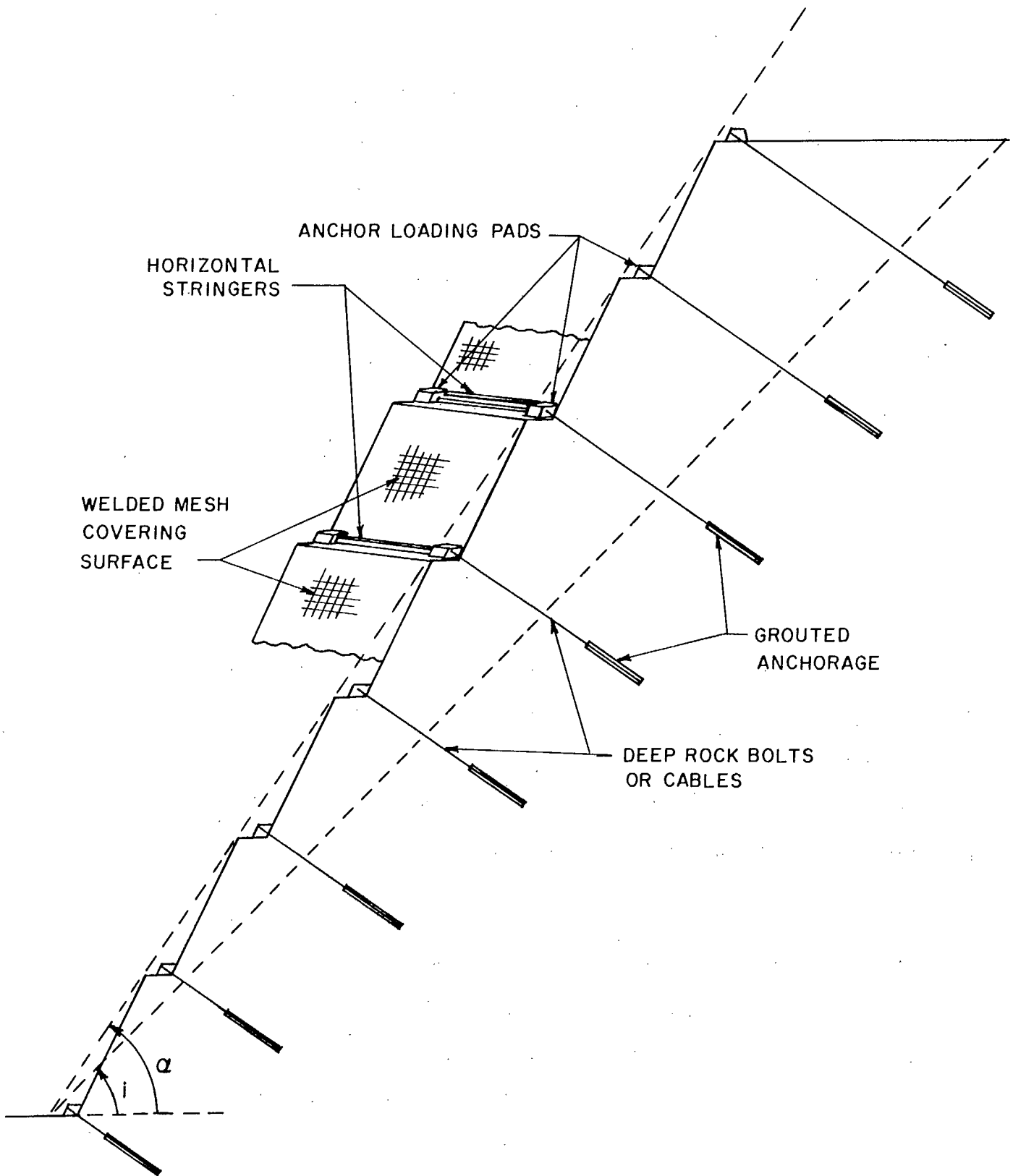

Figure 1. Schematic of rock anchor support system.

ground in excess of  $i^{\circ}$  (i.e. between  $i^{\circ}$  and  $\alpha^{\circ}$ ). Welded wire mesh placed over the surface and supported by horizontal stringers between the cable terminations would help control the immediate surface loose and would supply some degree of bench support.

#### GENERAL ASSUMPTIONS

To attempt even an approximate analysis of the stability of loose rock on the face of a slope, it is necessary to make a number of assumptions. In this study the following assumptions were made:

(i) It was assumed that there is a plane at some angle  $i^{\circ}$  beyond which the rock can be regarded as a competent mass. The choice of the angle  $i^{\circ}$  will be considered later.

(ii) It was assumed that the plane at  $i^{\circ}$  passing through the toe of the slope is a potential plane of shear failure.

(iii) It was assumed that the mass of loose rock between  $i^{\circ}$  and  $\alpha^{\circ}$  can be regarded as a rigid body sliding on the plane at  $i^{\circ}$  and that the coefficient of friction on this surface is given by  $\mu$ . The estimation of the coefficient of friction is important in practical applications of the ensuing analysis. There can be a considerable variation between the coefficients of friction for rock masses even of the same general type. When the pit wall is composed of different types of rock, an even larger variation might be expected. The degree of alteration of these different rock types also adds to the uncertainty. Consequently it is not possible to establish a friction coefficient applicable to the whole open pit, even with the most elaborate field measurements. A coefficient of friction obtained by the most sophisticated in-situ method would only apply for the location represented by the testing site.



In view of this wide variation it is not unreasonable to assume, at the preliminary design stage, that  $\mu$  is given by the easily obtainable coefficient of friction derived from small-scale laboratory tests between rough sawn surfaces of rocks (2,3,4). For instance, Patton (3) concluded that "the range of values computed from field observations on unstable slopes compares favourably with the values obtained from sliding tests on wet, rough sawn, rock surfaces in the laboratory".

(iv) It is assumed that the cohesion on the plane at  $i^0$  is zero. The wall of an open pit consists of variable sizes of blocks separated by bedding and joint planes. Even without support, cohesion might exist on these planes, at least temporarily, until joints open up as a result of relaxation due to the removal of the lateral support by excavation. Further, if the incipient failure surface does not coincide with the joint planes, then some cohesion must exist. A proper installation of the proposed support system would minimize the lateral expansion of the surface blocks, and the existing cohesion between the blocks would be at least partially retained. However, in the following analysis cohesion has been ignored. The partial retention of cohesion in practice should therefore add to the safety factor of the design.

(v) Some assumption must be made as to how the applied cable force is distributed in the rock mass. Since the size of the bearing plate at the cable end is relatively small, the cable force may be regarded as a point load on the rock surface.

To define the volume of rock restrained by the cable anchors, as opposed to that which must be supported by the wire mesh, a simplified three-dimensional stress distribution was used wherein the cable force is assumed to be acting only on the volume of rock contained within a  $90^0$

circular cone. This is illustrated in Figure 2.

However, to define the effect of multiple cable forces on the assumed incipient failure plane at  $i^0$ , it was assumed that the total force from all cables was uniformly distributed over the plane at  $i^0$ . Whilst this is an oversimplification of the actual stress distribution on this plane, it is believed that this assumption is as adequate as any more sophisticated solution and does, at least, offer the advantage of simplicity.

#### SLOPE STABILITY ANALYSIS

If a unit cube of weight  $\gamma$  lbs/cu ft is resting on a plane at  $i^0$  to the horizontal (see Figure 3), then this block will slide if the component of weight down the slope,  $T$ , becomes greater than the resisting force  $S$ . If  $\mu$  is the coefficient of friction and  $N$  is the normal component of weight, then  $S = \mu N$ , assuming zero cohesion. For a safety factor of unity these forces cancel out when  $\mu = \tan i$ . For any initial arbitrary angle  $i^0$ , the excess shear force,  $f_e$ , acting down the slope, per unit cube, is thus given by:

$$f_e = T - \mu N = \gamma(\sin i - \mu \cos i) \quad (1)$$

Now, for a slope of depth  $Z$  feet and overall slope angle  $\alpha^0$  with an incipient failure plane at  $i^0$  ( $i^0 < \alpha^0$ ), the volume of rock,  $V$ , per unit thickness of section is given, as illustrated in Figure 4, by:

$$V = \frac{Z^2}{2} \{ \cot i - \cot \alpha \} \quad (2)$$

(This neglects slight variations due to bench configuration.)

Hence, if the volume of rock can be regarded as a rigid body sliding on the plane at  $i^0$ , the total excess shear force,  $F_e$ , per unit thickness of section,

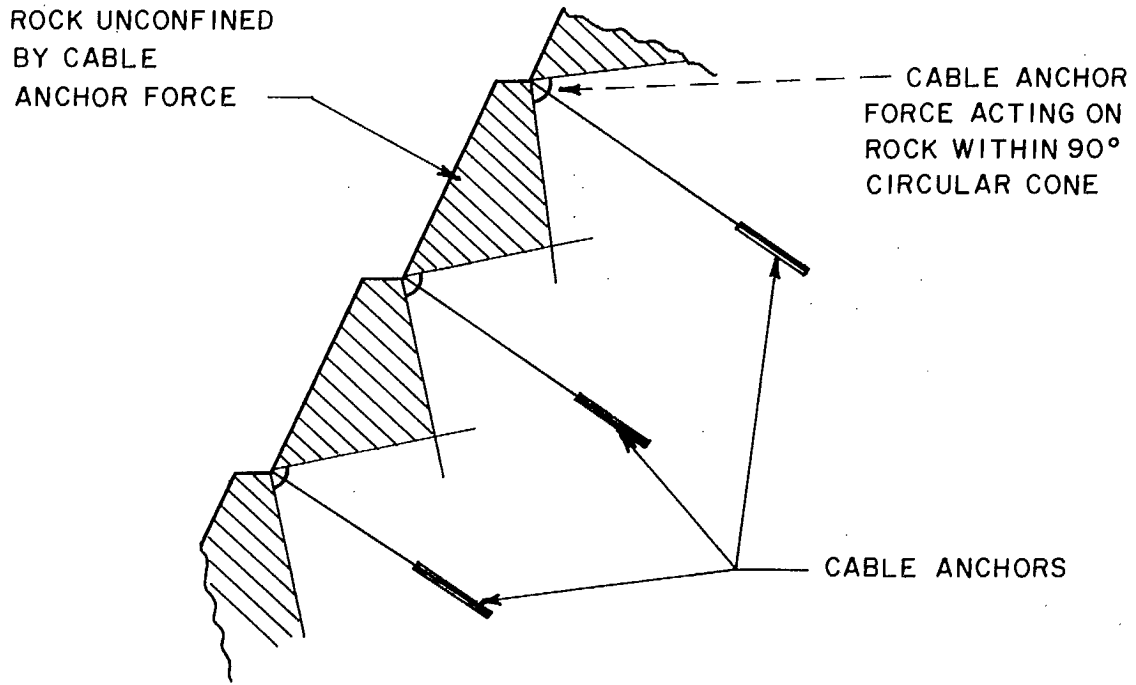

Figure 2. Assumed "area of influence" of cable anchor force.

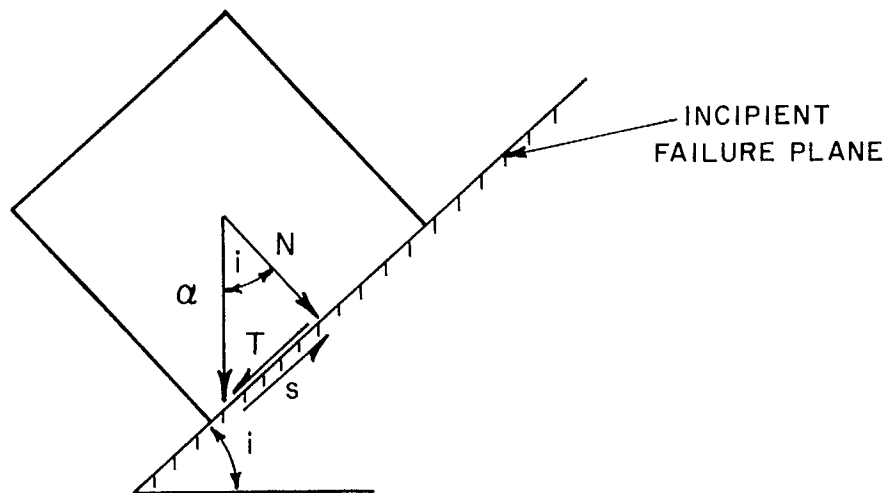

Figure 3. Unit block on inclined plane.

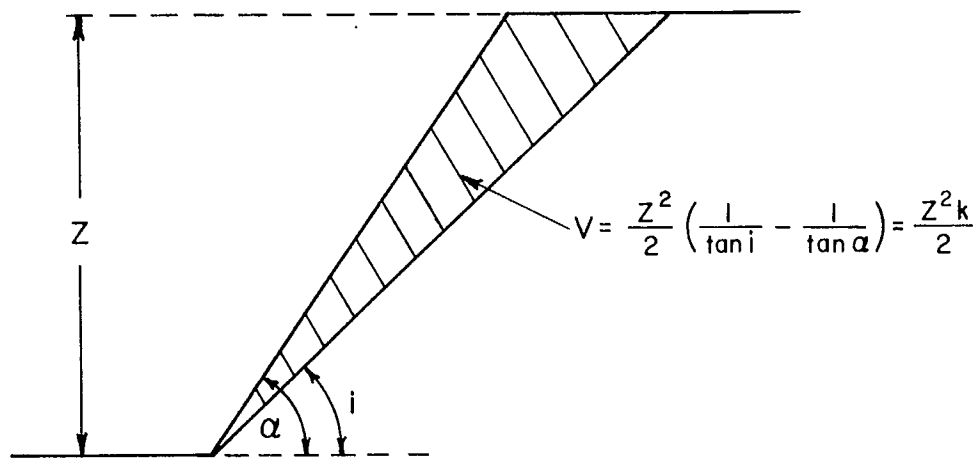

Figure 4. Volume of rock requiring support.



is given from equations (1) and (2) as:

$$F_e = V_{fe} = \frac{YZ^2}{2} \{ \cot i - \cot \alpha \} \{ \sin i - \mu \cos i \} \quad (3)$$

The average excess shear stress,  $\tau_e$ , over the plane at  $i^\circ$ ,  $= F_e/A$  where  $A$  is the area of this plane and equals  $Z/\sin i$ . Hence the average excess shear stress is given by:

$$\tau_e = \frac{F_e}{A} = \frac{ZY}{2} \{ \cot i - \cot \alpha \} \{ \sin^2 i - \mu \sin i \cos i \} \quad (4)$$

It is seen from equation (4) that the excess shear stress varies with the angle  $i^\circ$ , the slope angle  $\alpha^\circ$ , and the coefficient of friction  $\mu$ . For any particular slope angle  $\alpha$  and coefficient of friction  $\mu$ , there will be some value of  $i^\circ$  at which the excess shear stress reaches a maximum value. This maximum value should be determined and the support system designed so that this maximum excess shear stress is eliminated by the applied forces.

For any constant values of  $\alpha$  and  $\mu$ ,  $\tau_e$  will be a maximum when  $\frac{\partial \tau_e}{\partial i} = 0$ . Thus, differentiating equation (4) with respect to  $i$  and equating to zero gives:

$$\begin{aligned} \frac{\partial \tau_e}{\partial i} = 0 &= \frac{ZY}{2} \left\{ \frac{-1}{\sin^2 i} \right\} \{ \sin^2 i - \mu \cos i \sin i \} \\ &+ \frac{ZY}{2} \{ \cot i - \cot \alpha \} \{ 2 \sin i \cos i - \mu \cos^2 i + \mu \sin^2 i \} \\ \text{i.e., } 0 &= \{ \mu \cot i - 1 \} + \cot i \{ \sin 2i + \mu \cos 2i \} - \cot \alpha \{ \sin 2i + \mu \cos 2i \} \\ \text{i.e., } \cot \alpha &= \cot i + \left\{ \frac{\mu \cot i - 1}{\sin 2i + \mu \cos 2i} \right\} \quad (5) \end{aligned}$$

Equation (5) defines the angle  $i^\circ$  at which the excess shear stress is a maximum for any values of  $\alpha$  and  $\mu$ . This angle  $i$  has been calculated for all values of  $\alpha$  between  $0^\circ$  and  $90^\circ$  for a range of values of  $\mu$  from 0 to 1, bearing in mind that  $\alpha \geq i$ ; these results are plotted in Figure 5.

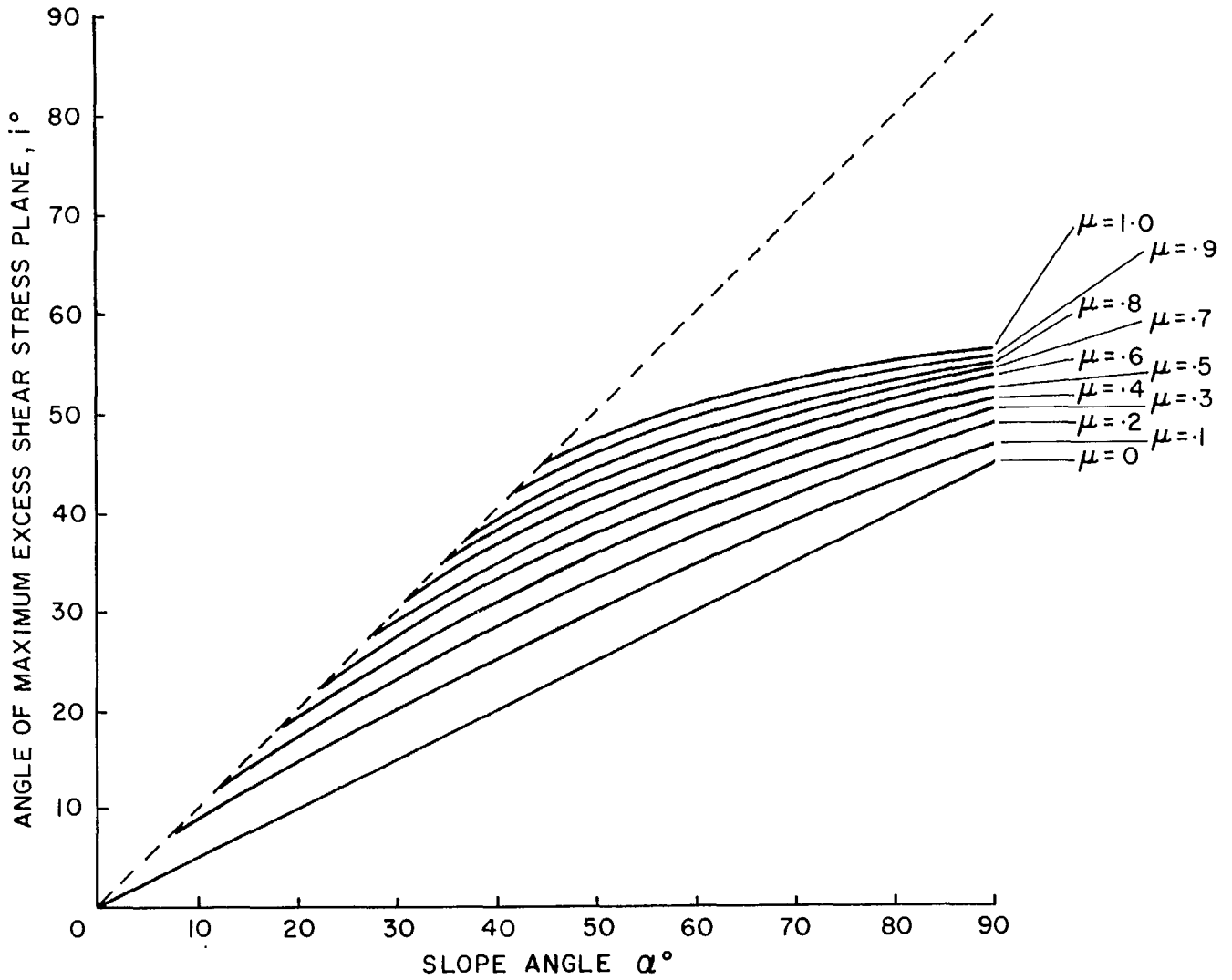

Figure 5. Angle of plane of maximum excess shear stress,  $i^\circ$ , for various slope angles  $\alpha^\circ$ , and  $\mu = 0$  to 1.0.

For example: If the overall slope angle is  $55^\circ$  and  $\mu = 0.7$ , then, from Figure 5, the plane of maximum excess shear stress occurs at  $i = 45^\circ$ . Likewise if  $\alpha = 60^\circ$  and  $\mu = 0.7$ , then  $i = 46\frac{1}{2}^\circ$ .

Hence, given  $\alpha$  and  $\mu$ , the angle of the plane of maximum excess shear stress can be determined from equation (5) or from Figure 5. From this value of  $i^\circ$ , using equation (4) the magnitude of this maximum excess shear stress can be calculated. It is this value of the excess shear stress which must be eliminated by the application of the cable forces in order to achieve a stable slope.

#### CABLE SUPPORT DESIGN

For a safety factor of unity the applied support forces should exactly eliminate the maximum excess shear stress on the plane at  $i^\circ$ . Suppose, therefore, that  $n$  cables, equally spaced by a vertical distance  $a$ , each apply a force  $P$  to the surface of a slope at an angle  $\Delta^\circ$  to the horizontal (see Figure 6). Let the lateral spacing of the cables be  $l$ . Assuming that the total applied force,  $nP$ , is uniformly distributed over the area of the incipient failure plane at  $i^\circ$ , then the total stress  $\sigma$  acting on this plane is given by:

$$\sigma = \frac{nP}{l(a/\sin i)} = \frac{nP \sin i}{a l}$$

Thus, resolving into stress components normal and tangential to the plane at  $i^\circ$  gives:

The normal component of stress on the plane  $\sigma_N = \frac{nP}{al} \sin i \sin (i + \Delta)$

and the tangential component of stress on the plane  $\tau = \frac{nP}{al} \sin i \cos (i + \Delta)$ .

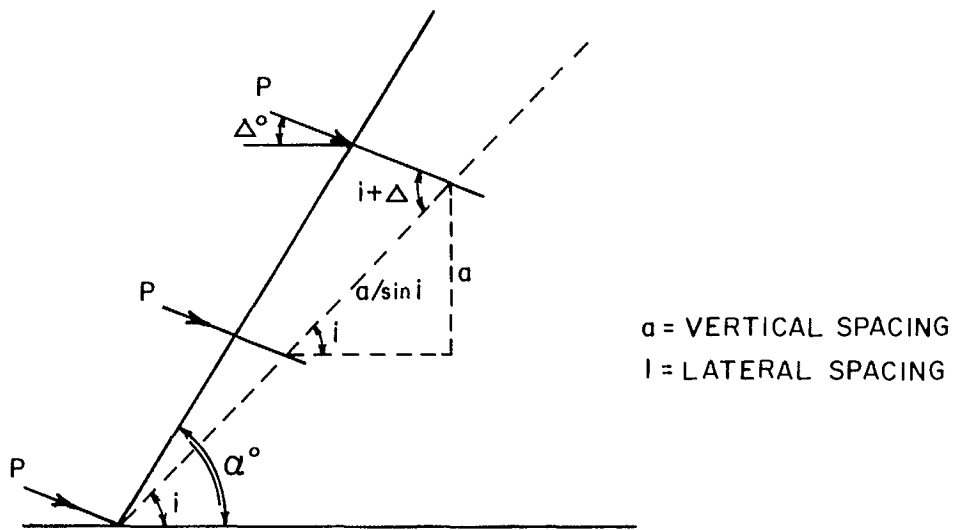

Figure 6.  $n$  cables each apply force  $P$  to slope surface at  $\alpha^\circ$ , at  $\Delta^\circ$  to horizontal.



Hence the total shear resistance mobilized by the cable forces,  $\tau_p$ , is given by:

$$\tau_p = \tau + \mu \sigma_N$$

$$\text{i.e., } \tau_p = \frac{nP}{a1} \sin i \{ \cos (i+\Delta) + \mu \sin (i+\Delta) \} \quad (6)$$

Now,  $\tau_p$  given by equation (6) will vary with the angle  $\Delta$  of the applied forces to the horizontal. However,  $\tau_p$  will reach a maximum, for a given angle  $i^\circ$ , when  $\partial \tau_p / \partial \Delta = 0$ . Thus, differentiating equation (6) and equating to zero gives:

$$\frac{\partial \tau_p}{\partial \Delta} = 0 = \frac{nP}{a1} \sin i \{ -\cos i \sin \Delta - \sin i \cos \Delta \} + \frac{\mu nP \sin i}{a1} \{ -\sin i \sin \Delta + \cos i \cos \Delta \}$$

$$\text{i.e. } \mu = \frac{\{ \tan \Delta + \tan i \}}{\{ 1 - \tan \Delta \tan i \}} = \tan (i + \Delta) \quad (7)$$

i.e. The shear resistance mobilized by the cable forces reaches a maximum if  $\Delta$  is chosen such that  $\mu = \tan (i + \Delta)$ ; e.g., if the overall slope  $\alpha = 55^\circ$  and  $\mu = 0.7$ , then, from Figure 5,  $i = 45^\circ$ . Thus for maximum resistance to be mobilized by the cables:

$$0.7 = \tan (45 + \Delta)$$

$$\text{i.e. } 45 + \Delta = 35^\circ; \quad \text{i.e. } \Delta = -10^\circ;$$

i.e., ideally in this case the cables should be installed in holes drilled  $10^\circ$  'up dip'. Now from a practical point of view this may not be possible, since it is not known whether it is practical to install cables in holes up dip.

Hence, if this solution yields a value of  $\Delta$  which is impractical from installation considerations, a compromise should be made by choosing  $\Delta$  as near to the ideal as is practically possible. For example, in the above case it is probably practical to install cables in holes at an angle  $\Delta = +5^\circ$ , i.e.  $5^\circ$

down dip. This, whilst not the ideal solution, would be a much preferred situation to installing the cables, say, normal to the pit slope ( $\alpha = 55^\circ$ ,  $\Delta = 35^\circ$ ).

For a safety factor of unity, the total shear resistance mobilized by the cable forces should exactly equal the average excess shear stress in the plane at  $i^\circ$ . Thus equating  $\tau_p = \tau_e$ , from equations (4) and (6), gives:

$$\frac{Z\gamma}{2} \{ \cot i - \cot \alpha \} \{ \sin^2 i - \mu \sin i \cos i \} = \frac{nP}{al} \{ \sin i \cos(i+\Delta) + \mu \sin i \sin(i+\Delta) \}$$

$$\text{or } a \cdot l = \frac{2nP}{Z\gamma} \left\{ \frac{\sin i \cos(i+\Delta) + \mu \sin i \sin(i+\Delta)}{[\cot i - \cot \alpha][\sin^2 i - \mu \sin i \cos i]} \right\} \quad (8)$$

This equation defines the relative horizontal and vertical cable spacings required to support the rock slope with a safety factor of unity. From a practical point of view, the spacing of the cables vertically (distance  $a$ ) should be either full-bench or half-bench height. The lateral spacing is then decided from equation (8). Further, if there are  $n$  cables spaced vertically on full-bench spacing and the pit wall has benches all of equal height, then there will be  $(n-1)$  benches and the vertical spacing  $a = Z/(n-1)$ , where  $Z$  is the pit depth. Likewise, if the cables are spaced vertically every  $\frac{1}{2}$  height of the bench, then the number of benches is  $\frac{(n-1)}{2}$  and  $a = 2Z/(n-1)$ . Hence, from equation (8), substituting for  $a$ , the lateral spacing of the cables is given by:

(a) For full-bench vertical spacing

$$l = \frac{2n(n-1)P}{Z^2\gamma} \left\{ \frac{\sin i \cos(i+\Delta) + \mu \sin i \sin(i+\Delta)}{[\cot i - \cot \alpha][\sin^2 i - \mu \sin i \cos i]} \right\} \quad (9)$$

when  $n$  = number of cables, and  $(n-1)$  = number of benches.

(b) For half-bench vertical spacing

$$l = \frac{n(n-1)P}{Z^2 \gamma} \left\{ \frac{\sin i \cos (i+\Delta) + \mu \sin i \sin (i+\Delta)}{[\cot i - \cot \alpha][\sin^2 i - \mu \sin i \cos i]} \right\} \quad (10)$$

where  $n$  = number of cables and  $\frac{(n-1)}{2}$  = number of benches.

The above criteria are derived for a safety factor of unity. The safety factor can be regarded as the ratio of the mobilized shear resistance  $\tau_p$  to the excess shear stresses  $\tau_e$ . Hence, from equations (4) and (6):

$$\text{Safety factor } S_F = \frac{\tau_p}{\tau_e} = \frac{2nP}{aZ\gamma} \frac{\{\cos (i+\Delta) + \mu \sin (i+\Delta)\}}{(\cot i - \cot \alpha)(\sin i - \cos i)} \quad (11)$$

Thus, if the design is to be made according to a chosen safety factor other than unity, then the lateral spacing of the cables should be accordingly reduced.

Consider now the required cable lengths. It has been tacitly assumed, in the above analysis, that the plane of maximum excess shear stress is the plane beyond which the rock may be considered to be solid competent mass and that this plane at  $i^0$  is the incipient failure plane. Now, if the slope contains a system of, say, discontinuous joints oriented at  $\beta^0$  to the horizontal, then if  $\beta > i^0$ , as illustrated in Figure 7(a), it is thought that this tacit assumption is valid. Thus in this case the cable lengths should be designed to extend beyond the plane at  $i^0$  plus, of course, the manufacturer's recommended length,  $x$  ft, for the cable anchorage. If the cables are numbered from 1 to  $n$ , starting at the crest, then by geometry, as shown in Figure 8, the length of the  $r$ th cable is given by:

$$L_r = \left[ \frac{\{Z - (r-1)a\} \sin (\alpha - i)}{\sin \alpha \sin (i+\Delta)} \right] + x \quad (12)$$

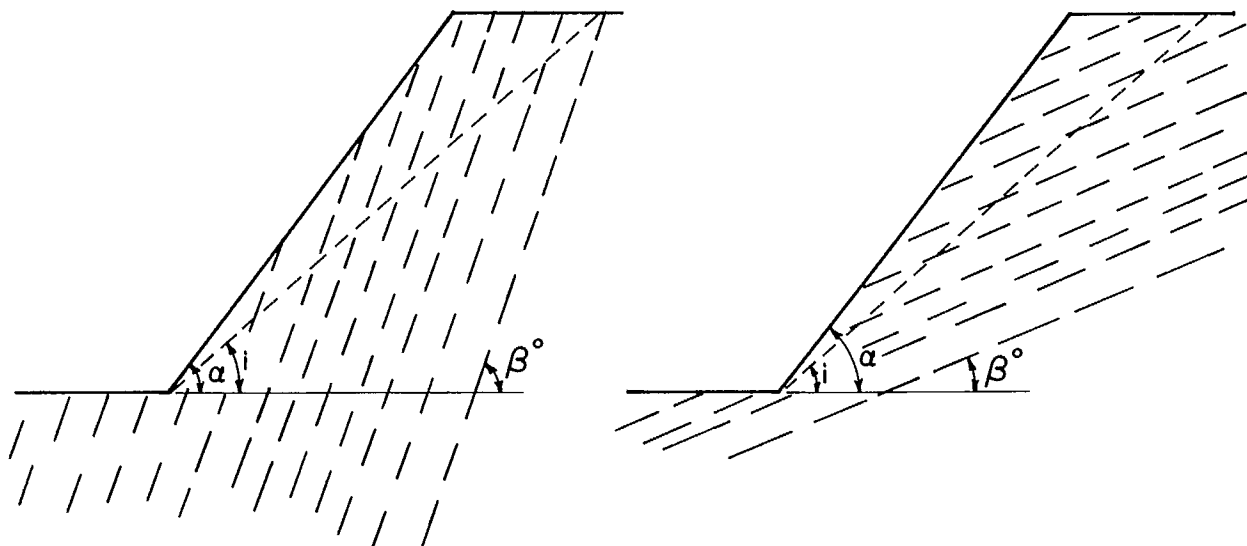

$\beta$  = ANGLE OF DISCONTINUOUS JOINT SYSTEM WITH HORIZONTAL

(a)  $\beta > \alpha$

CALCULATE CABLE LENGTHS, USING  $i^\circ$

(b)  $\beta < \alpha$

CALCULATE CABLE LENGTHS ONLY, BY PUTTING  $\beta = i$

Figure 7. Orientation of discontinuous joint systems affects calculation of cable lengths.

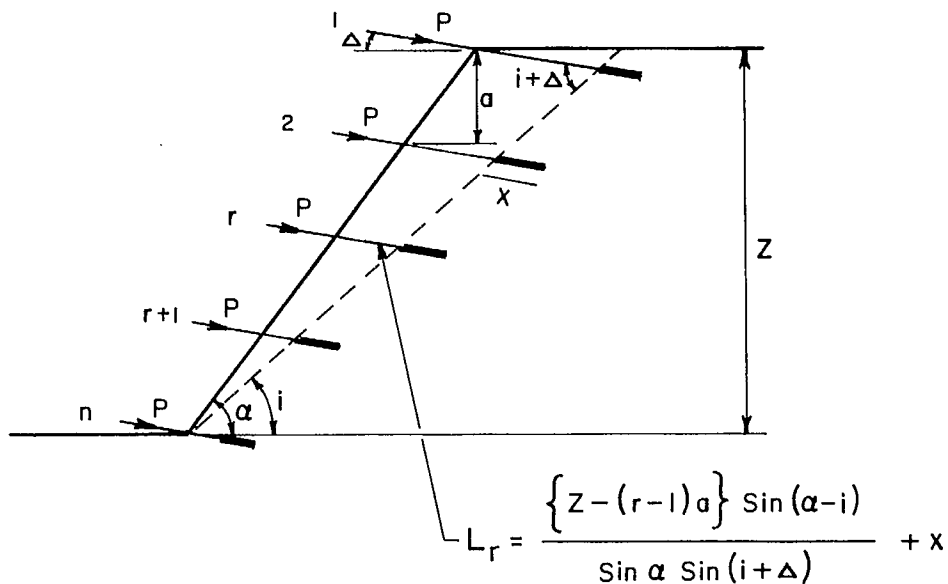

Figure 8. Calculation of cable lengths - cables numbered from crest (1,2,---r, r+1,---n).

If, however,  $\beta < i^{\circ}$  as illustrated in Figure 7b, it is feasible that the incipient failure plane might be the plane through the toe oriented at  $\beta^{\circ}$ . Although this latter plane is not the plane of maximum excess shear stress, it might be a plane of minimum shear strength. In this case it is thought that the cable anchors should be extended beyond the plane at  $\beta^{\circ}$  through the toe. Nevertheless, the cable anchor loads and spacing would still be designed to eliminate the maximum excess shear stress on the plane at  $i^{\circ}$ . Thus, when  $\beta < i^{\circ}$ , the cable lengths are obtained by replacing  $i^{\circ}$  by  $\beta^{\circ}$  in equation 12.

There is, of course, some minimum length of cable which it is practical to install. This minimum length depends mainly on the cable chosen but can, for most cables, be taken as  $(15 + x)$  ft. Where  $x$  is the recommended length for grouted anchorage, this minimum length should always be used when the calculated length given above in equation (12) yields a lower value.

The choice of the actual cable anchors to be used is dependent to a large extent on availability. Table A 1 in Appendix I gives the characteristics of a number of multi-strand tendons which might be suitable. Generally, the largest capacity cable available would be chosen in order to provide maximum restraint for a minimum number of installations. For example, from Table A 1 in Appendix I, a 12-strand type 270K cable might be chosen. This cable has a maximum initial tensioning load of 390,000 lbs; however, it is generally good practice to allow an extra safety factor here and to tension to approximately 15% lower than this value (or as recommended by the manufacturer). Thus the design load  $P$  for this cable could be chosen as 340,000 lbs.

## BENCH STABILITY ANALYSIS

After application of the cable forces, it is assumed that the rock mass contained within the  $90^\circ$  cones about the cables is supported by the cable forces. However, the individual benches are still unsupported. Some support may be given to this unsupported ground by means of welded wire mesh laid over the slope face and tied down by horizontal stringers running between the cable anchor points along the toes of the benches. Ideally these elements should also be designed to resist the load of the rock mass which might fail. The volume of rock which is unsupported by the cable forces is in the wedge LMNO in Figure 9. For design purposes it is assumed that this rock fails through the toe of the bench along a plane at some angle  $\varphi^\circ$  to the horizontal. As before, consider the excess shear forces acting on this plane. Let  $\alpha^\circ$  be the overall pit slope, let  $w$  be the bench width, let  $\Delta$  be the angle of the cables with the horizontal, and let  $\gamma$  be the rock density in lbs/cu ft.

As before (Figure 3), the excess shear force per unit block acting down the slope at angle  $\varphi^\circ$  is given by:

$$f_e = \gamma (\sin \varphi - \mu \cos \varphi) \quad (13)$$

The volume of rock,  $V$ , per unit section thickness is the volume of the wedge MLPN in Figure 9 when  $\varphi < \alpha$ , and is the volume of the wedge LMN in Figure 10 when  $\varphi > \alpha$ . The total excess shear force,  $F_e$ , on the plane at  $\varphi^\circ$ , per unit thickness of section, is given by:

$$F_e = V f_e = \gamma V (\sin \varphi - \mu \cos \varphi) \quad (14)$$

(assuming no cohesion on line LP when  $\varphi < \alpha$ ).



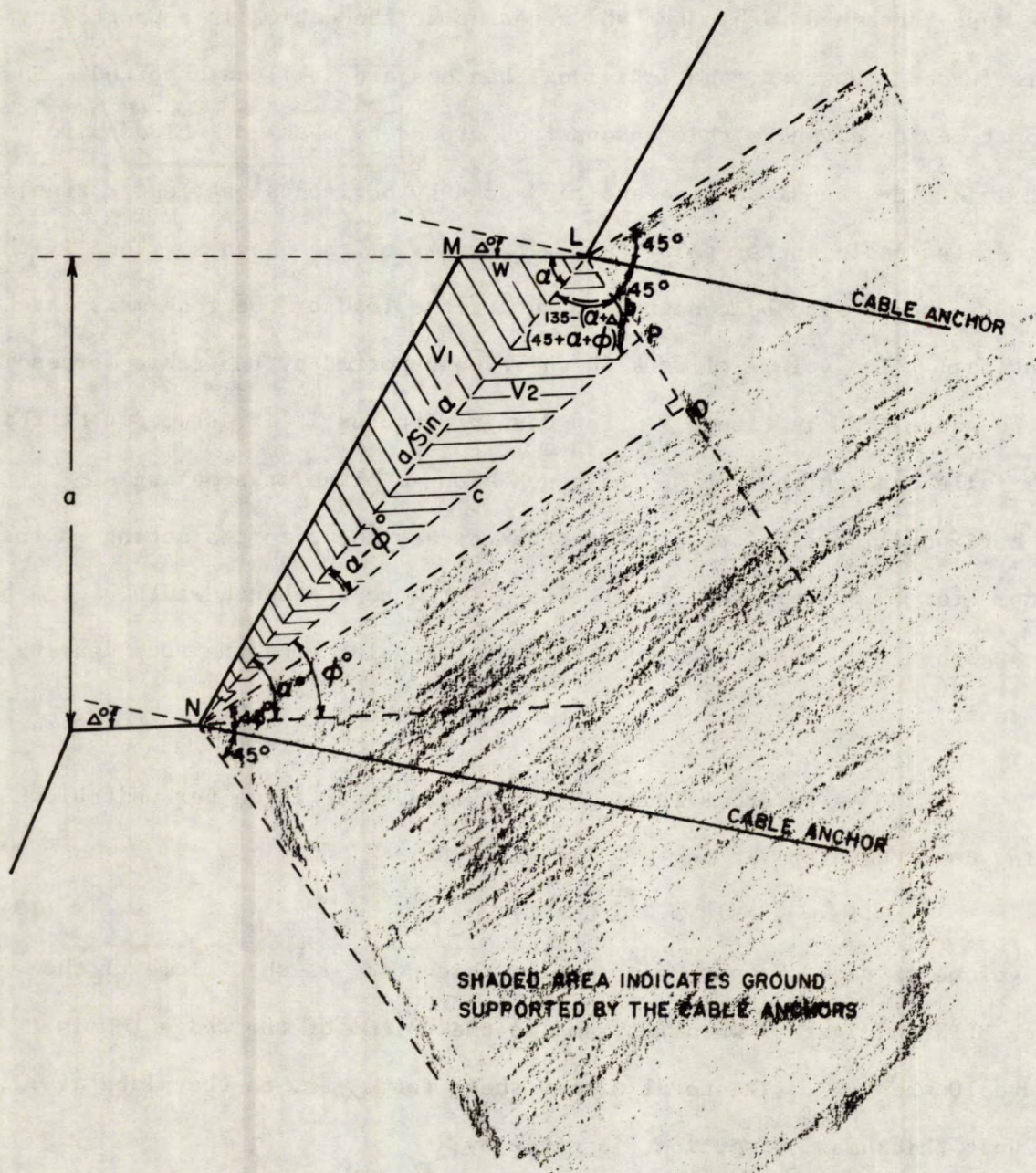
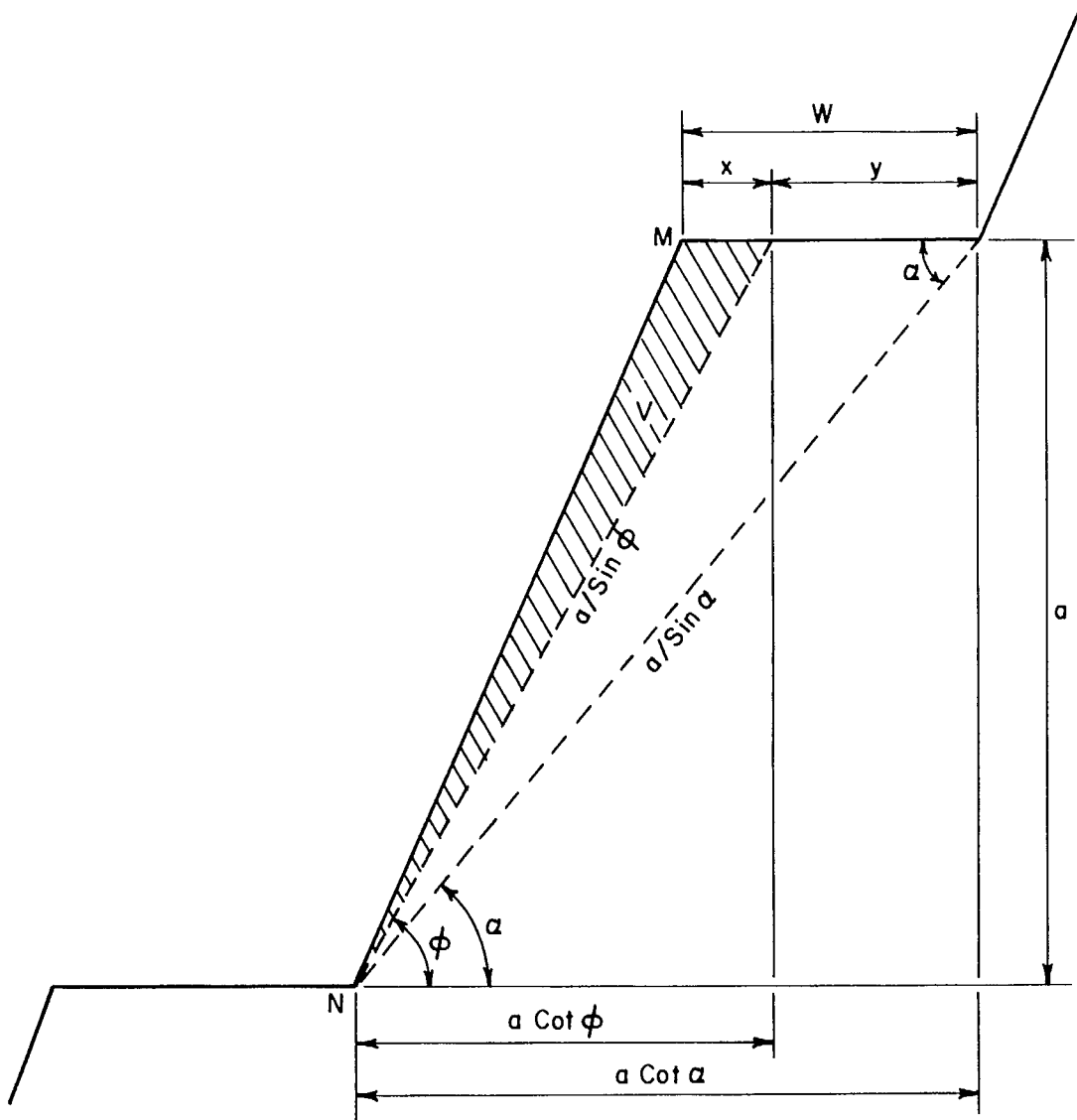

Figure 9. Rock volume involved in bench stability analysis,  $\phi < \alpha$ .





$$V = \frac{1}{2} ax ; \quad x = W - y ; \quad y = (a \cot \alpha - a \cot \phi)$$

$$\text{i.e. } V = \frac{1}{2} a \{ W - a \cot \alpha + a \cot \phi \}$$

Figure 10. Rock volume involved in bench stability analysis,  $\phi > \alpha$ .

(1) when  $\varphi < \alpha$

In this case the volume  $V$  equals  $V_1 + V_2$ , the sum of the wedges NML and NLP in Figure 9. Let  $w$  be the bench width and let  $NP = c$ , then:

$$V_1 = \frac{1}{2} aw \quad (15)$$

$$\text{and} \quad V_2 = \frac{1}{2} \frac{a}{\sin \alpha} \cdot c \cdot \sin (\alpha - \varphi) \quad (16)$$

but, by geometry:

$$\frac{c}{\sin(135 - \alpha - \Delta)} = \frac{a}{\sin \alpha} \cdot \frac{1}{\sin(45 + \alpha + \varphi)}$$

$$\text{i.e.} \quad \frac{\sqrt{2} c}{\{\cos(\alpha + \Delta) + \sin(\alpha + \Delta)\}} = \frac{a}{\sin \alpha} \cdot \frac{\sqrt{2}}{\{\cos(\alpha + \varphi) + \sin(\alpha + \varphi)\}}$$

$$\text{i.e.} \quad c = \frac{a}{\sin \alpha} \frac{\{\cos(\alpha + \Delta) + \sin(\alpha + \Delta)\}}{\{\cos(\alpha + \varphi) + \sin(\alpha + \varphi)\}} \quad (17)$$

Hence, from equations (14), (15), (16) and (17):

$$F_e = \frac{ay}{2} \left\{ w + \left[ \frac{a \sin(\alpha - \varphi)}{\sin^2 \alpha} \frac{\{\cos(\alpha + \Delta) + \sin(\alpha + \Delta)\}}{\{\cos(\alpha + \varphi) + \sin(\alpha + \varphi)\}} \right] \right\} \{\sin \varphi - \mu \cos \varphi\} \quad (18)$$

and the average excess shear stress on this plane,  $\tau_e$ , =  $F_e/c$ , assuming no cohesion on the line LP.

Hence  $\tau_e$  is given by:

$$\tau_e = \frac{ay}{2} \left\{ \frac{w \sin \alpha \{\cos(\alpha + \varphi) + \sin(\alpha + \varphi)\}}{a \{\cos(\alpha + \Delta) + \sin(\alpha + \Delta)\}} + \left[ \frac{\sin(\alpha - \varphi)}{\sin \alpha} \right] \right\} \{\sin \varphi - \mu \cos \varphi\} \quad (19)$$

$$= \{k_1 [\cos(\alpha + \varphi) + \sin(\alpha + \varphi)] + k_2 \sin(\alpha - \varphi)\} \{\sin \varphi - \mu \cos \varphi\} \quad (20)$$

$$\text{where} \quad k_1 = \frac{wy}{2} \frac{\sin \alpha}{\{\cos(\alpha + \Delta) + \sin(\alpha + \Delta)\}} \quad \text{and} \quad k_2 = \frac{ay}{2 \sin \alpha} \quad (21)$$

$\tau_e$  will reach a maximum value at some angle  $\varphi$  when  $\partial \tau_e / \partial \varphi = 0$ . Ideally the support for the benches should be designed to resist this maximum excess shear stress. The value of  $\varphi$  for which  $\tau_e$  reaches a maximum has been determined

in Appendix II and is given by:

$$\tan 2\varphi = \frac{\{k_1(\sin\alpha + \cos\alpha) + \mu k_1(\sin\alpha - \cos\alpha) + k_2(\sin\alpha + \mu\cos\alpha)\}}{\{k_1(\sin\alpha - \cos\alpha) - \mu k_1(\sin\alpha + \cos\alpha) + k_2(\cos\alpha - \mu\sin\alpha)\}} \quad (22)$$

Hence  $\varphi$  may be calculated and, using this value of  $\varphi$ , the maximum excess shear stress can be calculated from equation (20). An example is given in Appendix II.

(ii) when  $\varphi > \alpha$

In this case the volume  $V$  per unit section thickness equals the volume of the wedge LMN in Figure 10. By geometry:

$$V = \frac{1}{2}a \{w - a \cot \alpha + a \cot \varphi\} \quad (23)$$

Hence the excess shear force  $F_e$  is given by:

$$F_e = \gamma V \{\sin \varphi - \mu \cos \varphi\} \quad (14)$$

and the average excess shear stress,  $\tau_e$ , on the plane NL is given by:

$$\tau_e = \frac{\gamma V}{a} \sin \varphi \{\sin \varphi - \mu \cos \varphi\} = \frac{\gamma V}{a} \{\sin^2 \varphi - (\mu/2) \sin 2\varphi\}. \quad (24)$$

Hence, from equations (24) and (23):

$$\begin{aligned} \tau_e &= \frac{\gamma}{2} \left\{ \sin^2 \varphi - \frac{\mu}{2} \sin 2\varphi \right\} \{w - a \cot \alpha + a \cot \varphi\} \\ &= \frac{\gamma}{2} \left\{ \sin^2 \varphi (w - a \cot \alpha) - \frac{\mu}{2} \sin 2\varphi (w - a \cot \alpha) \right. \\ &\quad \left. + \sin^2 \varphi \frac{a \cdot \cos \varphi}{\sin \varphi} - \frac{a \mu}{2} \sin 2\varphi \frac{\cos \varphi}{\sin \varphi} \right\} \\ &= \frac{\gamma}{2} \left\{ \sin^2 \varphi (w - a \cot \alpha) - \sin 2\varphi \left\{ \frac{\mu w}{2} - \frac{a \mu \cot \alpha}{2} - \frac{a}{2} \right\} - a \mu (1 - \sin^2 \varphi) \right\} \\ &= \frac{\gamma}{2} \left\{ \sin^2 \varphi (w - a \cot \alpha + a \mu) - \sin 2\varphi \left\{ \frac{\mu w}{2} - \frac{a \mu}{2} \cot \alpha - \frac{a}{2} \right\} - a \mu \right\}. \quad (25) \end{aligned}$$

$\tau_e$  will reach a maximum at some angle  $\varphi$  when  $\partial \tau_e / \partial \varphi = 0$ :

$$\frac{\partial \tau_e}{\partial \varphi} = \frac{Y}{2} \left\{ 2 \sin \varphi \cos \varphi (w - a \cot \alpha + a\mu) - 2 \cos 2\varphi \left\{ \frac{\mu w}{2} - \frac{\mu a}{2} \cot \alpha - \frac{a}{2} \right\} \right\};$$

put  $\partial \tau_e / \partial \varphi = 0$  and solve for  $\varphi$  for maximum value of  $\tau_e$ :

$$\sin 2\varphi \{w - a \cot \alpha + a\mu\} = \cos 2\varphi \left\{ \frac{\mu w}{2} - \frac{\mu a}{2} \cot \alpha - \frac{a}{2} \right\}$$

$$\text{i.e. } \tan 2\varphi = \frac{\{\mu w - a\mu \cot \alpha - a\}}{\{w - a \cot \alpha + a\mu\}}. \quad (26)$$

This equation defines the angle  $\varphi$  at which  $\tau_e$  reaches a maximum when  $\varphi > \alpha$ .

#### DESIGN OF THE WELDED WIRE MESH

Assume that the wire mesh is laid over the bench and tied into the toe of each bench as illustrated in Figure 11. Assume that, if failure occurs, a tension  $T$  is produced in the longitudinal strands of the mesh, and assume that these tension forces act at the toe of each bench in the direction of the deep cable anchors to which the mesh is attached.

The total resisting force which can be mobilized by the mesh, per unit section thickness, is given by:

$$R_F = 2 T \{ \cos (\varphi + \Delta) + \mu \sin (\varphi + \Delta) \}$$

Thus the average resisting shear stress,  $\tau_F$ , mobilized by the mesh is given by:

(i) when  $\varphi < \alpha$

$$\tau_F = \frac{R_F}{c} = \frac{2T \{ \cos (\varphi + \Delta) + \mu \sin (\varphi + \Delta) \} \cdot \sin \alpha \{ \cos (\alpha + \varphi) + \sin (\alpha + \varphi) \}}{a \{ \cos (\alpha + \Delta) + \sin (\alpha + \Delta) \}} \quad (27)$$

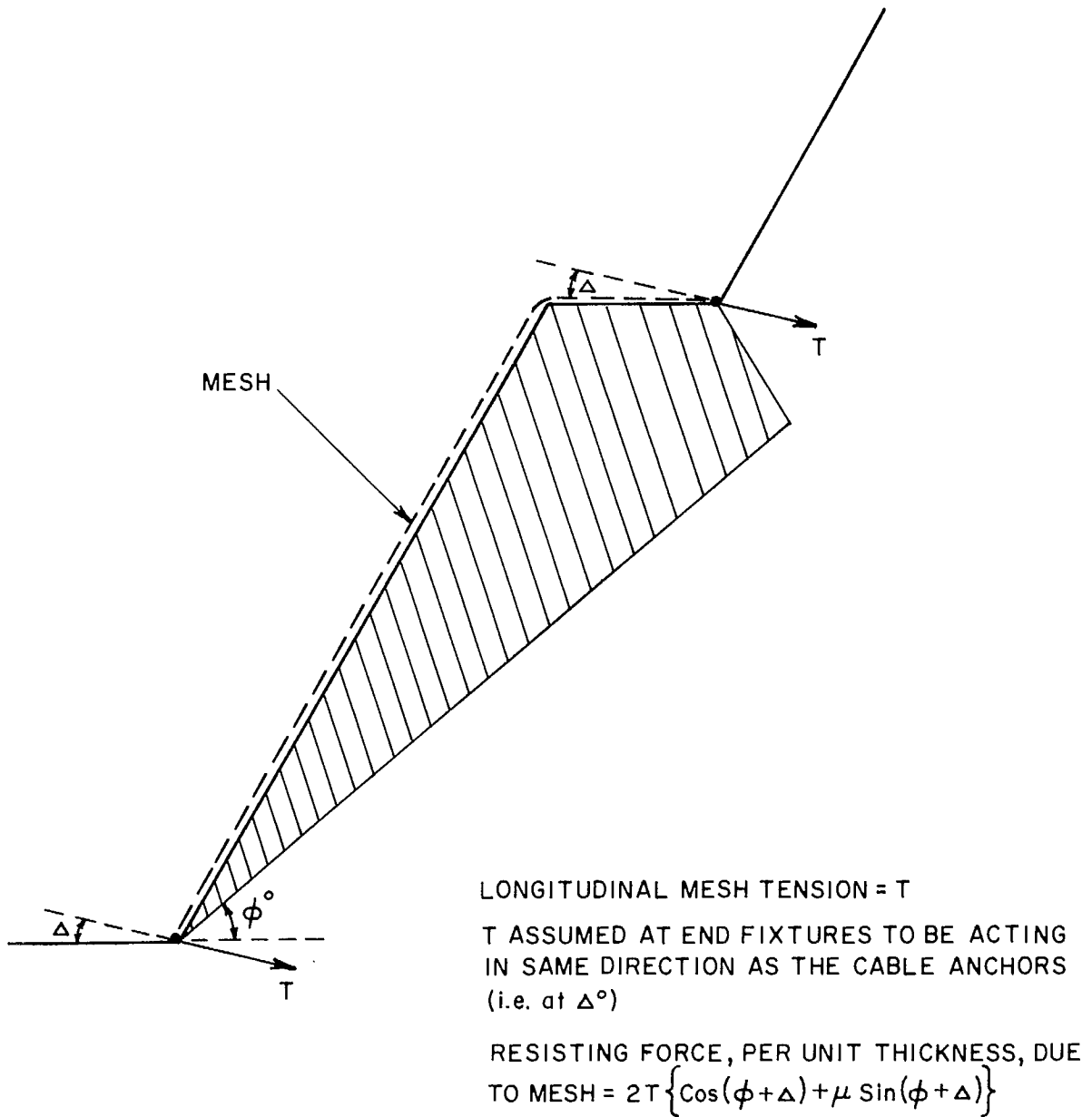

Figure 11. Assumed action lines of mesh forces.

(ii) when  $\varphi > \alpha$

$$\tau_F = \frac{R_F}{a} \sin \varphi = \frac{2T \{ \cos (\varphi + \Delta) + \mu \sin (\varphi + \Delta) \} \sin \varphi}{a} \quad (28)$$

Thus for a safety factor of unity the shear resistance that can be mobilized by the mesh should be equal to the maximum excess shear stress  $\tau_e$ . Hence:

(i) when  $\varphi < \alpha$   $\tau_e = \tau_F$ , which from equations (20) and (27) gives:

$$\begin{aligned} \frac{a\gamma}{2} \left\{ \frac{w \sin \alpha [\cos (\alpha + \varphi) + \sin (\alpha + \varphi)]}{a [\cos (\alpha + \Delta) + \sin (\alpha + \Delta)]} + \frac{\sin (\alpha - \varphi)}{\sin \alpha} \right\} (\sin \varphi - \mu \cos \varphi) \\ = \frac{2T}{a} \frac{\sin \alpha \{ \cos (\varphi + \Delta) + \mu \sin (\varphi + \Delta) \} \{ \cos (\alpha + \varphi) + \sin (\alpha + \varphi) \}}{[\cos (\alpha + \Delta) + \sin (\alpha + \Delta)]} \end{aligned}$$

Hence the cable tension is given by:

$$T = \frac{a\gamma}{4} \frac{(\sin \varphi - \mu \cos \varphi)}{[\cos (\varphi + \Delta) + \mu \sin (\varphi + \Delta)]} \left[ w + \frac{a \sin (\alpha - \varphi) \{ \cos (\alpha + \Delta) + \sin (\alpha + \Delta) \}}{\sin^2 \alpha [\cos (\alpha + \varphi) + \sin (\alpha + \varphi)]} \right] \quad (29)$$

Hence, if  $A_o$  is the area of steel required within the longitudinal strands of the mesh and  $\sigma_o$  is the yield strength of the cold-drawn mesh material, then:

$$A_o = \frac{T}{\sigma_o} \quad (30)$$

i.e. from equations (29) and (30):

$$A_o = \frac{a\gamma}{4\sigma_o} \frac{(\sin \varphi - \mu \cos \varphi)}{[\cos (\varphi + \Delta) + \mu \sin (\varphi + \Delta)]} \left[ w + \frac{a \sin (\alpha - \varphi) \{ \cos (\alpha + \Delta) + \sin (\alpha + \Delta) \}}{\sin^2 \alpha [\cos (\alpha + \varphi) + \sin (\alpha + \varphi)]} \right] \quad (31)$$

For design purposes the lateral strands of the mesh are not assumed to contribute to the strength.

(ii) when  $\varphi > \alpha$   $\tau_e = \tau_F$ , which from equations (25) and (28) gives:

$$\begin{aligned} \frac{\gamma}{2} \left\{ \sin^2 \varphi (w - a \cot \alpha + a\mu) - \sin 2\varphi \left( \frac{\mu w}{2} - \frac{a\mu}{2} \cot \alpha - \frac{a}{2} \right) - a\mu \right\} \\ = \frac{2T \{ \cos (\varphi + \Delta) + \mu \sin (\varphi + \Delta) \} \sin \varphi}{a} \end{aligned}$$

Hence the cable tension is given by:

$$T = \frac{\gamma}{2} a \frac{\{\sin^2 \omega (w - a \cot \alpha + \mu) - \sin 2\varphi \left( \frac{\mu w}{2} - \frac{a\mu}{2} \cot \alpha - \frac{a}{2} \right) - a\mu\}}{\{\cos (\varphi + \Delta) + \mu \sin (\varphi + \Delta)\} \sin \varphi} \quad (32)$$

and from equations (30) and (32), the area of steel  $A_o$  is given by:

$$A_o = \frac{\gamma a}{2\sigma_o} \frac{\{\sin^2 \omega (w - a \cot \alpha + \mu) - \sin 2\varphi \left( \frac{\mu w}{2} - \frac{a\mu}{2} \cot \alpha - \frac{a}{2} \right) - a\mu\}}{\{\cos (\varphi + \Delta) + \mu \sin (\varphi + \Delta)\} \sin \varphi} \quad (33)$$

Again, the lateral strands of the mesh are not assumed to contribute to the strength.

Example: Suppose  $\alpha = 50^\circ$ ,  $a = 66$  ft,  $w = 40$  ft,  $\Delta = -10^\circ$ ,  $\mu = 0.8$ ,  $\gamma = 165$  lbs/cu ft, and  $\sigma_o$  for cold-drawn steel is 71,000 lbs/sq in. The angle  $\varphi$  at which the excess shear stress in the bench reaches a maximum must be determined from either equation (22) or equation (26). For this example it was shown in Appendix II that, using equation (22),  $\varphi = 48^\circ 48'$  which is  $< \alpha^\circ$ . Hence, using equation (31) for the case  $\varphi < \alpha$ , the area of steel mesh per unit thickness required is given by:

$$A_o = \frac{66 \times 165}{4 \times 71,000} \left\{ \frac{\{\sin 48^\circ 48' - 0.8 \cos 48^\circ 48'\}}{\{\cos 38^\circ 48' - 0.8 \sin 38^\circ 48'\}} \right\} 40 + \frac{66 \sin 1^\circ 12' \{\cos 40 + \sin 40\}}{\sin^2 50 \{\cos 98^\circ 48' + \sin 98^\circ 48'\}} \left\{ \right.$$

$$= 0.298 \approx 0.30 \text{ sq inch per foot thickness of section.}$$

In Appendix III, Table A3.1 gives a list of some standard styles of welded wire meshes, Table A3.2 gives weight of this welded wire fabric, and Table A3.3 gives the areas of cross section of welded wire fabric. In this example, referring to Table A3.1, a mesh style 216-28 having a longitudinal section area of 0.325 sq inch would be adequate. This mesh has 6 longitudinal strands of No. 2 wire (0.2625 in. diameter) per foot, and transverse wires, spaced 16 inches apart, of No. 16 wire (0.062-in. diameter). The mesh weighs



119.4 lbs per 100 sq ft. If a choice of styles is available it would be best to select the lightest mesh with adequate longitudinal strength. Whilst the above mesh is theoretically adequate to support the bench, it is exceedingly heavy and a number of problems might be experienced in installing such a heavy mesh in the field.

In other examples it is quite possible that the area of steel required from the above calculation may be so large that a suitable mesh is not available (even assuming it may be easily installed). It may not, therefore, be possible to provide complete bench support, either because a sufficiently strong mesh is unavailable or because it is too heavy to install. Nevertheless, the installation of such mesh is still recommended, even if not of full required strength, for the following reasons:

- (a) The ideal design is based on a "worst case" failure plane.
- (b) It was assumed that the bench would fail along its complete length. In most open-pit mines this would be an unusual occurrence; partial bench failure is much more likely. This, of course, varies both from mine to mine and from one wall section to another within any one mine.
- (c) The lateral strands will add some strength to the mesh.
- (d) Even partial support given by a light-weight mesh would give a better control than exists at present, where bench failure is often tolerated as a matter of course. The mesh would at least assist in protection from loose falling rock.

The above analyses should therefore be viewed, not as absolute design criteria, but as a method of estimating a maximum idealized mesh size which might assist in the engineering judgement required in selecting the actual mesh to be used in a particular area of the mine. It

is probable that in many cases the mesh actually selected will not provide complete bench support and, indeed, as will be seen below, even if the mesh itself were sufficiently strong it is unlikely that the horizontal stringers supporting the mesh would be able to withstand the resultant load.

#### DESIGN OF THE HORIZONTAL STRINGERS

The horizontal stringers are required in order to hold the mesh in place along the entire span,  $l$ , between the cable anchors. The mesh load can be considered as a uniformly distributed load acting on this horizontal beam.

The maximum bending moment at the centre of the span is given approximately by: (5)

$$M = \frac{Tl^2}{10}, \quad (34)$$

where  $T$  = the load per foot acting on the beam (i.e.  $T$  = the mesh tension given by either equation (29) or (32), if the mesh were designed to resist all the bench failure force).

If the horizontal stringer is a reinforced concrete beam, then this beam can be designed by the standard techniques to resist the maximum flexural bending moment (5). These design techniques will not be dealt with in detail here since they are included in many text books (5). To illustrate the method, assume that a convenient size of concrete beam is 18 in. x 18 in., assume that the ultimate compressive strength of the concrete  $f'_c = 2,500$  psi, and assume that the minimum yield strength of the steel reinforcing bars is  $f'_s = 33,000$  psi. The area of reinforcing steel required in the concrete beam

is given by:

$$A_s = \frac{M}{f'_s j d} \quad (35)$$

where  $M$  = the bending moment;  $j$  = ratio arm of the resisting couple to the effective depth (5) (for approximate design purposes  $j$  can be taken as  $7/8$ ); and  $d$  is the distance from the compression face of the beam to the plane of the centroid of the tensile steel, or the "effective depth" [for an 18-inch beam and steel bars set  $1\frac{1}{2}$  inches from the tension surface,  $d = 16.5$  inches].

For example, to support the complete bench given in the preceding example it was found that the area of mesh required was 0.3 sq inch. Thus, from equation (30), the mesh tension  $T$  = the load on the beam per foot and is given by:

$$T = \sigma_o A_o = 0.3 \times 71,000 = 21,300 \text{ lbs/ft.}$$

Hence, from equation (34), assuming that the span  $l = 40$  ft, the maximum bending moment  $M$  is given by:

$$M = \frac{Tl^2}{10} = \frac{21,300 \times 40 \times 40 \times 12}{10} = 41 \times 10^6 \text{ in lbs.}$$

Hence the area of steel required in the beam is given by equation (35) as:

$$A_s = \frac{41 \times 10^6}{33,000 \times 7/8 \times 16.5} = 86 \text{ sq inches.}$$

Appendix IV gives the areas of various steel bars. This case would thus require 86 of No. 9 steel bars. This is obviously completely impractical. It is seen, therefore, that in many cases it will not be possible to design a system for complete bench support.

What is probably more practical is to select a suitable beam design and to estimate the safety factor of the bench support actually

provided:

Choose the beam dimensions and the quantity of steel; then from equation (35) the bending moment is given by:

$$M = A_s f'_s j d \quad (36)$$

Using this value of M, the load per unit length of the beam, T, can be calculated from equation (34):

$$T = \frac{10M}{l^2} = \frac{10A_s f'_s j d}{l^2} \quad (37)$$

Hence, from equation (3), the area of mesh required to support this beam load can be calculated and thus the compatible mesh can be selected:

$$A_o = \frac{T}{\sigma_o} = \frac{10A_s f'_s j d}{\sigma_o l^2} \quad (38)$$

Now the safety factor of the bench,  $S_{FB}$ , can be defined as the ratio of the mobilized resisting stress,  $\tau_F$ , to the excess shear stress on the plane at  $\varphi^o$ . Hence:

when  $\varphi < \alpha$ , from equations (20), (21) and (27):

$$\begin{aligned} S_{FB} &= \frac{\tau_F}{\tau_e} = \frac{2T\{\cos(\varphi+\Delta) + \mu \sin(\varphi+\Delta)\} \sin \alpha \{\cos(\alpha+\varphi) + \sin(\alpha+\varphi)\}}{a\{\cos(\alpha+\Delta) + \sin(\alpha+\Delta)\} \left[ \frac{w\gamma}{2} \frac{\sin \alpha}{\{\cos(\alpha+\Delta) + \sin(\alpha+\Delta)\}} + \frac{a\gamma}{2\sin \alpha} \sin(\alpha-\varphi) \right] (\sin \varphi - \mu \cos \varphi)} \\ &= \frac{2T \sin^2 \alpha \{\cos(\varphi+\Delta) + \mu \sin(\varphi+\Delta)\} \{\cos(\alpha+\varphi) + \sin(\alpha+\varphi)\} \{\cos(\alpha+\Delta) + \sin(\alpha+\Delta)\}}{[a w \gamma \sin^2 \alpha + a^2 \gamma \sin(\alpha-\varphi) \{\cos(\alpha+\Delta) + \sin(\alpha+\Delta)\}] [\sin \varphi - \mu \cos \varphi]} \end{aligned}$$

and substituting from equation (38) for T gives:

$$S_{FB} = \frac{20A_s f'_s j d \sin^2 \alpha \{\cos(\varphi+\Delta) + \mu \sin(\varphi+\Delta)\} \{\cos(\alpha+\varphi) + \sin(\alpha+\varphi)\} \{\cos(\alpha+\Delta) + \sin(\alpha+\Delta)\}}{a l^2 \gamma [w \sin^2 \alpha + a \sin(\alpha-\varphi) \{\cos(\alpha+\Delta) + \sin(\alpha+\Delta)\}] [\sin \varphi - \mu \cos \varphi]} \quad (39)$$

Similarly when  $\varphi > \alpha$ , from equations 25 and 28:

$$S_{FB} = \frac{\tau F}{\tau_e} = \frac{2T \{ \cos(\varphi + \Delta) + \mu \sin(\varphi + \Delta) \} \sin \varphi}{a \frac{\gamma}{2} \{ \sin^2 \varphi (w - a \cot \alpha + a\mu) - \sin 2\varphi \left\{ \frac{\mu w}{2} - \frac{a\mu}{2} \cot \alpha - \frac{a}{2} \right\} - a\mu \}}$$

$$= \frac{4T \{ \cos(\varphi + \Delta) + \mu \sin(\varphi + \Delta) \}}{a \gamma \{ \sin \varphi (w - a \cot \alpha + a\mu) - \cos \varphi (\mu w - a\mu \cot \alpha - a) - a\mu \operatorname{cosec} \varphi \}}$$

and substituting from equation (38) gives:

$$S_{FB} = \frac{40 A_s f'_s j d \{ \cos(\varphi + \Delta) + \mu \sin(\varphi + \Delta) \}}{a \gamma l^2 \{ \sin \varphi (w - a \cot \alpha + a\mu) - \cos \varphi (\mu w - a\mu \cot \alpha - a) - a\mu \operatorname{cosec} \varphi \}} \quad (40)$$

For example: Consider the previous example; say that it is practical to insert an area of 10 sq inches of reinforcing steel in the beam (comprising 8 of No. 10 bars). Let the beam be 18 in. x 18 in., let  $d = 16.5$  in., and assume  $j = 7/8$ ,  $f'_s = 33,000$  psi,  $\sigma_o = 71,000$  psi. Assume  $\alpha = 50^\circ$ ,  $a = 66$  ft,  $w = 10$  ft,  $\Delta = -10^\circ$ ,  $l = 40$  ft,  $\mu = 0.8$  and  $\gamma = 165$  lbs/cu ft. In this case, as shown previously,  $\varphi = 48^\circ 48'$ .

Then, from equation (38), the area of mesh steel required is given by:

$$A_o = \frac{10 A_s f'_s j d}{\sigma_o l^2} = \frac{10 \cdot 10 \cdot 33,000 \times 7 \times 16.5}{71,000 \times 8 \times 40 \times 40 \times 12} = 0.035 \text{ sq in.},$$

i.e. from Appendix III, either mesh style 33-1212 or mesh style 66-99 is suitable since they have area of 0.035 sq inch. However, mesh 33-1212 is lighter (24.74 lbs/100 sq ft) than 66-99 mesh (25.03 lbs/100 sq ft); thus the 33-1212 mesh would be selected. This mesh is not strong enough to support the complete bench; the safety factor is given by equation (39) since  $\varphi < \alpha$ :

$$S_{FB} = \frac{20 \cdot 10 \cdot 33,000 \cdot 7/8 \cdot 16.5 \sin^2 50 \{ \cos(38^\circ 48') + 0.8 \sin(38^\circ 48') \}}{66 \times 40 \times 40 \times 12 \times 165 \{ 40 \sin^2 50 + 66 \sin 10^\circ 12' [\cos 40 + \sin 40] \}} \times$$

$$\frac{\{ \cos 98^\circ 48' + \sin 98^\circ 48' \} \{ \cos 40 + \sin 40 \}}{\{ \sin 48^\circ 48' - 8 \cos 48^\circ 48' \}}$$

$$= 0.07$$

In this example, the bench stability safety factor introduced by the mesh support is low and the bench cannot be regarded as completely supported. However, the mesh will enable some control to be exercised on the fall of loose pieces of rock. In other examples this factor might be considerably higher; since the limiting factor of this support is the maximum bending moment that the beam can tolerate, then obviously the span  $l$  of the beam between the cable anchors has a large influence on the bench stability safety factor. The shorter is this span the greater will be this safety factor (i.e., the horizontal stringer will be more rigid). This span  $l$  is, however, decided on the basis of the slope stability analysis and not from the bench stability analysis. It is very doubtful that it would be economic to reduce this span below the maximum allowed by the slope stability analysis, since this would increase considerably the amount of drilling required for insertion of cable anchors.

#### CONCLUSION

It must be emphasised that the preceding analyses can on no account be regarded as design criteria. Numerous assumptions have been involved in the analyses, the validity of which are in some cases dubious. At the most, these analyses can only be regarded as establishing guide lines for design which might assist engineering judgement. Nevertheless, it is thought that this approach does illustrate the practicability of using deep cable anchors as a method of slope support which could be used to allow steepening of existing slopes in relatively competent hard rocks. In addition, although the analysis shows that complete bench support is probably unobtainable, the use of wire mesh does offer a small degree of bench support which must in general be some improvement on current practice. The mesh does give a pro-

tection to men and machinery against small, but nonetheless hazardous, rock falls. The next section of this report therefore describes a trial installation of such a support system.

PART II: A TRIAL INSTALLATION OF A SLOPE SUPPORT SYSTEM

INTRODUCTION

In order to obtain experience in the construction techniques and to refine costs estimates on the basis of actual construction experience, a trial installation of a support system was planned (6). In addition, the trial installation was to be instrumented to monitor the behaviour of both the supports and the supported rock mass.

The primary objectives of this trial installation were defined as follows:

- (i) To examine difficulties which might be experienced in installation of a support system.
- (ii) To evaluate different construction techniques.
- (iii) To determine construction costs upon which a more accurate estimate of a major support system could be based.
- (iv) To instrument the supports and the rock slope to assess the effectiveness of the support system.



## PLANS FOR THE INSTALLATION

This trial support system was designed so that a maximum return of knowledge of the difficulties that might occur in its installation and of the costs could be obtained. As a consequence of this, where two alternative methods of construction might equally well be used both methods have been tried in different areas of the system.

The trial support system was designed to cover a 50-ft-wide section of a typical bench, which is 68 ft high. The main support is provided by four tensioned cable anchors installed at an angle  $10^{\circ}$  below the horizontal. Two of these are installed at the top of the bench and two below, both pairs being spaced 50 ft apart. Each pair of cable anchors is connected together with horizontal stringers, and mesh is laid to cover the whole bench.

(a) The bench is covered with Style 66-44 welded steel fabric mesh having individual wires, 0.225 in. diameter, spaced 6 in. apart in both directions. The manufactured width of the mesh rolls is 5 ft. To obtain continuous horizontal wires, the meshes are overlapped at the sides and bound together with No. 9 wire. At the top and at the toe the mesh is connected to the horizontal stringers.

(b) Two different types of horizontal stringers were used. At the toe of the bench the horizontal stringer is made of a cast-in-situ reinforced concrete beam. This beam is nominally 16 in. square and contains six No. 10 reinforcing bars, three at the front and three at the back. The mesh is extended about 5 ft beyond the beam and is embedded in the concrete. The reinforcing bars are extended into and cased within the concrete cable anchor pads. On

the upper bench the horizontal stringer comprises five No. 11 bars only, which are cased into the concrete cable anchor pads at each end. The mesh passes beneath these bars and is wired to them with No. 9 wire.

(c) The cable anchor pads were made from reinforced concrete, the bearing plates and reinforcing being selected as recommended by the manufacturers for use with 270K Freysinnet 12-strand cables (7). To measure the applied cable force and its changes with time, a load cell was installed at each cable anchor pad. The cable passes through the hollow-bodied load cell which is located between the cable anchor pad and the Freysinnet locking cone for the cable.

(d) The cable chosen for the deep anchors was a 12-strand (0.5-in. dia. per strand) 270K cable (see Appendix I). Two holes sizes were chosen for installing the cables; the smallest size was NX casing (3.5-in. dia.) and the largest was HX (3.89 in.). These two sizes were chosen to investigate whether or not it was easier to install the cables in the large holes or whether the smaller size was adequate. The four deep anchors were each of different lengths in order to assess the degree of difficulty in installing in various length holes. The shortest cable was 33 ft; this was about the minimum length suitable for any installations, allowing about 20 ft for the grouted anchorage and 13 ft of free cable. The longest cable chosen was 195 ft, which is the maximum that would be required in a support system for an open pit of 800-ft depth. The third cable was chosen to be 110 ft long.

The fourth length chosen was 55 ft. In this case, however, a Freysinnet cable was not used. Instead, a solid "stressteel bar" (8), 1 3/8 in. diameter, was used as the anchor. This alternate type of anchor does not have

the same capacity as the cable anchors but does offer some advantages with respect to assembly and ease of installation. Appendix V lists the design properties of these bars.

The two shorter anchors were deliberately placed on the same side of the trial section. Thus, if movement should occur, it might be expected to be greater on this side than on the other, thus offering a possible means of assessing the relative effectiveness of anchor length. All the anchors were grouted for the bottom 20 ft of the length.

#### INSTRUMENTATION

It was decided to make the following measurements:

- (a) The cable tension would be monitored. This should give information as to the effectiveness of the grout anchorage. In addition, should ground movement occur, it should result in an increase of cable tension.
- (b) Borehole extensometers were used to monitor the ground movement with time.
- (c) Since the operation of tensioning the cable against the concrete anchor pads is, in effect, a plate load test, it was decided to measure the surface displacement of the ground around the pads during several cycles of loading on each pad prior to final tensioning of the anchor. From these plate load tests it should be possible to determine an in-situ modulus for the surface rock.
- (d) Strain gauges were installed in the concrete forming the lower horizontal stringer. In the event of movement occurring, these measurements would enable the support given by this horizontal stringer to be assessed.
- (e) Core from the cable anchor holes and the extensometer holes was examined to be sure that the cables were anchored in solid ground and to determine

whether any major geological discontinuities were present in the supported ground. In addition, it was decided to examine the interior of the cable anchor holes with a television camera.

(i) A 500,000-lb-capacity load cell was required for measurement of the cable tensions. Since no suitable hollow-bodied load cell of this capacity was commercially available, a cell was specially designed for this purpose. These cells were able to discriminate load changes of approximately  $\pm 300$  lbs and had an overall accuracy of approximately  $\pm 3000$  lbs ( $\pm 6\%$  full capacity). Appendix VI gives a brief description of these load cells.

(ii) Mines Branch vibrating wire extensometers, which can be used with up to four wires in any one borehole, were selected for measuring the ground displacement with time. A PC101 vibrating-wire comparator was used to read these instruments. Appendix VII gives the sensitivities of the instruments used.

(iii) Commercially available vibrating-wire concrete strain gauges, type PC658, were chosen for embedment in the concrete stringer.

(iv) Examination of the inside of the cable anchor holes was carried out with a television camera developed by the Hydro-Electric Power Commission of Ontario. It was suitable for insertion into NX, or larger, holes. This work was carried out by HEPCO on contract and under supervision of Mining Research Centre personnel.

#### CONSTRUCTION SEQUENCE

The following lists the sequence of operations carried out in this trial support installation; Appendix VIII gives a photographic record of these operations:

1. A section of pit wall, 50 ft long and extending from one bench to another

over a height of 66 ft, was cleaned and scaled in preparation for the project.

2. A contractor was brought in to diamond-drill the holes for the four cable anchors and for the wire extensometers.
3. A panel of welded wire mesh was assembled which would cover the 50-ft width from the toe of the upper bench to the toe of the lower bench. This panel was assembled from 5-ft widths of mesh, overlapped and wired together to make up a single unit over the whole area. This panel was then rolled up and placed on the upper bench of the site. It was fastened at the top in the desired position by short rock bolts and was then rolled over the bank so that it lay in the desired location for the installation.
4. The cable anchors and the rod were assembled on site and installed into four holes, two on the upper bench and two on the lower bench. These were grouted at their lower end by 20 ft of portland cement grout.
5. Forming and reinforcing steel were constructed at the head of each anchor to provide a concrete abutment for a bearing plate against which the anchors could be stressed. This concrete formwork also joined the anchor abutments on the lower bench to enable the horizontal stringer to be cased.
6. On the upper bench, the horizontal stringer was constructed of five steel rods passing over the 50-ft test width and through the concrete abutments which provide the anchorage for these rods. The steel mesh was wired to these steel rods along the whole width of the bench section.
7. On the lower bench, the wire mesh passed under the formwork for the horizontal stringer so that when the concrete was poured the mesh would be anchored in the horizontal stringer.

8. Concrete was then poured for the abutments and the horizontal stringer. This was allowed to cure for 28 days.
9. After the concrete had cured, the four anchors were stressed by means of a hydraulic jack to the required load, and the cable ends were locked in position.
10. The cable support system was then allowed to stand for a period of 9 months, during which its behaviour was monitored by the instruments. At the end of this period the cables were slackened, the load cells were retrieved, and the cables were retensioned. Finally, each of the cables was grouted with portland cement grout over its full length to protect the strands against corrosion.

#### CRITIQUE ON CONSTRUCTION EXPERIENCE AND ITEM COSTS

##### Site Preparation

Normal scaling and cleanup were carried out in the area before commencement of the other activities. It was thought that the work done here would be satisfactory for a major support system and that therefore no extra cost, i.e., over and above normal practice, would be incurred.

##### Anchor Holes

Two sizes of cable anchor holes were diamond-drilled; HX size (3.89 in. diameter) and NX casing (3.5 in. diameter). The 196-ft and 33-ft holes were drilled HX size, whilst the 55-ft and 110-ft holes were NX casing size. This drilling was contracted on a footage-plus-diamond cost basis. Costs were as follows:

HX 3.89-inch-diameter holes

|   |                                   |
|---|-----------------------------------|
| Footage drilled (1 hole 196 ft and 1 holes 33 ft) | 229 ft                            |
| Drilling cost                                     | \$9.32/ft                         |
| Travelling, core bores, etc.                      | <u>\$1.65/ft</u>                  |
| Total cost  | \$10.97/ft                        |
| Drilling rate                                     | <u>3.42 ft/operating<br/>hour</u> |

NX Casing 3.5-inch-diameter holes

|  |                                   |
|--|-----------------------------------|
| Footage drilled (1 hole 112 ft and 1 hole 55 ft) | 167 ft                            |
| Drilling cost                                    | \$9.55/ft                         |
| Travelling, core bores, etc.                     | <u>\$1.65/ft</u>                  |
| Total cost                                       | \$11.20/ft                        |
| Drilling rate                                    | <u>2.39 ft/operating<br/>hour</u> |

No serious difficulties were encountered during the drilling of the four anchor holes. The better efficiency was obtained by the drilling contractor on the larger-size holes (HX) because of the availability of the proper type of bits and core barrel. With the 3.5-in. (NX casing) size, core recovery and bit life were poor because standard coring bits and corebarrel were not available and were not worth obtaining for such a small footage. On a major programme, standard NX casing equipment would be available; thus a better efficiency would be expected and the drilling costs per foot would be expected to drop below that for the HX-size holes.

These holes were diamond-drilled so that a good wall would be attained for viewing with the television camera. However, on a major programme this television viewing is unlikely to be carried out; in which case an evaluation of the costs of drilling these anchor holes by a percussion drill would be useful. It is thought that, for certain types of rocks and for relatively short holes, this could be an acceptable and efficient alternative to diamond drilling.

#### Welded Wire Mesh

A panel of welded wire mesh 55½ ft wide was installed over the test area, extending from the lower beam to the upper beam. It was fastened to these beams so that the mesh would prevent chunks of loose rock from falling down the slope and would give support to a portion of the berm in the event of its failure.

Twelve 5-foot widths of 66-44 welded wire mesh were cut into lengths which would extend from above the upper stringer, across the berm, and down the bank to just below the lower stringer. These lengths of mesh were overlapped by six inches and were wired together with No. 9 annealed galvanized wire. The wiring of the mesh was conducted in a level area away from the test site. After the wiring was complete, the panel of mesh was rolled up and transported to the upper bench of the test site, using a front-end loader. There it was positioned, using a crane, and fastened to the rock with two short bolts. It was then rolled across the berm and over the bank. This procedure placed the mesh in its desired position for the system.

The most effort required concerning the mesh was the wiring together of the lengths of mesh. It was found that a patented wire-twisting



device, commercially available, was slow and cumbersome to use. As a result a new procedure was devised: The annealed wire was cut into 6-in. lengths and bent double to form a U with two 3-in. legs. The wire was twisted with an electric power drill. A 3/8-in.-dia. shaft, 6 in. long, with a head that had two 1/4-in. holes, 3/4 in. apart, was held by the chuck of the drill (see photographs 18-21, Appendix VIII). The U-shaped wire was placed at the junction of the two wires of each of the adjoining widths of mesh, the ends of the wire were inserted into the 1/4-in. holes on the twisting tool and the drill was turned on until the wire was tightly twisted. This operation was performed by one or two men placing the wire ties and a third man operating the drill.

Materials, Equipment and Labour

(1) Construction of the wire panel

|                  |               |
|------------------|---------------|
| Labour           | 194 man hours |
| Front-end loader | 1 hour        |

(2) Move mesh to test site

|                  |             |
|------------------|-------------|
| Labour           | 4 man-hours |
| Front-end loader | 5½ hours    |
| Mobile crane     | 1 hour      |

(3) Position wire mesh on site

|                  |              |
|------------------|--------------|
| Labour           | 39 man-hours |
| Front-end loader | 1 hour       |

(4) Materials

|                         |          |
|-------------------------|----------|
| 66/44 welded wire mesh  |          |
| 140' x 60' = 8400 sq ft |          |
| at \$6.35/100 sq ft =   | \$533.00 |

|                             |         |
|-----------------------------|---------|
| 200 lb. annealed galvanized |         |
| No. 9 wire at 15.32/100 lbs | \$30.64 |

Although the operation had no major snags, it is a time- and labour-consuming job. The wiring of the lengths of mesh could be organized into a more efficient operation on a larger scale, thereby improving labour efficiency. The power drill wire-twisting device described above proved to be considerably more efficient than the patented commercial device for the same purpose.

If it is possible to get widths of mesh greater than 5 feet, the wiring cost can be proportionately decreased.

The wiring together of the ends of two lengths, where the mesh laid over one bench joins that over the next bench, could be done in a similar fashion, without difficulties, after installation on site. An overlap of 1 ft instead of 6 in. might be preferable, to ensure retention of longitudinal strength.

It is doubtful that mesh panels of much greater than 55 ft width could be conveniently handled and placed in position. In consequence, on a major installation, adjacent panels of mesh should be wired together on site after installation if lateral continuity of the mesh is to be retained. An overlap of 3-4 ft might be desirable in this case. The wiring of adjacent panels together after installation would be considerably more difficult than was experienced above; a technique for doing this would have to be developed.

#### Steel Rod Stringer Beam and Abutments

The upper stringer beam used to support the welded wire mesh was composed of five 56-ft-long, No. 11 A432 steel rods. These rods were held in position by the concrete abutments at each of the anchors. The welded wire mesh passes under these rods and was fastened to them with No. 9 galvanized iron wire. The rods were fastened to the reinforcing steel in the abutments

to hold them in position until the concrete had been poured.

Materials, Equipment and Labour

Forming and Steel Work

|                                 |                           |
|---------------------------------|---------------------------|
| Labour                          | 50 man-hours              |
| Reinforcing steel for abutments | \$16.00 total             |
| No. 11 A432 steel bars          | \$142/ton + tax + freight |
| Forming materials               | \$30.00 total             |

Concrete Work

|   |              |
|---|--------------|
| Labour  | 10 man-hours |
| Class 4000 concrete<br>3½ cu yds at \$22.30/cu yd = | \$78.00      |

Positioning of Rods and Fastening Rods  
to Wire Mesh

|        |              |
|--------|--------------|
| Labour | 32 man-hours |
|--------|--------------|

The configuration of the wall in the area of the abutments made installation of forming and steel work rather difficult and inefficient. A project with a greater number of abutments would quite likely result in more efficient usage of labour and materials.

Concrete Stringer Beam and Abutments

The lower stringer beam to support the welded wire mesh is of reinforced concrete integrated with the concrete abutments for the anchors. The main structural steel members are six No. A432 steel rods, 56 feet long. The welded wire mesh was positioned to pass through the concrete which, when poured and set, fastens the mesh to the beam.

Materials, Equipment and LabourForming and Steel Work

|                                 |                           |
|---------------------------------|---------------------------|
| Labour                          | 61 man-hours              |
| Reinforcing steel for abutments | \$20.00 total             |
| No. 10 A432 steel bars          | \$142/ton + tax + freight |
| Forming materials               | \$50.00 total             |

Concrete Work

|                     |                          |
|---------------------|--------------------------|
| Labour              | 15 man-hours             |
| Class 4000 concrete | 12 cu yds at 22.30/cu yd |

The wall configuration in this area was more regular than on the upper bench, resulting in more efficient operation for the forming and the steelwork. Here, again, it is anticipated that a larger project would result in labour and material savings.

Anchors

The main support for the system is created by the installation and tensioning of deep anchors. Four anchors were installed in this project: three were in the Freysinnet principle which uses multiple-strand cable tendons, and one was a high-tensile steel bar, 1 3/8 inches in diameter, called a "Stressteel" bar.

Materials for the 12/0.5 tendons were shipped to the job site in bulk and assembled by a crew of two men and an experienced supervisor from Conenco Canada Ltd.

Assembly and Installation of Anchors

Type 1 12/0.5 Cable Tendons

|              |                  |                      |
|--------------|------------------|----------------------|
| <u>No. 1</u> | Anchor length    | 40 ft                |
|              | Hole depth       | 33 ft                |
|              | Hole size        | 3.89 in. (HX)        |
|              | Hole orientation | 10° below horizontal |

Three men could assemble this anchor from an on-site source of materials in 1½ hours, and install immediately after assembly.

$$\text{Total labour } 3 \times 1\frac{1}{2} = 4\frac{1}{2} \text{ man-hours}$$

No difficulty was experienced with the installation of this anchor into a 3.89-in. hole. A diamond drill hole of 3½-in. diameter would be quite acceptable for this length of anchor.

|              |                  |                      |
|--------------|------------------|----------------------|
| <u>No. 2</u> | Anchor length    | 120 ft               |
|              | Hole depth       | 110 ft               |
|              | Hole size        | 3.5 in. (NX Casing)  |
|              | Hole orientation | 10° below horizontal |

Three men assembled this anchor from the bulk source of material in 3 hours, installing the anchor as it was assembled.

$$\text{Total labour } = 3 \times 3 = 9 \text{ man-hours}$$

No difficulty was experienced with the installation of this anchor into a 3½-in.-dia. hole.

|              |                  |                      |
|--------------|------------------|----------------------|
| <u>No. 3</u> | Anchor length    | 205 ft               |
|              | Hole depth       | 196 ft               |
|              | Hole size        | 3.89 in. (HX)        |
|              | Hole orientation | 10° below horizontal |

A three-man crew was able to assemble this anchor from bulk and install it in approximately 6 hours. Installation to approximately 130 ft created no difficulties. From 130 ft to approximately 170 ft, two more men were required to assist in pushing the anchor down the hole. At 170 ft the hole passed through a fault extending for approximately 4-5 ft; this fault produced caving ground in the hole. It was difficult to push the anchor through this caved ground; nevertheless, by brute force with seven men pushing on the anchor, it was forced to within 2 ft of the bottom of the hole where, presumably, caved material pushed ahead of the anchor prevented further insertion. Due to the weight and length of the anchor it is suggested that the hole diameter not be reduced without further experiment. As a result of these experiences it is also suggested that, during drilling of the anchor holes, the holes should be grouted where caving ground is indicated by the extracted core. This would considerably assist anchor installation through caving ground. From the experiences indicated by these installations it would appear that a 3.5-in.-dia. hole is adequate for installing 12/0.5 cable anchors in holes of up to 100-120 ft, provided the hole condition is good. Above this depth the anchor hole diameter is probably best increased to 3.89 in. These approximate figures apply to these holes dipping at 10° below horizontal. It would be anticipated that these lengths could be increased in more steeply dipping holes. It is questionable whether a deep anchor could be properly installed in holes drilled up dip. Such practice is not recommended without further experiment. If percussion-drilled holes were drilled, it is anticipated that the hole surface would be rougher than these diamond-drilled holes; in consequence, the hole diameter should probably be increased at a smaller depth than the 100-120 ft indicated above, if easy installation is to be maintained.

Total labour =  $3 \times 6 = 18$  man-hours

To assist in estimating installation and assembly costs for 12/0.5 cable tendons, the above labour hours have been plotted against hole depth in Figure 12. This figure indicates that these costs might be estimated on the basis of assuming a value of 0.09 man-hours/ft to cover both assembly and installation.

Type 2 1 3/8 inch Stressteel Bar

|       |                  |                      |
|-------|------------------|----------------------|
| No. 1 | Anchor Length    | 62 ft                |
|       | Hole depth       | 55 ft                |
|       | Hole size        | 3.5 in. (NX casing)  |
|       | Hole orientation | 10° below horizontal |

Three men could assemble and install this anchor with no difficulty in one hour. The unit installed came in a maximum length of 20 ft. Lengths of 40 ft are normally available and would reduce installation time and cost to some degree. Couplings used on the stressteel bar were of the grip type (3-in. O.D.). If a threaded type were used (2 1/4-in. O.D.) it would be possible to remove the grout tube, which was not possible with this installation.

Total labour cost = 3 hours

The labour costs of installation of the bar would appear to be less than those for the cable tendons. Also from this one experience, it appears that the bar is easier to install and that probably a 3.5-in. hole (or perhaps even smaller) could be used to considerably greater depths than with the cable tendons. It should be borne in mind, however, that the stressteel bar has a capacity of only about  $\frac{1}{2}$  the load of the cable tendons used; hence, whilst installation costs are lower with the stressteel bars,

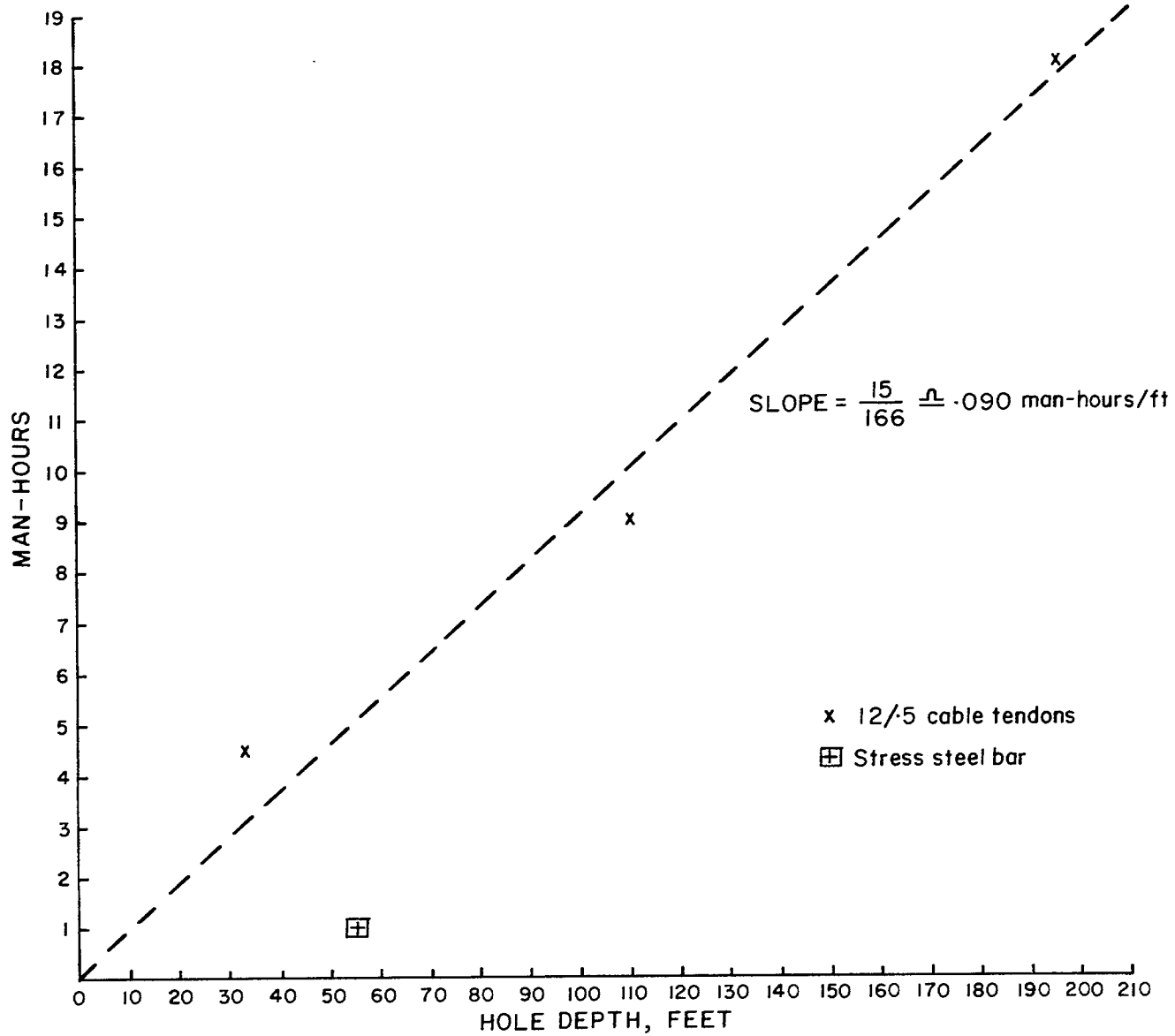

Figure 12. Cable Assembly and Installation Time Versus Depth of Anchor Hole, for 12/.5 Cable Tendons.



almost twice the number would be required to apply the same total support load, thus also involving almost twice the amount of drilling. In consequence, it is unlikely that the overall costs for supporting by means of stressteel bars would be less than those for the cable tendons, unless bars of much higher capacity became available.

#### Materials for the Anchors

##### Type 1 - 12/0.5 tendons

|   |         |
|---|---------|
| Fixed cost per anchor (end fittings,<br>cone-locking device, etc) | \$40.37 |
|---|---------|

|   |         |
|---|---------|
| Additional cost per foot (cable<br>tendon material) | \$ 1.20 |
|---|---------|

##### Type 2 - 1 3/8 stressteel bar

|  |         |
|--|---------|
| Fixed cost per anchor (end fittings, etc.) | \$19.04 |
|--|---------|

|                          |         |
|--------------------------|---------|
| Additional cost per foot | \$ 1.82 |
|--------------------------|---------|

This cost per foot of the bar is up to 40 ft; thereafter, \$7.80 for each additional 40 ft or less should be added for thread and coupler.

The overall assembly and installation of the anchors went quite smoothly, and it is unlikely that much room for improvement is available for a major installation. For a larger project, it is likely that materials could be purchased more economically than was possible for this trial.

#### Grouting of Anchors

Grout was pumped down 1/2-in. or 3/4-in. plastic pipe so that it covered the bottom 20 feet of the anchors. The following grouting equipment was supplied by Conenco Canada Ltd., who supervised the grouting work: electrically powered mixer and tank, and gasoline-powered pump.

The grout was mixed in the following proportions: one-quarter pound of Sika Intraplast expansion grout per sack (87 1/2 lbs) of High-Early-

Strength Cement, with 4 gallons of water.

After the grout was thoroughly mixed, approximately 8 gallons of grout was poured into the tank of the pump; this was the average quantity required to grout one anchor. After the grout had been pumped in, the grouting tube was slowly pulled out before the grout had set. The grout tubes were removed from all holes but the hole with the bar where the size of the couplings had jammed the grout tube between them and the wall.

A three-man crew with the proper equipment on site can grout an individual anchor with no difficulty in 2 hours. This requires that the material and equipment be on site.

Materials and Labour

|  |                      |
|--|----------------------|
| 3 men at 2 hours per hole  | 6 man-hours per hole |
| 8 gallons grouting mixture per hole                                | \$5.00 per hole      |
| Mixer and grout pump rental  | \$50 → \$75/month    |
| (On a continuous project it would pay to purchase this equipment.) |                      |

Grouting of the anchors would be more efficiently carried out on a large scale when more than one anchor could be reached from one set-up. It is the opinion of the Conenco personnel that the leaving of the grout tube in a 12/0.5 tendon during tensioning would only result in damage to the tube and render it useless for additional grouting. They suggest that additional grouting could be achieved by the insertion of a grout tube in the collar of the hole after tensioning.

The grout was allowed to set for 28 days before the cables were tensioned.

### Tensioning of the Anchors

Tensioning of the anchors was supervised by Conenco Canada Ltd., personnel. They used hydraulic jacks and pumps supplied by Conenco which have been specifically designed for this type of work.

Each anchor was tensioned in increments to its approximate design load; it was then unstressed in increments down to almost zero load. This procedure was repeated three times to allow measurements to be made of the displacement of the surface rock as the load was cycled. These measurements during this "plate load test" enabled an estimate of the in-situ modulus of deformation of the surface rock to be made. After readings were completed, the anchor was loaded and locked at its design load. From 4 to 5 hours were required to complete this procedure for each 12/0.5 tendon. About 2 hours was required to complete the same procedure with the rod.

It is estimated that a two-man crew with either a tripod and block and tackle, or some other convenient means of handling the jack for a 12/0.5 tendon, would be able to set up, tension, lock, and dismantle one cable in 1½ hours. Two men could set up, tension, lock, and dismantle for a stressteel bar in 45 minutes under good conditions.

### Equipment and Labour

#### Type 1. 12/0.5 Tendon

|                                 |                   |                          |
|---------------------------------|-------------------|--------------------------|
| Labour                          | 2 men at 1½ hours | 3 man-hours per cable    |
| Jack and electric pump (rental) |                   | \$75/week or \$200/month |

#### Type 2. 1 3/8 stressteel bar

|                                 |                   |                          |
|---------------------------------|-------------------|--------------------------|
| Labour                          | 2 men at 3/4 hour | 1½ man-hours per bar     |
| Jack and electric pump (rental) |                   | \$50/week or \$150/month |

The tensioning of the anchors appears to be a quite straightforward process once the proper techniques have been learned. To achieve the productivities estimated above, it would be necessary to have all materials and equipment on the job site and to be able to move them from one site to the next without significant delay.

#### Final Grouting

After cable tensioning, the whole system was left and its behaviour was monitored over a period of 9 months. The load cells were then retrieved from the cable ends by relaxing and retensioning the cables. The holes were then grouted over their entire length in order to protect the cables and the bar from corrosion. In normal practice this would be done immediately after the initial tensioning of the cables.

The holes were grouted by inserting short plastic pipes into the collars of the holes and sealing these in position with quick-setting mortar. Using the same cement mix as previously and the same pump and mixing equipment, all four holes were grouted in one shift of approximately 6 hours, averaging approximately 58 ft grouting per hour including set-up and dismantling time. A total of 21 bags of grout were used for the 347 ft of grout, averaging  $16\frac{1}{2}$  ft per bag.

|                       |                                  |                     |
|-----------------------|----------------------------------|---------------------|
| Labour                | 2 men for 6 hours                | 12 man-hours        |
| Grouting mix          | $16\frac{1}{2}$ bags at 2.50/bag | \$41.25             |
| Mixer and pump rental |                                  | \$50-\$75 per month |

#### CONCLUSION AND GENERAL COMMENTS

The work done on the trial installation was carried out by men regularly employed by the Company. They were directly supervised by

the regular mine surface foreman. Design and construction control was supplied by the Company's Engineering Department and by personnel of the Mining Research Centre. Services supplied to the workers on the job, such as power, transportation of men and materials, and the use of tools and shops, have not been charged against the project. Neither have the supervision and control mentioned above been charged to the project. In all job breakdowns given in the preceding paragraphs, only hours of labour spent have been indicated.

The distribution of these labour hours would be approximately 50% at a tradesman's rate (carpenter, steel man, etc.) and 50% at a helper's rate. The cost of this labour would vary with individual companies and locations. An approximate cost of any mobile equipment used, such as crane or frontend loader, with operator included, would be in the vicinity of \$10.00 per hour. This would also vary with area, company, and size of equipment.

In order to derive some actual costs, some example labour rates (not necessarily applicable to this or any other mine) have been assumed, together with an allowance of 15% extra to cover the cost of fringe benefits, etc. A total construction cost of this project has then been derived, using these example labour rates, and is given in Appendix IX.

The table below indicates the percentage of the overall costs made by each construction phase.

TABLE 1: PERCENTAGE COST OF EACH PHASE OF CONSTRUCTION

| <u>ITEM</u>                              | <u>% Overall Cost</u> |
|--|-----------------------|
| 1. Site preparation                      | -                     |
| 2. Anchor hole drilling                  | 53.6%                 |
| 3. Wire mesh                             | 17.1%                 |
| 4. Steel rod stringer beam and abutments | 6.3%                  |
| 5. Concrete stringer beam and abutments  | 8.2%                  |
| 6. Anchors and installation              | 10.1%                 |
| 7. Grouting of anchors                   | 1.5%                  |
| 8. Tensioning of anchors                 | 2.0%                  |
| 9. Final grouting of cables              | <u>1.2%</u>           |
|  | 100.0%                |

It is interesting to note from this table that drilling costs account for over 50% of the total. Thus any economies in this work would be best achieved by reducing drilling costs. This makes a very strong case for investigating the possibilities of using percussion drilling rather than diamond drilling, and for conducting some experiments on the ease of installation of anchors in percussion drill holes.

The next most expensive item is the wire mesh installation at 17.1% of the total costs. Of this wire mesh cost, approximately 43% (7.4% of overall costs) is accounted for by the labour involved in wiring the mesh sections together. Significant reduction in overall costs might therefore be obtained by reducing this figure through the use of wider mesh

sections (i.e. if 10-ft-wide mesh is available, these labour costs would be halved, giving an overall saving of 3.7%).

The cost of anchors and their installation (10.1% overall) would not appear to leave much room for potential economies. It is doubtful that the labour costs in this operation could be reduced significantly, since this was one of the most efficient of the operations during this installation. Whilst the fixed cost per anchor of end fittings, etc., might well be reduced by bulk buying, it is doubtful that this would reduce significantly the total costs.

From a cost point of view there would appear to be little difference in using concrete stringer beams or steel rod stringer beams. Whilst the concrete beams do cost a little more, they also give a better support to the mesh. In consequence, it is probably worthwhile to pay the slightly higher costs and install concrete beams.

In this type of trial installation, where the work load was irregular and not excessive, it was found more efficient to perform the work with regular company personnel rather than contract it out. This was shown in this project, where the Company was able to integrate the work on the project with the regular activities of the work force.

In a major installation of a slope support system, the work load would be much more regular and would have to be integrated into production requirements. In view of the importance of integrating this work with production, it would again seem advisable to carry out this work with mine personnel (possibly 3 men full-time) rather than contract it out.

On the basis of this study, a number of guidelines to estimating the costs of such a support system have been derived. These are summarized below:

TABLE 2: COST ESTIMATING DATA FOR EACH CONSTRUCTION PHASE

| Job  | Rate or cost - for<br>Estimating Overall Costs  |
|--|---|
| <p>1. <u>Site Preparation</u></p> <p>Normal clean up and scaling practice is sufficient for most sites. Involving no additional costs.</p>   | -   |
| <p>2. <u>Anchor Hole Drilling</u></p> <p>For holes up to 120 ft deep, 3.5-inch-diameter hole is adequate unless ground is bad. For hole beyond 120 ft, H(3.89")-diameter holes should be used (both these figures apply to 12/0.5 cable tendons).<br/>For estimating purposes assume H size holes, diamond drilled, are used in all holes.<br/>Estimate on basis of \$11.00/ft.</p>  | \$11/ft   |
| <p>3. <u>Wire Mesh</u></p> <p><u>Materials.</u> Calculate square footage of mesh required, allowing for overlap. Mesh costs, depending on mesh size, e.g. 6 x 6 4/4 mesh \$6.35 per sq ft.</p> <p>Annealed galvanized wire. Estimate on basis of 1/2% of total mesh cost.</p> <p><u>Labour.</u> This is dependent on the number of strips to be wired to form each panel of mesh. Allow 0.26 man-hour per foot to wire adjacent strips. This includes time spent installing. Assume total labour hours split 50-50 between tradesman's and helper's rates.</p> <p><u>Equipment.</u> Assume 8 hours required for equipment (front-end loader and/or mobile crane) to move each panel to site and install.</p> | <p>\$6.35 per sq ft</p> <p>1/2% total mesh cost</p> <p>0.26 man-hours/ft</p> <p>8 hours/panel</p> |



4. Stringer Beams and AbutmentsForming and steel work

Reinforcing steel required calculated on basis of \$142.00/ton.

\$142.00/ton

Labour

Allow 1.2 man-hours per foot of beam (include abutment formwork).

1.2 man-hours/foot

Forming materials allow \$1.00 per ft of beam.

\$1.00/ft

Concrete work

Allow \$23.00/cu yd for concrete.

\$23.00/cu yd

Labour allow 1.25 man-hours/cu yd.

1.25 man-hours/cu yd

All labour split 50-50 tradesman and helper.

5. Cable Anchors (12/0.5 tendons)

Materials. Assume \$40.50 per anchor plus \$1.20 per foot of anchor hole.

\$40.50 per anchor  
\$1.20 per foot anchor  
hole

Labour. Allow 0.09 man-hours per foot for assembly and installation (50-50 tradesman and helper).

0.09 man-hours/ft

6. Grouting of Anchors

Labour: Allow 6 man-hours per anchor.

6 man-hours/anchor

Materials: Grouting cement - allow \$5.00/hole.

\$5.00 per anchor

Equipment rental: Allow \$60 per month.

\$60.00 per month

7. Tensioning Anchors

Labour: Allow 3 man-hours per cable anchor.

3 man-hours/anchor

Jack and pump rental: \$75/week.

\$75/week

8. Final Grouting of Cables

Labour: Allow 0.035 man-hour per foot of hole.

0.035 man-hours/ft  
hole

|   |                      |
|---|----------------------|
| Grout materials: Allow 12¢ /ft of hole.     | \$ .12 per foot hole |
| Mixer and pump rental: Allow \$60.00/month. | \$60.00/month        |

The above figures, designed to assist in estimating overall costs, are based on those from the trial installation. For a larger project, these figures will probably give an overestimate and should be modified as experience dictates.

#### RESULTS OF INSTRUMENTATION STUDIES

##### Instrument Layout

Figure 13 shows a sketch of the instrument layout on the site. The four load cells were installed under the cable-anchor heads of each of the anchors. The load-cell numbers and the anchor depths are indicated in this figure. Likewise, the positions and numbers of the extensometers are given in this figure. Figure 14 shows a section through the extensometer holes, showing the location of the anchors within these holes and the orientation of these holes. The strain gauges installed within the concrete stringer beam were numbered and installed in the pattern and positions indicated in Figure 15.

##### Cable Anchor Tensions

Cable No. 1 (33 ft) was tensioned to 302,850 lbs and the Freysinnet cone was locked, causing the load to drop to 209,930 lbs. Shims were then introduced between the cone and the load cell, and the cable tension was then increased to the "initial load" of 267,600 lbs. This cable was then left in position and the cable tension variations during the ensuing 9 months were

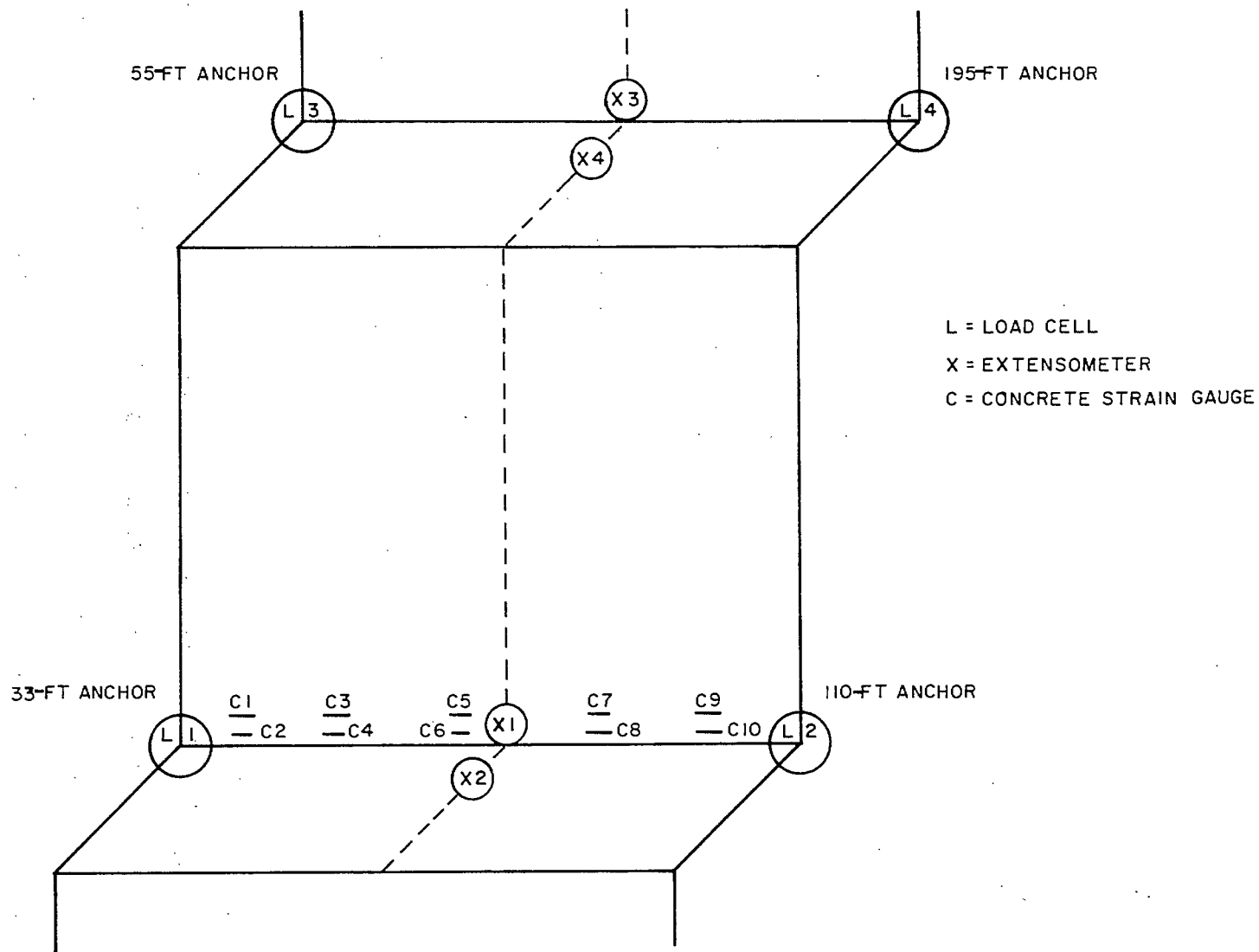

Figure 13. Instrument numbering and layout.

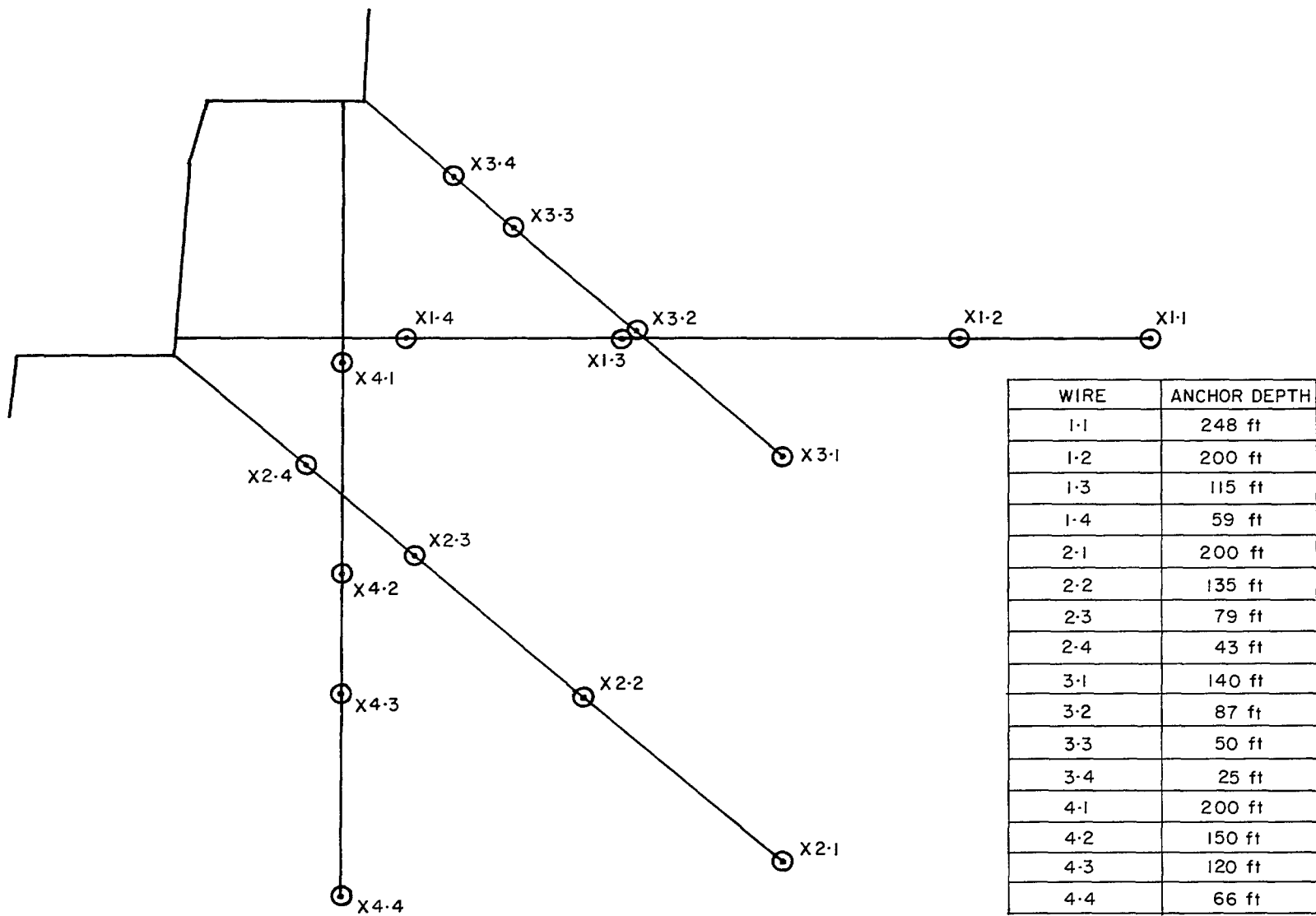
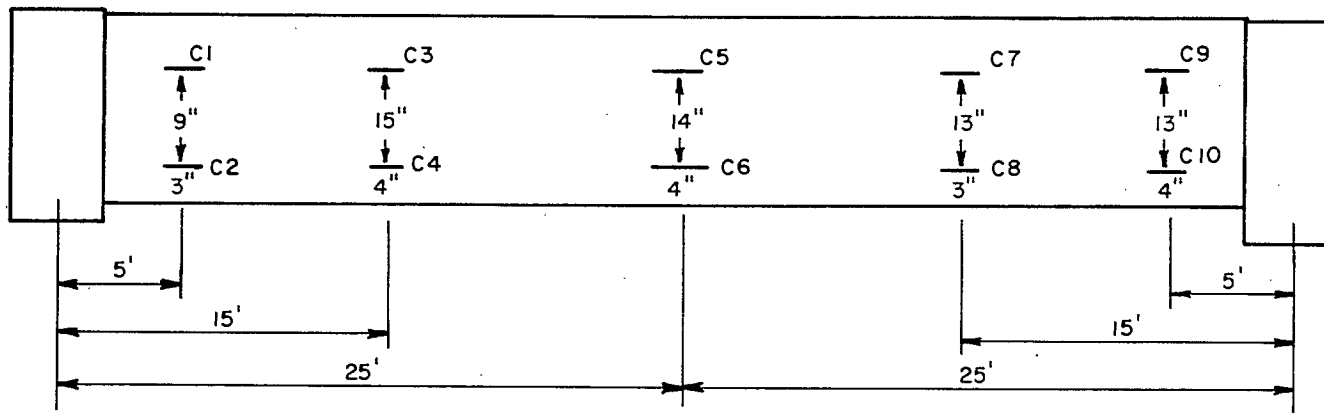
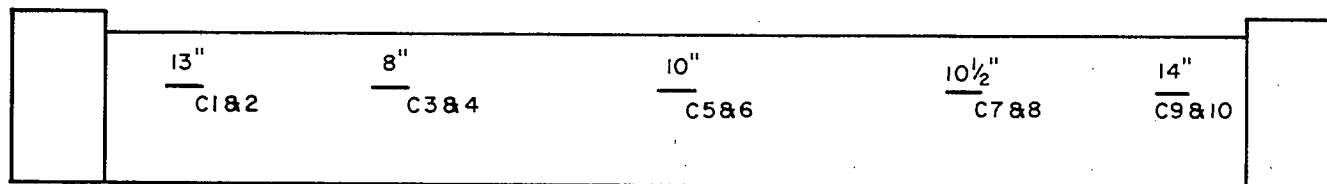

Figure 14. Extensometer anchor positions.



(a) PLAN



(b) SECTION - FACING PIT WALL

Figure 15. Strain gauge positions in concrete stringer beam.

observed, and are plotted on Figure 16. This cable tension remained stable throughout the whole period.

Cable No. 2 (110 ft) was tensioned to a load of 319,700 lbs and the Freysinnet cone was locked, causing the load to drop to 281,380 lbs. Shims were then introduced to increase the cable tension to the "initial load" of 309,250 lbs. This cable lost load rapidly and continuously over the 9-month observation period, and at the end of the time had lost over 30% of the initial load. Figure 17 shows the record.

Cable No. 3 (55-ft steel rod) was tensioned to a load of 113,500 lbs and the bolt was locked. No loss of load was experienced due to locking of the bolt. A slight loss of load was experienced over the 9-month period, but at the end of this time the load was still approximately 103,000 lbs. This record is shown in Figure 18.

Cable No. 4 (195-ft cable) was tensioned to a load of 291,700 lbs, which dropped to 261,900 lbs when the Freysinnet cone was locked. Shims were introduced between the cone and the load cell, raising the load to the "initial value" of 299,660 lbs. During the first month of observation this load dropped to approximately 280,000 lbs, where it remained stable for the rest of the observation period. Figure 19 shows the load-time record.

The following tentative conclusions can be drawn from these observations:

(a) Whilst it is possible to tension the cable anchors accurately to a given load, the act of locking the cone and wedge relaxes some of this tension. This relaxation can be a significant portion of the design load and is probably greater for the shorter cables. After locking the cable, shims can be

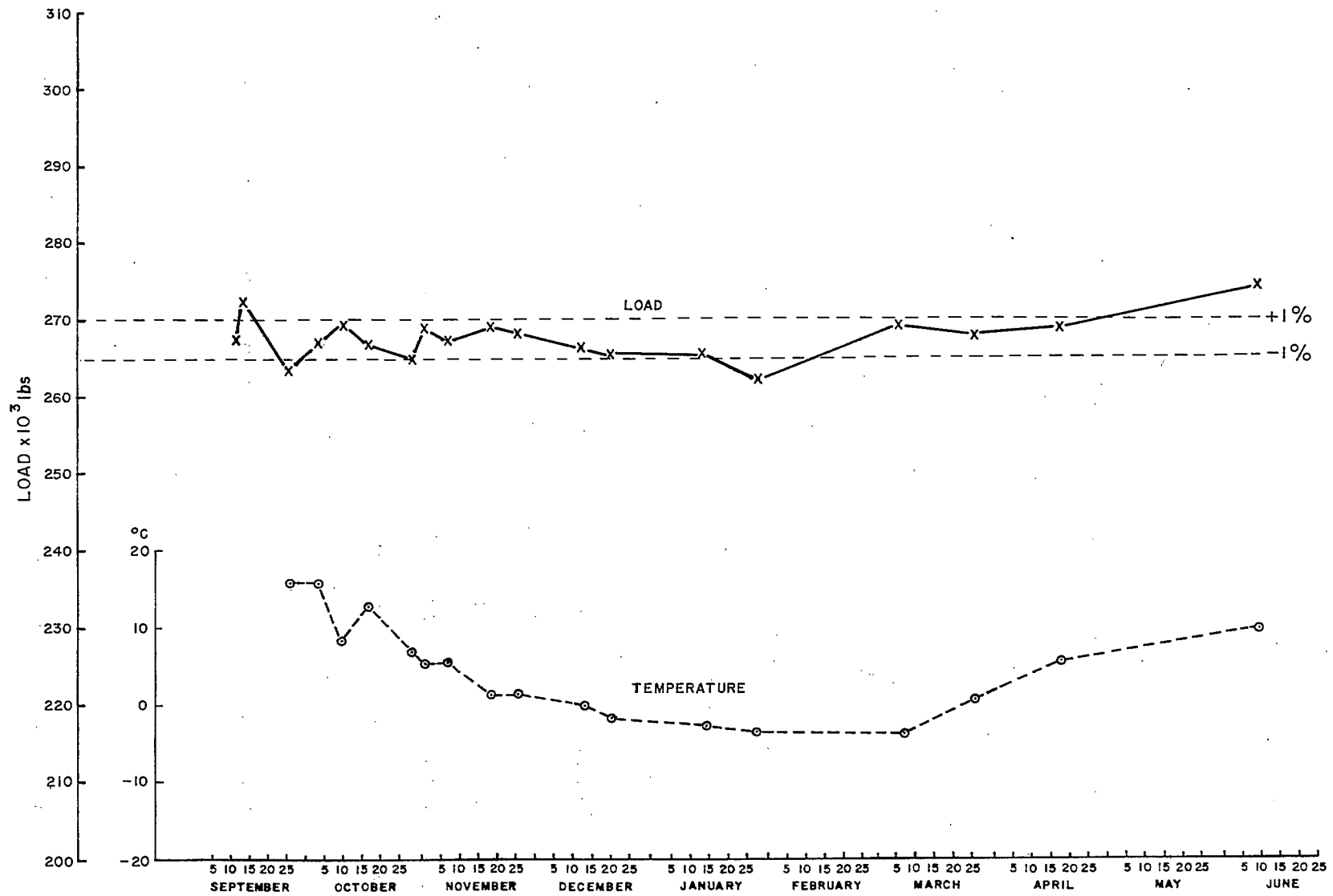

Figure 16. Load cell No. 1 - 33-ft cable - initial load 267,600 lbs.

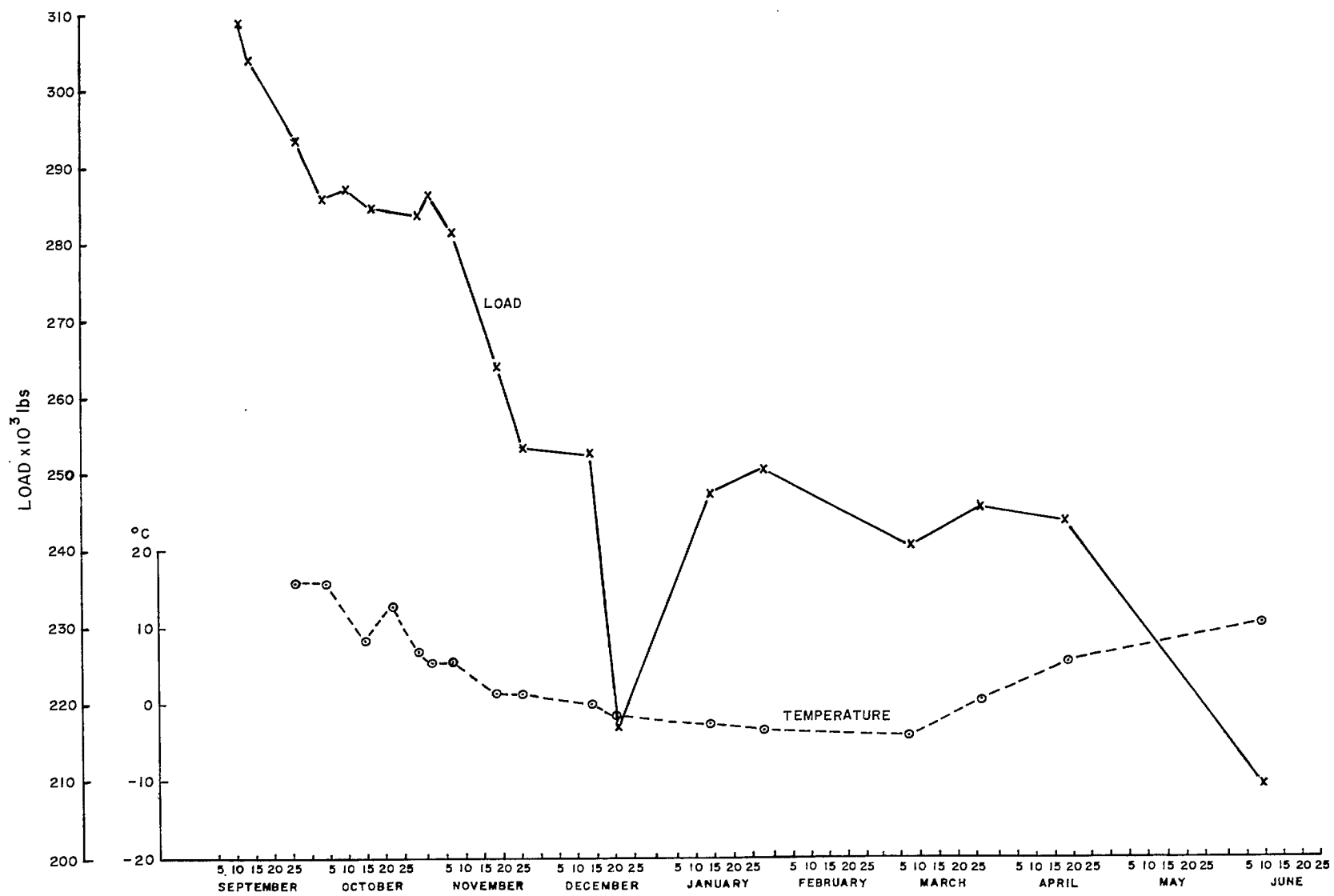

Figure 17. Load cell No. 2 - 110-ft cable - initial load 309,250 lbs.



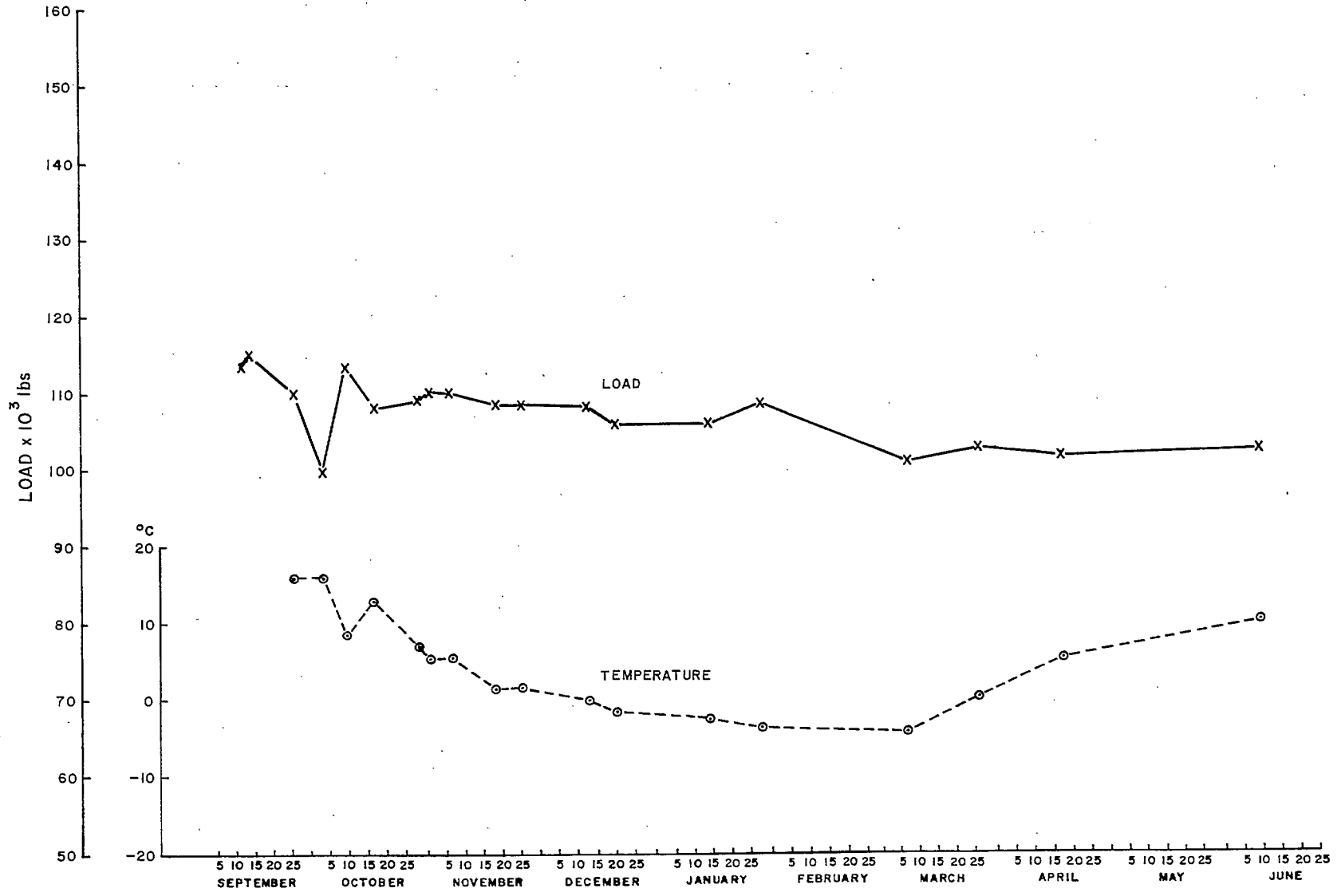

Figure 18. Load cell No. 3 - 55-ft rod - initial load 113,500 lbs.

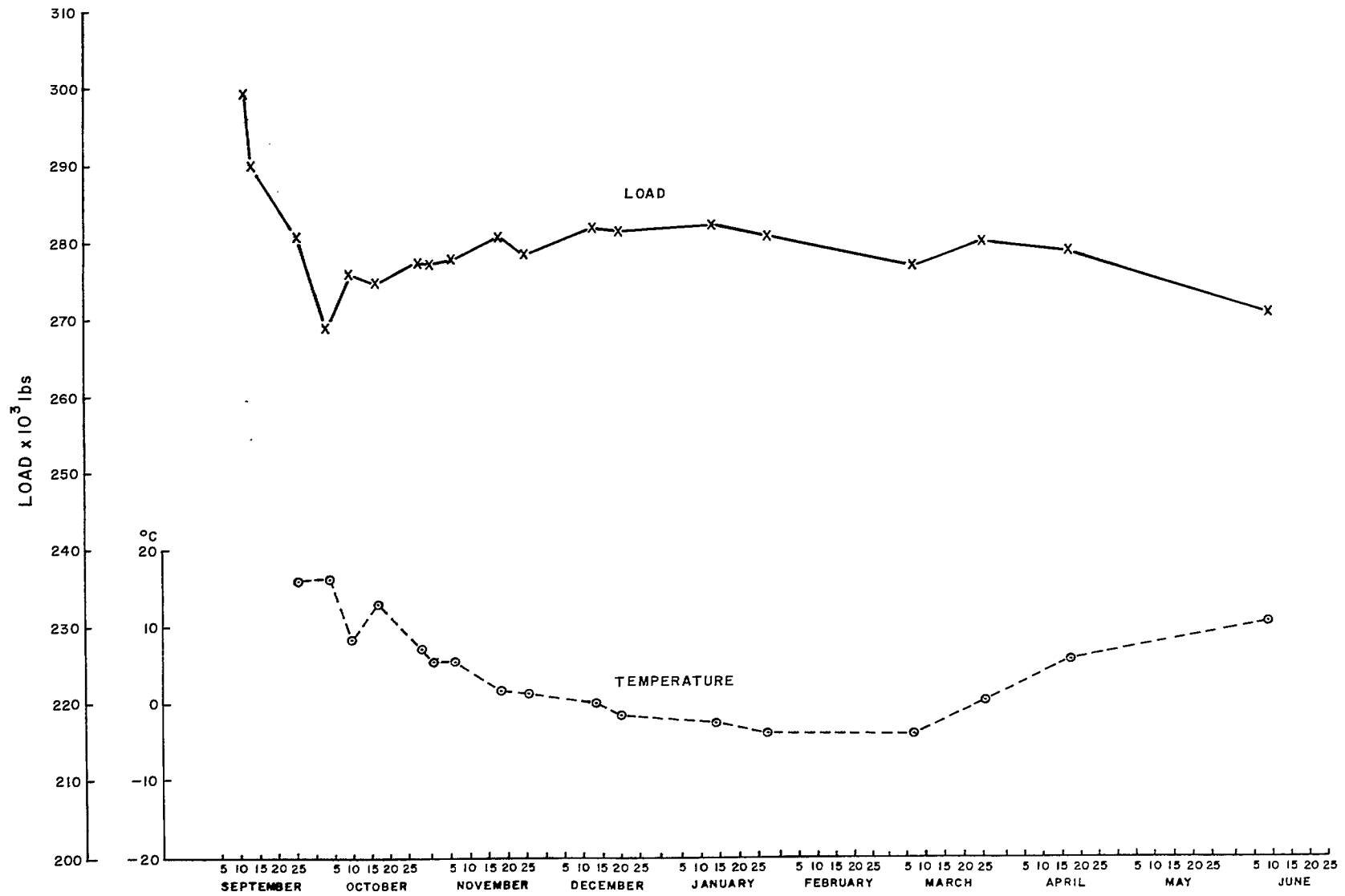

Figure 19. Load cell No. 4 - 195-ft cable - initial load 299,660 lbs.

inserted between the wedge and the bearing plate (or load cell), which will increase the load towards the design load. However, this load will only be accurately known if there is a load cell incorporated in the system. It is not normal practice to use such a load cell on every anchor, as the costs then increase considerably. In consequence it is probable that the tension on the cable when finally installed will not be accurately known and it could deviate by a significant amount from the design load. Experience may enable some allowance to be made for the relaxation during locking.

(b) The above problem was not experienced with the stressteel bar; no relaxation during locking procedures occurred in this one case.

(c) After shimming, load cell No. 1 on the 33-ft cable remained stable throughout the observation period. However, load cell No. 2 on the 110-ft cable showed a continuing load loss. This was believed to be due to slip in the anchorage, either at the bottom in the grout anchor or at the top between the cone and wedge. In normal practice, however, the entire cable would be grouted over its whole length immediately after final tensioning. In consequence, this type of load loss would not normally be experienced.

The rod and the 195-ft cable both showed some loss of load during the first few weeks; thereafter the load remained stable. This load loss is probably due to time-dependent compaction of the rock under load, closing of fissures, etc. It is significant that the 33-ft cable, which received 3 load cycles during the plate-load tests, did not exhibit this effect since most of the compaction would have occurred during these presetting load cycles. It would therefore seem advisable to precycle the load up to its highest level for several cycles, in order to reduce the load loss after setting.

### Extensometer Measurements

Figures 20, 21, 22 and 23 show the displacements recorded by the extensometers during the 9-month observation period. The behaviour of these extensometers was most unsatisfactory. Extensometers No. 1, 2 and 3 recorded displacements, or rather lack of displacement, reasonably well until mid-January 1969. At this time a cycle of freezing and thawing weather caused much condensation of water and subsequent freezing within the units, in many cases preventing the vibrating wires from moving, and stiffening the springs with ice. In consequence, at this time the readings became erratic and in many instances the wires could not be read. Extensometer No. 4 showed erratic readings from a much earlier date. It is obvious that this behaviour was not a reflection of movement within the slope, since the recorded movements are not reflected in the different wires in the same hole. As a result of these experiences, it is obvious that a number of design changes are required in the extensometer in order to improve its performance, particularly when subject to weather of this nature. The only conclusion that can be drawn from these measurements is that it is probable that little or no movement occurred in the slope up to January 1969. There is no secondary evidence to indicate that movement occurred after this time.

### Concrete Strain Gauges

Figures 24, 25, 26, 27 and 28 show the strains recorded by the pairs of concrete strain gauges embedded in the concrete stringer. With the exception of gauge No. 9, no significant strains were recorded during the 9 month observation period. For some unknown reason, gauge No. 9 showed high strains during the December-to-February period before reverting to the original strain level. This is not believed to be a true strain recording since it is not reflected in any of the other gauges, in particular it is

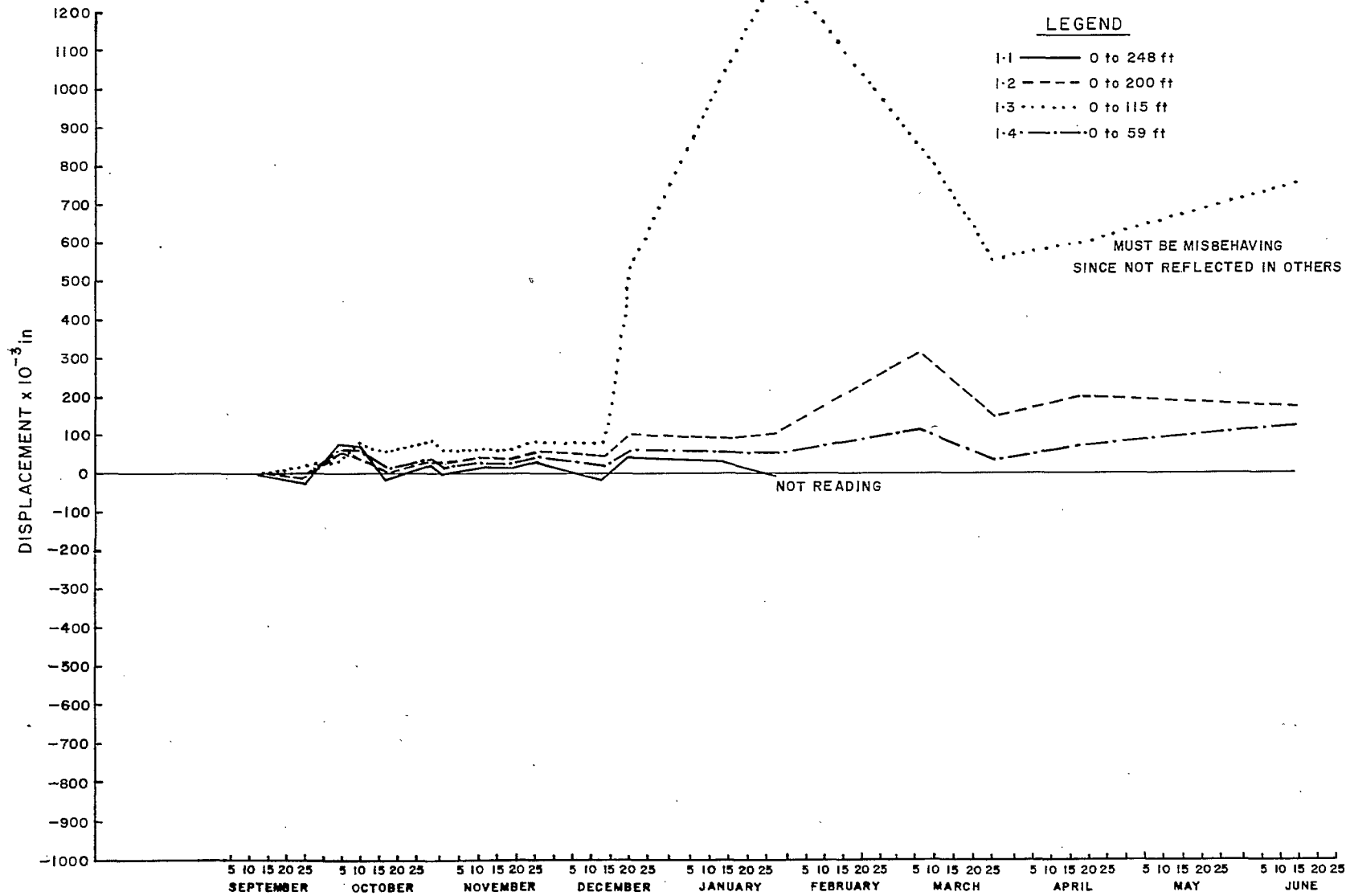

Figure 20. Extensometer No. 1.

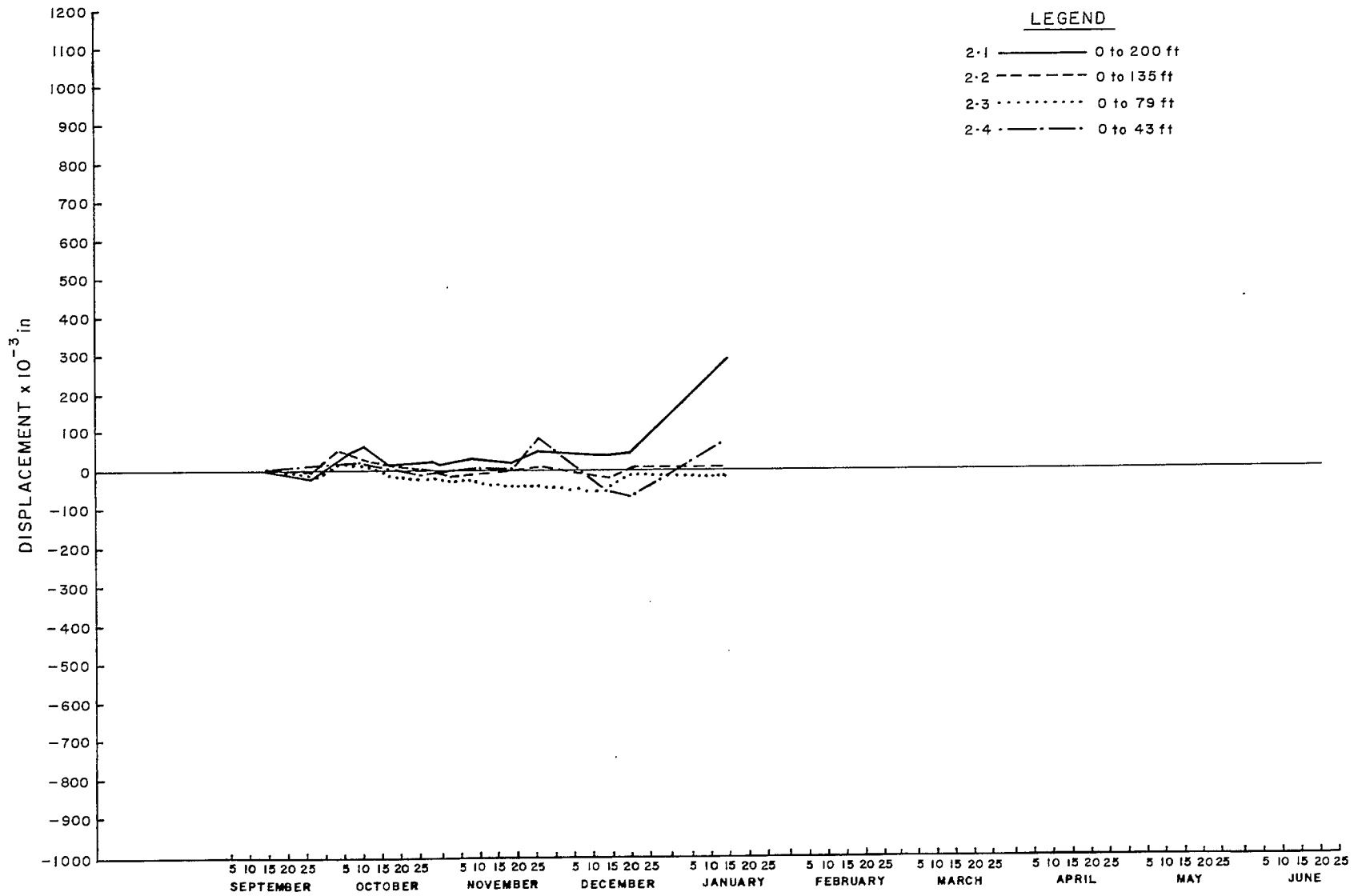

Figure 21. Extensometer No. 2.

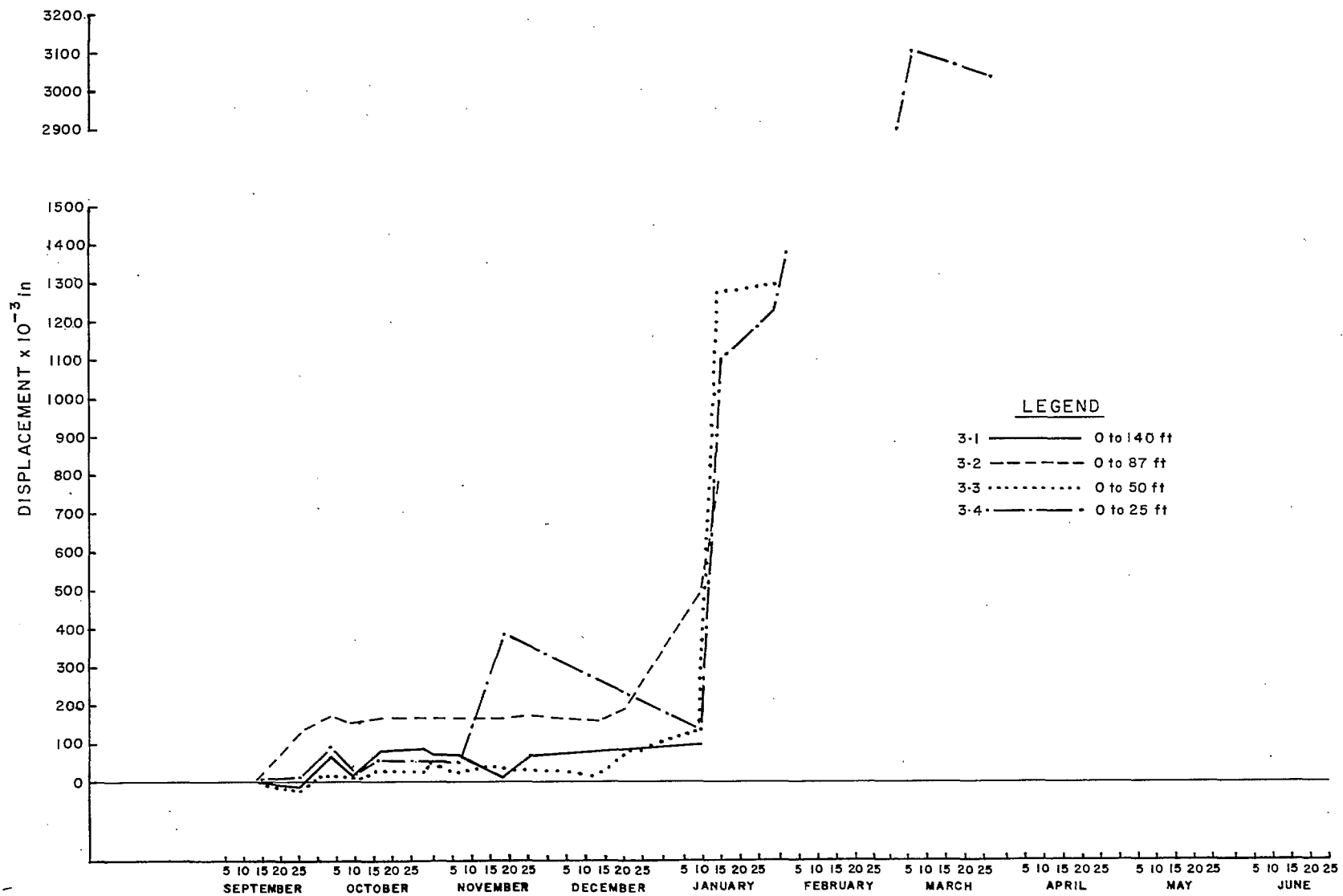

Figure 22. Extensometer No. 3.

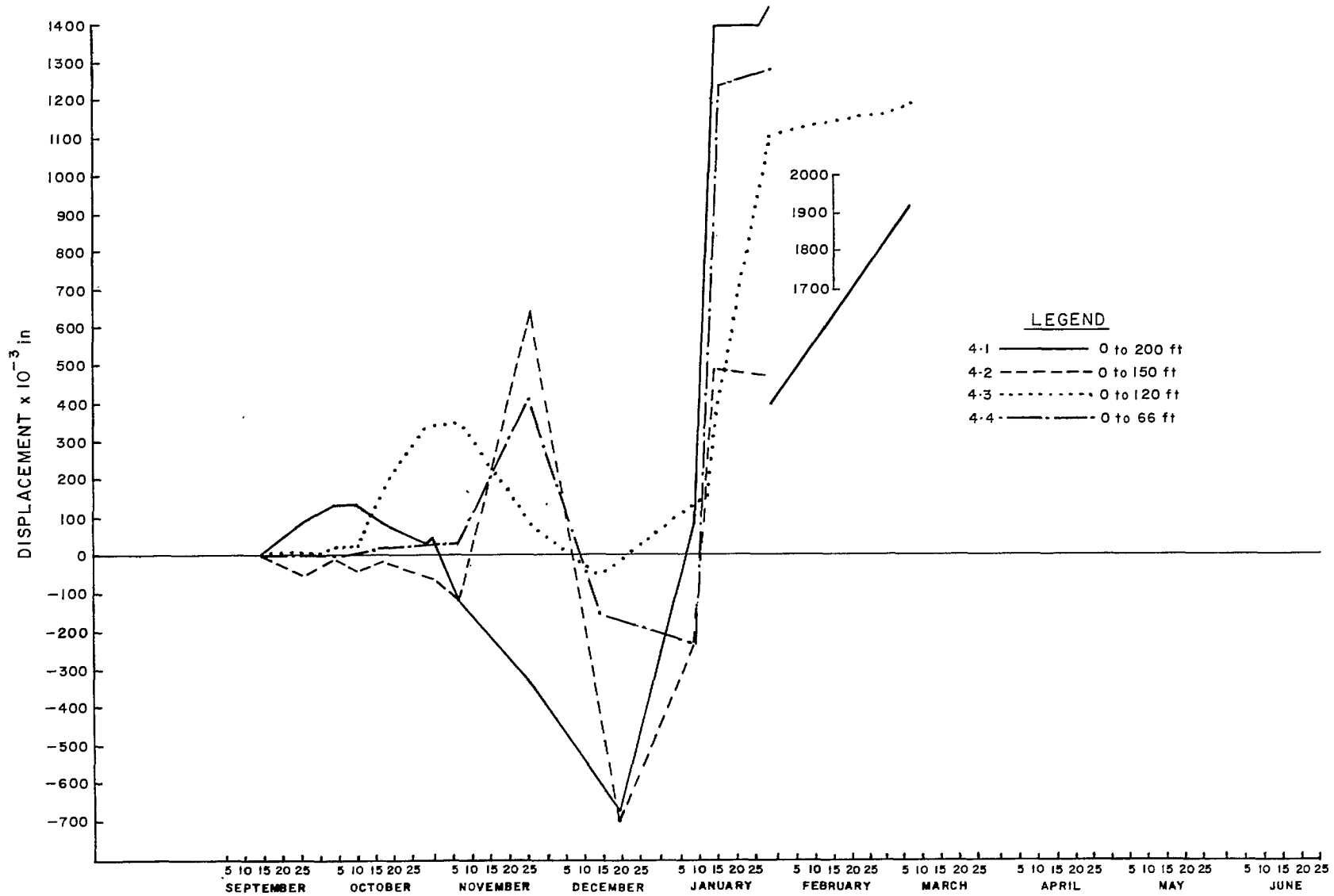

Figure 23. Extensometer No. 4.



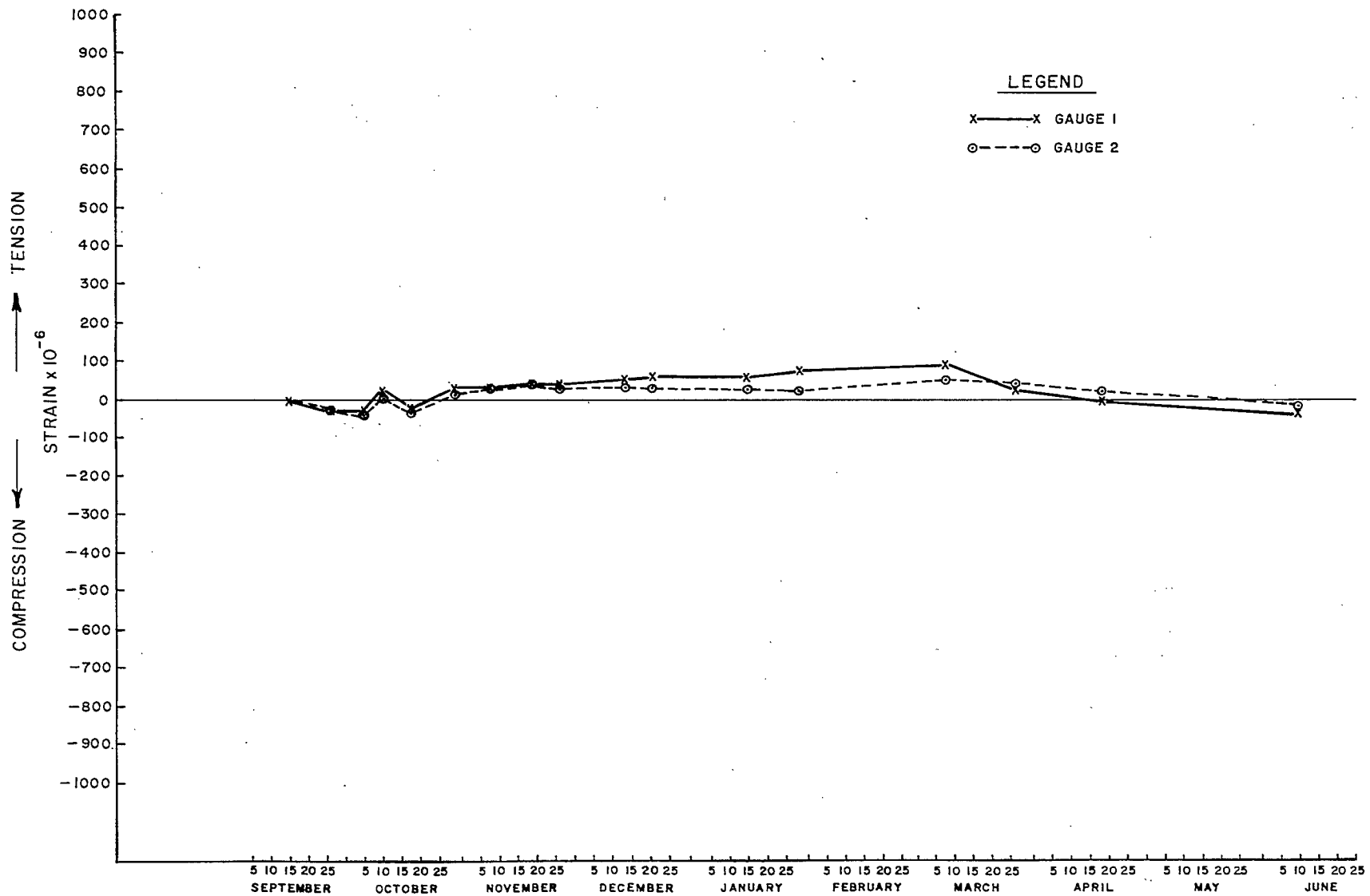

Figure 24. Concrete gauges Nos. 1 and 2.

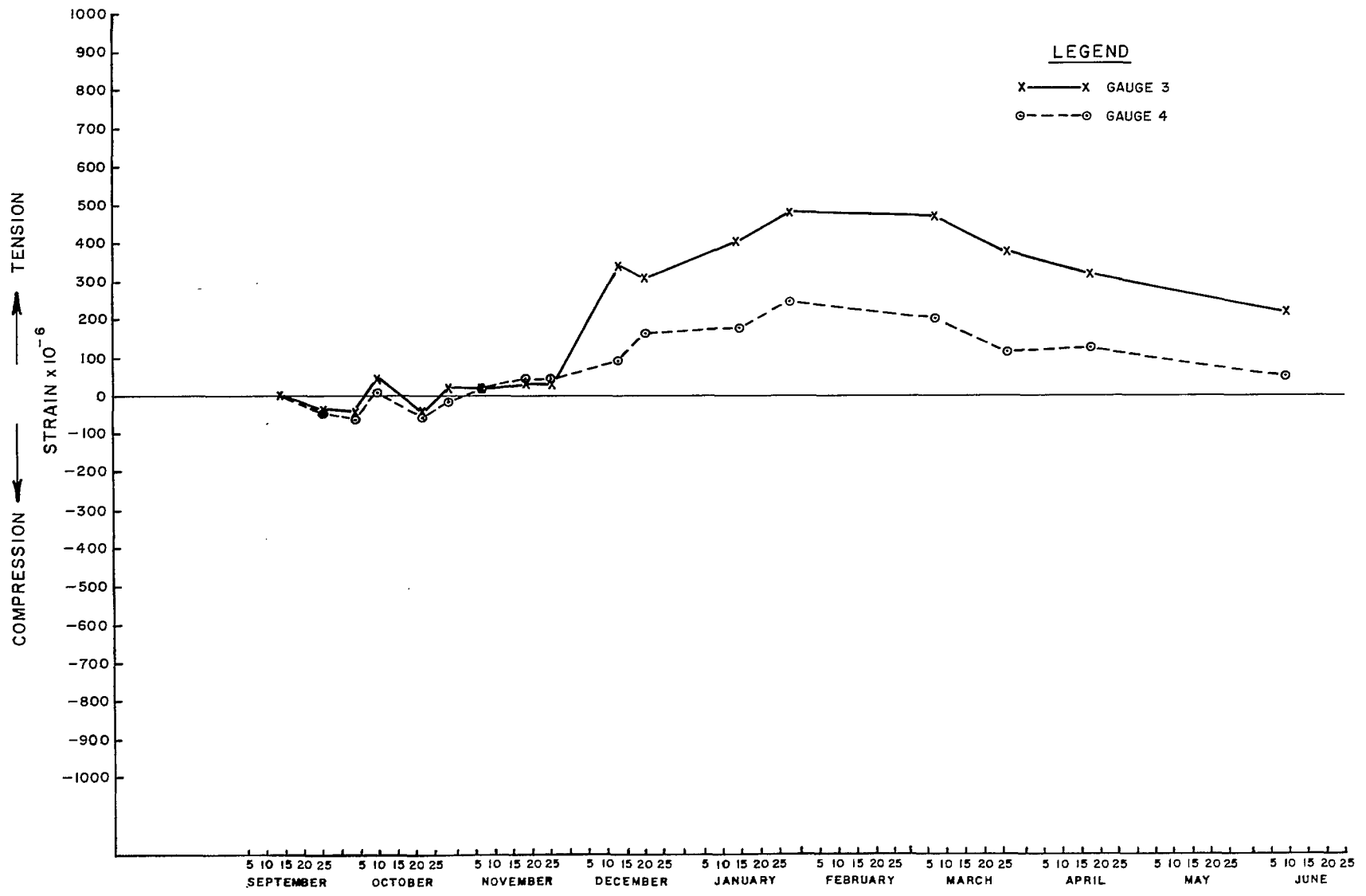

Figure 25. Concrete gauges Nos. 3 and 4.

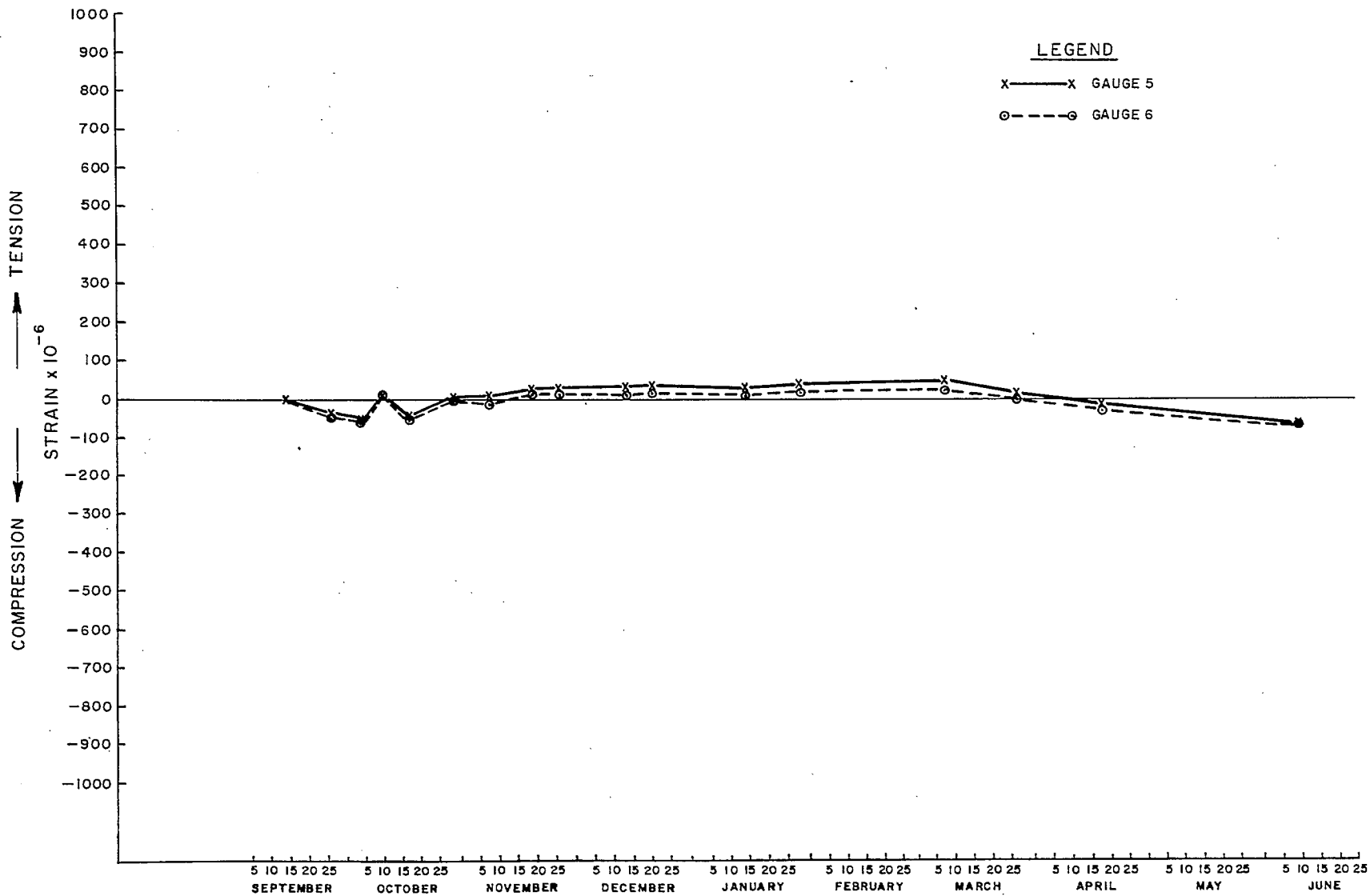

Figure 26. Concrete gauges Nos. 5 and 6.

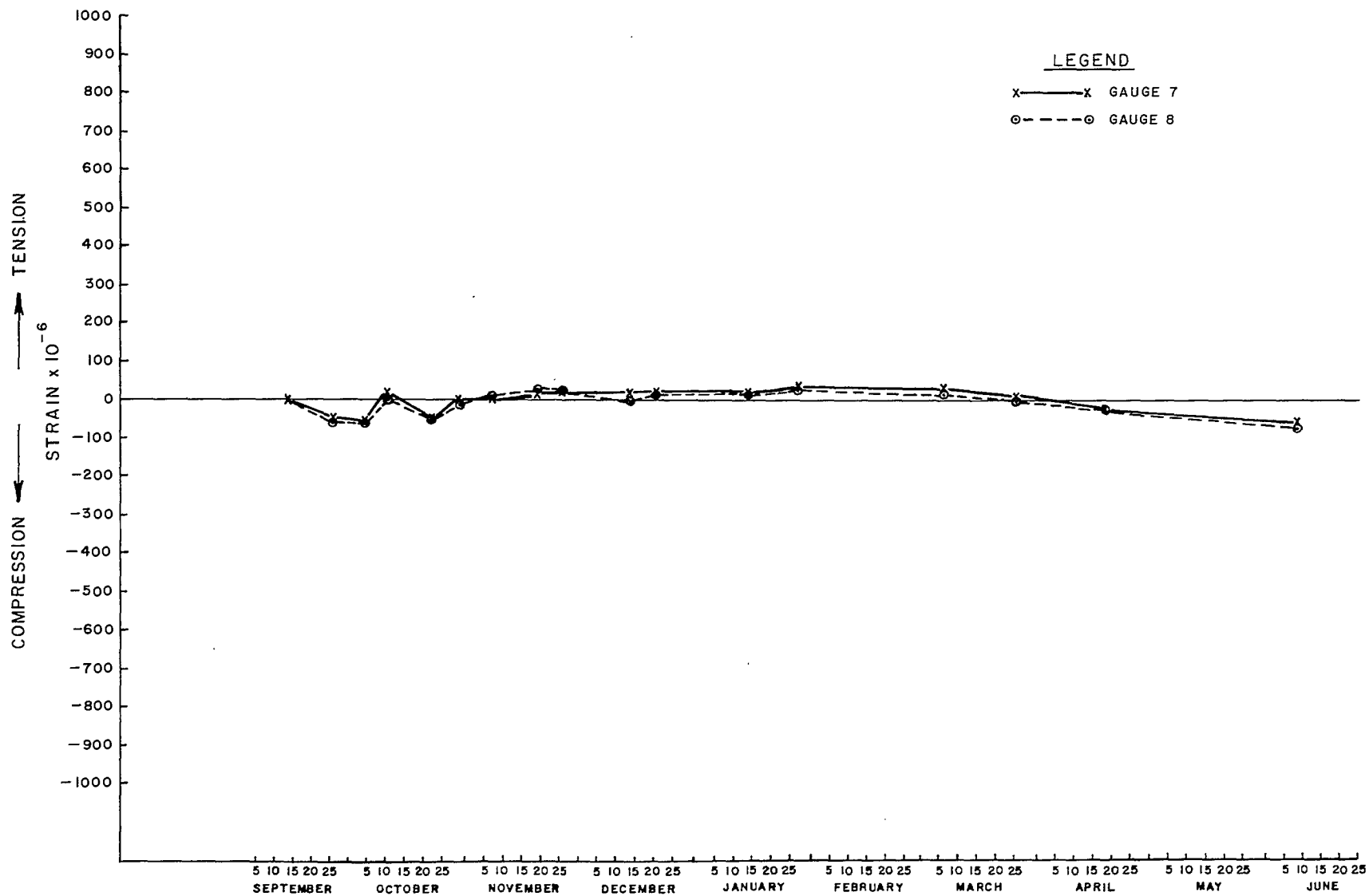

Figure 27. Concrete gauges Nos. 7 and 8.

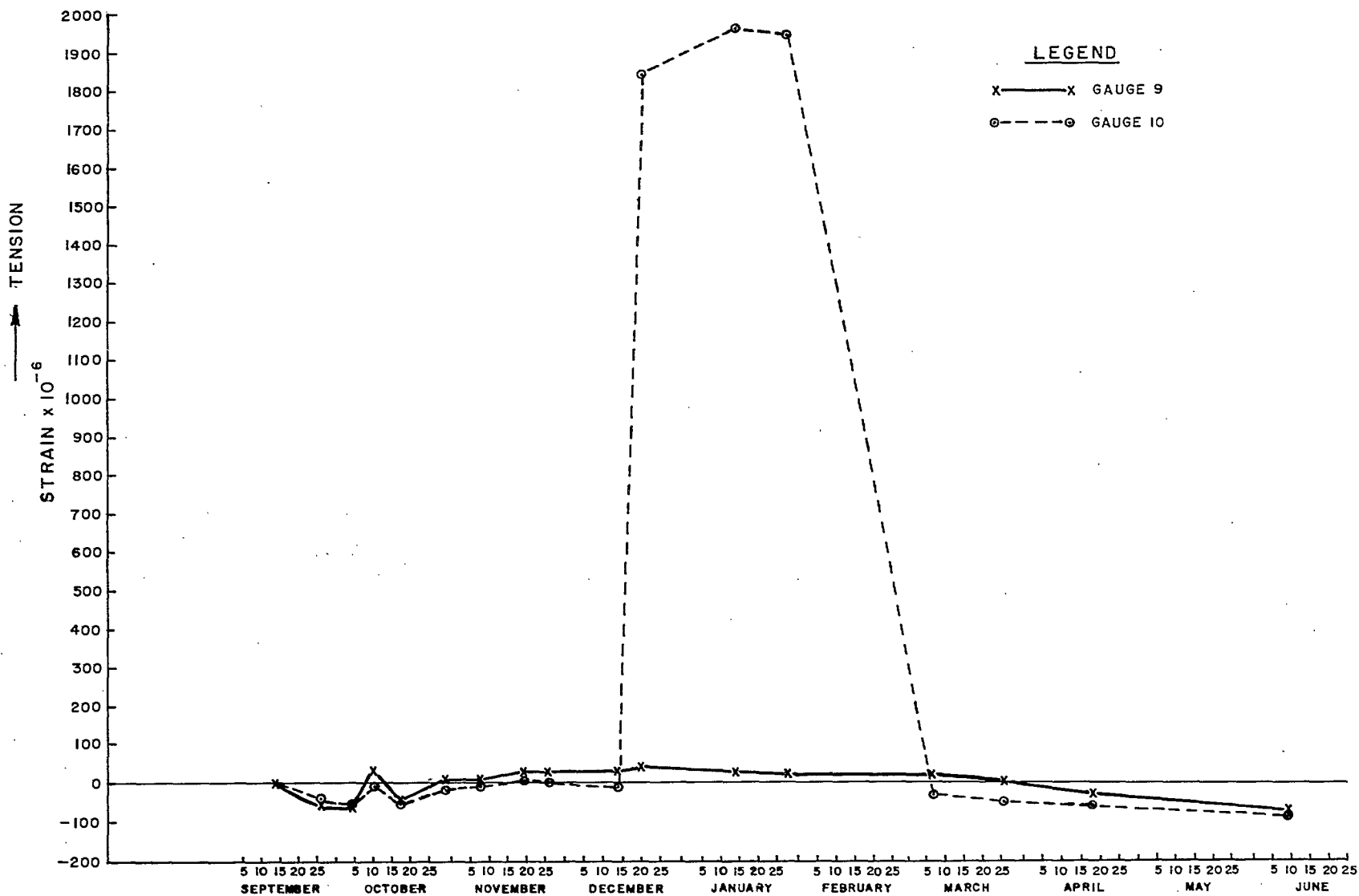

Figure 28. Concrete gauges Nos. 9 and 10.

not reflected in the behaviour of gauge No. 10 adjacent to it. These erratic readings from this gauge must be attributed to some malfunction of the gauge.

It may be concluded that no significant loading was experienced by this horizontal stringer during the period of observation.

#### Plate Load Tests

The plate load tests carried out during the cable tensioning are described in Appendix X. These experiments yielded an in-situ elastic modulus of the surface rock of:  $E = (2.12 \pm 0.51) \times 10^5$  psi with a coefficient of variation of  $\pm 24\%$ . This value is 40 to 50 times less than was measured in laboratory samples, indicating the very large effect of fracturing and fissuring on the in-situ rock mass.

#### Television Viewing of the Boreholes

Appendix XI gives an assessment of the value of viewing the inside of boreholes with a television camera.

#### Instrumentation Costs

Appendix XII gives a breakdown of the instrumentation costs for this project.

PART III: EXAMPLES OF THE PRELIMINARY DESIGN AND COST ESTIMATES  
FOR A MAJOR SUPPORT PROJECT

INTRODUCTION

In order to illustrate the potential application of supports as an economic means of increasing slope angles, it is our intention in this part of the report to use the analyses presented in Part I to establish a preliminary design of supports for a number of hypothetical slope configurations. The cost estimate data derived in Part II will then be used to estimate the costs of these various support systems and their relative economic merits.

THE HYPOTHETICAL PROBLEM

Assume that it is desired to mine an open pit to a depth of 500 ft and that the benches will be 50 ft high and 30 ft wide. Assume that the slope contains bedding or joint planes dipping at an angle of  $40^\circ$  to the horizontal. Consider the preliminary design of a support system to stabilize this pit slope at angles of  $\alpha = 35^\circ, 40^\circ, 45^\circ, 50^\circ, 55^\circ,$  and  $60^\circ$  with a required safety factor of 1.5. Assume that the coefficient of friction has been estimated by experiment to be  $\mu = 0.75$ . Let  $\gamma$  the density of the rock be 165 lbs/cu ft.

SLOPE STABILITY ANALYSIS

1. Determine the angle  $i^\circ$  of the plane of maximum excess shear stress

$$\text{From equation (5), } \cot \alpha = \cot i + \left\{ \frac{\mu \cot i - 1}{\sin 2i + \mu \cos 2i} \right\}$$

which has been plotted in Figure 5 for all values of  $\mu$  and  $\alpha$ . Hence the values of  $i^\circ$  for each of the values of  $\alpha$  required are given by:

|          |                       |                       |            |            |            |            |
|----------|-----------------------|-----------------------|------------|------------|------------|------------|
| $\alpha$ | $35^\circ$            | $40^\circ$            | $45^\circ$ | $50^\circ$ | $55^\circ$ | $60^\circ$ |
| $i$      | $34\frac{1}{2}^\circ$ | $37\frac{1}{2}^\circ$ | $40^\circ$ | $42^\circ$ | $44^\circ$ | $46^\circ$ |

2. Determine the optimum angle  $\Delta$  of the cables

From equation (7), the optimum angle  $\Delta$  of the cables is given by:

$$\mu = \tan (i + \Delta)$$

However, assume that we have difficulty in installing cables in holes up dip above  $10^\circ$  from the horizontal. Thus, if the optimum  $\Delta$  is more than  $10^\circ$  up dip ( $-10^\circ$ ), choose  $\Delta = -10^\circ$ .

Hence, for all values of  $\alpha$  and  $i$ ,  $\mu = 0.75$ , i.e.  $\tan^{-1}0.75 = 37^\circ$ . See below:

|                  |                       |                       |            |             |             |             |
|------------------|-----------------------|-----------------------|------------|-------------|-------------|-------------|
| $\alpha^\circ$   | $35^\circ$            | $40^\circ$            | $45^\circ$ | $50^\circ$  | $55^\circ$  | $60^\circ$  |
| $i^\circ$        | $34\frac{1}{2}^\circ$ | $37\frac{1}{2}^\circ$ | $40^\circ$ | $42^\circ$  | $44^\circ$  | $46^\circ$  |
| $\Delta$ optimum | $2^\circ$             | $-3^\circ$            | $-8^\circ$ | $-13^\circ$ | $-18^\circ$ | $-23^\circ$ |
| $\Delta$ chosen  | $+2^\circ$            | $-3^\circ$            | $-8^\circ$ | $-10^\circ$ | $-10^\circ$ | $-10^\circ$ |

3. Calculate the average excess shear stress, per unit thickness, in the plane at  $i^\circ$

From equation (4),  $\tau_e = \frac{Z\gamma}{2} \{ \cot i - \cot \alpha \} \{ \sin^2 i - \mu \sin i \cos i \}$ ;

where  $Z$  = depth of 500 ft,  $\gamma$  = 165 lbs/cu ft, substituting these values into this equation gives:

|                    |            |            |            |            |            |            |
|--------------------|------------|------------|------------|------------|------------|------------|
| $\alpha^\circ$     | $35^\circ$ | $40^\circ$ | $45^\circ$ | $50^\circ$ | $55^\circ$ | $60^\circ$ |
| $\tau_e$ lbs/sq ft | -31        | 41         | 348        | 840        | 1490       | 2280       |



Note that the excess shear stress when  $\alpha$  is  $35^\circ$  is negative, i.e., the natural shear resistance of the slope has not been overcome, and thus the slope would be safe without support at this angle. The shear stress will become positive (i.e. excess about the natural resistance) when  $\mu = \tan i$ , i.e., when  $i = \tan^{-1} 0.75 = 37^\circ$ . We need not, therefore, consider the case of  $\alpha = 35^\circ$  any more.

4. Calculate the required shear resistance which must be mobilized by the cables for a safety factor of 1.5

The shear stress which must be mobilized by the cables must be 1.5 times the excess shear stress  $\tau_e$  in order to obtain a safety factor of 1.5. Hence the required shear resistance,  $\tau_p$ , is given by:

|                    |            |            |            |            |            |
|--------------------|------------|------------|------------|------------|------------|
| $\alpha^\circ$     | $40^\circ$ | $45^\circ$ | $50^\circ$ | $55^\circ$ | $60^\circ$ |
| $\tau_p$ lbs/sq ft | 61.5       | 522        | 1260       | 2235       | 3420       |

5. Calculate the required lateral spacing of the cable anchors

Assume that there are ten 50-ft benches in the 500-ft depth, i.e., that there are 11 cables required in each vertical section for full bench spacing ( $n = 11$ ,  $a = 50$  ft). Choose the maximum capacity cables to give maximum load with minimum drilling costs, i.e. 270K 12/0.5 strand cable, with design load of 340,000 lbs per cable.

Then, from equation (6), the lateral spacing required is:

$$l = \frac{n P \sin i}{a \tau_p} \{ \cos (i+\Delta) + \mu \sin (i+\Delta) \}$$

Hence the required lateral spacings are:

|                |                       |            |             |             |             |
|----------------|-----------------------|------------|-------------|-------------|-------------|
| $\alpha^\circ$ | $40^\circ$            | $45^\circ$ | $50^\circ$  | $55^\circ$  | $60^\circ$  |
| $i^\circ$      | $37\frac{1}{2}^\circ$ | $40^\circ$ | $42^\circ$  | $44^\circ$  | $46^\circ$  |
| $\Delta^\circ$ | $-3^\circ$            | $-8^\circ$ | $-10^\circ$ | $-10^\circ$ | $-10^\circ$ |
| $\tau p$       | 615                   | 532        | 1260        | 2235        | 3420        |
| 1 ft           | 920 ft                | 114 ft     | 50 ft       | 29 ft       | 22 ft       |

Obviously the spacing of 920 ft required for the  $40^\circ$  slope angle is out of realm of practicability, since the assumption that the cable load is uniformly distributed over the plane at  $i^\circ$  could not possible apply in this case. In practice it would be better to have lower-capacity cables more closely spaced (say 50-100 ft), but this would increase drilling costs considerably and might well adversely effect the economics of the operation. Nevertheless, purely as an academic exercise, the remaining design calculations will still be carried out, using the excessive spacing since it may well illustrate other important points later on.

#### 6. Calculate the length of the cables

From equation 12, the length of the rth cable is given by:

$$L_r = \left\{ \frac{\{Z - (r-1) a\} \sin (\alpha - i)}{\sin \alpha \sin (i + \Delta)} \right\} + x$$

when r is the cable number, counted from the crest, and x is the recommended length of grouting for the cable anchorage, say 20 ft. Now the beds dip into the pit at  $40^\circ$  from the horizontal, so that in some cases considered  $\beta$  is  $\leq i$  the slope angle. Hence, i should be replaced by  $\beta = 40^\circ$  in this equation, to ensure that the cables are anchored beyond the bedding planes which pass through the toe. If this equation yields a length of  $< (15 + x) = 35$  ft, then a minimum cable length of 35 ft should be used. Hence the cable lengths for each hole are:

| Cable No.     | $\alpha = 40^\circ$ | $\alpha = 45^\circ$ | $\alpha = 50^\circ$ | $\alpha = 55^\circ$ | $\alpha = 60^\circ$ |
|---------------|---------------------|---------------------|---------------------|---------------------|---------------------|
| 1             | 80.5 ft             | 137.5               | 240                 | 337                 | 415                 |
| 2             | 74.5                | 126                 | 218                 | 306                 | 371                 |
| 3             | 68.5                | 114                 | 196                 | 274                 | 336                 |
| 4             | 62.5                | 102                 | 174                 | 242                 | 297                 |
| 5             | 56.5                | 90.5                | 152                 | 210                 | 257                 |
| 6             | 50.5                | 79                  | 130                 | 179                 | 218                 |
| 7             | 44.5                | 67                  | 108                 | 147                 | 178                 |
| 8             | 38.5                | 55                  | 86                  | 114                 | 138.5               |
| 9             | 35 *                | 43.5                | 64                  | 83.5                | 99                  |
| 10            | 35 *                | 35*                 | 42                  | 52                  | 59.5                |
| 11            | 35 *                | 35*                 | 35*                 | 35*                 | 35*                 |
| Total footage | 581                 | 884.5               | 144.5               | 1980.5              | 2409                |

\*MINIMUM length =  $x + 15' = 35$  ft chosen.

The following Table 3 therefore summarises the cable support guidelines derived from this analysis.

TABLE 3: SUMMARY OF CABLE SUPPORT DESIGN GUIDELINES

| ITEM   | $\alpha = 40^\circ$   | $\alpha = 45^\circ$ | $\alpha = 50^\circ$ | $\alpha = 55^\circ$ | $\alpha = 60^\circ$ |
|--|-----------------------|---------------------|---------------------|---------------------|---------------------|
| SLOPE ANGLE  |                       |                     |                     |                     |                     |
| Pit depth - feet                                       | 500                   | 500                 | 500                 | 500                 | 500                 |
| Bench height - feet                                    | 50                    | 50                  | 50                  | 50                  | 50                  |
| Bench width - feet                                     | 30                    | 30                  | 30                  | 30                  | 30                  |
| Bedding & joint<br>plane angle                         | $40^\circ$            | $40^\circ$          | $40^\circ$          | $40^\circ$          | $40^\circ$          |
| Number of benches                                      | 10                    | 10                  | 10                  | 10                  | 10                  |
| No. cables per<br>vertical section                     | 11                    | 11                  | 11                  | 11                  | 11                  |
| $\mu$  | 0.75                  | 0.75                | 0.75                | 0.75                | 0.75                |
| $\gamma$ , lbs/cu ft                                   | 165                   | 165                 | 165                 | 165                 | 165                 |
| Angle max, excess<br>shear stress $i^\circ$            | $37\frac{1}{2}^\circ$ | $40^\circ$          | $42^\circ$          | $44^\circ$          | $46^\circ$          |
| Optimum cable<br>angle $\Delta^\circ$                  | $-3^\circ$            | $-8^\circ$          | $-13^\circ$         | $-18^\circ$         | $-23^\circ$         |
| Angle $\Delta$ chosen                                  | $-3^\circ$            | $-8^\circ$          | $-10^\circ$         | $-10^\circ$         | $-10^\circ$         |
| Average excess shear<br>stress, $\tau_e$ , lbs/sq ft   | 41                    | 348                 | 840                 | 1490                | 2280                |
| Safety factor  | 1.5                   | 1.5                 | 1.5                 | 1.5                 | 1.5                 |
| Required shear<br>resistance, $\tau_p$ , lbs/<br>sq ft | 61.5                  | 522                 | 1260                | 2235                | 3420                |
| Cable type   | 270K                  | 270K                | 270K                | 270K                | 270K                |
|  | 12/0.5                | 12/0.5              | 12/0.5              | 12/0.5              | 12/0.5              |
| Cable design load,<br>lbs                              | 340,000               | 340,000             | 340,000             | 340,000             | 340,000             |
| Cable lateral<br>spacing, feet                         | 920                   | 114                 | 50                  | 29                  | 22                  |
| Cables length $n=1$ , ft                               | 80.5                  | 137.5               | 240                 | 337                 | 415                 |
| $n=2$  | 74.5                  | 126                 | 218                 | 306                 | 376                 |
| $n=3$  | 68.5                  | 114                 | 196                 | 274                 | 336                 |
| $n=4$  | 62.5                  | 102                 | 174                 | 242                 | 297                 |
| $n=5$  | 56.5                  | 90.5                | 152                 | 210                 | 257                 |
| $n=6$  | 50.5                  | 79                  | 130                 | 179                 | 218                 |
| $n=7$  | 44.5                  | 67                  | 108                 | 147                 | 178                 |
| $n=8$  | 38.5                  | 55                  | 86                  | 115                 | 138.5               |
| $n=9$  | 35                    | 43.5                | 64                  | 83.5                | 99                  |
| $n=10$   | 35                    | 35                  | 42                  | 52                  | 59.5                |
| $n=11$   | 35                    | 35                  | 35                  | 35                  | 35                  |
| Total footage  | ft 580                | 884.5               | 1445                | 1980.5              | 2409                |

## BENCH STABILITY ANALYSIS

1. Calculate the angle  $\varphi^0$  of the maximum excess shear stress

$\varphi$  is given either by equation (22) or by equation (26):

(a) if  $\varphi < \alpha$

$$\tan 2 \varphi = \frac{\{k_1 (\cos \alpha + \sin \alpha) + \mu k_1 (\sin \alpha - \cos \alpha) + k_2 (\sin \alpha + \mu \cos \alpha)\}}{\{k_1 (\sin \alpha - \cos \alpha) - \mu k_1 (\sin \alpha + \cos \alpha) + k_2 (\cos \alpha - \mu \sin \alpha)\}} \quad (22)$$

$$\text{where } k_1 = \frac{w\gamma}{2} \frac{\sin \alpha}{\{\cos (\alpha + \Delta) + \sin (\alpha + \Delta)\}} \quad \text{and } k_2 = \frac{a\gamma}{2 \sin \alpha}$$

or (b) if  $\varphi > \alpha$

$$\tan 2 \varphi = \frac{\{\mu w - a\mu \cot \alpha - a\}}{\{w - a \cot \alpha - a\mu\}} \quad (26)$$

Substituting  $w = 30$  ft,  $\gamma = 165$  lbs/cu ft,  $a = 50$  ft into both equations yields the following values of  $\varphi$ :

|           | $\alpha$  | $40^\circ$       | $45^\circ$       | $50^\circ$     | $55^\circ$     | $60^\circ$     |                              |
|-----------|-----------|------------------|------------------|----------------|----------------|----------------|------------------------------|
| From (22) | $\varphi$ | $43^\circ 30' *$ | $45^\circ 55' *$ | $47^\circ 54'$ | $49^\circ 30'$ | $50^\circ 36'$ | $\varphi$ must be $< \alpha$ |
| From (26) | $\varphi$ | $48^\circ 6'$    | $52^\circ 30'$   | $56^\circ 15'$ | $60^\circ 30'$ | $64^\circ 6'$  | $\varphi$ must be $> \alpha$ |

\* These results are not valid since  $\varphi > \alpha$ .

Thus it is seen that for  $\alpha = 40^\circ$  and  $\alpha = 45^\circ$  there is a unique solution for  $\varphi$  given by equation (26). However, for  $\alpha = 50^\circ$ ,  $55^\circ$  and  $60^\circ$  both solutions are valid. Hence in these cases we must calculate  $\tau_e$  for both solutions and design to resist the largest of the two maximum  $\tau_e$  values.

2. Calculate the maximum excess shear stress on plane at  $\varphi^0$

$\tau_e$  is given either by equation (19) or by equation (26):

(a) if  $\varphi < \alpha$

$$\tau_e = \{k_1 [\cos(\alpha+\varphi) + \sin(\alpha+\varphi)] + k_2 \sin(\alpha-\varphi)\} \{ \sin \varphi - \mu \cos \varphi \} \quad (19)$$

or (b) if  $\varphi > \alpha$

$$\tau_e = \frac{\gamma}{2} \{ \sin^2 \varphi (w-a \cot \alpha + a\mu) - \sin 2\varphi \left\{ \frac{\mu w}{2} - \frac{a\mu}{2} \cot \alpha - \frac{a}{2} \right\} - a\mu \} \quad (25)$$

Thus, substituting for valid values of  $\varphi$  and  $w = 30$  ft,  $\gamma = 165$  lbs/sq ft,  $\mu = 0.75$  and  $a = 50$  ft, we obtain:

| $\alpha^\circ$                | $40^\circ$    | $45^\circ$     | $50^\circ$     | $55^\circ$     | $60^\circ$     |
|-------------------------------|---------------|----------------|----------------|----------------|----------------|
| $\varphi$ from (22)           | Invalid       | Invalid        | $47^\circ 54'$ | $49^\circ 30'$ | $50^\circ 36'$ |
| $\tau_e$ from (19), lbs/sq ft | -             | -              | 324            | 414            | 496            |
| $\varphi$ from (26)           | $48^\circ 6'$ | $52^\circ 30'$ | $56^\circ 15'$ | $60^\circ 30'$ | $64^\circ 6'$  |
| $\tau_e$ from (25), lbs/sq ft | 250           | 504            | 685            | 1155           | 1520           |

i.e., in this example the maximum  $\tau_e$  values are always those given by equation (25).

3. Calculate the mesh tension  $T$  for idealized support (i.e. for safety factor of 1)

when  $\varphi > \alpha$ , from equation (28)

$$T = \frac{a \tau_e}{\{ \cos(\varphi+\Delta) + \mu \sin(\varphi+\Delta) \} \sin \varphi} \quad (28)$$

which yields the following values:

| $\alpha$ | $\varphi$      | $T$ lbs |
|----------|----------------|---------|
| 40       | $48^\circ 6'$  | 13,600  |
| 45       | $52^\circ 30'$ | 25,700  |
| 50       | $56^\circ 15'$ | 33,800  |
| 55       | $60^\circ 30'$ | 54,800  |
| 60       | $64^\circ 6'$  | 71,000  |

#### 4. Calculated idealized cross-sectional area per foot for the mesh

$$A_o = \frac{T}{\sigma_o}$$

if  $\sigma_o = 71,000$  psi, then:

| $\alpha$ | T lbs  | Area $A_o$ sq inch | Mesh style                    |
|----------|--------|--------------------|-------------------------------|
| 40       | 13,600 | 0.191              | 216-510 or 316-28 or 612-3/04 |
| 45       | 25,700 | 0.362              | 216-17                        |
| 50       | 33,800 | 0.476              | -                             |
| 55       | 54,800 | 0.772              | -                             |
| 60       | 71,000 | 1.00               | -                             |

For the requirements of the  $\alpha = 50, 55$  and  $60^\circ$  cases, the available meshes are not sufficiently strong to completely support the bench. For the  $40^\circ$  and  $45^\circ$  cases the available meshes will be heavy. Further, since they will be loading beams of fairly wide span it is almost certain, without further calculation, that it would not be possible to design a horizontal stringer to resist the bending moments imposed by these mesh loads. Hence it is not possible to completely support these benches for any of these cases. Let us therefore assume a horizontal stringer design which is practical and determine what mesh size would allow the full strength of this beam to be utilized and what safety factor for bench support is available.

#### 5. Horizontal Stringers

Assume that in all cases the horizontal stringer is a reinforced concrete beam size 18 in. x 18 in. containing 8 of No. 10 bars (10 sq inches); let  $d = 16.5$  inches; assume  $j = 7/8$  in.,  $f_s' = 33,000$ , and  $T_o = 71,000$ . The area of mesh steel required to be fully loaded in order to fully load this beam is

given by equation (38):

$$A_o = \frac{10 A_s f'_s j d}{\sigma_o l^2}$$

Thus, for the spans  $l$  required for the cable spacings, this yields the following values:

| $\alpha$ | $l$ ft | $A_o$                 | Mesh                       | Mesh chosen |
|----------|--------|-----------------------|----------------------------|-------------|
| 40       | 920    | $6.65 \times 10^{-7}$ | -                          | 22-1616     |
| 45       | 114    | $4.3 \times 10^{-5}$  | -                          | 22-1616     |
| 50       | 50     | $2.2 \times 10^{-3}$  | -                          | 22-1616     |
| 55       | 29     | $6.65 \times 10^{-2}$ | 33-99 or 44-77<br>or 66-55 | 66-55       |
| 60       | 20     | $1.16 \times 10^{-1}$ | 316-610 or 44-44           | 316-610     |

Due to the very large spans for the lower  $\alpha$  values, the area of steel required to fully load the beam is very small and is below that of a suitable available mesh. In these cases a very light-weight mesh has been chosen merely to control loose rock; it could not possibly provide significant bench support. For the  $55^\circ$  and  $60^\circ$  cases, available meshes would allow the beam to be fully loaded and would thus allow some small amount of bench support to be obtained. Let us now calculate the bench support safety factor for these cases.

#### 6. Bench support safety factor

Firstly, given the above mesh areas we can calculate the mesh tension,  $T$  lbs, from  $T = A_o \sigma_o$ . Then we can calculate the shear-resisting force  $\tau F$  mobilized by the mesh if the bench fails;

$$\tau F = \frac{T}{a} \{ \cos (\varphi + \Delta) + \mu \sin (\varphi + \Delta) \} \sin \varphi$$



and the safety factor  $S_{FB} = \frac{\tau_F}{\tau_e}$  where  $\tau_e$  is the previously calculated value of the maximum excess shear stress.

Hence,

| $\alpha$ | $A_o$                 | T lbs                | $T_F$                | $T_e$ | $S_{FB}$              |
|----------|-----------------------|----------------------|----------------------|-------|-----------------------|
| 40       | $6.5 \times 10^{-7}$  | $4.6 \times 10^{-2}$ | $8.5 \times 10^{-4}$ | 250   | $3.4 \times 10^{-6}$  |
| 45       | $4.3 \times 10^{-5}$  | 3.05                 | $6 \times 10^{-2}$   | 504   | $1.2 \times 10^{-4}$  |
| 50       | $2.2 \times 10^{-3}$  | 159                  | 326                  | 685   | $4.8 \times 10^{-3}$  |
| 55       | $6.65 \times 10^{-2}$ | 4760                 | 100.5                | 1155  | $8.7 \times 10^{-2}$  |
| 60       | $1.16 \times 10^{-1}$ | 8240                 | 177                  | 1520  | $1.16 \times 10^{-1}$ |

From this it is seen that for  $\alpha = 40, 45^\circ$  and  $50^\circ$  the bench support is completely negligible and the use of a light mesh, as suggested above, would be only to prevent small rocks from falling. For the cases of  $\alpha = 55^\circ$  and  $60^\circ$  a small portion of bench support is given, insofar as 8% and 11% of the bench could fail before overloading the horizontal stringer. However, it is doubtful that this degree of support would justify the cost of installation.

In conclusion it might therefore be said that the use of mesh as a means of bench support is, in the cases considered here, not justified. The laying of a light-weight mesh over the surface might be useful to help control loose rock. However, benches are normally designed to catch and thus help control loose rock; in consequence, the use of even a light-weight mesh for this purpose may not be justified. If, on the other hand, the slope were to be mined without benches (only, say, one transportation ramp), then it is thought that mesh would provide a very good method to control loose rock and, since the loads on the mesh without benches would be much less, might well give sufficient resistance to prevent failure of the ground not supported by the cable anchors.

Let us now consider the cost of the above installations, assuming, for this exercise at least, that mesh is installed to control the loose rock.

## COST ANALYSIS

Using the cost analysis figures derived in Part II, the costs of supporting these hypothetical slopes at  $\alpha = 40, 45, 50, 55$  and  $60^\circ$  have been calculated and are listed in the Table 4. Figure 29 shows the resulting cost per linear foot versus slope angle. It is seen from this figure that the cost per linear foot of the support system increases rapidly with increase of the slope angle.

However, if we assume that this pit would have been mined at an angle of  $37\frac{1}{2}^\circ$  had no support been used, then there will be a saving of costs through not excavating excess waste rock (in these cases, no allowance will be made for possible increased revenue from the ability to excavate deeper ore levels by reason of the increased slope angle). The amount of excavation saved is given approximately by:

$$V = \frac{Z^2}{2} \{ \cot \theta - \cot \alpha \} \text{ cu ft/linear foot,}$$

where  $\theta$  is the angle at which the slope would have been mined without use of support ( $\theta = 37\frac{1}{2}^\circ$  in this case). Table 5 gives the volumes saved and, assuming an excavation cost of \$0.34 per ton, lists the expenditure saved. It is also seen that this saving of expenditure increases rapidly with slope angle.

If we consider the profit per linear foot of support to be the difference between the expenses saved and the support costs, then Table 5 also lists this profit margin. Figure 30 shows the profit per linear foot versus slope angle. It is seen from this figure that there is some angle ( $\alpha = 53^\circ$  in this case) when the profit per linear foot is optimized, i.e. if a steeper slope angle were chosen the increased cost of the support system would outweigh the savings due to not excavating waste rock. Likewise, if a lower slope angle

TABLE 4: COST ESTIMATES

| ITEM, RATE, ETC.  | $\alpha = 40^\circ$  | \$                         | $\alpha = 45^\circ$  | \$                       | $\alpha = 50^\circ$  | \$                      | $\alpha = 55^\circ$  | \$                    | $\alpha = 60^\circ$   | \$                    |
|---|--|----------------------------|--|--------------------------|--|-------------------------|--|-----------------------|---|-----------------------|
| 1. SITE PREPARATION   | -  | -                          | -  | -                        | -  | -                       | -  | -                     | -   | -                     |
| 2. ANCHOR HOLE DRILLING<br>Diamond Drill HXsize<br>at \$11.00/ft of hole                      | 581 ft at 11.00  | 6,390                      | 884½ ft at 11.00   | 9,740                    | 1445 ft at 11.00   | 15,900                  | 1980½ ft at 11.00  | 21,800                | 2409 ft at 11.00  | 26,500                |
| 3. MESH choose 5-ft-wide mesh, allow 6-inch overlap. 10-ft overlap on ends.<br>Cost \$150/ton | Span = 920 ft<br>No. widths=230<br>sq ft/bench<br>= (100)x5x230<br>x 10 benches<br>22-616 mesh=12.92<br>lbs. per 100 sq.ft.<br>Total weight<br>= 74.5 tons at<br>\$150/ton | 11,200                     | Span = 114 ft<br>No. widths=29<br>sq ft/bench<br>= 100x5x29<br>x 10 benches<br>22-1616 mesh=12.92<br>lbs per 100 sq. ft.<br>Total weight<br>= 9.3 tons at<br>\$150/ton | 1,400                    | Span = 50 ft<br>No. widths=13<br>sq ft/bench<br>(100x5x13)<br>x 10 benches<br>22-1616 mesh=12.92<br>lbs per 100 sq ft.<br>Total weight<br>= 4.2 tons at<br>\$150/ton | 650                     | Span = 29 ft<br>No. widths=7<br>sq ft/bench<br>= (100x5x7)<br>x 10 benches<br>66-55 mesh=48.77<br>lbs per 100 sq.ft.<br>Total weight<br>= 8.5 tons at<br>\$150/ton | 1,300                 | Span = 22 ft<br>No. widths=6<br>sq ft/bench<br>= 100x5x6<br>x 10 benches<br>316-610 mesh = 451<br>lbs per 100 sq ft.<br>Total weight<br>= 6.75 tons at<br>\$150/ton | 1,000                 |
| Annealed wire, cost<br>at ¼% of mesh cost<br>(\$50 minimum)                                   |  | 550                        |  | 50                       |  | 50                      |  | 50                    |   | 50                    |
| Labour, 0.26 man-hours/ft of mesh to<br>be laced together                                     | footage=<br>100 x 230 x 10<br>Man-hours<br>= 59,800<br>29,900 hrs at \$2.50<br>29,900 hrs at \$3.10<br>15% overheads   | 74,800<br>92,500<br>25,100 | footage =<br>100 x 29 x 10<br>Man-hours<br>= 7,540<br>3,700 at \$2.50<br>3,700 at \$3.10<br>15% overheads  | 9,400<br>11,500<br>3,200 | footage =<br>100 x 13 x 10<br>Man-hours<br>= 3,380<br>1690 at \$2.50<br>1690 at \$3.10<br>15% overheads  | 4,200<br>5,250<br>1,400 | footage =<br>100 x 7 x 10<br>Man-hours<br>= 1,320<br>910 at \$2.50<br>910 at \$3.10<br>15% overheads   | 2,300<br>2,800<br>800 | footage =<br>100 x 6 x 10<br>Man-hours<br>= 1,560<br>780 at \$2.50<br>780 at \$3.10<br>15% overheads  | 1,950<br>2,400<br>650 |
| Equipment at 8 hrs/<br>panel at \$10/hour   | 10 panels, 8 hrs<br>at \$10/hr   | 800                        | 10 panels, 8 hrs<br>\$10/hour  | 800                      | 10 panels, 8 hrs<br>\$10 ,hour   | 800                     | 10 panels, 8 hrs<br>\$10/hour  | 800                   | 10 panels, 8 hrs<br>\$10/hour   | 800                   |
| 4. HORIZONTAL STRINGERS   |  |                            |  |                          |  |                         |  |                       |   |                       |
| Forming & Steel work<br>Steel at \$150/ton  | 8 No. 10 bars x<br>920ft at 4.31lbs/ft<br>x 11 stringers<br>= 18.7 tons<br>at \$150/ton  | 2,800                      | 8 No. 10 bars x<br>114ft at 4.31lbs/ft<br>x 11 stringers<br>= 1.17 tons<br>at \$150/ton  | 175                      | 8 No. 10 bars x<br>50ft at 4.31lbs,ft<br>x 11 stringers<br>= 0.5 tons<br>at \$150/ton  | 75                      | 8 No. 10 bars x<br>29ft at 4.31lbs ft<br>x 11 stringers<br>= 0.3 tons<br>at \$150/ton  | 45                    | 8 No. 10 bars x<br>22ft at 4.31lbs/ft<br>x 11 stringers<br>= 0.23 tons<br>at \$150/ton  | 35                    |
| Forming at \$1/ft   | 920 ft x 11  | 10,200                     | 114 ft x 11  | 1,250                    | 50 ft x 11   | 550                     | 29 ft x 11   | 320                   | 22 ft x 11  | 240                   |
| Labour 1.2 hrs/ft   | footage =920x11<br>hrs = 10,200 hrs<br>5,100 at \$2.50<br>5,100 at \$3.10<br>15% overhead  | 12,750<br>15,800<br>4,270  | footage =114x11<br>hours = 1,250<br>625 at \$2.50<br>625 at \$3.10<br>15% overhead   | 1,560<br>1,940<br>525    | footage =50x11<br>hours = 550 hrs<br>275 at \$2.50<br>275 at \$3.10<br>15% overhead  | 690<br>855<br>230       | footage =29x11<br>hours = 320 hrs<br>160 at \$2.50<br>160 at \$3.10<br>15% overhead  | 400<br>495<br>135     | footage = 22x11<br>hours = 240 hrs<br>120 at \$2.50<br>120 at \$3.10<br>15% overhead  | 300<br>340<br>95      |

- 93 -

Table 4, cont'd-

| ITEM, RATE, ETC.  | $\alpha = 40^\circ$   | \$                           | $\alpha = 45^\circ$   | \$                               | $\alpha = 50^\circ$   | \$                               | $\alpha = 55^\circ$   | \$                               | $\alpha = 60^\circ$   | \$                               |
|---|---|------------------------------|---|----------------------------------|---|----------------------------------|---|----------------------------------|---|----------------------------------|
| <b>4. HORIZONTAL STRINGERS</b><br>(cont'd)<br><br>Concrete at \$23 cu yd.<br><br>Labour 1.25 hrs/cu yd                  | Volume =<br>$\frac{3/2 \times 3/2 \times 920 \times 11}{27}$<br>= 834 cu yd<br>at \$23 cu yd                              | 19,200                       | Volume =<br>$\frac{3/2 \times 3/2 \times 114 \times 11}{27}$<br>= 104 cu yds<br>at \$23/cu yd                             | 2,360                            | Volume =<br>$\frac{3/2 \times 3/2 \times 50 \times 11}{27}$<br>= 46 cu yds<br>at \$23/cu yd                               | 1,060                            | Volume =<br>$\frac{3/2 \times 3/2 \times 29 \times 11}{27}$<br>= 27 cu yds<br>at \$23/cu yd                               | 620                              | Volume =<br>$\frac{3/2 \times 3/2 \times 22 \times 11}{27}$<br>= 20 cu yds<br>at \$23/cu yd                               | 460                              |
|   | hours = 1040<br>520 at \$2.50<br>520 at \$3.10<br>15% overhead  | 1,275<br>1,610<br>435        | hours = 130<br>65 at \$2.50<br>65 at \$3.10<br>15% overhead   | 160<br>200<br>55                 | hours = 56<br>28 at \$2.50<br>28 at \$3.10<br>15% overhead  | 70<br>90<br>20                   | hours = 34<br>17 at \$2.50<br>17 at \$3.10<br>15% overhead  | 45<br>55<br>15                   | hours = 25<br>13 at \$2.50<br>12 at \$3.10<br>15% overhead  | 35<br>40<br>10                   |
| <b>5. CABLE ANCHORS</b><br>\$40.50 per anchor plus 1.20/ft.<br>Labour 0.09 hrs/ft                                       | 11 anchors x \$40.50<br>581 ft at \$1.20/ft<br>hours = 52<br>26 at \$2.50<br>26 at \$3.10<br>15% overhead                 | 495<br>700<br>65<br>80<br>25 | 11 anchors x \$40.50<br>884½ ft at 1.20/ft<br>hours = 80<br>40 at \$2.50<br>40 at \$3.10<br>15% overhead                  | 495<br>1,060<br>100<br>125<br>35 | 11 anchors x \$40.50<br>1445 ft at 1.20 ft<br>hours = 130<br>65 at \$2.50<br>65 at \$3.10<br>15% overhead                 | 495<br>1,735<br>165<br>205<br>55 | 11 anchors x \$40.50<br>1980½ ft at 1.20 ft<br>hours = 178<br>89 at \$2.50<br>89 at \$3.10<br>15% overhead                | 495<br>2,380<br>225<br>275<br>75 | 11 anchors x \$40.50<br>2409 ft at 1.20/ft<br>hours = 217<br>109 at \$2.50<br>108 at \$3.10<br>15% overhead               | 495<br>2,900<br>270<br>335<br>90 |
| <b>6. GROUTING</b><br>6 man-hours/anchor<br><br>Cement \$5/hole<br>Equipment rental \$60/month assume 1 month per level | 11 anchors x 6 hrs = 66 hours<br>33 at \$2.50<br>33 at \$3.10<br>15% overhead<br>11 holes at \$5<br><br>11 levels at \$60 | 80<br>100<br>30<br>55<br>660 | 11 anchors x 6 hrs = 66 hours<br>33 at \$2.50<br>33 at \$3.10<br>15% overhead<br>11 holes at \$5<br><br>11 levels at \$60 | 80<br>100<br>30<br>55<br>660     | 11 anchors x 6 hrs = 66 hours<br>33 at \$2.50<br>33 at \$3.10<br>15% overhead<br>11 holes at \$5<br><br>11 levels at \$60 | 80<br>100<br>30<br>55<br>660     | 11 anchors x 6 hrs = 66 hours<br>33 at \$2.50<br>33 at \$3.10<br>15% overhead<br>11 holes at \$5<br><br>11 levels at \$60 | 80<br>100<br>30<br>55<br>660     | 11 anchors x 6 hrs = 66 hours<br>33 at \$2.50<br>33 at \$3.10<br>15% overhead<br>11 holes at \$5<br><br>11 levels at \$60 | 80<br>100<br>30<br>55<br>660     |
| <b>7. TENSIONING</b><br>3 man-hours/cable<br><br>Jack & pump rental at 75.00/week assume 1 week/level                   | 11 x 3 = 33 hrs<br>17 at \$2.50<br>16 at \$3.10<br>15% overhead<br><br>11 levels at \$75                                  | 40<br>50<br>15<br>800        | 11 x 3 = 33 hrs<br>17 at \$2.50<br>16 at \$3.10<br>15% overhead<br><br>11 levels at \$75                                  | 40<br>50<br>15<br>800            | 11 x 3 = 33 hrs<br>17 at \$2.50<br>16 at \$3.10<br>15% overhead<br><br>11 levels at \$75                                  | 40<br>50<br>15<br>800            | 11 x 3 = 33 hrs<br>17 at \$2.50<br>16 at \$3.10<br>15% overhead<br><br>11 levels at \$75                                  | 40<br>50<br>15<br>800            | 11 x 3 = 33 hrs<br>17 at \$2.50<br>16 at \$3.10<br>15% overhead<br><br>11 levels at \$75                                  | 40<br>50<br>15<br>800            |

- concluded

Table 4 (concluded)

| ITEM, RATE, ETC.                                     | $\alpha = 40^\circ$      | \$  | $\alpha = 45^\circ$       | \$  | $\alpha = 50^\circ$       | \$  | $\alpha = 55^\circ$        | \$  | $\alpha = 60^\circ$       | \$  |
|--|--------------------------|-----|---------------------------|-----|---------------------------|-----|----------------------------|-----|---------------------------|-----|
| 8. FINAL GROUTING<br>.035 man-hrs/ft                 | .035 x 581<br>= 20 hours |     | .035 x 884½<br>= 31 hours |     | .035 x 1445<br>= 51 hours |     | .035 x 1980½<br>= 70 hours |     | .035 x 2409<br>= 84 hours |     |
|  | 10 at \$2.50             | 25  | 16 at \$2.50              | 40  | 26 at \$2.50              | 65  | 35 at \$2.50               | 90  | 42 at \$2.50              | 105 |
|  | 10 at \$3.10             | 30  | 15 at \$3.10              | 45  | 25 at \$3.10              | 80  | 35 at \$3.10               | 110 | 42 at \$3.10              | 130 |
|  | 15% overhead             | 10  | 15% overhead              | 15  | 15% overhead              | 25  | 15% overhead               | 30  | 15% overhead              | 350 |
| grout at \$0.12/ft<br>(min \$5)                      | 581 x 0.12               | 70  | 884½ x 0.12               | 105 | 1445 x 0.12               | 175 | 1980½ x 0.12               | 240 | 2409 x 0.12               | 290 |
| Mixer & pump \$60/<br>month assume 1 month/<br>level | 11 levels                | 660 | 11 levels                 | 660 | 11 levels                 | 660 | 11 levels                  | 660 | 11 levels                 | 660 |
| TOTAL COST   | \$283,710                |     | \$48,330                  |     | \$37,380                  |     | \$38,390                   |     | \$42,030                  |     |
| COST per linear foot                                 | \$308                    |     | \$424                     |     | \$748                     |     | \$1324                     |     | \$1910                    |     |

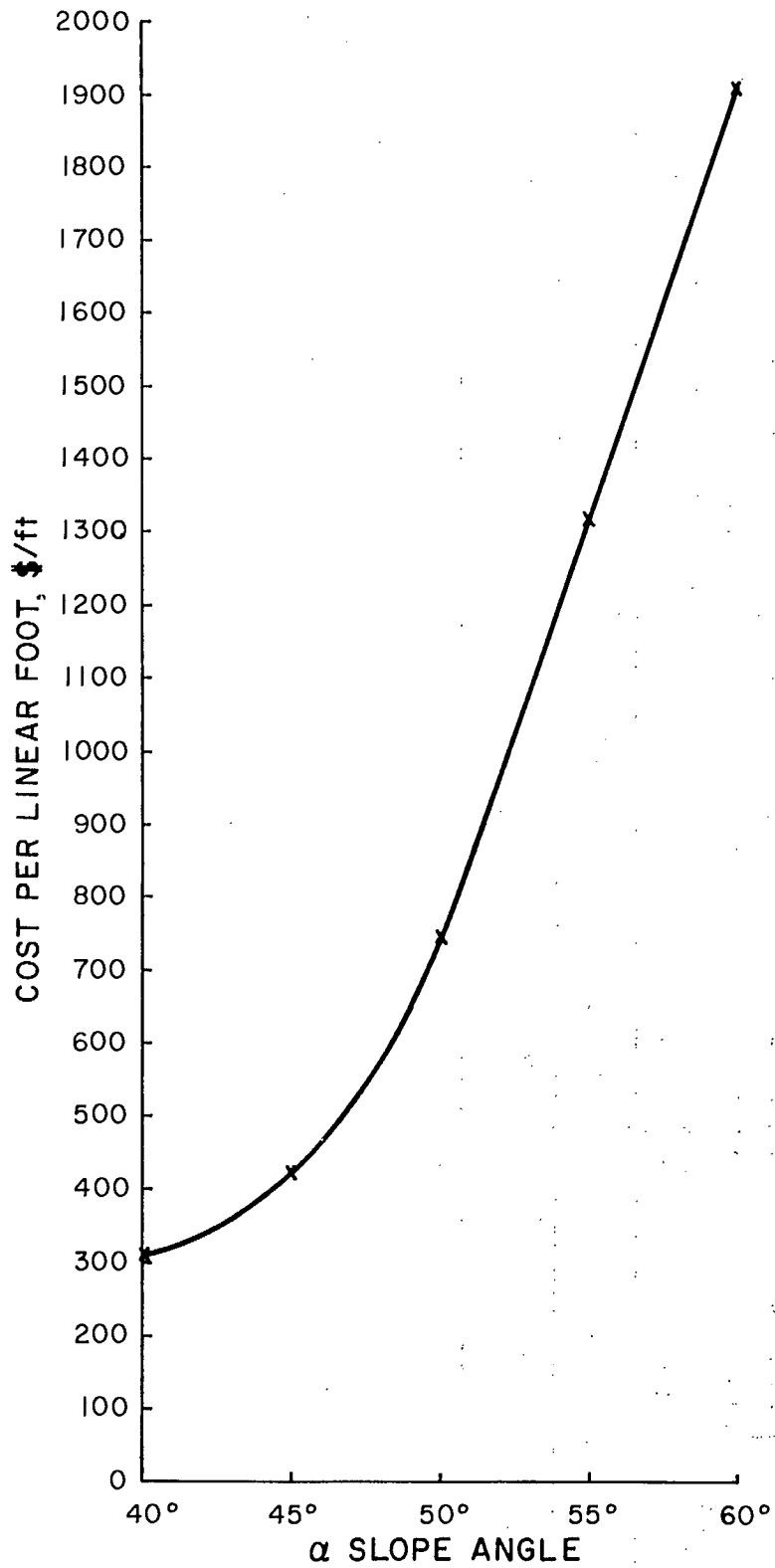

Figure 29. Support costs per linear foot versus slope angle.

TABLE 5: EXCAVATION SAVING AND PROFIT/LINEAR FOOT, BY USE OF SUPPORT

| SLOPE ANGLE<br>$\alpha^\circ$ | VOLUME EXCAVATION SAVED *<br>$V = \frac{z^2}{2} \{\cot \theta - \cot \alpha\}$ cu ft/linear ft | V cu<br>yds | V tons<br>at 2.23 tons/cu yd | EXCAVATION<br>SAVINGS AT<br>\$0.34/ton | SUPPORT COSTS<br>PER LINEAR FT | PROFIT PER<br>LINEAR FT |
|-------------------------------|--|-------------|------------------------------|--|--------------------------------|-------------------------|
| 40                            | 17,100   | 633         | 1410                         | \$495                                  | \$308                          | \$187                   |
| 45                            | 40,900   | 1515        | 3380                         | \$1180                                 | \$424                          | \$656                   |
| 50                            | 61,000   | 2260        | 5040                         | \$1765                                 | \$748                          | \$917                   |
| 55                            | 78,500   | 2910        | 6500                         | \$2280                                 | \$1324                         | \$964                   |
| 60                            | 93,700   | 3470        | 7750                         | \$2420                                 | \$1910                         | \$510                   |

\* Assumed that would be mined at  $\theta = 37\frac{1}{2}^\circ$  without support.



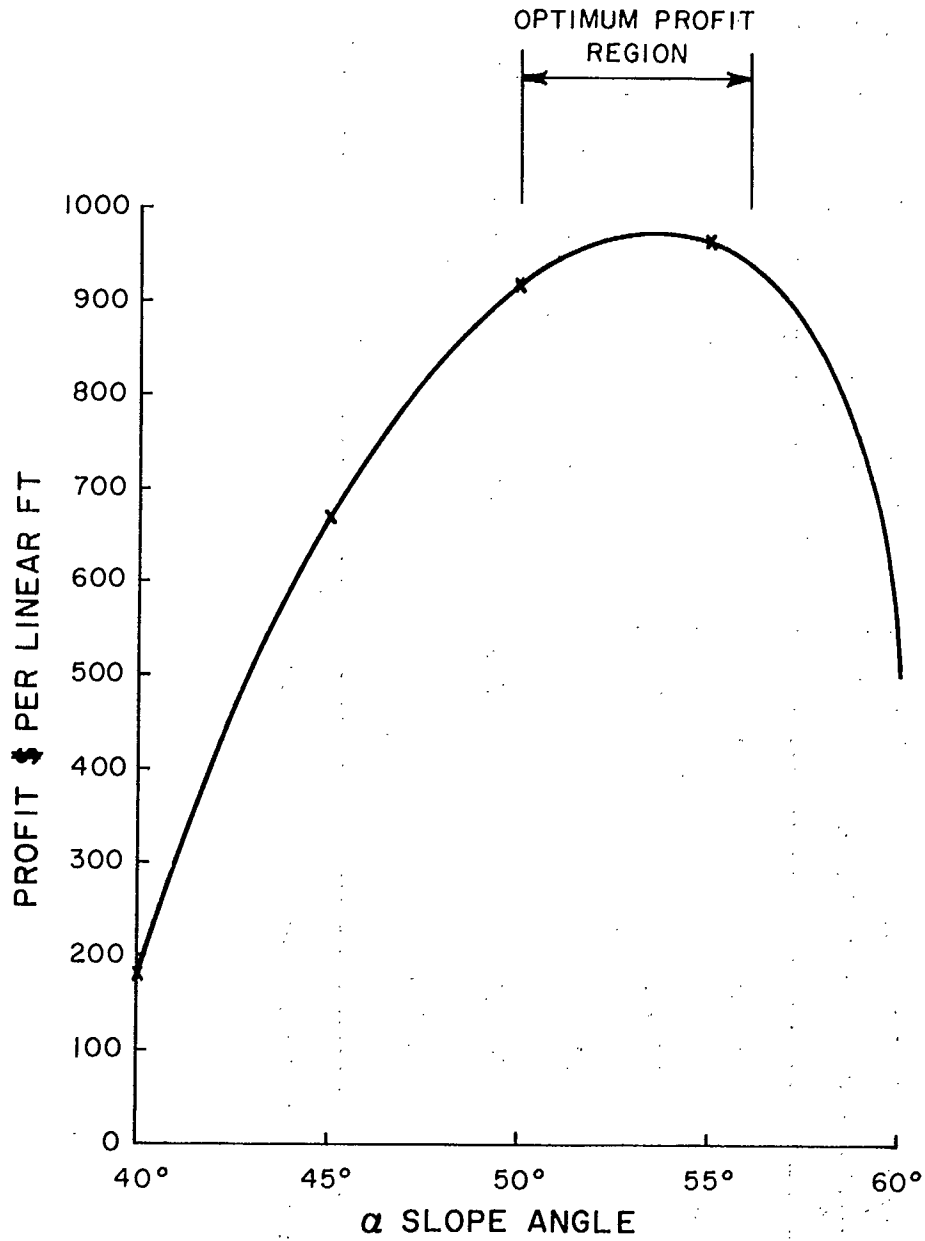

Figure 30. Profit per linear foot versus slope angle.

were chosen, the full benefits of waste rock excavation saving would not be fully realized. It would be logical, therefore, to choose the slope angle at which the profit is optimized, or as close to it as may be dictated by other considerations. Fortunately the profit is quite close to the optimum over a reasonably broad range of slope angles ( $50 \rightarrow 56^\circ$  in this case).

The above analysis has been carried out assuming that horizontal stringers and mesh have been used to control the loose surface rock unsupported by the deep cable anchors. If it is deemed that the bench design is adequate to control this loose rock, then the mesh and stringers need not be used. In such a case, Table 6 lists the overall support costs, the profits, etc. Figure 31 compares the profit margins for the cases of mesh and no mesh over the benches. The latter case optimizes at a slightly lower angle ( $52^\circ$ ) and yields considerably increased profits at all angles. At the optimum angles respectively, the profit is increased from approximately \$980 per ft with mesh to approximately \$1360 per ft without mesh.

TABLE 6: SUPPORT COSTS, EXCAVATION SAVINGS AND PROFIT PER LINEAR FOOT -  
IF NO MESH USED WITH SUPPORTS

| SLOPE ANGLE<br>$\alpha^\circ$ | TOTAL SUPPORT COST<br>(NO MESH OR STRINGERS) | COST/LINEAR FT<br>OF SUPPORTS | EXCAVATION SAVINGS,<br>\$/LINEAR FOOT | PROFIT PER<br>LINEAR FT<br>(NO MESH) | PROFIT PER<br>LINEAR FT<br>(WITH MESH) | INCREASED PROFIT<br>WHEN NO MESH<br>USED, \$/FT |
|-------------------------------|--|-------------------------------|---------------------------------------|--------------------------------------|--|---|
| 40°                           | \$10,380                                     | \$12                          | \$495                                 | \$483                                | \$187                                  | \$296   |
| 45°                           | \$14,250                                     | \$125                         | \$1180                                | \$1055                               | \$656                                  | \$399   |
| 50°                           | \$21,660                                     | \$433                         | \$1765                                | \$1332                               | \$917                                  | \$415   |
| 55°                           | \$28,210                                     | \$973                         | \$2280                                | \$1307                               | \$964                                  | \$443   |
| 60°                           | \$33,640                                     | \$1529                        | \$2420                                | \$890                                | \$510                                  | \$380   |

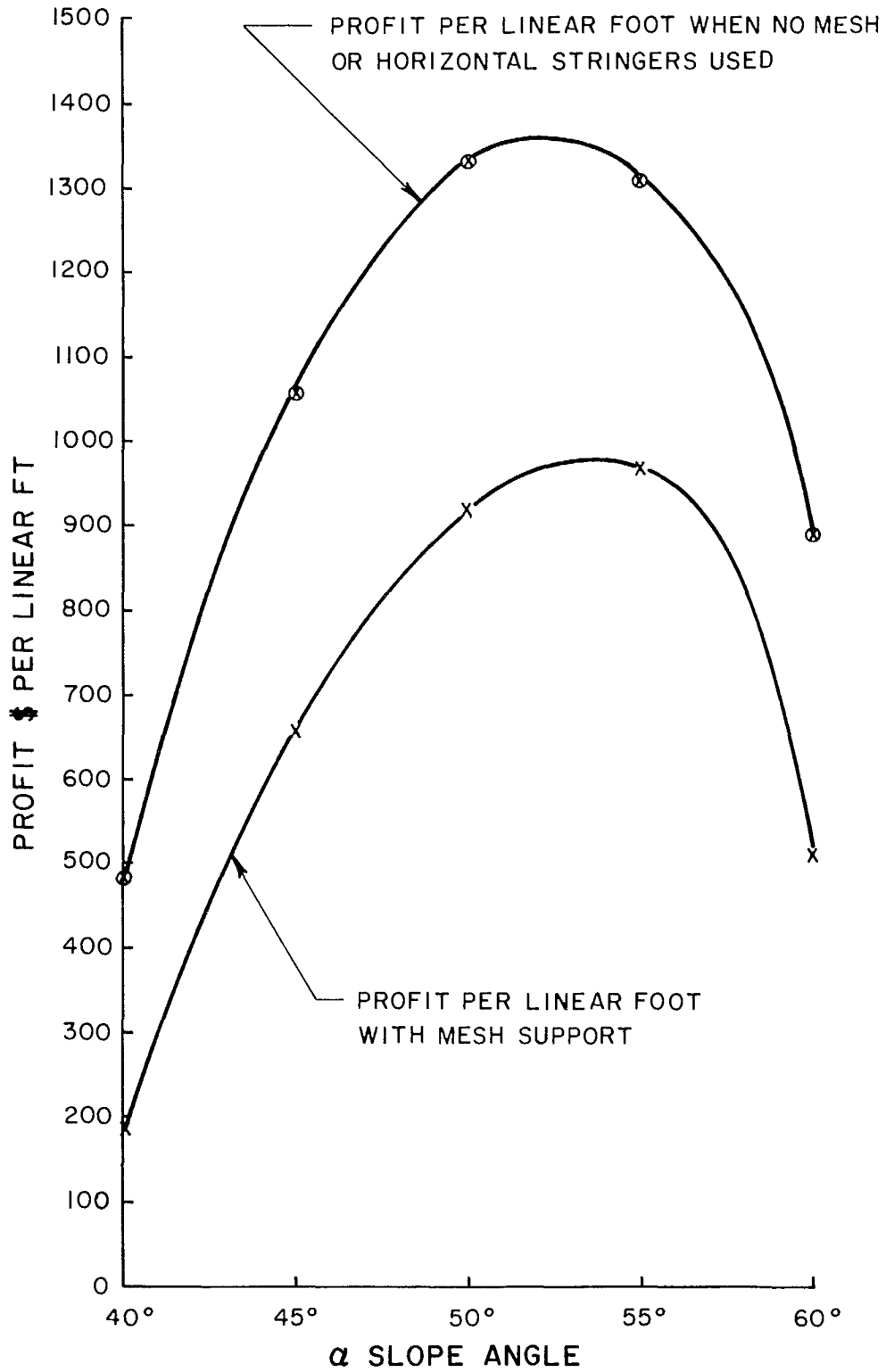

Figure 31. Comparison of profit per linear foot for cases with and without mesh - over the benches.

ACKNOWLEDGEMENTS

The work and report were completed with the assistance of many individuals on the staffs of the Company and the Mines Branch's Mining Research Centre. Mr. D. Dugmore produced the diagrams.

REFERENCES

1. Coates, D.F., Gyenge, M. and Fenton, C., Unpublished report.
2. Patton, F.D., "Multiple modes of shear failure in rock and related materials", Ph.D. Thesis, Univ. Illinois, 1966.
3. Jaeger, J.C., "The frictional properties of joints in rocks", Geofis. Pure et Appl., 1959, vol. 43, pp. 148-158.
4. Barron, K., "Fracture initiation in and ultimate failure of brittle rocks. Part I: Isotropic rocks", Mining Research Centre, Divisional report MR 68/75-LD, August 1968, Mines Branch, Ottawa.
5. Urquhart, L.D., O'Rourke, C.E. and Winter, G., "Design of concrete structures", McGraw-Hill Co. Ltd., New York, 6th Edition, 1958.
6. Barron, K., Gyenge, M. and Coates, D.F., Unpublished report.
7. ----- "Freysinnet post tensioning", Conenco Engineering Bulletin 67-3, Conenco Canada Ltd., 1967.
8. ----- "Stressteel post tensioning", Catalog No. SS-6, Conenco Canada Ltd., May 1965.
9. Coates, D.F., "Rock Mechanics Principles", Mines Branch Monograph 874 (revised 1967), Queen's Printer, Ottawa, 1967.

====

APPENDIX I: TENDON CHARACTERISTICSTABLE A1.1 - Tendon Characteristics

| QUALITY   | ASTM GRADE             |         |         |         | TYPE 270K              |         |         |         |
|---|------------------------|---------|---------|---------|------------------------|---------|---------|---------|
| Ultimate Strength of One Strand                                 | 36,000 Lb.             |         |         |         | 41,300 Lb.             |         |         |         |
| Nominal Steel Area of One Strand                                | .1438 In. <sup>2</sup> |         |         |         | .1531 In. <sup>2</sup> |         |         |         |
| Number of Strands   | 6                      | 8       | 9       | 12      | 6                      | 8       | 9       | 12      |
| Nominal Steel Area (In. <sup>2</sup> )                          | 0.86                   | 1.15    | 1.29    | 1.73    | 0.92                   | 1.22    | 1.38    | 1.84    |
| Ultimate Tendon Strength (Lb.)                                  | 216,000                | 288,000 | 324,000 | 432,000 | 247,800                | 330,400 | 371,700 | 495,600 |
| Maximum Initial *<br>Tensioning Load (Lb.)<br>(80% of Ultimate) | 172,800                | 230,400 | 259,200 | 345,600 | 198,240                | 264,320 | 297,360 | 396,480 |
| Tendon Weight<br>(Lb./Ft.)<br>(without enclosure)               | 2.96                   | 3.95    | 4.45    | 5.93    | 3.15                   | 4.20    | 4.73    | 6.30    |
| Recommended Hole I.D. (In.)                                     | 1-7/8                  | 2-1/4   | 2-1/4   | 2-5/8   | 1-7/8                  | 2-1/4   | 2-1/4   | 2-5/8   |

\* ● The magnitude of effective design forces attainable with post-tensioning tendons is a function of length and curvature of the tendons as well as the friction characteristics of the enclosure.

See calculation of elongations and pressures for Freyssinet post-tensioning cables (Reference 7).

APPENDIX II: BENCH STABILITY ANALYSIS: ANGLE  $\varphi^0$  AT WHICH THE EXCESS SHEAR STRESS  $\tau_e$  REACHES A MAXIMUM

From Equation (19) in the text:

$$\tau_e = \{k_1 [\cos(\alpha+\varphi) + \sin(\alpha+\varphi)] + k_2 \sin(\alpha-\varphi)\} \{\sin \varphi - \mu \cos \varphi\} \quad (A2.1)$$

$$\text{where } k_1 = w \frac{\gamma}{2} \frac{\sin \alpha}{\{\cos(\alpha+\Delta) + \sin(\alpha+\Delta)\}} \quad \text{and } k_2 = \frac{a\gamma}{2 \sin \alpha} \quad (A2.2)$$

Differentiating equation A2.1 and equating to zero gives:

$$\begin{aligned} \frac{\partial \tau_e}{\partial \varphi} &= \{k_1 [-\sin(\alpha+\varphi) + \cos(\alpha+\varphi)] - k_2 \cos(\alpha-\varphi)\} \{\sin \varphi - \mu \cos \varphi\} + \{k_1 [\cos(\alpha+\varphi) \\ &+ \sin(\alpha+\varphi)] + k_2 \sin(\alpha-\varphi)\} \{\cos \varphi + \mu \sin \varphi\} \\ &= -k_1 \sin \varphi \sin(\alpha+\varphi) + k_1 \sin \varphi \cos(\alpha+\varphi) - k_2 \sin \varphi \cos(\alpha-\varphi) \\ &+ \mu k_1 \cos \varphi \sin(\alpha+\varphi) - \mu k_2 \cos \varphi \cos(\alpha-\varphi) + \mu k_2 \cos \varphi \cos(\alpha-\varphi) \\ &+ k_1 \cos \varphi \cos(\alpha+\varphi) + k_1 \cos \varphi \sin(\alpha+\varphi) + k_2 \cos \varphi \sin(\alpha-\varphi) \\ &+ \mu k_1 \sin \varphi \cos(\alpha+\varphi) + \mu k_1 \sin \varphi \sin(\alpha+\varphi) + \mu k_2 \sin \varphi \sin(\alpha-\varphi) \\ &= k_1 \{\cos \varphi \cos(\alpha+\varphi) - \sin \varphi \sin(\alpha+\varphi)\} + k_1 \{\cos \varphi \sin(\alpha+\varphi) \\ &+ \sin \varphi \cos(\alpha+\varphi)\} + \mu k_1 \{\cos \varphi \sin(\alpha+\varphi) + \sin \varphi \cos(\alpha+\varphi)\} \\ &- \mu k_1 \{\cos \varphi \cos(\alpha+\varphi) - \sin \varphi \sin(\alpha+\varphi)\} - k_2 \{\sin \varphi \cos(\alpha-\varphi) \\ &- \cos \varphi \sin(\alpha-\varphi)\} + \mu k_2 \{\cos \varphi \cos(\alpha-\varphi) + \sin \varphi \sin(\alpha-\varphi)\} \\ &= k_1 \{\cos(2\varphi+\alpha)\} + k_1 \sin(2\varphi+\alpha) + \mu k_1 \sin(2\varphi+\alpha) - \mu k_1 \cos(2\varphi+\alpha) \\ &- k_2 \sin(2\varphi-\alpha) + \mu k_1 \cos(2\varphi-\alpha) \\ &= k_1 \{\cos 2\varphi \cos \alpha - \sin 2\varphi \sin \alpha\} + k_1 \{\sin 2\varphi \cos \alpha + \cos 2\varphi \sin \alpha\} \\ &+ \mu k_1 \{\sin 2\varphi \cos \alpha + \cos 2\varphi \sin \alpha\} - \mu k_1 \{\cos 2\varphi \cos \alpha - \sin 2\varphi \sin \alpha\} \end{aligned}$$

$$\begin{aligned}
& -k_2 \{ \sin 2\varphi \cos \alpha - \cos 2\varphi \sin \alpha \} + \mu k_2 \{ \cos 2\varphi \cos \alpha + \sin 2\varphi \sin \alpha \} \\
= & \cos 2\varphi \{ k_1 \cos \alpha + k_1 \sin \alpha + \mu k_1 \sin \alpha - \mu k_1 \cos \alpha + k_2 \sin \alpha + \mu k_2 \cos \alpha \} \\
& - \sin 2\varphi \{ k_1 \sin \alpha - k_1 \cos \alpha - \mu k_1 \cos \alpha - \mu k_1 \sin \alpha + k_2 \cos \alpha \\
& - \mu k_2 \sin \alpha \} \\
= & 0
\end{aligned}$$

$$\text{i.e. } \tan 2\varphi = \frac{\{k_1(\cos \alpha + \sin \alpha) + \mu k_1(\sin \alpha - \cos \alpha) + k_2(\sin \alpha + \mu \cos \alpha)\}}{\{k_1(\sin \alpha - \cos \alpha) - \mu k_1(\sin \alpha + \cos \alpha) + k_2(\cos \alpha - \mu \sin \alpha)\}}$$

Example: Suppose  $\alpha = 50^\circ$ ,  $a = 66$  ft.,  $w = 40$  ft.,  $\Delta = -10^\circ$ ,  $\mu = 0.8$ , and  $\gamma = 165$  lbs/cu ft;

$$\text{then } k_1 = \frac{165}{2} \frac{\sin(50) \times 40}{(\cos(40) + \sin(40))} = 1795$$

$$k_2 = \frac{66 \times 165}{2 \sin 50} = 7110$$

$$\begin{aligned}
\tan 2\varphi &= \frac{\{1795(1.409) + .8 \times 1795(.123) + 7110(.766 + .8 \times .643)\}}{\{1795(.123) - .8 \times 1795(1.409) + 7110(.643 - .8 \times .766)\}} \\
&= \frac{\{2530 + 176.5 + 9100\}}{\{221 - 2022 + 221\}} = \frac{11,806.5}{-1580} = -7.49
\end{aligned}$$

$$\begin{aligned}
\tan 180 - 2\varphi &= 7.49 & 180 - 2\varphi &= 82^\circ 24' & 2\varphi &= 97^\circ 36' \\
&&&&&& \varphi &= 48^\circ 48'
\end{aligned}$$

and when  $\varphi = 48^\circ 48'$ ,

then the maximum excess shear stress is:

$$\begin{aligned}
\tau_e &= \{1795(\cos 98^\circ 48' + \sin 98^\circ 48') + 7110 \sin(50 - 48^\circ 48')\} (\sin 48^\circ 48' - .8 \cos 48^\circ 48') \\
&= \{1795(-.153 + .988) + 7110 .021\} \{.752 - .8 \times .659\} \\
&= \{1498 + 149\} \{.224\} = 369 = 370 \text{ lbs/sq ft.}
\end{aligned}$$



## APPENDIX III: DATA ON WELDED WIRE FABRIC\*

TABLE A3.1

### STANDARD STYLES OF WELDED FABRIC

Showing Styles, Weights, Spacing and Gauges of Wires, and Sectional Areas

For convenience in listing styles the spacing of the wires is shown to the left of the dash and the gauge of the wires, to the right.

| Style    | Weight per 100 Square Feet Based on Net Width of 60" | Spacing of Wires in Inches |        | Steel Wire Gauge No. |        | Sect. Areas Square Inches per Foot |        | Style     | Weight per 100 Square Feet Based on Net Width of 60" | Spacing of Wires in Inches |        | Steel Wire Gauge No. |        | Sect. Areas Square Inches per Foot |        |
|----------|--|----------------------------|--------|----------------------|--------|------------------------------------|--------|-----------|--|----------------------------|--------|----------------------|--------|------------------------------------|--------|
|          |  | Longit.                    | Trans. | Longit.              | Trans. | Longit.                            | Trans. |           |  | Longit.                    | Trans. | Longit.              | Trans. | Longit.                            | Trans. |
| 22-1616* | 13   | 2                          | 2      | 16                   | 16     | .018                               | .018   | 412-1212* | 13   | 4                          | 12     | 12                   | 12     | .026                               | .009   |
| 22-1414* | 21   | 2                          | 2      | 14                   | 14     | .030                               | .030   | 412-1112* | 16   | 4                          | 12     | 11                   | 12     | .034                               | .009   |
| 22-1313* | 28   | 2                          | 2      | 13                   | 13     | .039                               | .039   | 412-1012  | 19   | 4                          | 12     | 10                   | 12     | .043                               | .009   |
| 22-1212* | 37   | 2                          | 2      | 12                   | 12     | .052                               | .052   | 412-912   | 22   | 4                          | 12     | 9                    | 12     | .052                               | .009   |
| 22-1111* | 48   | 2                          | 2      | 11                   | 11     | .068                               | .068   | 412-812   | 25   | 4                          | 12     | 8                    | 12     | .062                               | .009   |
| 22-1010  | 60   | 2                          | 2      | 10                   | 10     | .086                               | .086   | 412-711   | 31   | 4                          | 12     | 7                    | 11     | .074                               | .011   |
| 24-1414* | 16   | 2                          | 4      | 14                   | 14     | .030                               | .015   | 412-610   | 36   | 4                          | 12     | 6                    | 10     | .087                               | .014   |
| 24-1314* | 19   | 2                          | 4      | 13                   | 14     | .039                               | .015   | 412-510   | 42   | 4                          | 12     | 5                    | 10     | .101                               | .014   |
| 24-1212* | 28   | 2                          | 4      | 12                   | 12     | .052                               | .026   | 412-57    | 45   | 4                          | 12     | 5                    | 7      | .101                               | .025   |
| 212-38   | 105  | 2                          | 12     | 3                    | 8      | .280                               | .021   | 412-49    | 49   | 4                          | 12     | 4                    | 9      | .120                               | .017   |
| 212-06   | 166  | 2                          | 12     | 0                    | 6      | .443                               | .029   | 416-1012  | 18   | 4                          | 16     | 10                   | 12     | .043                               | .007   |
| 216-812  | 46   | 2                          | 16     | 8                    | 12     | .124                               | .007   | 416-912   | 21   | 4                          | 16     | 9                    | 12     | .052                               | .007   |
| 216-711  | 55   | 2                          | 16     | 7                    | 11     | .148                               | .008   | 416-812   | 25   | 4                          | 16     | 8                    | 12     | .062                               | .007   |
| 216-610  | 65   | 2                          | 16     | 6                    | 10     | .174                               | .011   | 416-711   | 30   | 4                          | 16     | 7                    | 11     | .074                               | .009   |
| 216-510  | 75   | 2                          | 16     | 5                    | 10     | .202                               | .011   | 416-610   | 35   | 4                          | 16     | 6                    | 10     | .087                               | .011   |
| 216-49   | 89   | 2                          | 16     | 4                    | 9      | .239                               | .013   | 416-510   | 40   | 4                          | 16     | 5                    | 10     | .101                               | .011   |
| 216-38   | 104  | 2                          | 16     | 3                    | 8      | .280                               | .015   | 416-49    | 48   | 4                          | 16     | 4                    | 9      | .120                               | .013   |
| 216-28   | 119  | 2                          | 16     | 2                    | 8      | .325                               | .015   | 416-38    | 56   | 4                          | 16     | 3                    | 8      | .140                               | .015   |
| 216-17   | 139  | 2                          | 16     | 1                    | 7      | .377                               | .018   | 416-28    | 64   | 4                          | 16     | 2                    | 8      | .162                               | .015   |
| 33-1414* | 14   | 3                          | 3      | 14                   | 14     | .020                               | .020   | 66-1212*  | 13   | 6                          | 6      | 12                   | 12     | .017                               | .017   |
| 33-1212* | 25   | 3                          | 3      | 12                   | 12     | .035                               | .035   | 66-1010   | 21   | 6                          | 6      | 10                   | 10     | .029                               | .029   |
| 33-1111* | 32   | 3                          | 3      | 11                   | 11     | .046                               | .046   | 66-99     | 25   | 6                          | 6      | 9                    | 9      | .035                               | .035   |
| 33-1010  | 41   | 3                          | 3      | 10                   | 10     | .057                               | .057   | 66-88     | 30   | 6                          | 6      | 8                    | 8      | .041                               | .041   |
| 33-99    | 49   | 3                          | 3      | 9                    | 9      | .069                               | .069   | 66-77     | 36   | 6                          | 6      | 7                    | 7      | .049                               | .049   |
| 33-88    | 58   | 3                          | 3      | 8                    | 8      | .082                               | .082   | 66-66     | 42   | 6                          | 6      | 6                    | 6      | .058                               | .058   |
| 316-812  | 32   | 3                          | 16     | 8                    | 12     | .082                               | .007   | 66-55     | 49   | 6                          | 6      | 5                    | 5      | .067                               | .067   |
| 316-711  | 38   | 3                          | 16     | 7                    | 11     | .098                               | .009   | 66-46     | 50   | 6                          | 6      | 4                    | 6      | .080                               | .058   |
| 316-610  | 45   | 3                          | 16     | 6                    | 10     | .116                               | .011   | 66-44     | 58   | 6                          | 6      | 4                    | 4      | .080                               | .080   |
| 316-510  | 52   | 3                          | 16     | 5                    | 10     | .135                               | .011   | 66-33     | 68   | 6                          | 6      | 3                    | 3      | .093                               | .093   |
| 316-49   | 61   | 3                          | 16     | 4                    | 9      | .159                               | .013   | 66-22     | 78   | 6                          | 6      | 2                    | 2      | .108                               | .108   |
| 316-38   | 72   | 3                          | 16     | 3                    | 8      | .187                               | .015   | 66-11     | 91   | 6                          | 6      | 1                    | 1      | .126                               | .126   |
| 316-28   | 83   | 3                          | 16     | 2                    | 8      | .216                               | .015   | 66-00     | 107  | 6                          | 6      | 0                    | 0      | .148                               | .148   |
| 316-17   | 96   | 3                          | 16     | 1                    | 7      | .252                               | .018   | 612-77    | 27   | 6                          | 12     | 7                    | 7      | .049                               | .025   |
| 316-06   | 113  | 3                          | 16     | 0                    | 6      | .295                               | .022   | 612-66    | 32   | 6                          | 12     | 6                    | 6      | .058                               | .029   |
| 44-1414* | 11   | 4                          | 4      | 14                   | 14     | .015                               | .015   | 612-55    | 37   | 6                          | 12     | 5                    | 5      | .067                               | .034   |
| 44-1313* | 14   | 4                          | 4      | 13                   | 13     | .020                               | .020   | 612-44    | 44   | 6                          | 12     | 4                    | 4      | .080                               | .040   |
| 44-1212* | 19   | 4                          | 4      | 12                   | 12     | .026                               | .026   | 612-33    | 51   | 6                          | 12     | 3                    | 3      | .093                               | .047   |
| 44-1010  | 31   | 4                          | 4      | 10                   | 10     | .043                               | .043   | 612-25    | 52   | 6                          | 12     | 2                    | 5      | .108                               | .034   |
| 44-88    | 44   | 4                          | 4      | 8                    | 8      | .062                               | .062   | 612-22    | 59   | 6                          | 12     | 2                    | 2      | .108                               | .054   |
| 44-77    | 53   | 4                          | 4      | 7                    | 7      | .074                               | .074   | 612-17    | 56   | 6                          | 12     | 1                    | 7      | .126                               | .025   |
| 44-66    | 62   | 4                          | 4      | 6                    | 6      | .087                               | .087   | 612-14    | 61   | 6                          | 12     | 1                    | 4      | .126                               | .040   |
| 44-44    | 85   | 4                          | 4      | 4                    | 4      | .120                               | .120   | 612-11    | 69   | 6                          | 12     | 1                    | 1      | .126                               | .063   |
| 48-1313* | 11   | 4                          | 8      | 13                   | 13     | .020                               | .010   | 612-06    | 65   | 6                          | 12     | 0                    | 6      | .148                               | .029   |
| 48-1214* | 12   | 4                          | 8      | 12                   | 14     | .026                               | .008   | 612-03    | 72   | 6                          | 12     | 0                    | 3      | .148                               | .047   |
| 48-1212* | 14   | 4                          | 8      | 12                   | 12     | .026                               | .013   | 612-00    | 81   | 6                          | 12     | 0                    | 0      | .148                               | .074   |
| 48-1112* | 17   | 4                          | 8      | 11                   | 12     | .034                               | .013   | 612-2/04  | 78   | 6                          | 12     | 2/0                  | 4      | .172                               | .040   |
| 48-1012  | 20   | 4                          | 8      | 10                   | 12     | .043                               | .013   | 612-3/04  | 91   | 6                          | 12     | 3/0                  | 4      | .206                               | .040   |
| 48-912   | 23   | 4                          | 8      | 9                    | 12     | .052                               | .013   |           |  |                            |        |                      |        |                                    |        |
| 48-812   | 27   | 4                          | 8      | 8                    | 12     | .062                               | .013   |           |  |                            |        |                      |        |                                    |        |
| 48-711   | 33   | 4                          | 8      | 7                    | 11     | .074                               | .017   |           |  |                            |        |                      |        |                                    |        |

NOTE: Styles Marked (\*) can be furnished GALVANIZED only.

\* From "Design Manual Welded Wire Fabric", Wire Reinforcement Institute Inc., Washington, D.C., 1957.

TABLE A3.2

## TABLES FOR ESTIMATING WEIGHT OF WELDED WIRE FABRIC

For all styles having uniform spacings and gauges of members

| Approximate Weights in Pounds per 100 Square Feet — Based on 60" width c. to c. of outside longitudinal wires. |                                |        |        |        |        |       |       |     |
|--|--------------------------------|--------|--------|--------|--------|-------|-------|-----|
| Steel Wire<br>Gauge<br>Numbers   | Weight of Longitudinal Members |        |        |        |        |       |       |     |
|  | Spacing                        |        |        |        |        |       |       |     |
|  | 2"                             | 3"     | 4"     | 6"     | 8"     | 10"   | 12"   | 16" |
| 000000   | 397.05                         | 268.97 | 201.93 | 110.89 | 108.87 | 89.66 | 76.85 |     |
| 000000   | 352.22                         | 238.60 | 181.79 | 124.98 | 96.58  | 79.53 | 68.17 |     |
| 00000  | 306.47                         | 207.61 | 158.18 | 108.75 | 84.03  | 69.20 | 59.31 |     |
| 0000   | 256.43                         | 173.71 | 132.35 | 90.99  | 70.31  | 57.90 | 49.63 |     |
| 000  | 217.31                         | 147.21 | 112.16 | 77.11  | 59.59  | 49.07 | 42.06 |     |
| 00   | 181.16                         | 122.72 | 93.50  | 64.28  | 49.67  | 40.91 | 35.06 |     |
| 0  | 155.37                         | 105.25 | 80.19  | 55.13  | 42.60  | 35.08 | 30.07 |     |
| 1  | 132.43                         | 89.71  | 68.35  | 46.99  | 36.31  | 29.90 | 25.63 |     |
| 2  | 113.96                         | 77.20  | 58.82  | 40.44  | 31.25  | 25.73 | 22.06 |     |
| ¼"   | 103.33                         | 70.00  | 53.33  | 36.67  | 28.33  | 23.33 | 20.00 |     |
| 3  | 98.21                          | 66.53  | 50.69  | 34.85  | 26.93  | 22.18 | 19.01 |     |
| 4  | 83.95                          | 56.87  | 43.33  | 29.79  | 23.02  | 18.96 | 16.25 |     |
| 5  | 70.87                          | 48.01  | 36.58  | 25.15  | 19.43  | 16.00 | 13.72 |     |
| 6  | 60.96                          | 41.25  | 31.46  | 21.63  | 16.71  | 13.76 | 11.80 |     |
| 7  | 51.81                          | 35.10  | 26.74  | 18.38  | 14.21  | 11.70 | 10.03 |     |
| 8  | 43.40                          | 29.40  | 22.40  | 15.40  | 11.90  | 9.80  | 8.40  |     |
| 9  | 36.37                          | 24.64  | 18.77  | 12.91  | 9.97   | 8.21  | 7.04  |     |
| 10   | 30.14                          | 20.42  | 15.56  | 10.69  | 8.26   | 6.81  | 5.83  |     |
| 11   | 24.01                          | 16.27  | 12.39  | 8.52   | 6.58   | 5.42  | 4.65  |     |
| 12   | 18.41                          | 12.47  | 9.50   | 6.53   | 5.05   | 4.16  | 3.56  |     |
| 13   | 13.84                          | 9.38   | 7.15   | 4.91   | 3.80   | 3.13  | 2.68  |     |
| 14   | 10.58                          | 7.17   | 5.46   | 3.76   | 2.90   | 2.39  | 2.05  |     |
| 15   | 8.57                           | 5.81   | 4.43   | 3.04   | 2.35   | 1.94  | 1.66  |     |
| 16   | 6.46                           | 4.38   | 3.33   | 2.29   | 1.77   | 1.46  | 1.25  |     |

| Steel Wire<br>Gauge<br>Numbers | Weight of Transverse Members |        |        |       |       |       |       |       |
|--------------------------------|------------------------------|--------|--------|-------|-------|-------|-------|-------|
|                                | Spacing                      |        |        |       |       |       |       |       |
|                                | 2"                           | 3"     | 4"     | 6"    | 8"    | 10"   | 12"   | 16"   |
| 0000                           | 256.43                       | 170.95 | 128.22 | 85.18 | 64.11 | 51.29 | 42.74 | 32.05 |
| 000                            | 217.31                       | 144.87 | 108.66 | 72.44 | 54.33 | 43.46 | 36.22 | 27.16 |
| 00                             | 181.16                       | 120.78 | 90.58  | 60.39 | 45.29 | 36.23 | 30.19 | 22.65 |
| 0                              | 155.37                       | 103.58 | 77.69  | 51.79 | 38.84 | 31.07 | 25.90 | 19.42 |
| 1                              | 132.43                       | 88.29  | 66.22  | 44.14 | 33.11 | 26.49 | 22.07 | 16.55 |
| 2                              | 113.96                       | 75.97  | 56.98  | 37.99 | 28.49 | 22.79 | 18.99 | 14.24 |
| ¼"                             | 103.33                       | 68.89  | 51.67  | 34.44 | 25.83 | 20.67 | 17.22 | 12.92 |
| 3                              | 98.21                        | 65.47  | 49.10  | 32.74 | 24.55 | 19.64 | 16.37 | 12.28 |
| 4                              | 83.95                        | 55.97  | 41.97  | 27.98 | 20.99 | 16.79 | 13.99 | 10.49 |
| 5                              | 70.87                        | 47.24  | 35.43  | 23.62 | 17.72 | 14.17 | 11.81 | 8.86  |
| 6                              | 60.96                        | 40.64  | 30.48  | 20.32 | 15.24 | 12.19 | 10.16 | 7.62  |
| 7                              | 51.81                        | 34.54  | 25.90  | 17.27 | 12.95 | 10.36 | 8.63  | 6.48  |
| 8                              | 43.40                        | 28.93  | 21.70  | 14.47 | 10.85 | 8.68  | 7.23  | 5.43  |
| 9                              | 36.37                        | 24.25  | 18.18  | 12.12 | 9.09  | 7.27  | 6.06  | 4.55  |
| 10                             | 30.14                        | 20.09  | 15.07  | 10.05 | 7.53  | 6.03  | 5.02  | 3.77  |
| 11                             | 24.01                        | 16.01  | 12.01  | 8.00  | 6.00  | 4.80  | 4.00  | 3.00  |
| 12                             | 18.41                        | 12.27  | 9.20   | 6.14  | 4.60  | 3.68  | 3.07  | 2.30  |
| 13                             | 13.84                        | 9.23   | 6.92   | 4.61  | 3.46  | 2.77  | 2.31  | 1.73  |
| 14                             | 10.58                        | 7.06   | 5.29   | 3.53  | 2.65  | 2.12  | 1.76  | 1.32  |
| 15                             | 8.57                         | 5.72   | 4.29   | 2.86  | 2.14  | 1.71  | 1.43  | 1.07  |
| 16                             | 6.46                         | 4.31   | 3.23   | 2.15  | 1.62  | 1.29  | 1.08  | .81   |

TABLE A3.3

## SECTIONAL AREAS OF WELDED WIRE FABRIC

(Area in square inches per foot of width for various spacings of wire)

| Steel Wire<br>Gauge<br>Numbers | Wire               |                          | Weight<br>Pounds<br>per<br>Foot | Center to Center Spacing, in Inches |      |      |      |      |      |      |      |
|--------------------------------|--------------------|--------------------------|---------------------------------|-------------------------------------|------|------|------|------|------|------|------|
|                                | Diameter<br>Inches | Area<br>Square<br>Inches |                                 | 2                                   | 3    | 4    | 6    | 8    | 10   | 12   | 16   |
| 0000000                        | .4900              | .18857                   | .6104                           | 1.131                               | .754 | .566 | .377 | .283 | .226 | .189 | .141 |
| 000000                         | .4615              | .16728                   | .5681                           | 1.004                               | .669 | .502 | .335 | .251 | .201 | .167 | .125 |
| 00000                          | .4305              | .14556                   | .4943                           | .873                                | .582 | .437 | .291 | .218 | .175 | .146 | .109 |
| 0000                           | .3938              | .12180                   | .4136                           | .731                                | .487 | .365 | .244 | .183 | .146 | .122 | .091 |
| 000                            | .3625              | .10321                   | .3505                           | .619                                | .413 | .310 | .206 | .155 | .124 | .103 | .077 |
| 00                             | .3310              | .086049                  | .2922                           | .516                                | .344 | .258 | .172 | .129 | .103 | .086 | .065 |
| 0                              | .3065              | .073782                  | .2506                           | .443                                | .295 | .221 | .148 | .111 | .089 | .074 | .055 |
| 1                              | .2830              | .062902                  | .2136                           | .377                                | .252 | .189 | .126 | .094 | .075 | .063 | .047 |
| 2                              | .2625              | .054119                  | .1838                           | .325                                | .216 | .162 | .108 | .081 | .065 | .054 | .041 |
| ¼"                             | .2500              | .049087                  | .1667                           | .295                                | .196 | .147 | .098 | .074 | .059 | .049 | .037 |
| 3                              | .2437              | .046645                  | .1584                           | .280                                | .187 | .140 | .093 | .070 | .056 | .047 | .035 |
| 4                              | .2253              | .039867                  | .1354                           | .239                                | .159 | .120 | .080 | .060 | .048 | .040 | .030 |
| 5                              | .2070              | .033654                  | .1143                           | .202                                | .135 | .101 | .067 | .050 | .040 | .034 | .025 |
| 6                              | .1920              | .028953                  | .09832                          | .174                                | .116 | .087 | .058 | .043 | .035 | .029 | .022 |
| 7                              | .1770              | .024606                  | .08356                          | .148                                | .098 | .074 | .049 | .037 | .030 | .025 | .018 |
| 8                              | .1620              | .020612                  | .07000                          | .124                                | .082 | .062 | .041 | .031 | .025 | .021 | .015 |
| 9                              | .1483              | .017273                  | .05866                          | .104                                | .069 | .052 | .035 | .026 | .021 | .017 | .013 |
| 10                             | .1350              | .014314                  | .04861                          | .086                                | .057 | .043 | .029 | .021 | .017 | .014 | .011 |
| 11                             | .1205              | .011404                  | .03873                          | .068                                | .046 | .034 | .023 | .017 | .014 | .011 | .009 |
| 12                             | .1055              | .0087417                 | .02969                          | .052                                | .035 | .026 | .017 | .013 | .010 | .009 | .007 |
| 13                             | .0915              | .0065755                 | .02233                          | .039                                | .026 | .020 | .013 | .010 | .008 | .007 | .005 |
| 14                             | .0800              | .0050266                 | .01707                          | .030                                | .020 | .015 | .010 | .008 | .006 | .005 | .004 |
| 15                             | .0720              | .0040715                 | .01383                          | .024                                | .016 | .012 | .008 | .006 | .005 | .004 | .003 |
| 16                             | .0625              | .0030680                 | .01042                          | .018                                | .012 | .009 | .006 | .005 | .004 | .003 | .002 |

NOTE: This table does not necessarily indicate mill limitations.

For the sectional areas of half-gauge wires it is sufficiently accurate to interpolate between figures shown in the above table.

APPENDIX IV: STANDARD BARS \*

Table A4.1: Designations, Areas, Perimeters, and Weights of Standard Bars

| Bar designation* | Diameter, in.                 | Cross-sectional area, sq in. | Perimeter, in. | Unit wt per ft, lb |
|------------------|-------------------------------|------------------------------|----------------|--------------------|
| No. 2            | $\frac{1}{4} = 0.250$         | 0.05                         | 0.79           | 0.167              |
| No. 3            | $\frac{3}{8} = 0.375$         | 0.11                         | 1.18           | 0.376              |
| No. 4            | $\frac{1}{2} = 0.500$         | 0.20                         | 1.57           | 0.668              |
| No. 5            | $\frac{5}{8} = 0.625$         | 0.31                         | 1.96           | 1.043              |
| No. 6            | $\frac{3}{4} = 0.750$         | 0.44                         | 2.36           | 1.502              |
| No. 7            | $\frac{7}{8} = 0.875$         | 0.60                         | 2.75           | 2.044              |
| No. 8            | 1 = 1.000                     | 0.79                         | 3.14           | 2.670              |
| No. 9            | $1\frac{1}{8}\dagger = 1.128$ | 1.00                         | 3.54           | 3.400              |
| No. 10           | $1\frac{1}{4}\dagger = 1.270$ | 1.27                         | 3.99           | 4.303              |
| No. 11           | $1\frac{3}{8}\dagger = 1.410$ | 1.56                         | 4.43           | 5.313              |

\* Based on the number of eighths of an inch included in the nominal diameter of the bars. The nominal diameter of a deformed bar is equivalent to the diameter of a plain bar having the same weight per foot as the deformed bar. Bar No. 2 in plain rounds only. All others in deformed rounds.

† Approximate to the nearest  $\frac{1}{8}$  in.

Table A4.2: Areas of Groups of Standard Bars, Square Inches

| Bar designation | Number of bars |      |      |      |      |       |       |       |       |       |       |       |       |  |
|-----------------|----------------|------|------|------|------|-------|-------|-------|-------|-------|-------|-------|-------|--|
|                 | 2              | 3    | 4    | 5    | 6    | 7     | 8     | 9     | 10    | 11    | 12    | 13    | 14    |  |
| No. 4           | 0.39           | 0.58 | 0.78 | 0.98 | 1.18 | 1.37  | 1.57  | 1.77  | 1.96  | 2.16  | 2.36  | 2.55  | 2.75  |  |
| No. 5           | 0.61           | 0.91 | 1.23 | 1.53 | 1.84 | 2.15  | 2.45  | 2.76  | 3.07  | 3.37  | 3.68  | 3.99  | 4.30  |  |
| No. 6           | 0.88           | 1.32 | 1.77 | 2.21 | 2.65 | 3.09  | 3.53  | 3.98  | 4.42  | 4.86  | 5.30  | 5.74  | 6.19  |  |
| No. 7           | 1.20           | 1.80 | 2.41 | 3.01 | 3.61 | 4.21  | 4.81  | 5.41  | 6.01  | 6.61  | 7.22  | 7.82  | 8.42  |  |
| No. 8           | 1.57           | 2.35 | 3.14 | 3.93 | 4.71 | 5.50  | 6.28  | 7.07  | 7.85  | 8.64  | 9.43  | 10.21 | 11.00 |  |
| No. 9           | 2.00           | 3.00 | 4.00 | 5.00 | 6.00 | 7.00  | 8.00  | 9.00  | 10.00 | 11.00 | 12.00 | 13.00 | 14.00 |  |
| No. 10          | 2.53           | 3.79 | 5.06 | 6.33 | 7.59 | 8.86  | 10.12 | 11.39 | 12.66 | 13.92 | 15.19 | 16.45 | 17.72 |  |
| No. 11          | 3.12           | 4.68 | 6.25 | 7.81 | 9.37 | 10.94 | 12.50 | 14.06 | 15.62 | 17.19 | 18.75 | 20.31 | 21.87 |  |

\* From "Design of Concrete Structures" by L. D. Urquhart, C.E. O'Rourke and G. Winter (Reference 5).

## APPENDIX V: DESIGN PROPERTIES OF STRESSTEEL BARS\*

TABLE A5.1: Design Properties of Stressteel Bars

| Nominal<br>Bar<br>Size<br>Ø"         | Nominal<br>Weight<br>Pounds<br>Lin/Ft. | Nominal<br>Area<br>Sq.<br>Inches | Ultimate<br>Strength<br>Guaranteed<br>Minimum |                    | Recommended<br>Initial Tensioning<br>Load—0.7 f's† |                    | Maximum<br>Recommended<br>Final Design<br>Load—0.6 f's† |                   |
|--------------------------------------|--|----------------------------------|---|--------------------|--|--------------------|---|-------------------|
|                                      |  |                                  | REGULAR<br>145 ksi                            | SPECIAL<br>160 ksi | REGULAR<br>101.5 ksi                               | SPECIAL<br>112 ksi | REGULAR<br>87 ksi                                       | SPECIAL<br>96 ksi |
| (All units in values of 1000 pounds) |  |                                  |   |                    |  |                    |   |                   |
| ½                                    | .67                                    | .196                             | 28  | 31                 | 20   | 22                 | 17  | 19                |
| ⅝                                    | 1.04                                   | .307                             | 45  | 49                 | 31   | 34                 | 27  | 30                |
| ¾                                    | 1.50                                   | .442                             | 64  | 71                 | 45   | 50                 | 39  | 42                |
| 7/8                                  | 2.04                                   | .601                             | 87  | 96                 | 61   | 67                 | 52  | 58                |
| 1                                    | 2.67                                   | .785                             | 114   | 126                | 80   | 88                 | 68  | 75                |
| 1 ⅛                                  | 3.38                                   | .994                             | 144   | 159                | 101  | 111                | 87  | 95                |
| 1 ¼                                  | 4.17                                   | 1.227                            | 178   | 196                | 125  | 137                | 107   | 118               |
| 1 ⅜                                  | 5.05                                   | 1.485                            | 215   | 238                | 151  | 166                | 129   | 143               |

† Design properties indicated are in accordance with ACI Building Code 318-63, Sections 2606 and 2607. Temporary jacking stresses up to 0.8f's are permitted to overcome losses due to tendon friction, anchorage seating and elastic shortening. Losses due to creep, shrinkage and steel relaxation should be deducted from the recommended initial

tensioning load to obtain actual final design load. Actual final design load, after losses are accounted for, may be less than 0.6f's.

See Specifications page 27 for a full description of physical properties.

\* From "Stressteel post tensioning", Catalog No. 55-6 (Reference 8).

APPENDIX VI: THE LOAD CELLS

The required specifications for the load cells were a maximum capacity of 500,000 lbs (250 tons), to monitor the tension on the cables over a long period of time, with a sensitivity of approximately 1000 lbs. High tensile steel (Atlas SPS 245) which has a yield strength of 140,000 psi was chosen for the load-bearing member. The load cell dimensions were designed to give a factor of safety of 6 at maximum load.

Figure A6.1 shows a section through the load cell. The load cell is basically a hollow steel cylinder with the top and bottom taking the form of the letter "I" for better stress distribution in the steel. The cable passes through the centre of the cell and the dimensions of the central hole were chosen so that the standard Freysinnet cone, which anchors the cable, would fit on top of the cell and by bearing directly on the cell transmit the cable load to it.

Two load-measuring systems were used in the cell, providing a cross check and to give a safeguard against any possible breakdown. The measuring systems are vibrating-wire strain gauges and resistance strain gauges. Since eccentric loading on the cell was a distinct possibility, four vibrating wires and four sets of strain gauges were placed at  $90^{\circ}$  intervals around the central circumference of the load cell.

The accuracy and range of the vibrating wires depend on the wire length; this length was pre-calculated from the elastic properties and dimensions of the steel cylinder. Temperature change should not affect the

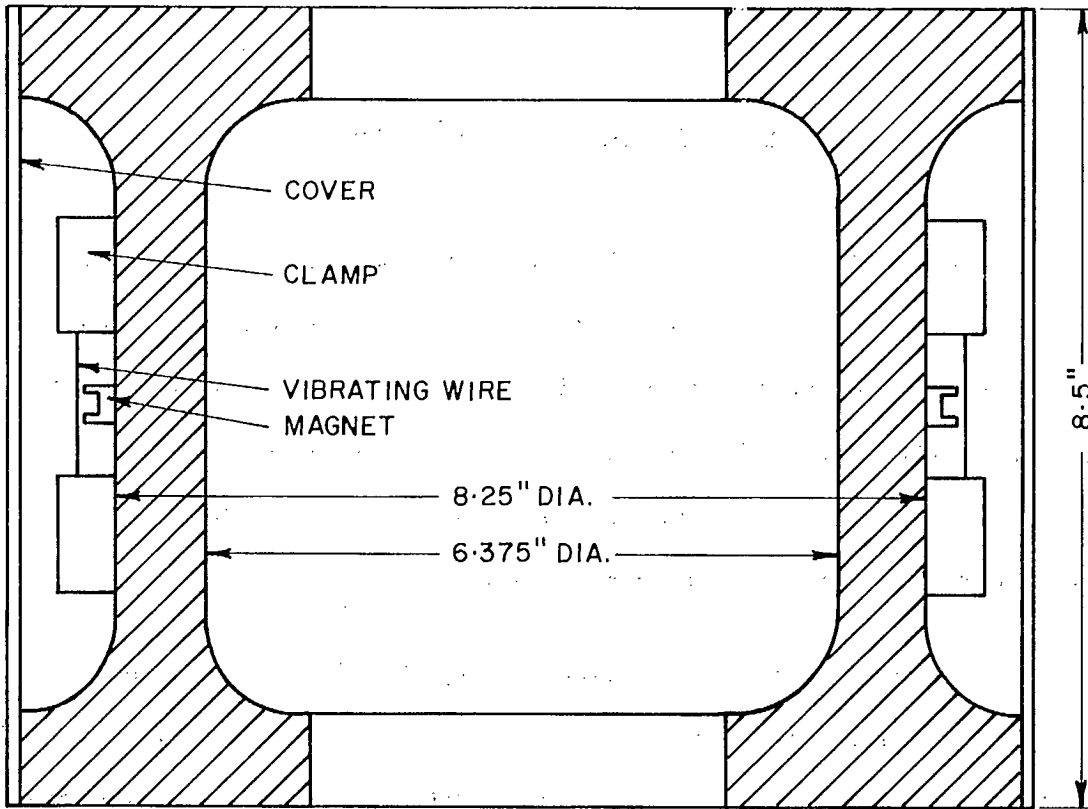

Figure A6.1. Schematic of the load cell.

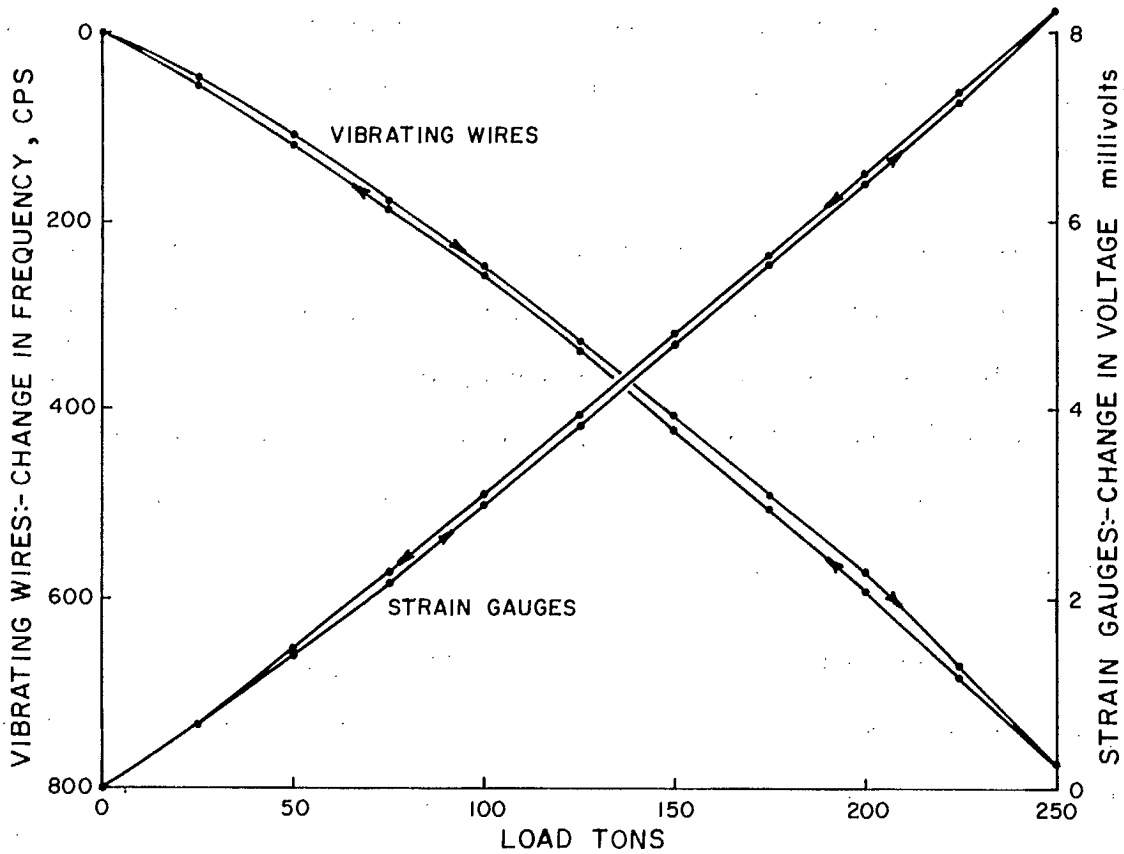

Figure A6.2. Load cell calibration.

vibrating-wire readings since the vibrating wire and the steel cylinder have nearly identical coefficients of thermal expansion. Readings were taken with a vibrating-wire comparator unit; each wire was read separately.

The accuracy and range of the resistance gauges were also estimated for design from the properties of the cylinder. Two 120-ohm gauges were bonded in the vertical position and two similar gauges were bonded in the horizontal position at each  $90^{\circ}$  interval. The horizontal gauges were used as temperature compensation gauges. All the resistance strain gauges were wired in a simple Wheatstone bridge network, so that the strains from each of the  $90^{\circ}$  interval positions were averaged. The strain gauge output was read with a potentiometer rather than the more usually used strain indicator. This enabled a constant current supply to be used rather than the normal constant voltage supply. The use of a constant current supply assists in minimizing errors due to small resistance changes in read-out cables, junction boxes, etc.

All the load cells were calibrated in the laboratory up to their maximum design capacity. Both uniform and eccentric loads were applied to the cell during these tests, the load being applied through the Freysinnet cone arrangement used with the cables. In addition, three load cells were subjected to a constant load of 250 tons for a period of 4 days to determine the stability of the gauges.

Figure A6.2 shows a typical load cell calibration. There is a small amount of hysteresis recorded by both the resistance and vibrating wire gauges; this may be a feature of the steel used in the cell. The strain gauge calibration curve is slightly non-linear at loads below 75 tons and linear between this value and 250 tons. Since the in-situ cable load was about 200 tons,



the strain gauges were operated over the linear portion of the curve. The vibrating-wire calibration curves are non-linear over the loading range. Consequently, individual calibration curves are required to determine the load in the cells. The calibration curves for uniform and eccentric loads were almost identical for all the load cells.

During the long-term, 4-day, stability tests at the maximum load of 250 tons, the maximum variation of the strain gauge read-out was 0.09 millivolt, equivalent to a load change of 2700 lbs. The vibrating-wire read-out had a maximum variation of 10 divisions, equivalent to a load change of 2900 lbs.

In conclusion, the discrimination of load change for both the vibrating wire and the strain gauges was found to be better than  $\pm 300$  lbs for all cells, and their overall accuracy was better than  $\pm 3000$  lbs.

APPENDIX VII: SENSITIVITIES OF VIBRATING-WIRE EXTENSOMETERSExtensometer No. 1 - Lower bench - Horizontal borehole (unit 6)

| Wire Number | Cantilever Number | Anchor Depth | Sensitivity when used with PC 101 Comparator |
|-------------|-------------------|--------------|--|
| 1.1         | 2                 | 248 ft       | 1.99 thou/div.                               |
| 1.2         | 3                 | 200 ft       | 1.91 thou/div.                               |
| 1.3         | 4                 | 115 ft       | 1.43 thou/div.                               |
| 1.4         | 1                 | 59 ft        | 1.41 thou/div.                               |

Extensometer No. 2 - lower bench - 40° down hole (unit 5)

| Wire number | Cantilever Number | Anchor Depth | Sensitivity used with PC 101 Comparator |
|-------------|-------------------|--------------|---|
| 2.1         | 1                 | 200 ft       | 2.10 thou/div.                          |
| 2.2         | 4                 | 135 ft       | 2.56 thou/div.                          |
| 2.3         | 3                 | 79 ft        | 1.53 thou/div.                          |
| 2.4         | 2                 | 43 ft        | 1.61 thou/div.                          |

Extensometer No. 3 - upper bench - 40° down hole (unit 4)

| Wire number | Cantilever Number | Anchor Depth | Sensitivity used with PC 101 Comparator |
|-------------|-------------------|--------------|---|
| 3.1         | 1                 | 140 ft       | 1.84 thou/div.                          |
| 3.2         | 2                 | 87 ft        | 1.34 thou/div.                          |
| 3.3         | 3                 | 50 ft        | 1.45 thou/div.                          |
| 3.4         | 4                 | 25 ft        | 1.22 thou/div.                          |

Extensometer No. 4 - Upper Bench - Vertical down hole (unit 3)

| Wire Number | Cantilever Number | Anchor Depth | Sensitivity used with PC 101 Comparator |
|-------------|-------------------|--------------|---|
| 4.1         | 1                 | 200 ft       | 2.31 thou/div.                          |
| 4.2         | 2                 | 150 ft       | 2.11 thou/div.                          |
| 4.3         | 3                 | 120 ft       | 1.77 thou/div.                          |
| 4.4         | 4                 | 66 ft        | 1.93 thou/div.                          |



1. The Test Site.



2. Upper Bench After Clean Up.



3. Lower Bench After Clean Up.

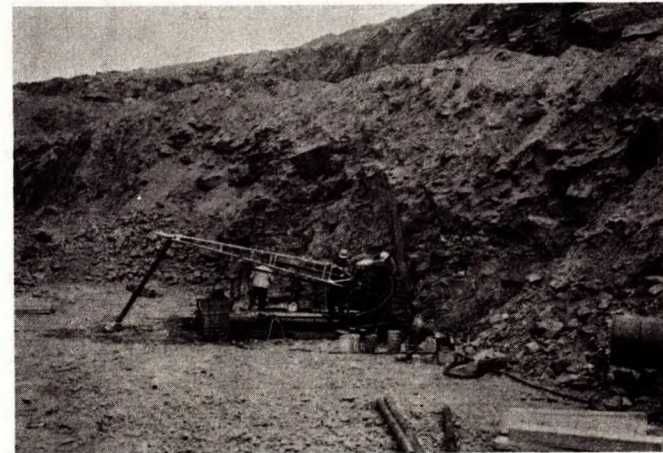

4. Drilling the Anchor Holes.





5. Borehole Television Camera.

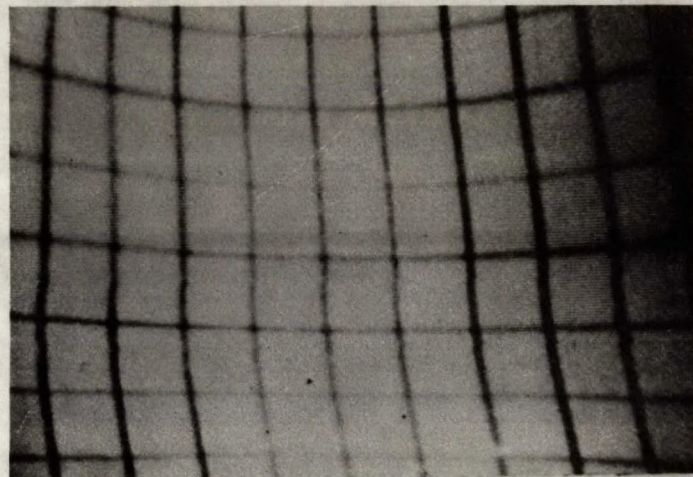

6. Television Photo of 1/4" x 1/4" Reference Grid.

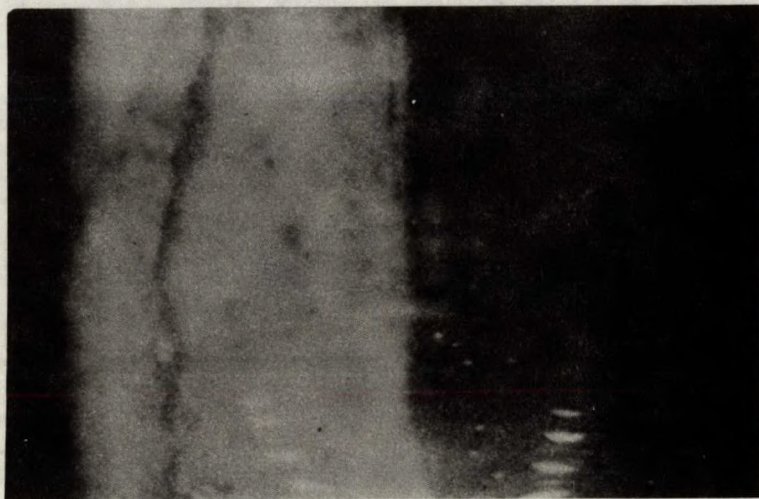

7. Television Photo of a Joint Parallel to the Hole Axis.



8. Core from the Same Position as Photo 7, Showing Longitudinal Joint.



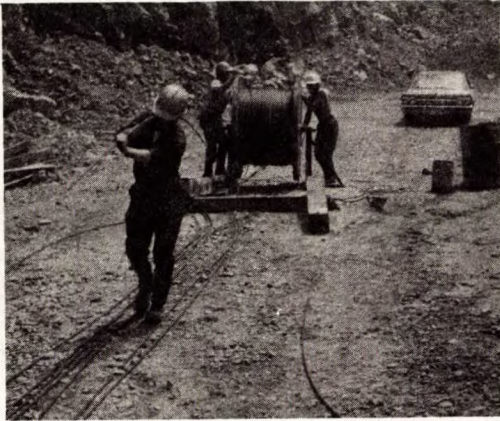

9. Cable Anchor Assembly - 12 Strand Cable  
Assembled on Site from Individual Strands.

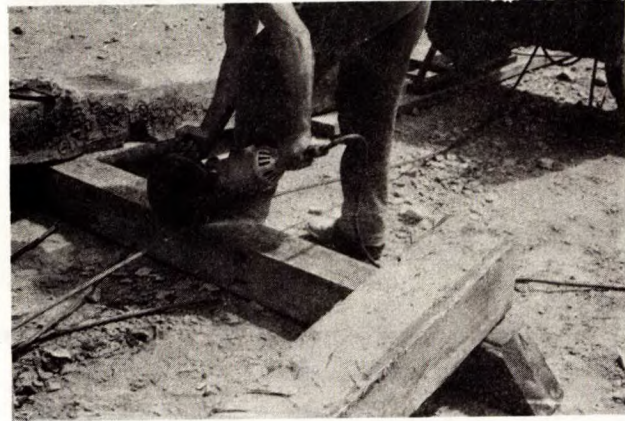

10. Cable Anchor Assembly - Cutting Strands  
to Length.

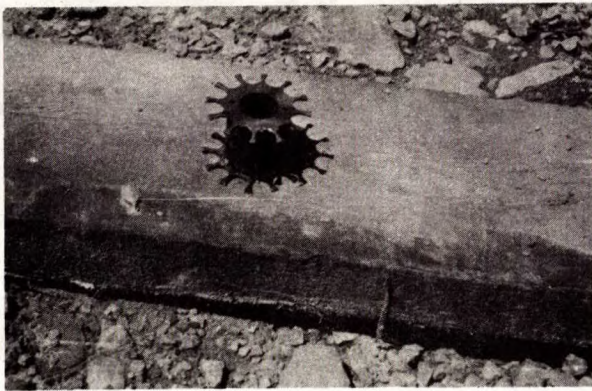

11. Cable Anchor Assembly- Strand Spacer.



12. Cable Anchor Assembly- Positioning the  
Strands on the Spacer.





13. Assembled Cable Showing Spacer in Position and Nose Cone.



14. Installing the Cable.

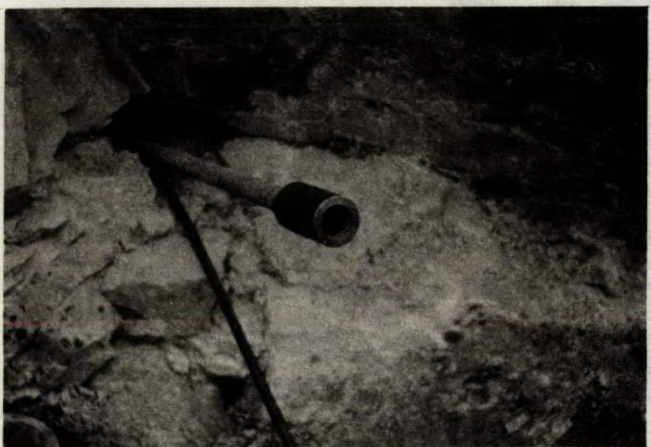

15. Stressteel Rod - Female Coupling.



16. Stressteel Rod - Male Coupling.





17. Installing the Stressteel Rod.



18. Mesh Lengths Laid Out and Wired Together on the Surface.



19. Wiring Mesh Sections Together (Showing Wire-Twisting Device).



20. Wire-Twisting Device in Use.





21. Wire-Twisting Device in Use.

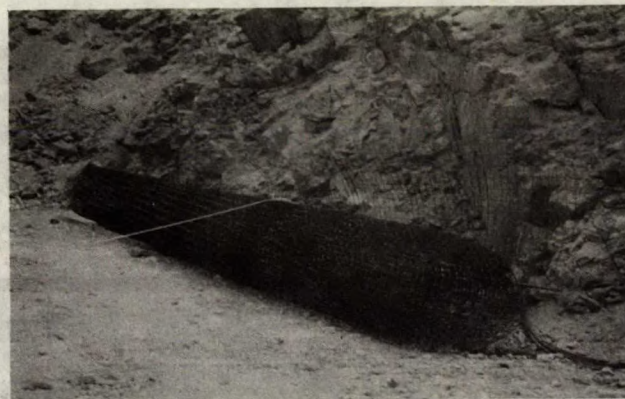

22. Wire Roll in Position on Top Bench.



23. Wire Roll Anchored Temporarily  
by Short Bolts.



24. Wire Mesh Rolled Over Bench Edge.





25. Wire Mesh in Position.



26. Wire Mesh in Position.



27. Form Work for Horizontal Concrete Stringer - Lower Bench.

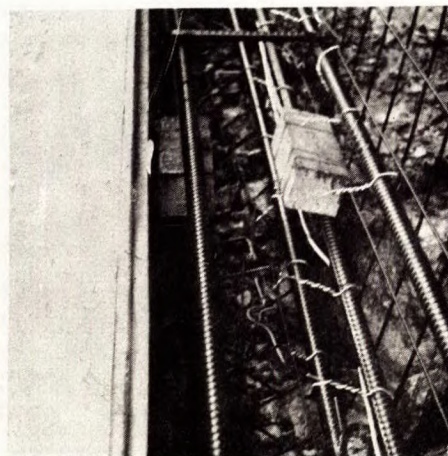

28. Concrete Strain Gauges in Bricks to be Cast into the Stringer.





29. Concrete Stringer Poured.



30. Form Work for Anchor Pads on Top Bench and Steel Bar Horizontal Stringer,



31. Extensometer Installations (Top Bench).

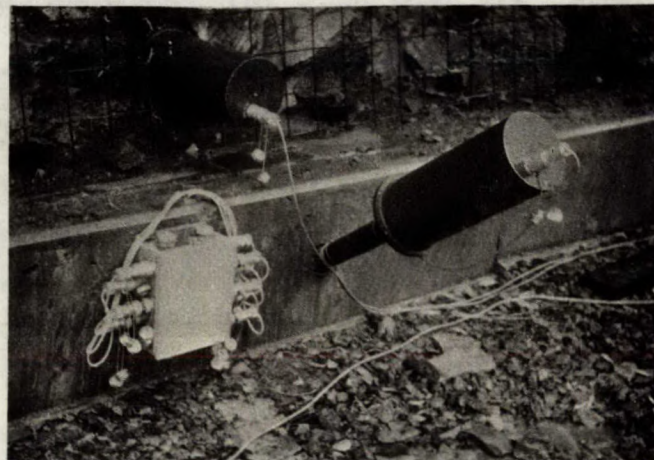

32. Extensometer Installations (Lower Bench).



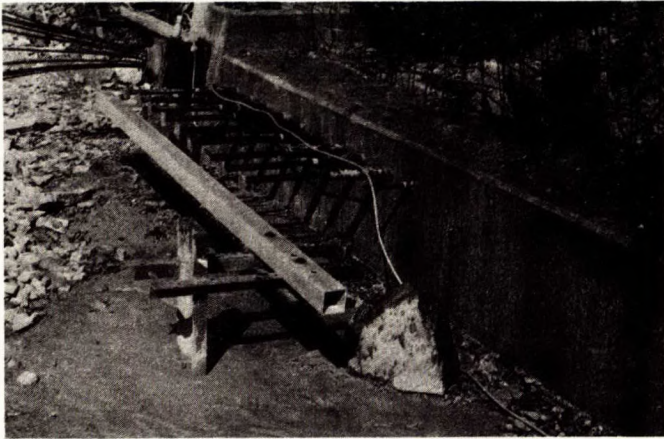

33. Beam and Studs for Surface Displacement Measurements - Lower Bench.



34. Beams and Studs for Surface Displacement Measurements - Upper Bench.

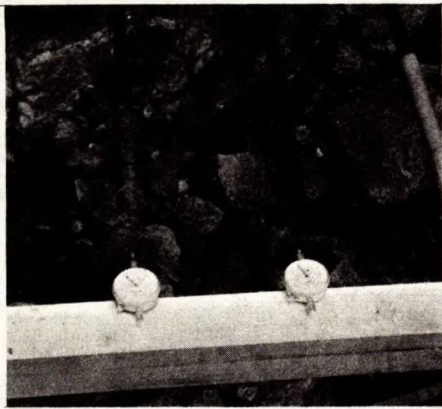

35. Dial Gauges Probing Surface Studs.



36. Cable Anchor Tensioning Jack.



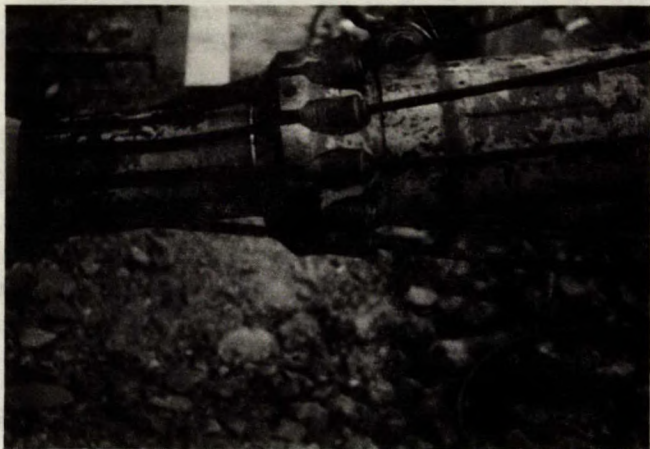

37. Strand Attachment to Jack.



38. Load Cell Between Concrete Pad and Tensioning Jack,



39. Cone and Wedge to Lock Cable.

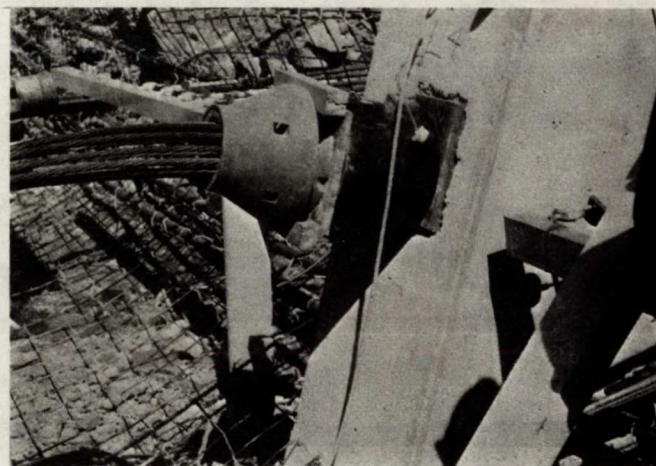

40. Use of a Chair to Release Cone and Wedge Lock.



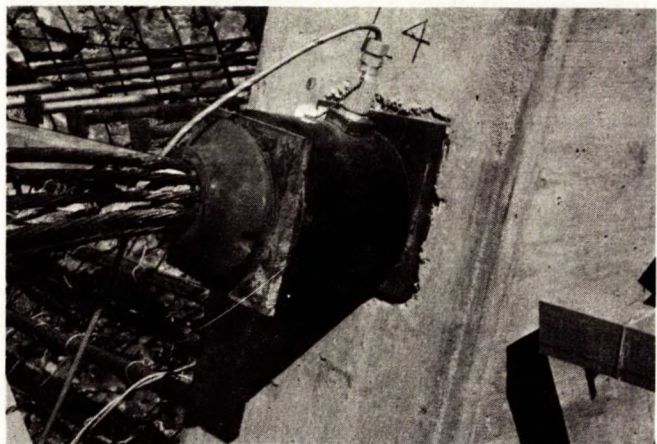

41. Cable Tensioned and Locked.

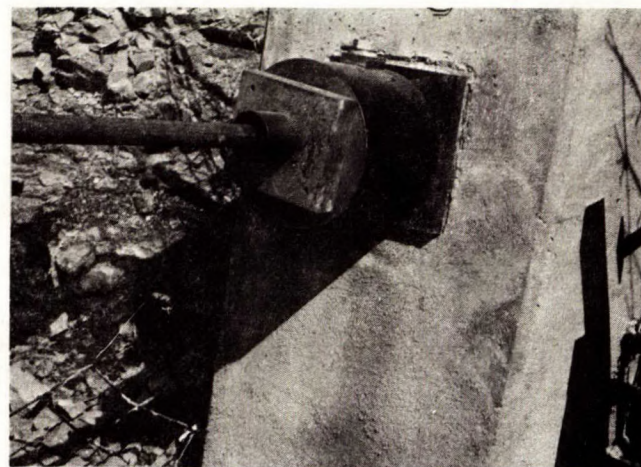

42. Stressteel Anchor and Load Cell.

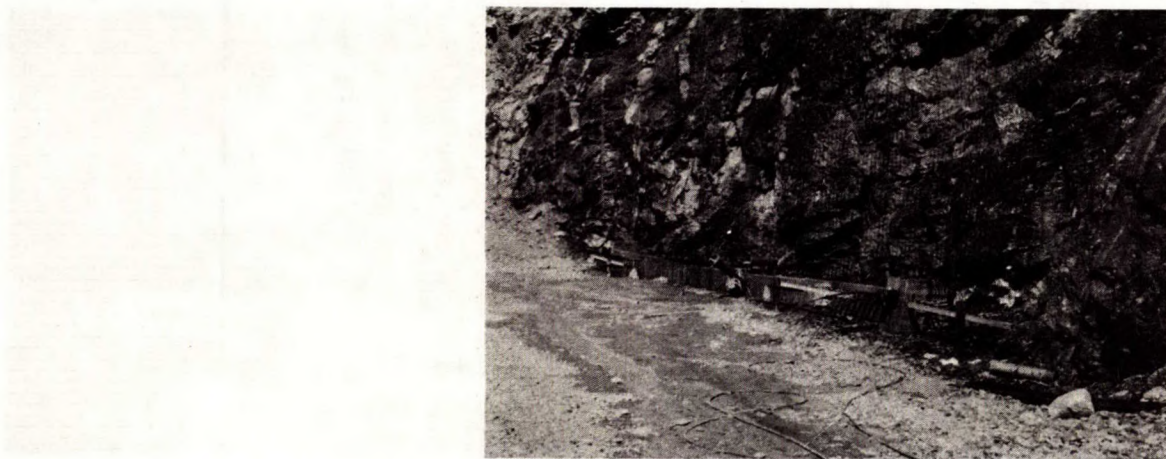

43. Completed Installation - Lower Bench.

APPENDIX IX: CONSTRUCTION COSTS OF TRIAL INSTALLATION

| Job and Itemization   | Total     |           |
|---|-----------|-----------|
| 1. Site preparation   |           |           |
| 2. <u>Anchor hole drilling</u>  |           |           |
| H size 229 ft at \$10.97/ft   | \$2510.00 |           |
| NX casing 167 ft at \$11.20/ft  | \$1870.00 |           |
| Sub total   | \$4380.00 | \$4380.00 |
| 3. <u>Wire Mesh</u>   |           |           |
| <u>Materials</u> 8400 sq ft of 66-44 mesh<br>at \$6.35/100 sq ft                | \$533.00  |           |
| 200 lbs No. 9 annealed galvanized<br>wire at \$15.32/100 lbs.                   | \$ 31.00  |           |
| <u>Labour</u> Total labour 237 man-hours<br>approximately split into:           |           |           |
| 137 man hours at helper's rate,<br>assumed \$2.50/hour                          | \$343.00  |           |
| 100 man hours at tradesman's<br>rate, assumed \$3.10/hour                       | \$310.00  |           |
| To cover fringe benefits, overheads,<br>add 15% to labour costs                 | \$ 98.00  |           |
| <u>Equipment</u> Front end loader 7½ hours<br>(at \$10/hour including operator) | \$ 75.00  |           |
| Mobile crane 1 hour<br>(at \$10/hour including operator)                        | \$ 10.00  |           |
| Sub total   | \$1400.00 | \$1400.00 |

|   |          | Total    |
|---|----------|----------|
| 4. <u>Steel Rod Stringer Beam and Abutments</u>   |          |          |
| <u>Forming and steel work</u>   |          |          |
| Labour, 50 man-hours (25 hrs at 2.50 +<br>25 hours at 3.10 + 15% overhead, fringe<br>benefits, etc).  | \$161.00 |          |
| Reinforcing for steel abutments   | \$ 16.00 |          |
| 5 No. 11 A432 steel bars 56 ft long<br>(5.313 lbs/ft) at \$142.00/ton +<br>tax + freight<br>[5 x 56 x 5.313 = 1490 lbs = 0.67 tons =<br>\$95 not including tax and freight] | \$ 95.00 |          |
| Forming materials   | \$ 30.00 |          |
| <u>Concrete work</u>  |          |          |
| Labour, 10 man-hours [5 hrs at \$2.50/hr,<br>5 at 3.10/hr + 15%]  | \$ 32.00 |          |
| Class 4000 concrete, 3½ cu yds at \$22.30<br>cu yd  | \$ 78.00 |          |
| <u>Positioning of rods and fastening rods to<br/>Wire mesh</u>  |          |          |
| Labour, 32 man-hours [16 at 2.50/hr,<br>16 at 3.10/hr + 15%]  | \$103.00 |          |
| Sub total   | \$515.00 | \$515.00 |
| 5. <u>Concrete Stringer Beam and Abutments</u>  |          |          |
| <u>Forming and steel work</u>   |          |          |
| Labour, 61 man-hours (31 at 2.50,<br>30 at 3.10 + 15%)  | \$196.00 |          |
| 6 No. 10 A432 bars (56 ft long at 4.303 lbs/<br>ft; \$140/ton)<br>6 x 56 x 4.303 = 1445 lbs = 0.65 tons at<br>\$140/ton   | \$ 91.00 |          |
| Reinforcing steel   | \$ 20.00 |          |
| Forming materials   | \$ 50.00 |          |



| <u>Concrete Work</u>  |          | Total    |
|---|----------|----------|
| Labour, 15 man-hours (7 at 2.50 + 7 at 3.10 + 15%)                    | \$ 48.00 |          |
| Class 4000 concrete, 12 cu yds at 22.30/cu yd                         | \$268.00 |          |
| Sub total   | \$673.00 | \$673.00 |
| <hr/>   |          |          |
| 6. <u>Anchors</u>   |          |          |
| <u>Type 1. 12/0.5 tendons</u>   |          |          |
| Total labour 3 anchors, 31½ hours<br>(at 3.10/hour + 15%)             | \$113.00 |          |
| Fixed cost for 3 anchors<br>(at \$40.37 per anchor)                   | \$122.00 |          |
| Total footage = 40 + 120 + 205 =<br>365 ft at 1.20/ft                 | \$438.00 |          |
| <u>Type 2. 1 3/4 stressteel bars</u>                                  |          |          |
| Total labour 1 hour (at 3.10 + 15%)                                   | \$ 3.60  |          |
| Fixed cost per anchor, 1 anchor at 19.04                              | \$ 19.04 |          |
| Total footage, 62 ft at 1.82/ft                                       | \$113.00 |          |
| 2 couplings (at 20-ft intervals) at<br>7.80/coupling                  | \$ 15.60 |          |
| Sub total   | \$824.24 | \$824.00 |
| <hr/>   |          |          |
| 7. <u>Grouting of Anchors</u>   |          |          |
| Labour 4 holes at 6 man hours/hole = 24 man-<br>hours (at 3.10 + 15%) | \$ 86.00 |          |
| Grouting mixture at \$5.00 per hole, 4 holes                          | \$ 20.00 |          |
| Equipment rental 1 week, \$60 month                                   | \$ 15.00 |          |
| Sub total   | \$121.00 | \$121.00 |

| 8. <u>Tensioning Anchors</u>   | Total    |           |
|--|----------|-----------|
| <u>Type 1. 12/0.5 tendon</u>   |          |           |
| Labour, 3 man-hours/cable x 3 cables =<br>9 man-hours at 3.10 hr + 15% | \$ 32.00 |           |
| Jack and pump rental (assume 1 week<br>minimum charge) at \$75/week    | \$ 75.00 |           |
| <u>Type 2. 1 3/8 stressteel rod</u>                                    |          |           |
| Labour, 1½ man-hours/rod = 1½ hours<br>at 3.10 + 15%                   | \$ 5.35  |           |
| Jack and pump rental (assume 1 week<br>minimum charge) at \$50/week    | \$ 50.00 |           |
| Sub total  | \$162.35 | \$162.00  |
| 9. <u>Final grouting of the Cables</u>                                 |          |           |
| Labour, 12 man-hours at 3.10 + 15%                                     | \$ 41.50 |           |
| Grouting cement, 16½ bags at 2.50                                      | \$ 41.25 |           |
| Mixer and pump rental (assume 1 week<br>minimum, \$60/month)           | \$ 15.00 |           |
| Sub total  | \$ 97.75 | \$ 98.00  |
| TOTAL  |          | \$8173.00 |

APPENDIX X: PLATE LOAD TESTS

As mentioned in the text, the operation of tensioning the cable anchors against the concrete anchor pads is, in effect, a plate load test. It was therefore decided to measure the surface displacement of the ground around the pads during several cycles of loading on each pad prior to final tensioning of the anchor. In this manner a measure of the modulus of the surface rock could be obtained.

The displacements of the surface rock were measured at various distances from the anchor pads by probing steel studs set 6 inches into the surface rock at various distances from the anchor pads. These studs were probed by means of dial gauges attached to a rectangular aluminum beam which in turn was supported by a rigid foundation comprising a steel beam cast in concrete at approximately 8 ft from the anchor pads. It was assumed that the support 8 ft away was outside the influence of the load on the rock. Figure A.10.1 illustrates this arrangement and Photographs 33, 34 and 35 in Appendix VIII show the arrangement in the field.

Whilst it was planned to carry out these tests on all four anchor pads, in fact only two were successfully completed. It was found that the displacement base set up around the 55-ft hole was not stable and in consequence erratic dial gauges readings were obtained. Tests at this site were therefore discontinued. The 195-ft cable produced problems in load cycling. Whilst it was possible to load the cable during the up cycle satisfactorily, the stretch of this long cable was such that the ram extension was fully used up and the cable had to be locked, the ram retracted and then loading recommenced half-way up the loading cycle. This readjustment of the ram during the cycle

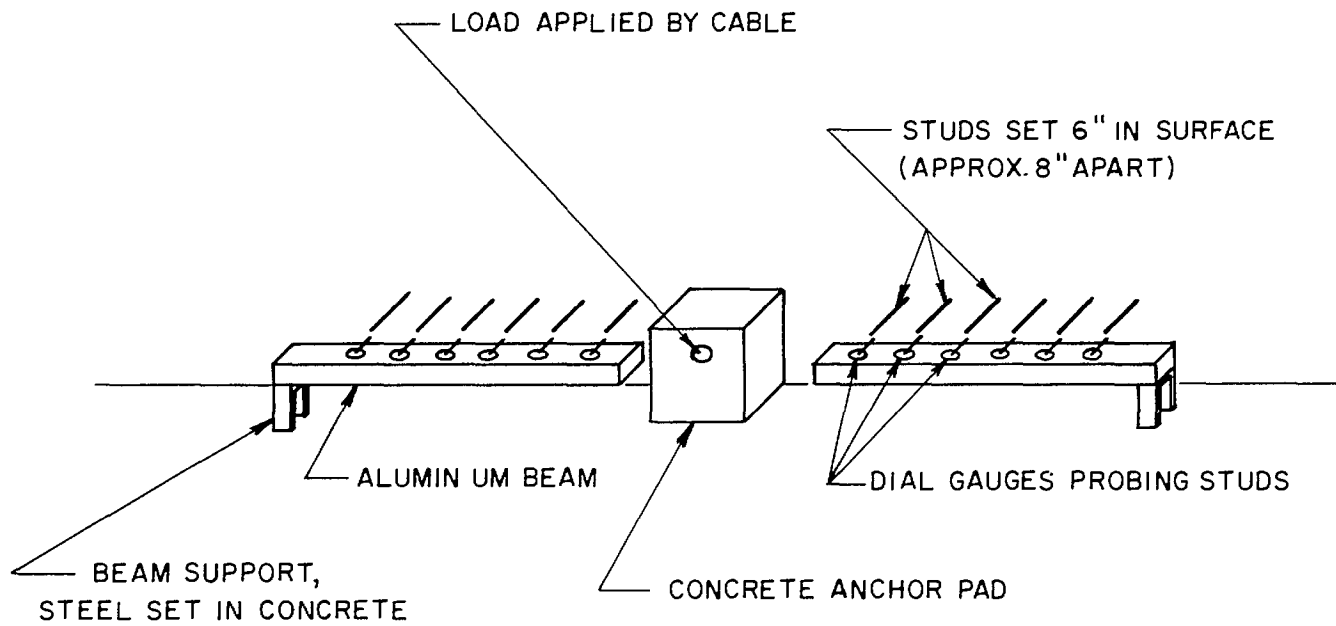

Figure A10.1. Plate load test arrangement.

produced problems during the down cycle, as it was found to be very difficult to unlock the cable for relaxation in the middle of the down cycle. A ram with a longer extension was not available; thus, this test was discontinued after one complete load application and a reduction to half level. The cable was then loaded to its final tension. This completion of only 3/4 of a load cycle was insufficient to make it worthwhile interpreting the results.

However, three load cycles were successfully completed on the 33-ft cable and on the 110 ft cable. These results are now presented and interpreted. Figure A 10.2 shows typical load-deformation plots for the first pins on either side of the concrete "plate", for each of the three load cycles. It is seen that there is a considerable irrecoverable displacement during the first cycle, due to closing of joint and fissures, etc. Thereafter the second and third cycles are fairly repeatable. From these graphs for all the measuring studs, the displacements were plotted against their distance from the loading point for three load levels at 100,000 lbs, 200,000 lbs, and 300,000 lbs. Figure A10.3 shows these displacements for the first cycle, and for the mean values of the second and third cycles, for the tests at the 33-ft cable site. The rock modulus was estimated in the following manner.

If it is assumed that the concrete bearing pad is circular, with radius R (actually it was rectangular so that a circle of equivalent area was assumed), that this footing is rigid, and that  $\nu$  is the Poisson's ratio, then it has been shown (9) that the displacement of the surface at any point at radius r ( $r > R$ ) is given by:

$$d = \frac{Q(1-\nu^2)}{\pi RE} \sin^{-1} (R/r)$$

where E is the Young's modulus and Q is the applied load.

LEGEND

- x— 1st cycle
- -o- - 2nd cycle
- ...Δ... 3rd cycle

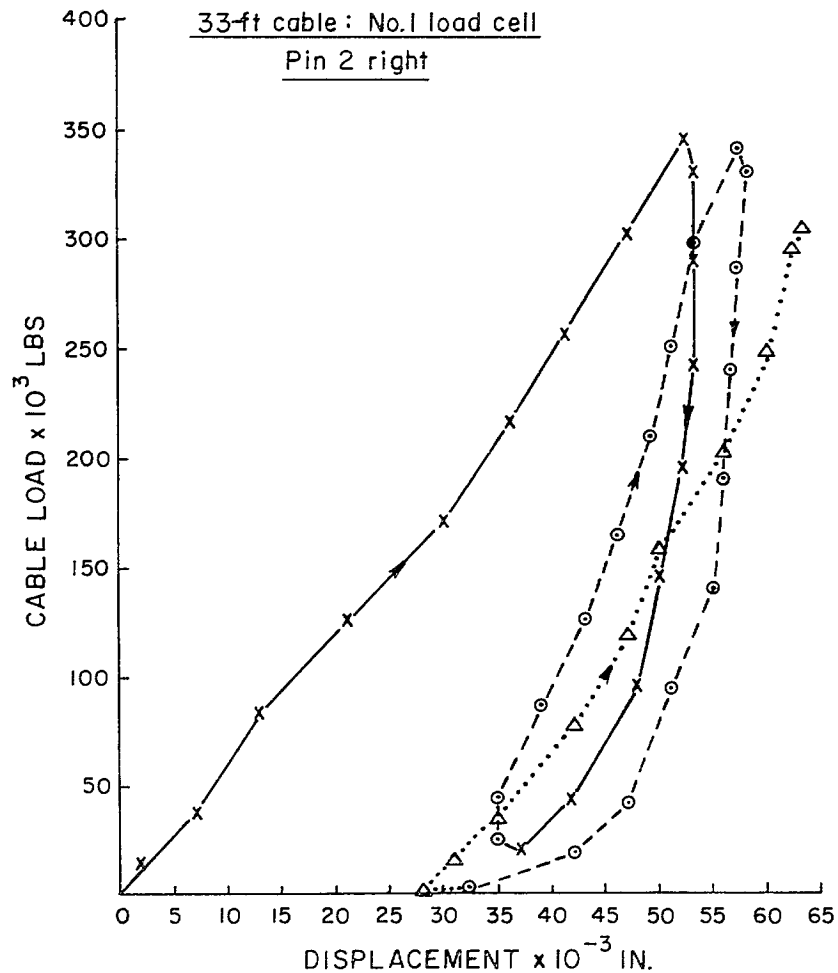
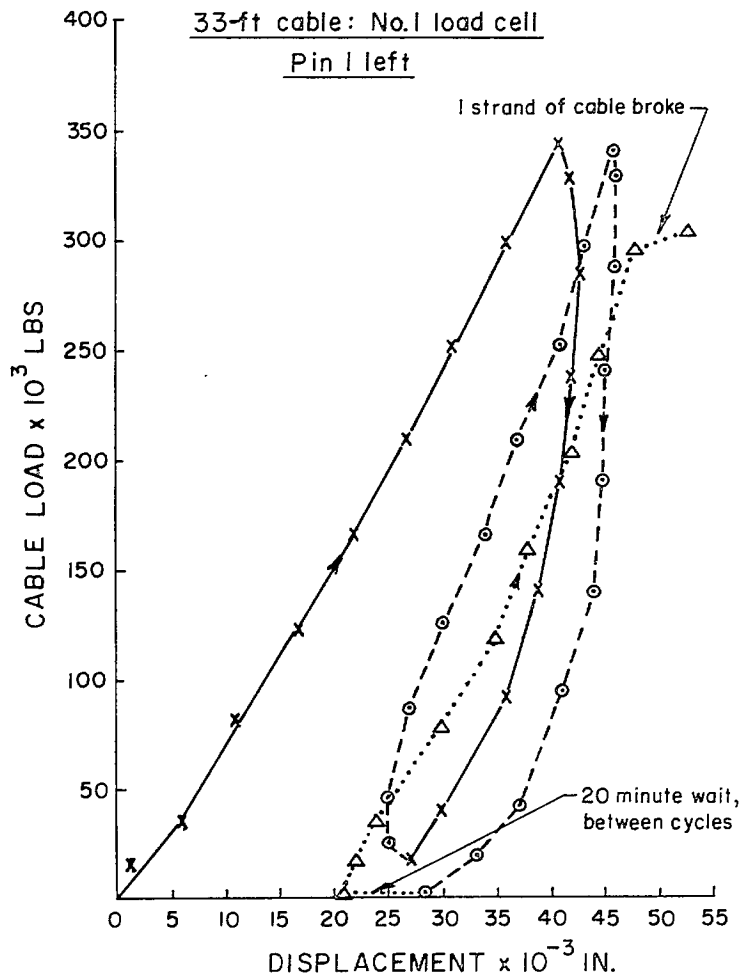

Figure A10.2. Displacements during plate load test cycles.

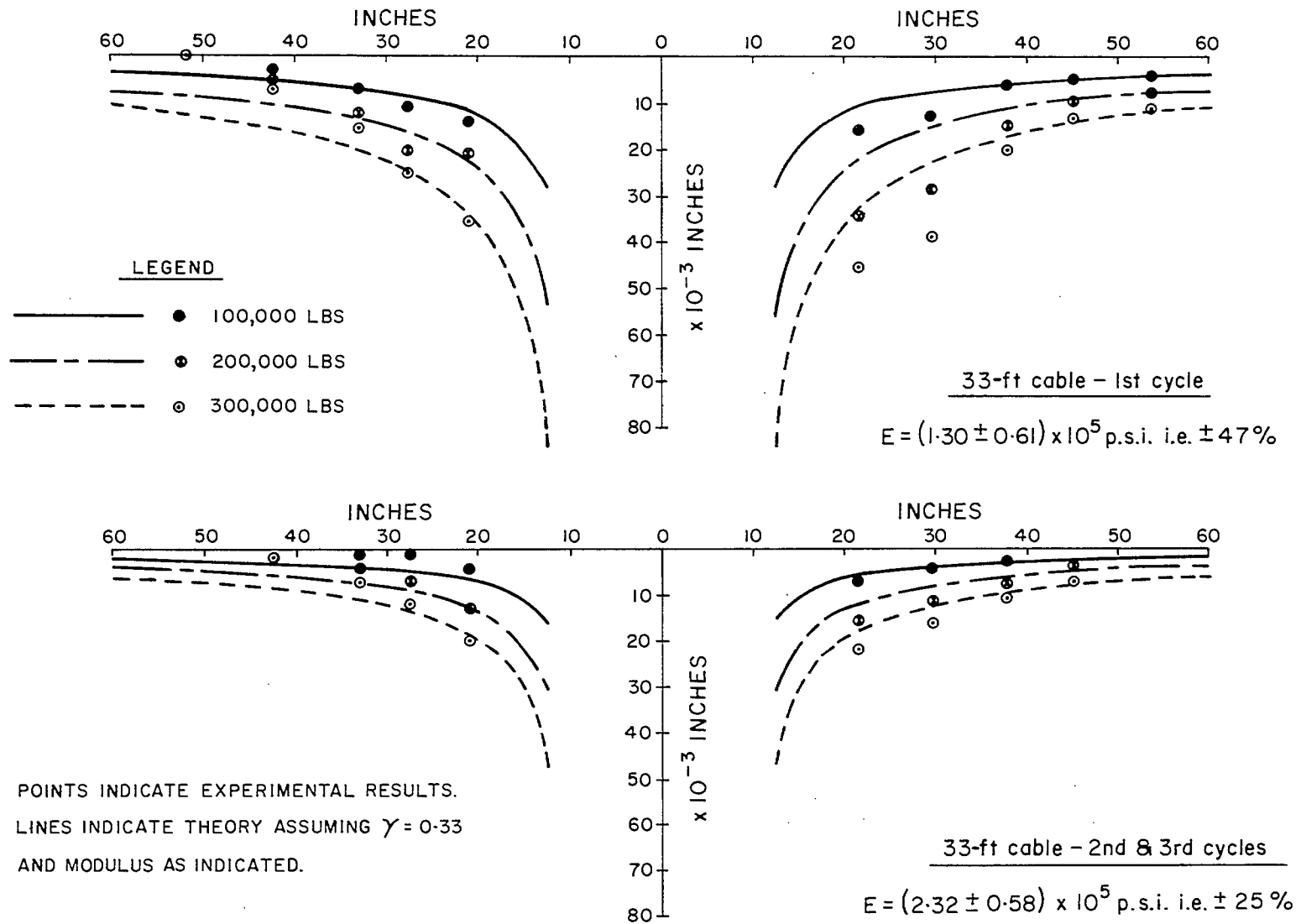

Figure A10.3. Surface displacements during plate load testing, 33-ft cable site.

Hence from this equation, assuming  $\nu = 0.33$ , the Young's modulus  $E$  was calculated for each point at radius  $r$  for each of the three applied loads, using the measured deflection  $d$  at that point. Table A10.1 gives the results of these calculations for the first load cycle and for the mean displacements from the second and third load cycles. It is seen from this table that a relatively wide range of moduli are derived from these calculations. There is a tendency for the high value of modulus to be derived from the low values of measured displacement. Since these displacements would be the most in error, all moduli calculated from displacements of less than  $5 \times 10^{-3}$  inches were ignored and the remainder were averaged. These average values so obtained were:

$$\text{for the first cycle: } E = 1.30 \pm 0.61 \times 10^5 \text{ psi}$$

$$\text{for the second and third cycles: } E = 2.32 \pm 0.58 \times 10^5 \text{ psi}$$

Using these values of the modulus, the displacements for all points under each of the 3 loads were calculated and have been plotted as solid lines in Figure A10.3. It is seen that these values give reasonable overall agreement with the measured displacement.

Figure A10.4 gives the similar results for the 100-ft cable site. In this case no displacements were recorded on the right-hand side of the plate, due to a large joint intervening between the plate and the first stud. In this case the values of  $E$  determined were:

$$\text{1st cycle: } E = (1.27 \pm 0.45) \times 10^5 \text{ psi}$$

$$\text{2nd and 3rd cycles: } E = (1.92 \pm 0.35) \times 10^5 \text{ psi}$$



TABLE A10.1: CALCULATION OF MODULUS FROM PLATE LOAD DISPLACEMENTS

(a)

33 ft cable: Load cell No. 1. R = 12.25 inches  $\nu = 0.33$

| Pin No. | r inches | LOAD = 100,000 lbs.             |                                 | LOAD = 200,000 lbs.             |                                 | LOAD = 300,000 lbs.             |                                 |
|---------|----------|---------------------------------|---------------------------------|---------------------------------|---------------------------------|---------------------------------|---------------------------------|
|         |          | Measured $d \times 10^{-3}$ in. | Calculated $E \times 10^5$ psi* | Measured $d \times 10^{-3}$ in. | Calculated $E \times 10^5$ psi* | Measured $d \times 10^{-3}$ in. | Calculated $E \times 10^5$ psi* |
| 5L      | 51.75    | 0                               | -                               | 0                               | -                               | 0                               | -                               |
| 4L      | 42.5     | 2.5                             | 2.71                            | 5                               | 2.71                            | 6                               | 3.38                            |
| 3L      | 33.25    | 7                               | 1.25                            | 12                              | 1.47                            | 15                              | 1.74                            |
| 2L      | 27.75    | 10.5                            | 1.00                            | 20                              | 1.06                            | 25                              | 1.27                            |
| 1L      | 21.25    | 14                              | 1.04                            | 26                              | 1.13                            | 35.5                            | 1.24                            |
| 1R      | 21.50    | 16.5                            | 0.85                            | 34                              | 0.82                            | 46.5                            | 0.90                            |
| 2R      | 29.50    | 14                              | 0.71                            | 28.5                            | 0.70                            | 39                              | 0.87                            |
| 3R      | 37.75    | 6                               | 1.28                            | 15                              | 1.02                            | 20                              | 1.15                            |
| 4R      | 45.25    | 4.5                             | 1.41                            | 9.5                             | 1.33                            | 13                              | 1.45                            |
| 5R      | 53.50    | 4.0                             | 1.33                            | 7.5                             | 1.42                            | 11                              | 1.45                            |

1st cycle. Mean Modulus (when  $d > 5 \times 10^{-3}$  in.) =  $(1.30 \pm 0.61) \times 10^5$  psi; coefficient of variation =  $\pm 47\%$

(b)

33 ft cable: Load cell No. 1. R = 12.25 inches  $\nu = 0.33$

| Pin No. | r inches | LOAD = 100,000 lbs.             |                                 | LOAD = 200,000 lbs.             |                                 | LOAD = 300,000 lbs.             |                                 |
|---------|----------|---------------------------------|---------------------------------|---------------------------------|---------------------------------|---------------------------------|---------------------------------|
|         |          | Measured $d \times 10^{-3}$ in. | Calculated $E \times 10^5$ psi* | Measured $d \times 10^{-3}$ in. | Calculated $E \times 10^5$ psi* | Measured $d \times 10^{-3}$ in. | Calculated $E \times 10^5$ psi* |
| 4L      | 42.5     | -                               | -                               | -                               | -                               | 1.5                             | 13.6                            |
| 3L      | 33.25    | 0.5                             | 1.74                            | 3.5                             | 4.99                            | 7                               | 3.74                            |
| 2L      | 27.75    | 1                               | 1.06                            | 7                               | 3.01                            | 11.5                            | 2.76                            |
| 1L      | 21.25    | 4                               | 3.65                            | 13                              | 2.25                            | 20                              | 2.19                            |
| 1R      | 21.50    | 7                               | 2.00                            | 16                              | 1.75                            | 22                              | 1.91                            |
| 2R      | 29.50    | 4                               | 2.48                            | 11                              | 1.80                            | 16                              | 1.86                            |
| 3R      | 37.75    | 2.5                             | 3.07                            | 7.5                             | 2.04                            | 10.5                            | 2.19                            |
| 4R      | 45.25    | -                               | -                               | 3.5                             | 3.62                            | 7                               | 2.71                            |

2nd & 3rd cycles: Mean Modulus (when  $d > 5 \times 10^{-3}$  in.) =  $(2.32 \pm 0.58) \times 10^5$  psi; coefficient of variation =  $\pm 25\%$ .

\* Calculated from  $E = \frac{Q(1-\nu^2)}{\pi R d} \sin^{-1}(R, r)$ .

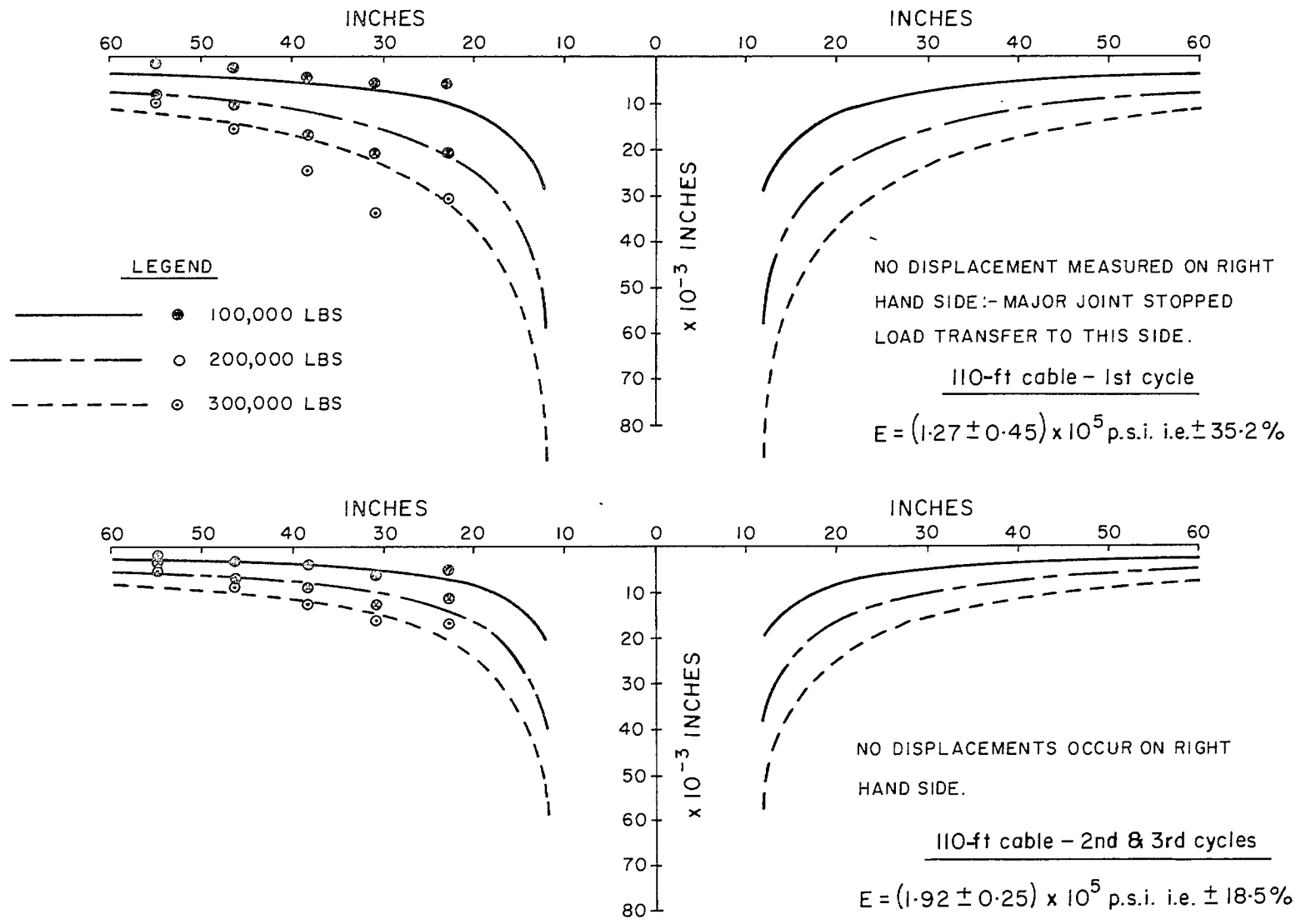

Figure A10.4. Surface displacements during plate load testing - 110-ft cable site.

Table A10.2 summarizes these results. Since the 1st cycle results include a considerable influence due to irrecoverable displacement, it is thought that the average of the 2nd and 3rd cycles from each set of results gives the best approximation to the in-situ rock modulus:

This value is  $(2.12 \pm 0.51) \times 10^5$  psi. Coefficient of variation = +24%.

The modulus of laboratory specimens of granite from this mine is approximately  $9 \times 10^6$  psi. Thus, it is seen that the modulus of the surface rock is very much less than would be determined from laboratory measurements.

TABLE A10.2: MODULI DETERMINED FOR SURFACE LOADING AND DISPLACEMENT MEASUREMENTS

| Test Cable | 1st Loading Cycle                     | Mean 2nd and 3rd Loading Cycles   |
|------------|---------------------------------------|---|
| 33 ft      | $E = (1.30 \pm 0.61) \times 10^5$ psi | $E = (2.32 \pm 0.58) \times 10^5$ psi                                     |
| 55 ft      | E not determined - displacement       | Base unstable - erratic readings  |
| 110 ft     | $E = (1.27 \pm 0.45) \times 10^5$ psi | $E = (1.92 \pm 0.35) \times 10^5$ psi                                     |
| 195 ft     |                                       | Only one cycle conducted due to inability to unlock cable for relaxation. |

MEAN

$$E = (2.12 \pm 0.51) \times 10^5 \text{ psi}$$

$$\text{In-Situ Rock Mass Modulus} = 2.12 \times 10^5 \text{ psi} \pm (0.51 \times 10^5) \text{ i.e. } \pm 24\%$$

APPENDIX XI: ONTARIO HYDRO DOWN-HOLE TELEVISION CAMERA: AN ASSESSMENT.

The slope stability project included logging of the anchor holes by down-hole viewing. Four holes were surveyed with the Ontario Hydro television camera. The purpose was to look at the rock mass that was to be anchored in situ and to assess the value of the camera as a tool to obtain information on discontinuities in the rock mass.

The television camera was designed to fit into NX (3-inch diameter) drill holes. Since the anchor holes were drilled with H casing (3½-inch diameter), eccentric spacer rings were required to locate the camera the proper distance from the wall of the hole. Through the use of a mirror and different light sources, the camera can be adjusted to view straight ahead (i.e. down the hole) or at right angle to the hole axis. Down-the-hole viewing was unsuccessful in this trial mainly because of the larger diameter of the holes. The field of view, perpendicular to the hole axis, covers about 1/3 of the circumference or an area 2 inches (axial) by 3.6 inches (radial). This area is seen at about 2X enlargement on the viewing screen.

Resolution of the image is affected by clarity of the water, colour contrast, and shape of the object viewed. Clear water is an absolute necessity. The anchor holes had not been washed sufficiently; motion of the camera caused a suspension of fine sediment to cloud the image. When clear water conditions prevail, linear features with high colour contrast can be observed to a minimum width of 1/100 inch. Surface relief (i.e. open fractures, loose grains, etc.) is visually enhanced by the oblique light source. Distortion of the image is illustrated in Figure A11.1 which shows the television image of a 1/4-inch grid.

Positioning of the camera in the hole is a very important factor in the application of this logging technique. Axial distance was measured by the number of rods in the hole; rotational position was taken as the midpoint between limits of slack on the marked rods. The individual rods are 3 feet

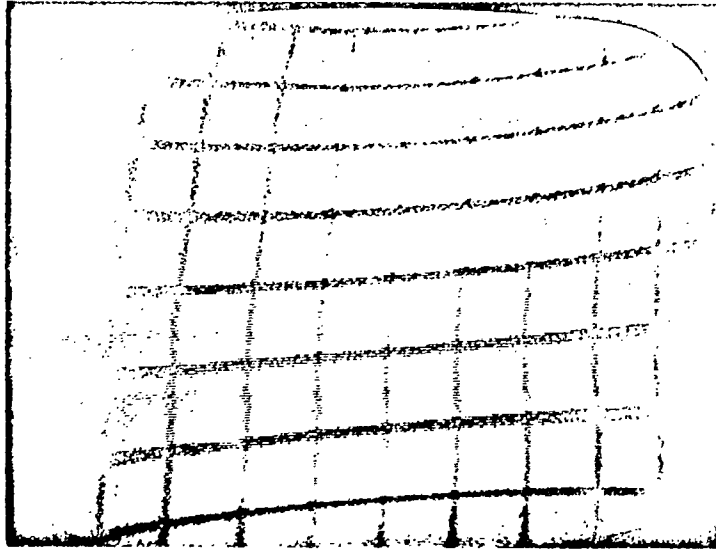

Figure A11.1. Measurements of slack in rod couplings.

in length and are equipped with a very secure and easily engaged coupling. Since the viewing was done in sub-horizontal holes, the rotational and axial friction on the camera and the rods was at a maximum. Measurements of slack in the couplings are summarized in Table A11.1. As the camera was pushed into the hole, the trailing cable was taped to the rods about every 15 feet. This explains the significant difference of the axial slack per coupling observed

TABLE A11.1  
Slack in Rod Couplings

|                                      | Axial | Rotational |
|--------------------------------------|-------|------------|
| Per coupling                         | 1/8"  | 10°        |
| Per 100 ft of rods<br>(33 couplings) | 2½"   | 400°       |
| Average per coupling                 | 1/16" | 12°        |

and the average slack over 33 couplings. The rotational slack became quite evident as viewing progressed in one of the deeper holes. On the screen, small sand-size grains could be seen rolling down the side and coming to rest on the bottom at the same time the operator pushing the camera was sure that the camera was facing up. Positioning errors due to axial and rotational slack in the couplings could be reduced by attaching a tape measure to the camera and by mounting some dip- or trend-measuring device. Both methods have been used with the Ontario Hydro television camera in vertical holes. The accuracy obtained, however, is unknown.

The data necessary for a geologic investigation differ markedly from those required for fabric analysis. A geologic investigation is concerned with the spatial distribution of lithologic units, whereas fabric analysis deals with the discontinuities in the rock mass. The data required for fabric analysis are: size, surface morphology and orientation of individual discontinuities, and density and grouping of fracture sets.

Information obtained from down-hole viewing is limited to:

- lithology - only on a broad comparative basis;
- orientation - provided that positioning errors are minimized;
- density and grouping - only if the fracture set is not sub-parallel to the axis of the hole.

In addition, television logging allows us to view the opening of discontinuities in situ. Surface morphology cannot be determined. In comparison, core logging gives excellent data on surface morphology of discontinuities and lithology; information about the density and grouping of fractures is again limited by the relative position between drill hole and fractures.

If the fabric of a rock mass is to be analyzed from drill-hole information, television and core logging have to be combined, or oriented core has to be extracted. Television logging, alone, is not sufficient to obtain the data necessary for a geologic investigation or fabric analysis.

## APPENDIX XII: INSTRUMENTATION COSTS

(Table A12.1)

| ITEM   | UNIT COST                                     | TOTAL COST  |
|--|---|---|
| 1. <u>Load Cells</u><br>Manufacture of 5 load cells (1 spare),<br>500,000-lb capacity  | \$500   | 2,500.00  |
| 2. <u>Extensometers</u><br>Manufacture of 4 multiwire extensometer<br>heads<br>Manufacture of 16 borehole anchors<br>Diamond drilling of extensometer holes:<br>(a) 211 drill hours (drill & crew of two)<br>(b) Demobilization<br>(c) Setting and diamond bit replacement<br>costs<br>Total diamond drilling costs = \$5182.70 for<br>823 ft BX drilling<br>Average cost = \$6.43/ft                              | \$900<br>\$ 30<br>\$13.50/hour<br>\$1.00/mile | 3,600.00<br>480.00<br>2,848.50<br>431.00<br>1,903.20                                  |
| 3. <u>Television Survey</u><br>Contract for television viewing of cable anchor<br>holes, including photography, living expenses<br>for crew, insurance, etc.   |   | 1,809.50  |
| 4. <u>Concrete gauges</u><br>Purchase 12 concrete strain gauges  | \$ 24.00                                      | 288.00  |
| 5. <u>Plate load tests</u><br>Purchase 24 dial gauges<br>Purchase 8 aluminum beams   | \$ 15.00<br>14.00                             | 360.00<br>112.00  |
| 6. <u>Cable, junction boxes and readout equipment</u><br>1000 ft 11 pair cable<br>500 ft 9 conductor cable<br>500 ft 5 conductor cable<br>Junction boxes, switch box, terminal strips, etc.<br>Multi-bank switch<br>Cable connections and plugs (submersion-proof<br>type)<br>Manufacture of telephone for cable checking<br>Vibrating wire read-out unit, type PC101<br>Galvanometric potentiometer read-out unit |   | 261.00<br>122.00<br>67.00<br>125.40<br>70.00<br>980.00<br>200.00<br>1775.00<br>370.00 |
|  | TOTAL   | 18,302.60   |



209  
not  
published

