

Diane Charbonneau

DESIGN OF A NEW MACROSEISMIC MONITORING SYSTEM

A. Makuch

**Mineral and Energy Technology
Mining Research Laboratories**

**CANADA AWARDS
FOR EXCELLENCE
1986**

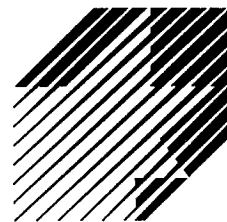

**SILVER AWARD
IN TECHNOLOGY
TRANSFER**

**CANMET Special Publication
SP86-14E**

©Minister of Supply and Services Canada 1987

Available in Canada through

Associated Bookstores
and other booksellers

or by mail from

Canadian Government Publishing Centre
Supply and Services Canada
Ottawa, Canada K1A 0S9

Catalogue No. M38-15/86-14E

Canada: \$3.75

ISBN 0-660-12496-3

Other Countries: \$4.50

Price subject to change without notice

All rights reserved. No part of this publication may be reproduced, stored in a retrieval system, or transmitted by any means, electronic, mechanical, photocopying, recording or otherwise, without the prior written permission of the Publishing Services, Canadian Government Publishing Centre, Ottawa, Canada K1A 0S9.

FOREWORD

The Canada - Ontario - Industry Rockburst Project was initiated through a "Memorandum of Understanding" which was signed in September, 1985. The goals of the project are to develop improved Canadian capabilities in rockburst monitoring, analysis, and prevention. To accomplish these, a team of specialists is being assembled at the Mining Research Laboratories facilities at Elliot Lake, Ontario, which will be available on a national basis to serve industry needs.

This report is one of the first outputs of the new project. In the interests of technology transfer, it, and subsequent reports, will be published in a format which will encourage the broadest possible distribution.

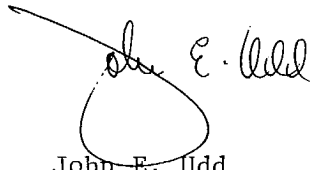
A handwritten signature in cursive script, appearing to read "John E. Udd". The signature is written in black ink and is positioned above the printed name.

John E. Udd
Director
Mining Research Laboratories

AVANT-PROPOS

Le projet Canada-Ontario-Industries sur les coups de toit a été entrepris grâce à un "mémoire d'entente" qui a été signé en septembre 1985. Les buts de ce projet sont de développer une expertise canadienne accrue dans les domaines du contrôle, de l'analyse et de la prévention des coups de toit. Pour atteindre cet objectif, une équipe de spécialistes a été rassemblée au laboratoire d'Elliot Lake des Laboratoires de recherche minière.

Le présent rapport est un des premiers résultats provenant de ce nouveau projet. Dans le but de promouvoir un transfert de technologie, ce rapport ainsi que ceux qui suivront seront publiés dans un format qui encouragera la plus vaste distribution possible.

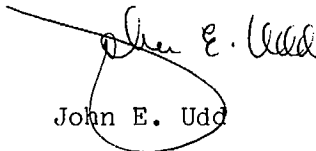

John E. Udd
Directeur

Laboratoires de recherche minérale

DESIGN OF A NEW MACROSEISMIC MONITORING SYSTEM

by

A. Makuch*

ABSTRACT

The recent incidence of rockburst activity in Sudbury area mines, both "Pillar Bursts" and "Fault Slip", has indicated the need for more intense analysis of the seismic waveforms from rockbursts. To facilitate this, a high speed data acquisition system capable of capturing complete seismic waveforms from the geophone signals in real time is required. The seismic waveforms could then be displayed on the computer screen for analysis.

As part of the CANADA/ONTARIO/INDUSTRY rockburst research project, it was proposed to design a "macroseismic monitoring system" for installation at both Falconbridge's Strathcona Mine and INCO's Creighton Mine in Sudbury. The first of these systems is to be installed at Strathcona Mine.

A comprehensive investigation of the existing state of the art in seismic detection/waveform recording systems was done prior to development of the system.

The Strathcona Mine seismic system will use five triaxial accelerometers, installed both on surface and underground. Geophone signals will be transmitted to a central microcomputer system where A/D conversion and event detection will be done. The digitized event files from all 15 sensors will be stored on disk on an IBM-PC/AT computer. Using modem communications, the seismic event files will be uploaded to a STRIDE minicomputer at the CANMET Mining Research Laboratory in Elliot Lake, Ontario. Analysis of the seismic waveforms, including peak particle velocity, first motion, spectral distribution, source location and seismic energy will be done at the Elliot Lake Laboratory. Also, the seismic waveforms can be analyzed on the on-site IBM-PC/AT computer.

Keywords: Rockbursts; Seismicity; Waveform analysis.

*Ground Control Engineer, Elliot Lake Laboratory, CANMET, Energy, Mines and Resources Canada, Elliot Lake, Ontario.

CONCEPTION D'UN NOUVEAU SYSTÈME DE SURVEILLANCE MACROSISMIQUE

par

A. Makuch*

RÉSUMÉ

L'incidence récente des coups de toit dans la région minière de Sudbury, soit les "effondrements de piliers" et les "coups de faille", a mis en lumière le besoin d'analyses plus poussées dans le domaine des ondes sismiques provenant des coups de toit. Dans ce but, un système d'acquisition de données à haute résolution est requis, de façon à capter en temps réel l'ensemble des ondes sismiques provenant des sismographes. Ces ondes sismiques pourront ainsi être affichées directement sur l'écran de l'ordinateur pour analyse.

Dans le cadre du projet de recherche CANADA/ONTARIO/INDUSTRIE sur les coups de toit, il a été proposé de créer un "système de surveillance macrosismique" qui sera installé aux mines Strathcona de la Falconbridge et Creighton de l'INCO, toutes deux dans la région de Sudbury. Le premier de ces deux systèmes sera installé à la mine Strathcona.

Comme il se doit, une investigation a été faite avant le développement du système, pour apprécier l'état actuel des connaissances dans le domaine des systèmes de détection et d'enregistrement des ondes sismiques.

Le système sismique de la mine Strathcona utilisera cinq accéléromètres axiaux qui seront installés tant en surface que sous terre. Les signaux des sismographes seront transmis à un micro-ordinateur central où la conversion A/D et la détection des événements seront effectuées. Les fichiers des

Mots-clés: Coups de toit; sismicité; analyse des ondes sismiques.

*Ingénieur de contrôle au sol, Laboratoire d'Elliot Lake, CANMET, Énergie, Mines et Ressources, Canada, Elliot Lake, Ontario.

événements provenant de l'ensemble des 15 détecteurs seront emmagasinés sur disque sur un ordinateur IBM-PC/AT. Utilisant les communications par modems, les fichiers des événements sismiques seront téléchargés à un micro-ordinateur de type STRIDE aux Laboratoires de recherche minière de CANMET à Elliot Lake en Ontario. L'analyse des ondes sismiques, ce qui inclut la vitesse de pointe des particules, le premier mouvement, la distribution spectrale, la localisation du foyer et l'énergie sismique, sera faite au Laboratoire d'Elliot Lake. Enfin, les ondes sismiques peuvent être analysées sur place avec l'ordinateur IBM-PC/AT.



CONTENTS

| | <u>Page</u> |
|---|-------------|
| FOREWORD | i |
| AVANT-PROPOS | ii |
| ABSTRACT | iii |
| RÉSUMÉ | iv |
| INTRODUCTION | 1 |
| SYSTEM DEVELOPMENT | 2 |
| Design Considerations | 4 |
| STRATHCONA MINE SEISMIC SYSTEM | 6 |
| General Characteristics | 6 |
| DISCUSSION OF SYSTEM COMPONENTS | 13 |
| Geophone Sensors | 13 |
| Signal Cable | 13 |
| On-Site Data Acquisition Microcomputer System | 15 |
| Elliot Lake Laboratory: Analysis System | 15 |
| REFERENCES | 19 |

TABLE

No.

| | |
|--|---|
| 1. Summary of rockbursts at Strathcona Mine, January 1985 to August 1986 | 3 |
|--|---|

FIGURES

| | |
|---|----|
| 1. Surface plan of Strathcona Mine showing sensor locations | 7 |
| 2. Plan of 2375 level showing sensor location | 8 |
| 3. Plan of 2750 level showing sensor location | 9 |
| 4. Layout of underground sensors | 11 |
| 5. Layout of surface sensors | 12 |
| 6. Cable assignments | 12 |
| 7. Frequency response, accelerometer type S100 (Teledyne - Geotech) | 14 |
| 8. Block diagram of data acquisition - microcomputer system | 16 |
| 9. Slave unit block diagram | 17 |

INTRODUCTION

Present state-of-the-art in rock noise detection/rockburst monitoring systems in Ontario mines is the Electro-Lab MP-250 microseismic monitor. Based on recognition of seismic P-wave arrivals to successive geophones in an underground array, the MP-250 was designed for real time detection and source location of seismic activity emanating from rock failures. The ability of the MP-250 system to determine the location of these seismic events has been useful for increasing our understanding of the causes of rockbursts in underground mines, along with aiding in the design of remedial mining plans to control their occurrence.

Three distinct types of rockbursts have been identified as occurring in underground mines, based on their relationship to different mechanisms of rock failure. "Pillar Bursts" or violent failure of underground rock pillars, are the most frequent type recognized in mines, and are in a sense our original definition of rockbursts. "Strain Energy" type bursts are a result of local failure of a volume of rock immediately adjacent to underground openings, and are usually of lower energy magnitude than pillar bursts. The third type, "Fault Slip Bursts", usually occur as a result of slippage along pre-existing geological discontinuities and faults.

Both "Pillar Bursts" and "Strain Energy Bursts" are a result of high stress concentrations in the rock. Associated trends in seismic activity can usually be recognized using the MP-250 source location system. When these results are used with stress analysis models and underground observations of rock deterioration, a better picture of the causes of these types of rockbursts can be derived. However, fault slip type rockbursts need not be associated with a buildup of rock stress, but could be the result of the removal of confining or clamping forces along a geological weakness plane. As such, associated trends in microseismic activity and rock deterioration may

not be recognized with these types of failures. In order to be able to fully study the occurrence of these types of rockbursts, more information must be derived from the seismic waveforms than source location alone.

As part of the CANADA/ONTARIO/INDUSTRY agreement on rockburst research in Ontario mines, it was proposed to design a "macroseismic monitoring system" capable of capturing the complete seismic waveform from rockbursts. Information derived from the seismic waveforms including, first motion of failure, peak particle velocity, frequency analysis, event magnitude and source location, would be useful in our study of all rockbursts, particularly "Fault Slip Bursts".

Recent occurrences of rockburst activity in the Sudbury area mines have been recognized as being related to fault slip failure (5). At Falconbridge's Strathcona mine, 20 rockbursts were recorded by the Eastern Canada Seismic Network stations from February/85 to August/86 (see Table 1). Local magnitudes of these rockbursts ranged from 1.5 to 3.1. Information obtained from the MP-250 microseismic monitoring system at the mine along with underground observations, have indicated that much of this rockburst activity may be associated with "Fault Slip" type failure along a dyke plane and associated structures. Source location of much of this seismic activity shows a relationship with a diabase dyke that crosscuts the west end of the orebody on the 2375 level horizon.

Because of this, a decision was made to install the first macroseismic monitoring system at Strathcona mine.

SYSTEM DEVELOPMENT

Prior to implementation of the "macroseismic monitoring system", a familiarization with the existing state-of-the-art in seismic detection and waveform recording systems was done. This included visits and technical

Table 1 - Summary of rockbursts at Strathcona Mine
January 1985 to August 1986.

| No. | Date | Time | Magnitude |
|-----|----------|-------|-----------|
| 1 | 2/ 6/85 | 13:33 | 2.7 |
| 2 | 2/17/85 | 11:56 | 1.7 |
| 3 | 2/23/85 | 0: 7 | 2.4 |
| 4 | 4/10/85 | 17:24 | 2.5 |
| 7 | 5/ 2/85 | 4:16 | 1.9 |
| 8 | 5/ 6/85 | 10: 2 | 2.2 |
| 12 | 11/ 9/85 | 5:41 | 2.2 |
| 13 | 11/17/85 | 9:57 | 2.7 |
| 14 | 11/19/85 | 11:45 | 2.2 |
| 15 | 12/18/85 | 5:46 | 2.3 |
| 16 | 12/21/85 | 15:32 | 3.1 |
| 17 | 12/24/85 | 18:40 | 1.8 |
| 18 | 12/24/85 | 20: 2 | 1.5 |
| 19 | 12/26/85 | 1:25 | 2.1 |
| 20 | 1/ 6/86 | 10:56 | 1.8 |
| 21 | 1/ 7/86 | 22:28 | 2.3 |
| 22 | 1/16/86 | 4:15 | 1.9 |
| 23 | 1/23/86 | 4:15 | 1.9 |
| 24 | 1/31/86 | 9:29 | 1.4 |
| 25 | 2/ 3/86 | 14:16 | 2.2 |
| 26 | 5/13/86 | 21: 5 | 2.6 |
| 27 | 5/13/86 | 21:42 | 1.9 |
| 28 | 5/14/86 | 3:58 | 2.9 |
| 30 | 7/17/86 | 0:24 | 2.3 |
| 31 | 7/26/86 | 16:19 | 2.7 |
| 32 | 7/29/86 | 23:48 | 2.1 |
| 33 | 8/ 2/86 | 16:32 | 3.1 |

discussions with:

- EMR Geophysics Division in Ottawa;
- Noranda Research, Pointe Claire, Quebec;
- Instantel Inc, Kanata, Ontario;
- Falconbridge Mines, rock mechanics group, Sudbury, Ontario;
- INCO Mines, Mines Research, Sudbury, Ontario;
- Dr. Don Gendzwill, University of Saskatchewan;
- Allan Crawford Associates, Toronto, Ontario;
- Transduction Ltd, Data Translation, Toronto, Ontario;
- Electro-Lab, Spokane, Washington;
- Wilson Blake, Mine Engineering Consultant, Hayden Lake, Idaho;
- Lucky Friday, Galena and Sunshine mines, in Idaho.
- United States Bureau of Mines, Denver, Colorado;
- Sandia National Laboratories, Albuquerque, New Mexico;
- Teledyne Geotech, Dallas, Texas.

Following discussions with this group, preliminary design of a prototype "macroseismic monitoring system" to capture complete waveforms was reached.

DESIGN CONSIDERATIONS

1. The geophone network is to consist of five triaxial geophones installed at selected sites around the mine so as to be approximately 1 km from the rockburst-prone area. This distance was chosen to minimize saturation of the geophones from large seismic events. Selection of the sites for the geophone stations should take into consideration the design of an array which provides for optimum coverage for first motion studies.
2. The analog signals from the geophones will be transmitted to a host micro-computer where the analog to digital (A/D) conversion and seismic event detection will be done. Upon detection of a seismic waveform from any of

the geophone stations, a pretrigger data buffer along with the complete seismic waveform from each geophone sensor will be stored to disk. A real time clock will be required for synchronization of the geophone signals and recording the time of occurrence.

3. Frequency spectra of the seismic signals, measured 1 km from a rockburst, should be in the 0.1-100 Hz range, with a predominance of signal below 40 Hz. Also, the expected corner frequencies derived from the seismic waveform analyses should be between 0.8-10 Hz (3).

The dynamic range of the sensors should be sufficient to enable measurements of rockbursts from 0 - 3.5 magnitude with minimum loss in resolution.

With this in mind, digital sampling at a rate of 1000 Hz with 12 bit A/D accuracy (72 dB dynamic range) is required. Strong motion accelerometers with a flat response between 0.5-1000 Hz were chosen as the sensor system.

4. Interpretation and analysis of the seismic waveform data will be done on a remote computer located at the CANMET Laboratory in Elliot Lake. Access from the remote to on-site computer will be done using a modem link. As such, the on-site microcomputer must have a compatible software interface to either a STRIDE UNIX System V or PDP11/RSX11M operating system.

Data analysis of the seismic waveforms will include;

- Display of the waveforms to computer screen and hard copy;
- Rockburst location using P and S wave arrivals;
- First motions for interpretation of failure mechanism;
- Peak particle velocity at each geophone;
- Seismic energy released and event magnitude;
- Spectral analysis, corner frequency, etc.

STRATHCONA MINE SEISMIC SYSTEM

GENERAL CHARACTERISTICS

Falconbridge's Strathcona Mine is located in the northwest rim of the Sudbury Basin. Underground mining of the nickel-sulfide orebody is done using mechanized post-pillar cut-and-fill, with some sublevel blasthole stoping in an alternate stope/pillar layout.

The macroseismic monitoring to be installed at Strathcona mine is to consist of five triaxial geophone stations, three located on surface, and two underground. (Figures 1, 2 and 3). The central microcomputer will be located in the Ground Control engineering office at the Strathcona mine site. Choosing of the sites for the geophone stations was done in consultation with Falconbridge Ltd. The geophones are designed to monitor failure associated with the diabase dyke, as mentioned earlier. The locations of the geophone sites are as follows:

- SS1 - surface installation on the mine site, adjacent to the powder magazine, on the footwall side of the dyke. Installed at a depth of 6 metres in a 100 mm diameter vertical borehole.
- SS2 - surface installation on the Fraser mine site, near the tailing pipeline on the footwall side of the dyke. Installed at a depth of 6 metres in a 100 mm diameter vertical borehole.
- SS3 - surface installation on the Strathcona minesite adjacent to the watertower on the hanging wall side of the dyke. Installed at a depth of 6 metres in a 100 mm vertical borehole.
- SS4 - Underground at Strathcona Mine, 2375 level (Figure 2) on the hanging wall side of the dyke. Installed at a depth of 2 metres in a horizontal 100 mm borehole.
- SS5 - Underground at Strathcona Mine, 2750 level (Figure 3) on the footwall

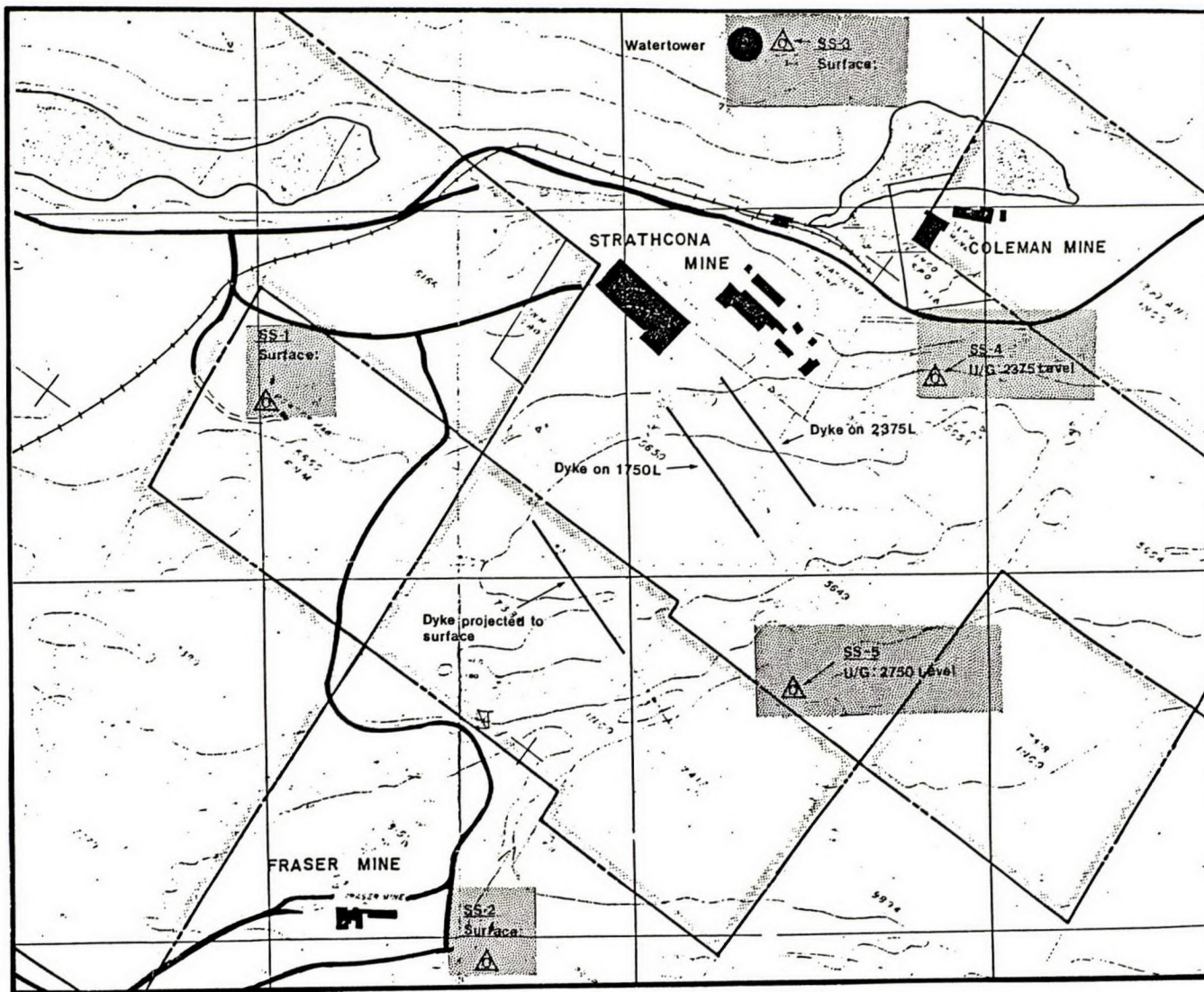

Fig. 1 - Surface plan of Strathcona Mine showing sensor locations.

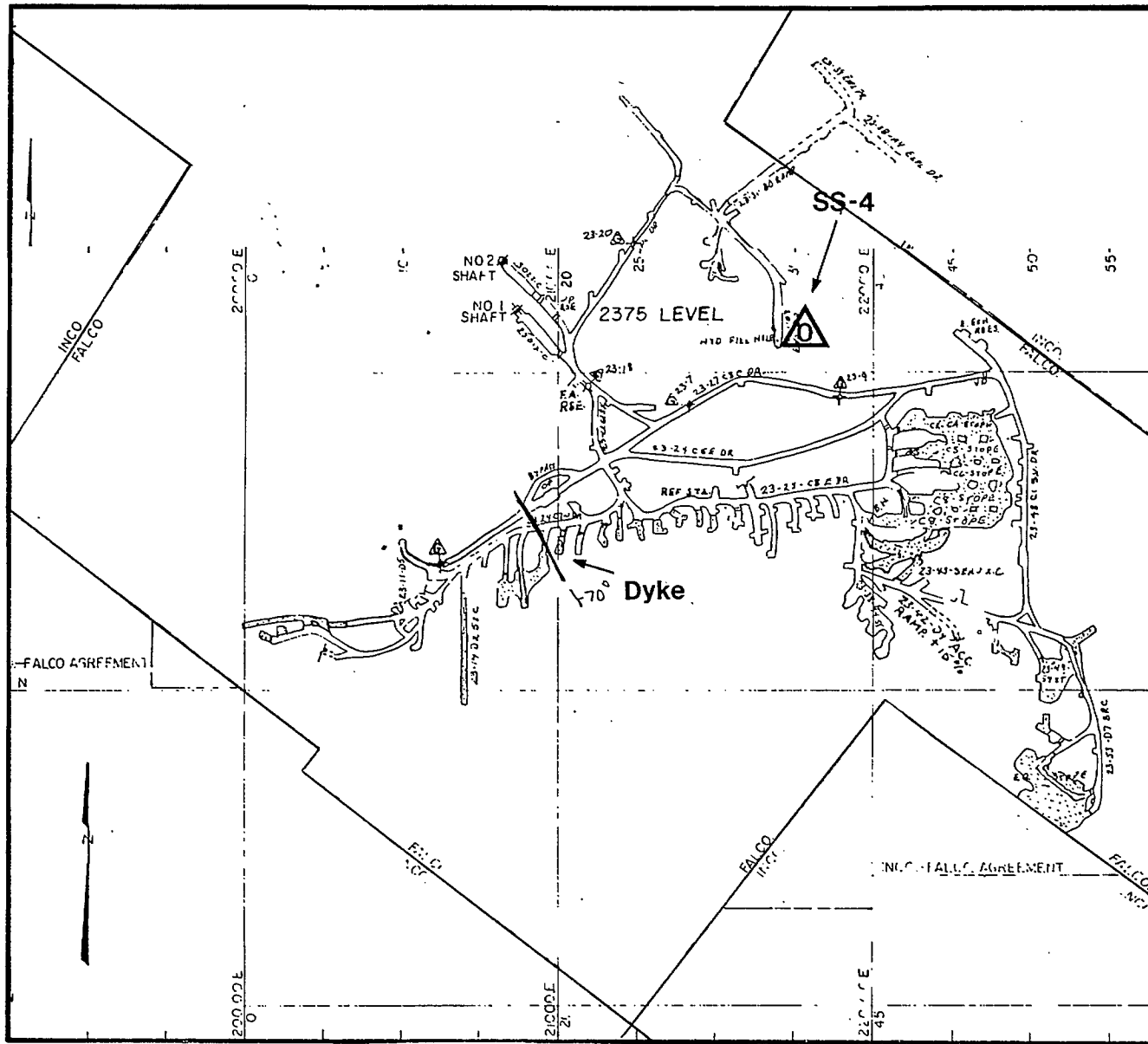

Fig. 2 - Plan of 2375 level showing sensor location.

side of the dyke. Installed at a depth of 2 metres in a horizontal 100 mm borehole.

Figure 4 shows the installation procedure to be used for the underground geophone stations, and Figure 5 shows the surface installations.

The geophone signals will be transmitted in analog form from each seismic station to individual signal processing units or slave processors, located in the engineering office. Each slave unit will be responsible for preprocessing of the seismic signals from one triaxial geophone; therefore five slave processor units will be required. Preprocessing of the geophone signals at each slave unit will include:

- A/D conversion at 4 kHz/channel, 12 bit accuracy;
- event trigger detection;
- event timing from a central real time clock;
- pre-event buffering.

A serial multiplexer will be used to interface each slave processor to an IBM-AT microcomputer, responsible for event handling and data storage. Communications software using x-modem protocol will reside on both the on-site IBM/AT and on the STRIDE minicomputer at the Elliot Lake Laboratory. Uploading of the event data files from the IBM/AT to the STRIDE will be done using asynchronous modems at a rate of 2400 bps. Users at the Elliot Lake Laboratory will call up the on-site IBM/AT on a regular basis to upload the files.

Each geophone station at the mine site will require 12 volts DC power for the charge amplifier circuit included in the borehole package. In order to keep the system simple, a central 12 V DC power supply will be located in the office with the data acquisition and on-site microcomputer. Figure 6 shows the required assignments for the 6 pair (12 conductor) wires used for data and power transmission between the geophone stations and the central computer

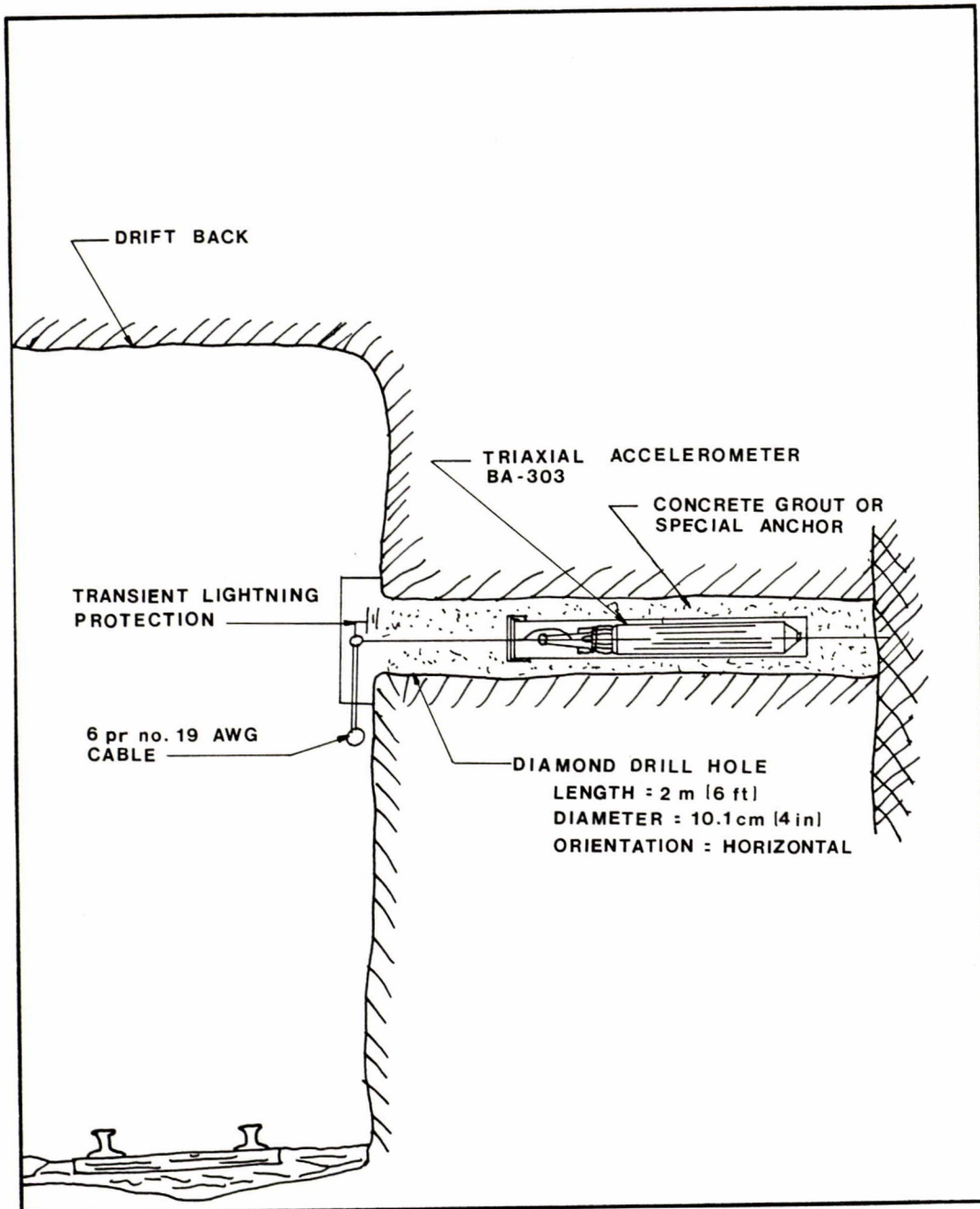

Fig. 4 - Layout of underground sensors.

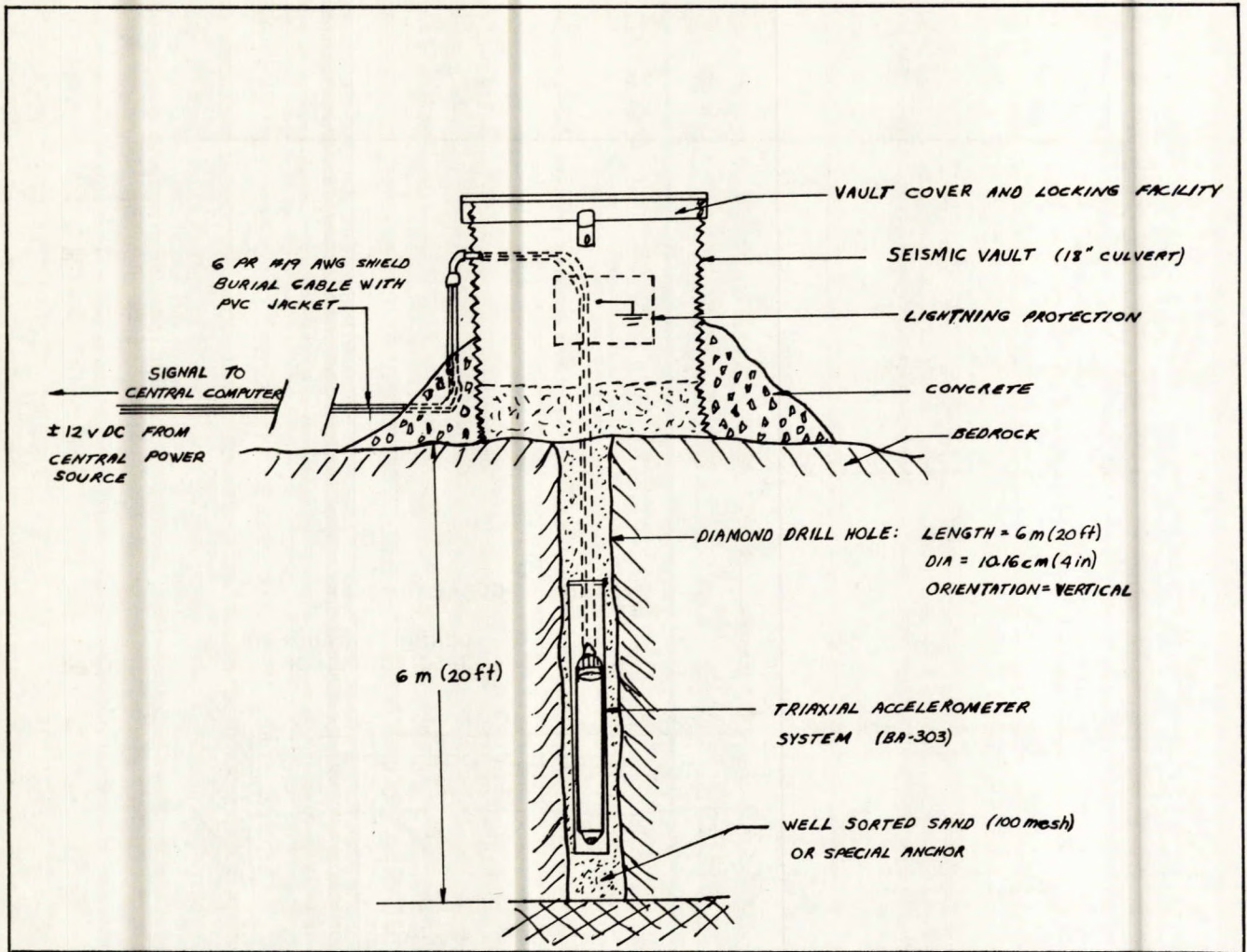

Fig. 5 - Layout of surface sensors.

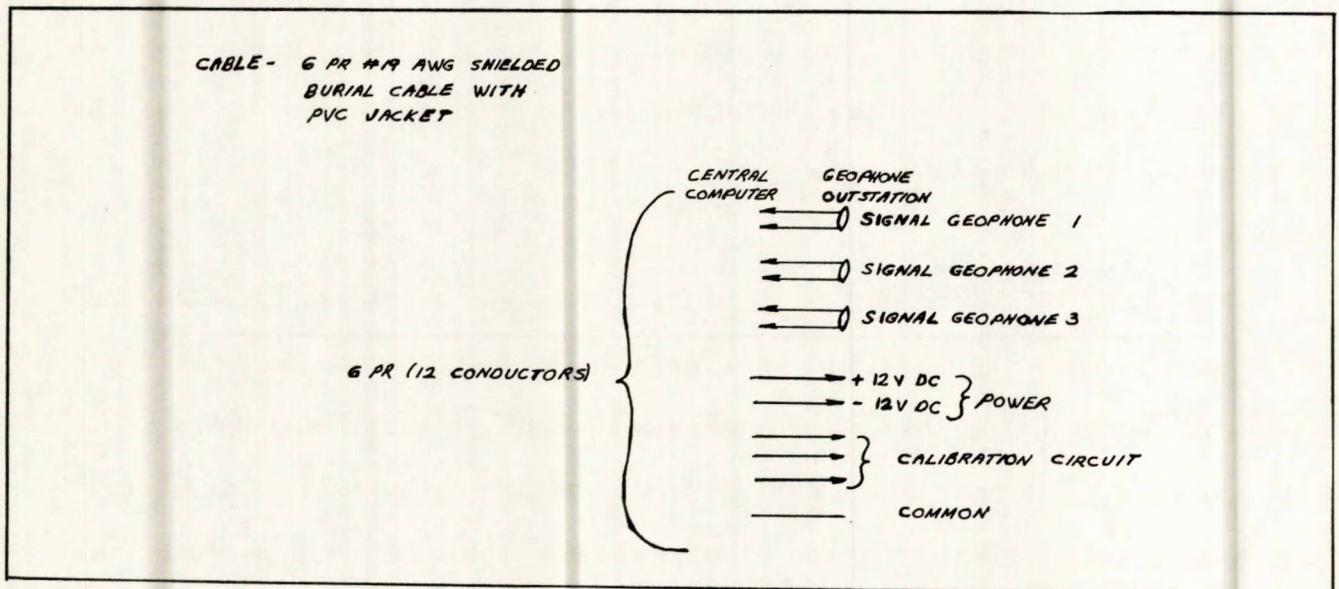

Fig. 6 - Cable assignments.

site. Transient voltage/lightning protection will be required on each wire pair at both ends of the line, at the collar of the borehole and at the microcomputer slave processor inputs. From the wiring assignments, 7 inputs to the surge protector will be required for each end of the wires, or a total of 70 protected channels. Also, an uninterruptible power conditioner and surge suppressor will be installed on the power side of the on-site microcomputer and data acquisition system.

DISCUSSION OF SYSTEM COMPONENTS

GEOPHONE SENSORS

The model BA-303 three axis borehole mounted S-100 accelerometers manufactured by Teledyne Geotech, will be used. The S-100 is a force balanced accelerometer with a frequency response of 0.01-2000 Hz. The output sensitivity of the accelerometer/amplifier assembly is 20 volts/g, and gives a full scale signal capability of ± 0.5 g. Figure 7 shows the frequency response of the S-100 accelerometer system. A calibration circuit is included with the BA-303 for checking the accelerometer response from the microcomputer.

Each geophone/accelerometer package comes with 8 m of cable. At the collar of each borehole, the transient surge protection system will be installed where the cable is connected to the main signal cable from the central microcomputer system.

SIGNAL CABLE

Six No. 18 AWG twisted pair corrugated copper shielded, burial cable, will be run from the central computer site to each of the three surface geophone stations. For the two underground stations, the existing shaft cable will be used. Six pair cable must be run from the shaft stations to each of the underground sites (2375 and 2750 levels). Therefore, 12 pairs of the existing 75 pair shaft cable will be required for the system.

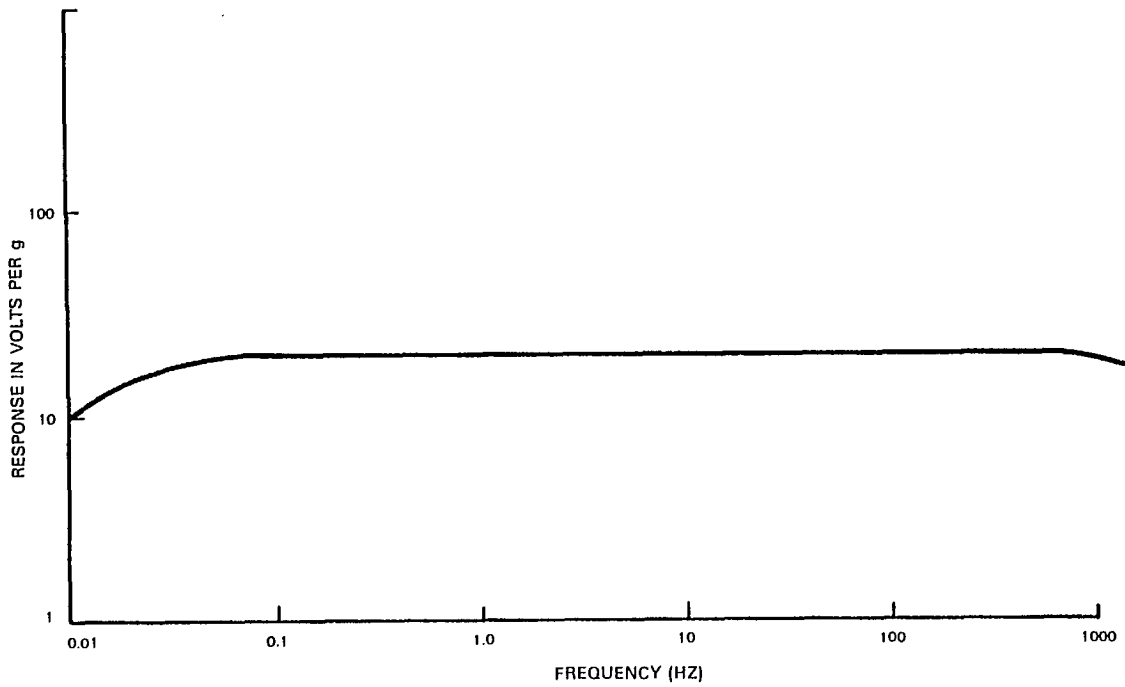

Fig. 7 - Frequency response, accelerometer type S100
(Teledyne - Geotech).

ON-SITE DATA ACQUISITION MICROCOMPUTER SYSTEM

Components for this portion of the system are shown in Figure 8 and will be supplied by InstanTel Inc. of Kanata, Ontario. These will include:

- Five DS200 Seismic Signal Processing Units/Slave Processors each consisting of a 80186 CPU at 8 MHZ, 512kB RAM, 12 bit A/D with 4 kHz sampling/channel, 3 channel inputs, and seismic event trigger logic, (Figure 9);
- Eight channel serial multiplexer system and software for interfacing the DS200's to the IBM-PC/AT microcomputer;
- IBM-PC/AT microcomputer with DS500 seismic system software, and communication software. The IBM-PC/AT specifications include 512kB RAM, dual speed processor, 20 MB hard disk drive, 1.2 MB floppy disk drive, real time clock, serial/parallel adapter, high resolution graphics, monitor and keyboard;
- System printer;
- Gandalf access series 24 intelligent supermodem- 2400 BAUD, Hayes compatible.

Also included with the central on-site microcomputer system will be a 12 V DC supply for power to the accelerometers, and an uninterruptible power supply, conditioner and transient surge suppressor.

ELLIOT LAKE LABORATORY: ANALYSIS SYSTEM

At the Elliot Lake Laboratory, a second GANDALF 24S modem will be installed on the STRIDE minicomputer. Communications software for uploading of files from the on-site IBM-PC/AT will be included as part of the package supplied by InstanTel Inc.

Software for display and analysis of the seismic waveforms will initially reside on the PDP11/23 minicomputer at the Laboratory. This will include the ILS-DACS signal analysis software. Subsequently, the source code

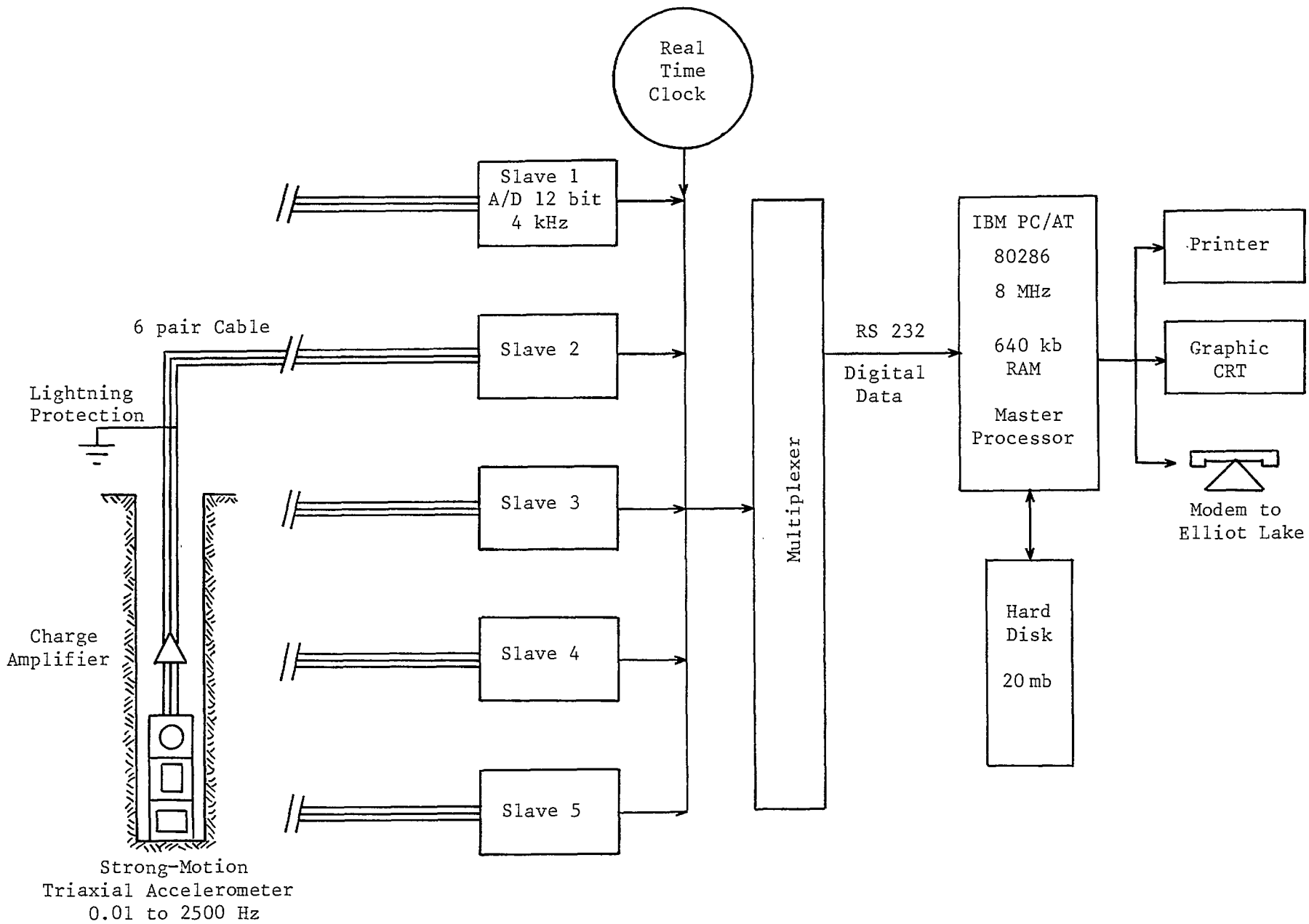

Fig. 8 - Block diagram of data acquisition - microcomputer system.

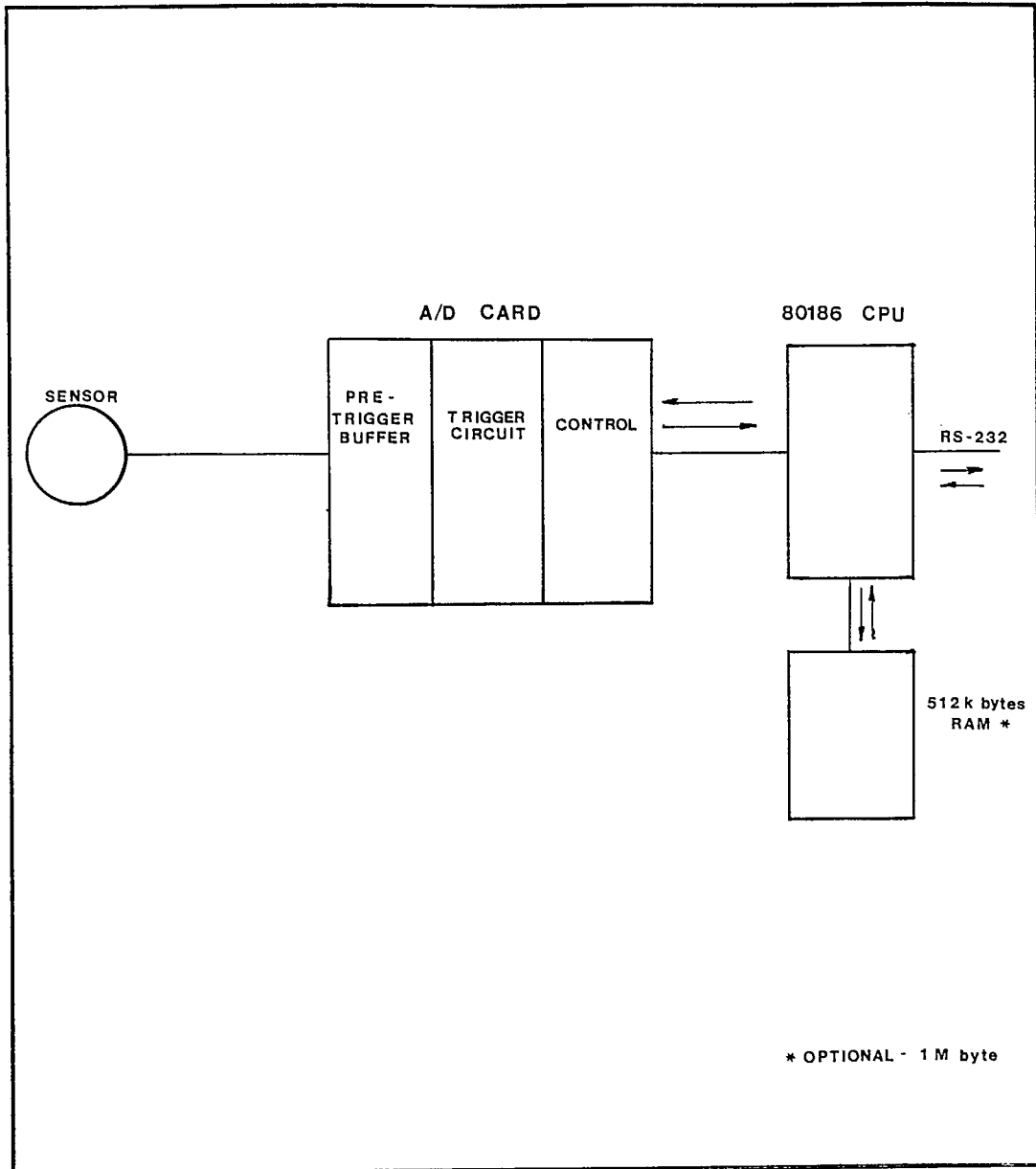

Fig. 9 - Slave unit block diagram.

software can be transferred to the STRIDE minicomputer. Since all the source code is in FORTRAN-77, this should not prove to be too much of a problem. Also, graphics for the ILS software is written for the Tektronix 4014 emulation. Since a majority of the computer displays at the Laboratory are Tektronix compatible, this software should be compatible with little front end development.

The digitized seismic waveform files received from the DS-200's may have to be converted to compatible format for the ILS software. This should not be a difficult task.

REFERENCES

1. Blake, W., "Design considerations for seismic monitoring systems"; Proc. of 1st Int. Congr. on Rockbursts and Seismicity in Mines, Johannesburg 1982. SAIMM Johannesburg 1984.
2. Gibowicz, S. J., "The mechanism of large mining tremors in Poland"; Proc. 1st Int. Congr. on Rockbursts and Seismicity in Mines, Johannesburg 1982. SAIMM Johannesburg 1984.
3. Gibowicz, S. J., Cichowicz A., Dybel T., "Seismic moment and source size of mining tremors in Upper Silesia, Poland"; ACTA Geophysica Polonica, Vol. XXV, no. 3, 1977.
4. Green R.W.E., "Design considerations for an underground seismic network"; Proc. 1st Int. Congr. on Rockbursts and Seismicity in Mines; Johannesburg 1982. SAIMM Johannesburg 1984.
5. Hedley D.G.F., Bharti S., West D., Blake W., "Fault slip rockbursts at Falconbridge Mine"; Division Report 85-114(OP,J), CANMET, Energy Mines and Resources Canada; Sept. 1985.
6. Hedley D.G.F., "1985/86 annual report of the CANADA/ONTARIO/INDUSTRY rockburst research project"; Special Report 86-3E; CANMET, Energy Mines and Resources Canada; May 1986.
7. Teledyne Geotech Ltd., "Model 54100 3-component seismometer description and performance characteristics"; Product Information; Garland, Texas, March 1985.

