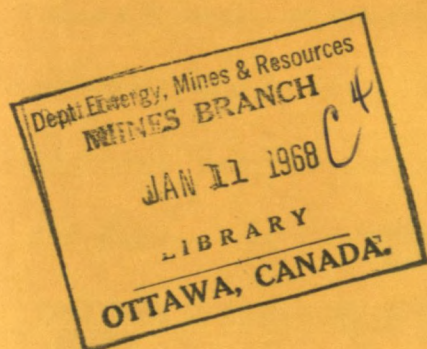




CANADA

DEPARTMENT OF  
ENERGY, MINES AND RESOURCES  
MINES BRANCH  
OTTAWA

*THE CONSTRUCTION, OPERATION AND  
PERFORMANCE OF AN EQUIPMENT  
FOR DIFFERENTIAL THERMAL ANALYSIS*



RICHARD H. LAKE

MINERAL SCIENCES DIVISION

AUGUST 1967



© Crown Copyrights reserved

Available by mail from the Queen's Printer, Ottawa,  
and at the following Canadian Government bookshops:

OTTAWA

*Daly Building, Corner Mackenzie and Rideau*

TORONTO

*221 Yonge Street*

MONTREAL

*Æterna-Vie Building, 1182 St. Catherine St. West*

WINNIPEG

*Mall Center Building, 499 Portage Avenue*

VANCOUVER

*657 Granville Avenue*

HALIFAX

*1737 Barrington Street*

or through your bookseller

A deposit copy of this publication is also available  
for reference in public libraries across Canada

Price 75 cents      Catalogue No. M34-20/92

*Price subject to change without notice*

ROGER DUHAMEL, F.R.S.C.  
Queen's Printer and Controller of Stationery  
Ottawa, Canada  
1967

Mines Branch Technical Bulletin TB 92

THE CONSTRUCTION, OPERATION AND PERFORMANCE OF AN  
EQUIPMENT FOR DIFFERENTIAL THERMAL ANALYSIS

by

Richard H. Lake\*

- - -

SYNOPSIS

A description is given of an equipment for use in differential thermal analysis. The equipment, which was designed and built in the Mines Branch, is capable of operating at high sensitivity and stability at temperatures up to 1600°C in air or in any controlled atmosphere at 1 atm. pressure, or in vacuum up to 1250°C. Details are given of the engineering specifications of the components and of precautions to be taken in order to obtain satisfactory operation. Typical DTA curves, showing the types of result that can be obtained with the equipment, are included. Possible sources of supply of the various components are quoted.

---

\*Technical Officer, Physical Chemistry Section, Mineral Sciences Division, Mines Branch, Department of Energy, Mines and Resources, Ottawa, Canada.

Direction des mines

Bulletin technique TB 92

FABRICATION, FONCTIONNEMENT ET RENDEMENT  
D'UN APPAREILLAGE D'ANALYSE  
THERMIQUE DIFFÉRENTIELLE

par

Richard H. Lake\*

-----

RÉSUMÉ

L'auteur donne une description d'un appareillage utilisé dans l'analyse thermique différentielle. L'appareillage, qui a été conçu et fabriqué à la Direction des mines, possède une haute sensibilité et une grande stabilité de fonctionnement à des températures allant jusqu'à 1600°C dans l'air ou dans toute atmosphère contrôlée à la pression d'une atmosphère, ou sous vide jusqu'à 1250°C. L'auteur donne des détails sur les prescriptions techniques des composantes et sur les précautions à prendre pour assurer un fonctionnement satisfaisant. Des courbes typiques d'analyse thermique différentielle sont jointes à l'ouvrage pour indiquer les genres de résultats qui peuvent être obtenus avec l'appareillage. L'auteur indique aussi les diverses sources d'approvisionnement pour les diverses composantes.

---

\* Agent technique, Section de la chimie physique, Division des sciences minérales, Direction des mines, Ministère de l'Énergie, des Mines et des Ressources, Ottawa, Canada.

CONTENTS

	<u>Page</u>
Synopsis .. .. .	i
Résumé .. .. .	ii
Introduction .. .. .	1
Description of the Construction of the Equipment .. .. .	4
A. The Sample Holder .. .. .	4
B. The Furnace Assembly .. .. .	6
C. The Furnace-Temperature Controller .. .. .	24
D. The Measuring and Recording Equipment .. .. .	33
Operation and Performance of the Equipment .. .. .	33
Availability of Items Used in the Construction of the Equipment .. .. .	39
Acknowledgements .. .. .	42

= = =

FIGURES

<u>No.</u>		<u>Page</u>
1.	Sample holder .. .. .	5
2a.	Set-up for static-air-atmosphere run .. .. .	7
2b.	Set-up for flowing-gas-atmosphere run .. .. .	7
2c.	Furnace construction (front view) .. .. .	9
2d.	Furnace construction (side view) .. .. .	10
2e.	Furnace construction (top view) .. .. .	11
2f.	Kanthal-element furnace .. .. .	13
2g.	Platinum/rhodium-element furnace .. .. .	15
3a.	Centering assembly (part one) .. .. .	19
3b.	Centering assembly (part two) .. .. .	20
4a.	Sample-holder tubes .. .. .	21
4b.	Thermocouple arrangement for flowing-gas or vacuum runs .. .. .	22
4c.	Carrier for sample holder and thermocouple assembly (Refractory tube, 3/4-in. O.D., cut as indicated) .. .. .	22
4d.	Thermocouple and sample-holder assembly installed in sample-holder tube .. .. .	23
5a.	View of worm-gear speed reducer and clutch .. .. .	26
5b.	View of temperature controller, showing arrangement of variable-speed drive, worm-gear speed reducer with clutch, and "Variac" auto-transformer .. .. .	26

<u>No.</u>							<u>Page</u>
5c.	Worm drive and clutch (part one)	..	..	..	..	..	29
5d.	Worm drive and clutch (part two)	..	..	..	..	..	31
6a.	DTA chart - Wyoming bentonite	..	..	..	..	..	36
6b.	DTA chart - Dolomite	..	..	..	..	..	37
6c.	DTA chart - Brazilian quartz	..	..	..	..	..	38

TABLE

1.	Conditions of Test in Typical DTA Examinations	..	..	..	..	..	35
----	--	----	----	----	----	----	----

= = =

Mines Branch Technical Bulletin TB 92

THE CONSTRUCTION, OPERATION AND PERFORMANCE OF AN  
EQUIPMENT FOR DIFFERENTIAL THERMAL ANALYSIS

by

Richard H. Lake

- - -

INTRODUCTION

The technique or process of Differential Thermal Analysis (DTA) involves, basically, the measuring and recording of the difference in temperature,  $\Delta T$ , between a test sample and an inert reference material caused by the occurrence of some phenomenon in the former while they are both being heated or cooled side-by-side, usually at a uniform rate. The curve obtained by the continuous plot of  $\Delta T$  as a function of the changing environmental temperature,  $T$ , will be a record of any endothermic and/or exothermic changes, physical or chemical, that may occur in the sample during the heating process; these changes are characteristic of the sample under the conditions of the test. DTA may, therefore, be used as a diagnostic tool for qualitative analysis and, with careful standardization and calibration, may also be used on a quantitative basis.

The number of fields of scientific endeavour in which the application of the technique of Differential Thermal Analysis has proved to be of significant assistance in solving problems is continually expanding. This increasing demand has greatly stimulated development in the field of instrumentation and, as a result, DTA equipments that have many excellent features are now widely available commercially. The various manufacturers of scientific equipment have differed considerably in their approach to the problems encountered in designing differential thermal analysis equipment, and this is reflected in the variety of details of their apparatus. It is probable that no one commercially available unit has incorporated within it all the desirable features that can be found in the whole group of such units and, hence, the selection of a given unit would have to be made on the basis of the requirements for the particular application concerned. Commercially made DTA units range in size from small models that may be operated on a desk or table to large floor models, and vary in price from \$5000 or less to about \$20,000.

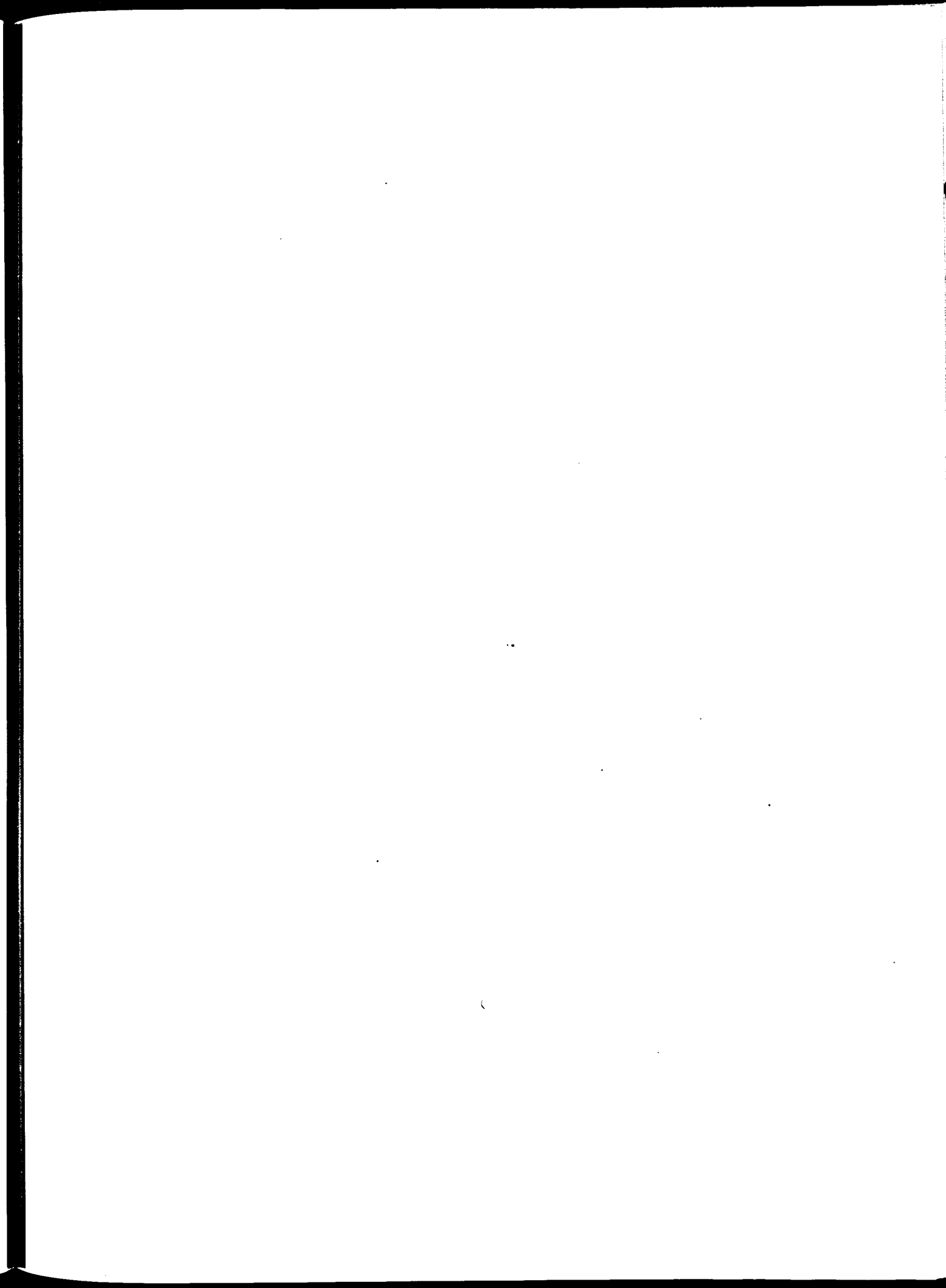


There are, no doubt, many laboratories in which the DTA method could usefully be applied but where, for various reasons, the expense of obtaining a commercial unit is not felt to be justified. Therefore, in an effort to assist those who may be contemplating the construction of their own equipment and in response to a number of requests, a DTA apparatus of simple construction and moderate cost, that has given excellent results, is described herein. This equipment was designed, primarily, for work with inorganic substances and contains many of the features commonly available in the commercial instruments. Modifications may be made according to individual needs. It may be of interest to note that the apparatus to be described herein, in its original form and when first constructed, was probably the first differential thermal analytical equipment to be built and operated in Canada.

For convenience the construction of the apparatus is discussed under the following headings:

- (a) The sample holder.
- (b) The furnace assembly.
- (c) The furnace-temperature controller.
- (d) The measuring and recording equipment.

Some comments on its operation and performance are then given, as well as details of available sources of supply of the necessary components and materials.



## DESCRIPTION OF THE CONSTRUCTION OF THE EQUIPMENT

### A. The Sample Holder

The design of the sample holder, shown in Figure 1, has proved to be very satisfactory. The holder contains two wells or cavities, one each for the sample and the reference material. Provision is made for inserting the junctions of the difference thermocouple elements into the exact centres of the sample and the reference material through holes drilled centrally into the wall of each cavity from one end of the holder. A third hole is also provided, between the wells, for the insertion of the ambient-temperature-measuring thermocouple. The geometry of this arrangement is such that, when the sample holder is situated in the centre of the uniform temperature zone of the furnace, the heat effect is equal on the sample, on the reference material and on the temperature-measuring thermocouple.

The composition of the material that is used for making the sample holder will, of course, depend on the nature of the samples under study and on the conditions of temperature and atmosphere likely to prevail during the course of the work. For analyses at temperatures up to about 1250°C, in any atmosphere except a hydrogen-containing one, sample holders made of palladium metal have been found most suitable. Palladium, like platinum, is inert to most substances, is stable in most atmospheres, and is readily cleaned. Consequently, a holder made of palladium can, with careful use, have a long life and will outlast several holders made of base metals or alloys, thus substantially lowering fabrication costs. Furthermore, palladium, like the other precious metals, has the added advantage of a fairly high recovery rate of the original cost of the metal when returned to the supplier as scrap. For studies up to a temperature of 1600°C, a sample holder made of a platinum/rhodium alloy, having a composition of either 80/20 or 70/30, is suitable. The above remarks concerning the use of palladium metal also apply to platinum/rhodium alloys. For work with samples, or under conditions, that would be injurious either to palladium metal or to Pt/Rh alloys, sample holders made of alumina have proved satisfactory. If necessary, the wells can be lined with platinum foil to prevent reaction between the sample and the alumina sample-holder.

Although it is preferable to have the metal sample-holders fabricated by the precious metal suppliers, the alumina sample-holders can readily be made in the laboratory. Ignited aluminum oxide powder of high grade and -200 mesh particle size may be used for this purpose. To make the sample holder, the alumina is first tempered to a good dry-press consistency with a solution of about 10% of an organic binder such as polyvinyl alcohol or gum tragacanth in water, and a blank in the form of a cylinder is then pressed. When dry, the cylinder is cut or ground to the shape and dimensions of the sample holder. The cavities for the sample and the reference material and the holes for the thermocouples are then drilled.

Before the sample holder is used, it should be fired in air to a high temperature, preferably to about 1600°C, and held at that temperature for about an hour to ensure good sintering to give a hard ceramic piece.

Drill two holes  $\frac{1}{4}$ " dia.  $\frac{1}{2}$ " deep

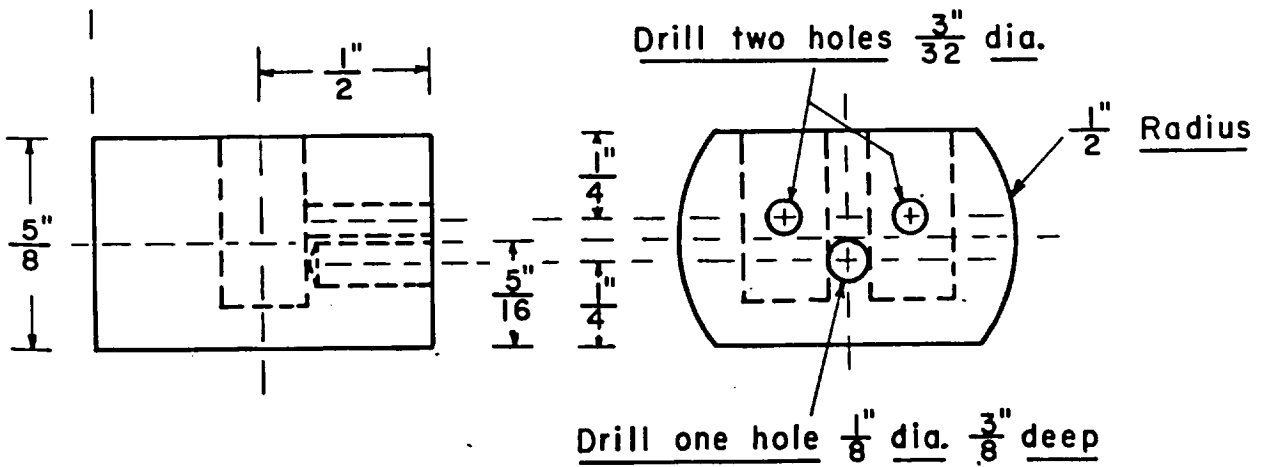
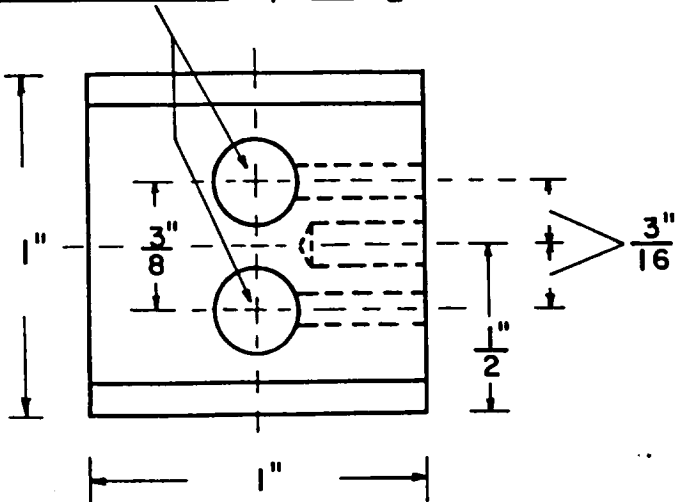
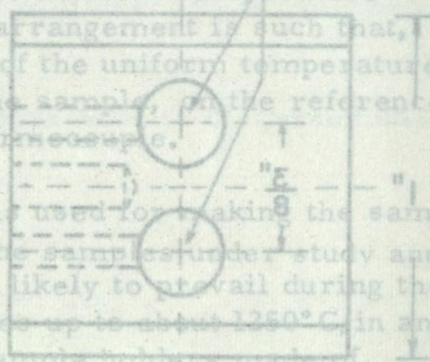


Figure 1. Sample holder.

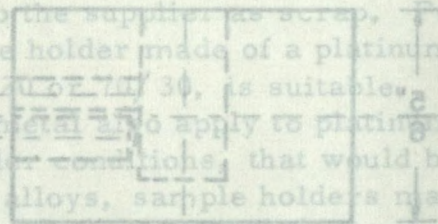
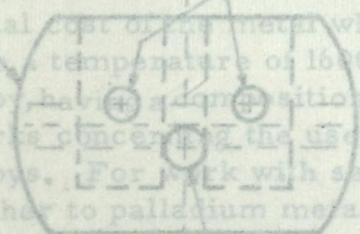
B. The Furnace Assembly

The furnaces used in the Mines Branch equipment are of the horizontal-tube type. The general construction and assembly are as shown in Figures 2a to 2g, inclusive. The furnace element is contained in a cylindrical shell which is clamped in a saddle that, in turn, is bolted to a platform on wheels and track. This permits the furnace to be moved back and forth, so that the tube supporting the sample holder may be inserted into and withdrawn from the furnace-element tube.

The junctions of the difference thermocouple elements into the exact centres of the sample and the reference material through two holes in the wall of each cavity from one end of the holder. A third hole is also provided, between the wells, for the insertion of the ambient-temperature-measuring thermocouple. The geometry of this arrangement is such that, when the sample holder is situated in the centre of the uniform temperature zone of the furnace, the heat effect is equal on the sample, on the reference material and on the temperature-measuring thermocouple.



The composition of the material that is used for making the sample holder will, of course, depend on the nature of the samples under study and on the conditions of temperature and atmosphere likely to prevail during the course of the work. For analyses at temperatures up to about 1250°C, in any atmosphere except a hydrogen-containing one, sample holders made of palladium metal have been found most suitable. Palladium, like platinum, is inert to most substances, is stable in most atmospheres, and is readily cleaned. Consequently, a holder made of palladium can, with careful use, have a long life and will outlast several holders made of base metals or alloys, thus substantially lowering fabrication costs. Furthermore, palladium, like the other precious metals, has the added advantage of a fairly high recovery rate



For studies up to a temperature of 1600°C a sample holder made of a platinum/rhodium alloy, with a composition of either 80/20 or 70/30, is suitable. The above remarks also apply to platinum/rhodium alloys. For work with samples, under conditions that would be injurious either to palladium metal or to Pt/Rh alloys, sample holders made of alumina have proved satisfactory. If necessary, the wells can be lined with platinum foil to prevent reaction between the sample and the alumina sample-holder.

Although it is preferable to have the metal sample-holders fabricated by the precious metal suppliers, the alumina sample-holders can readily be made in the laboratory. Ignited aluminum oxide powder of high grade and -200 mesh particle size may be used for this purpose. To make the sample holder, the alumina is first tempered to a good dry-press consistency with a solution of about 10% of an organic binder such as polyvinyl alcohol or gum tragacanth in water and a blank in the form of a cylinder is then pressed. When dry, the cylinder is cut to ground to the shape and dimensions of the sample holder. The cavities for the sample and the reference material and the holes for the thermocouples are then drilled.

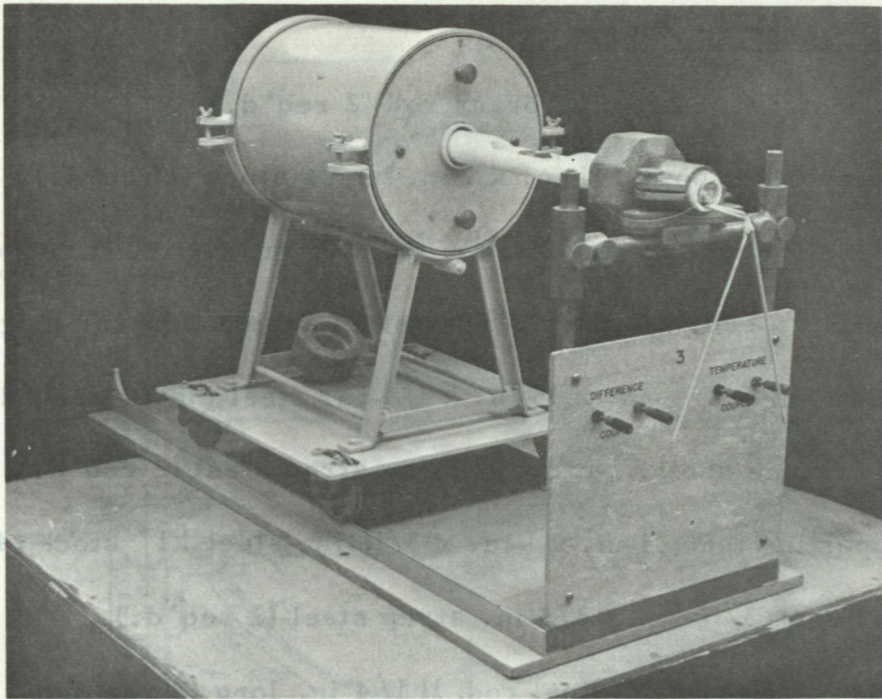


Figure 2a. Set-up for static-air-atmosphere run.

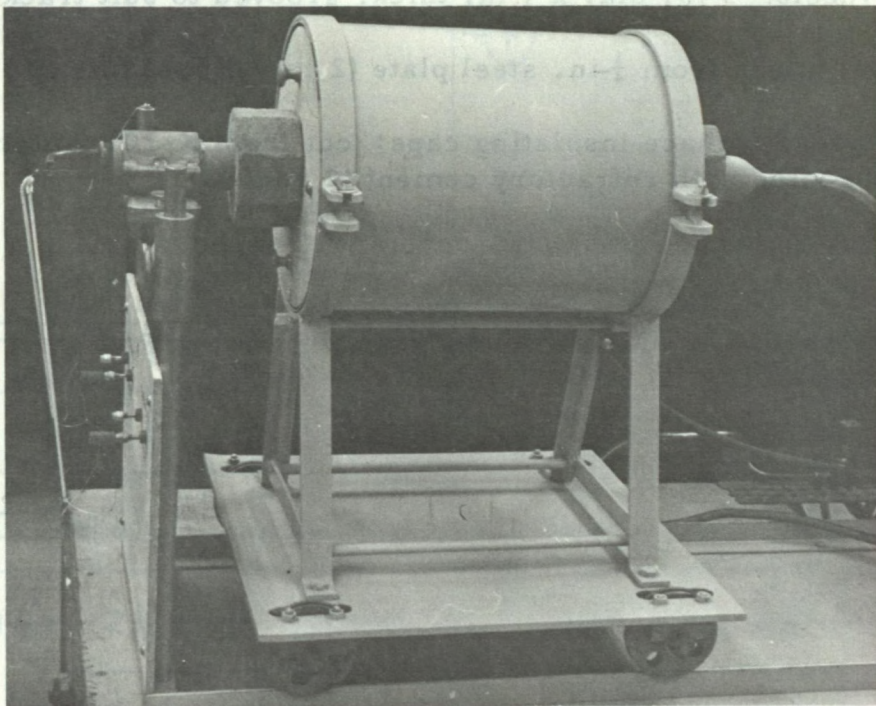


Figure 2b. Set-up for flowing-gas-atmosphere run.

Parts list for Figures 2c, 2d and 2e

1. Supporting posts: 5/8-in.-dia. brass rod (2 req'd.).
2. Base for supporting posts: 1-in. x 1-in. brass stock (1 req'd.).
3. Transite base for furnace tracks: 36 in. x 15 in. x 1/2 in. (1 req'd.).
4. Furnace tracks: 1-in. x 1-in. x 1/8-in. steel angles, 36 in. long (2 req'd.).
5. Furnace platform: 15 1/2-in. x 15-in. x 1/4-in. steel plate (1 req'd.).
6. Saddle for furnace shell: 1-in. x 3/16-in. strap steel (2 req'd.).
7. Saddle supporting feet: 1-in. x 1-in. x 3/16-in. steel 'T' stock (4 req'd.).
8. Braces for feet: 3/16-in. x 3/4-in. strap steel (2 req'd.).
9. Spacer rods: 3/8-in.-dia. steel rod, 11 1/4 in. long (2 req'd.).
10. Tie bolt: 3/8-in.-dia. steel rod, 13 in. long (1 req'd.).
11. Upper clamps for furnace shell: 1-in. x 3/16-in. strap steel (2 req'd.).
12. Furnace wheels: 3-in. dia. x 1/2 in. thick, grooved to suit track (4 req'd.).
13. Back stops: made from 1/4-in. steel plate (2 req'd.).
14. Front and rear furnace insulating caps: cut from K-20 insulating fire-brick and coated with refractory cement (2 req'd.).

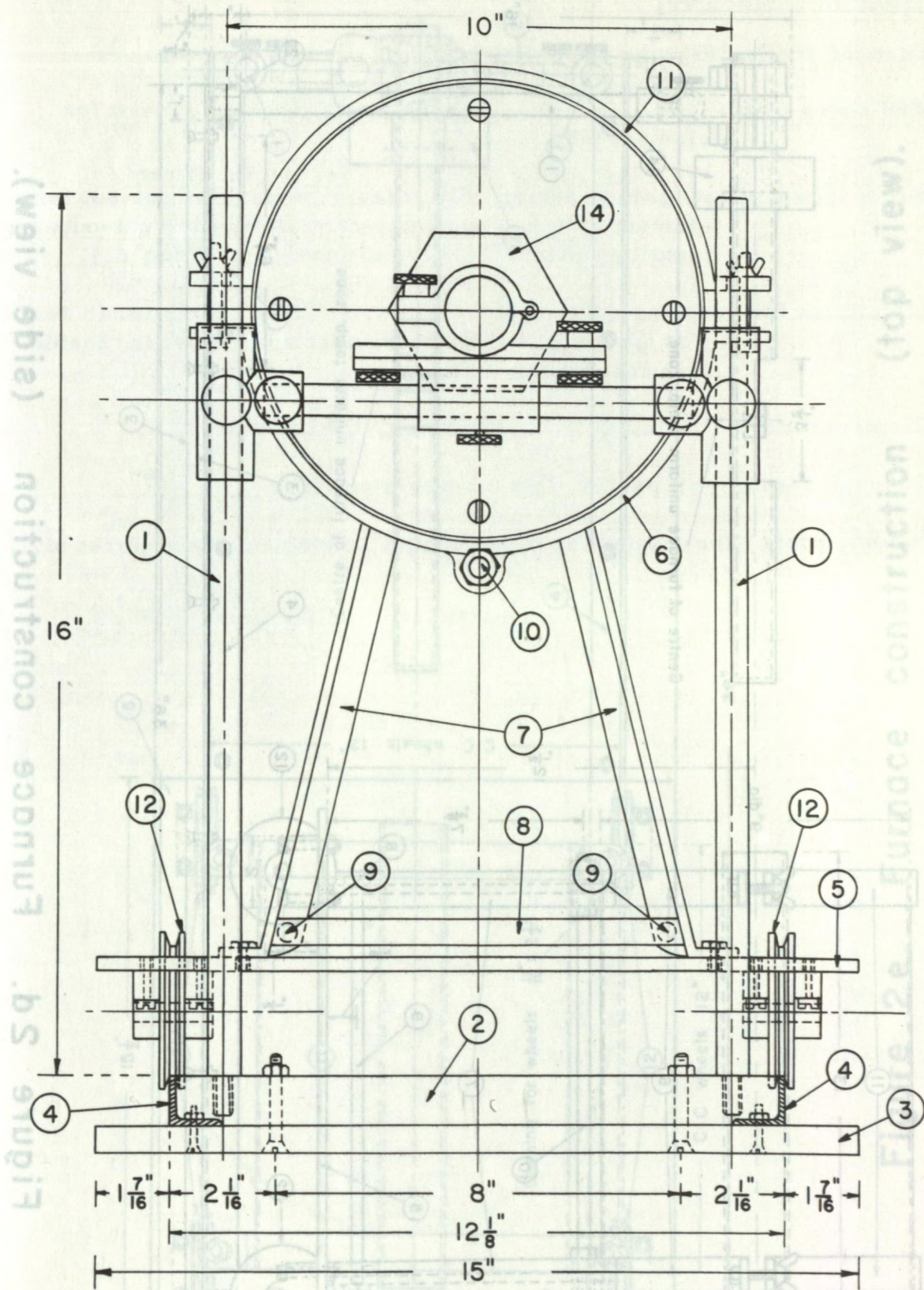


Figure 2c. Furnace construction (front view).



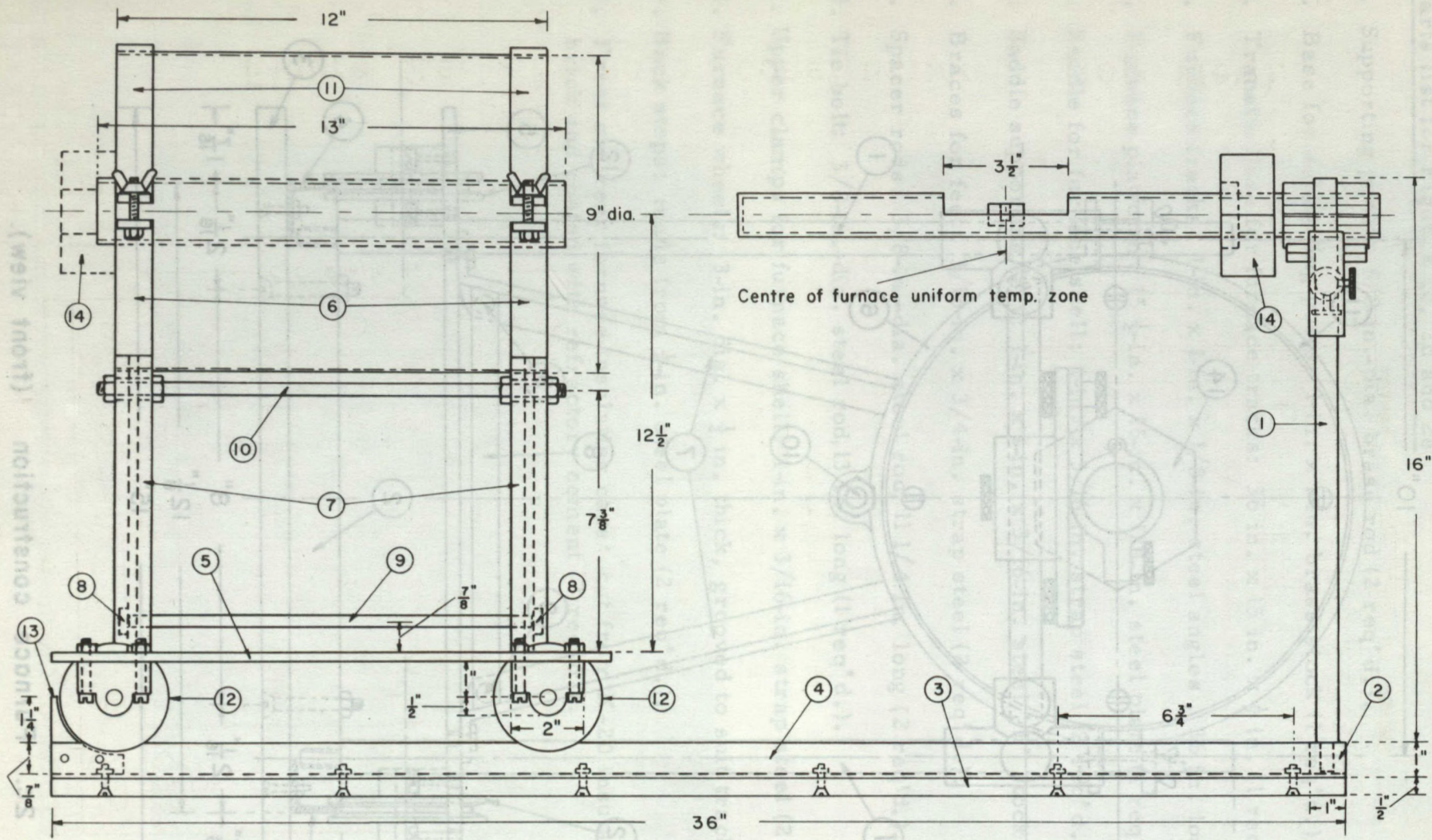


Figure 2d. Furnace construction (side view).

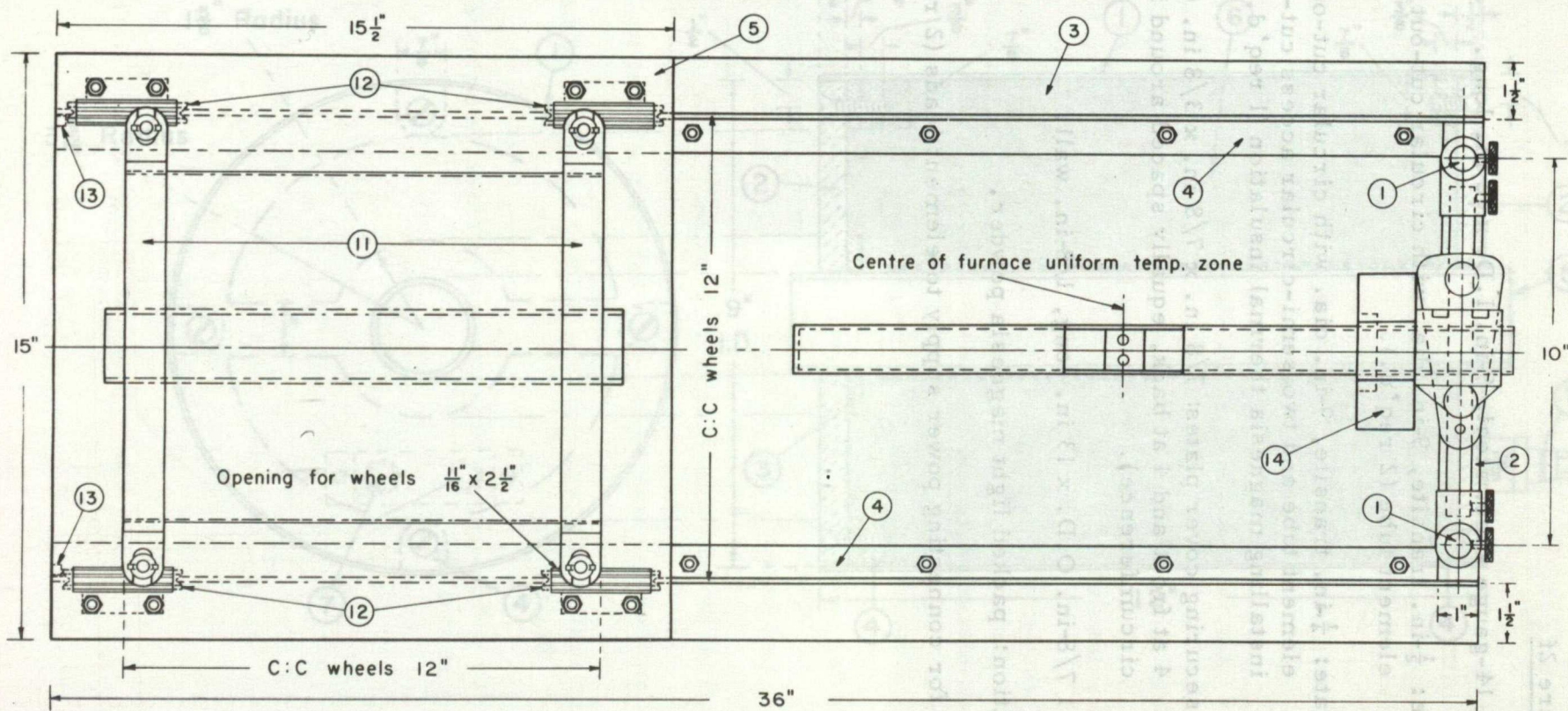


Figure 2e. Furnace construction (top view).

Parts list for Figure 2f

1. Furnace shell: 14-gauge sheet steel, 9-in. I.D. x 12 in. long.
2. End cover plate:  $\frac{1}{2}$ -in. transite, 9-in. dia. with circular cut-out for element tube (2 req'd.).
3. Front inside plate:  $\frac{1}{4}$ -in. transite, 9-in. dia. with circular cut-out for element tube and two semi-circular access cut-outs for installing magnesia thermal insulation (1 req'd.).
4. Metal lugs for securing cover plates:  $\frac{7}{8}$  in. x  $\frac{7}{8}$  in. x  $\frac{3}{8}$  in. (8 req'd., 4 at front and 4 at back, equally spaced around inside circumference).
5. Element tube: 1  $\frac{7}{8}$ -in. O.D. x 13 in. long,  $\frac{1}{8}$ -in. wall.
6. Thermal insulation: packed light magnesia powder.
7. Binding posts for connecting power supply to element leads (2 req'd.).

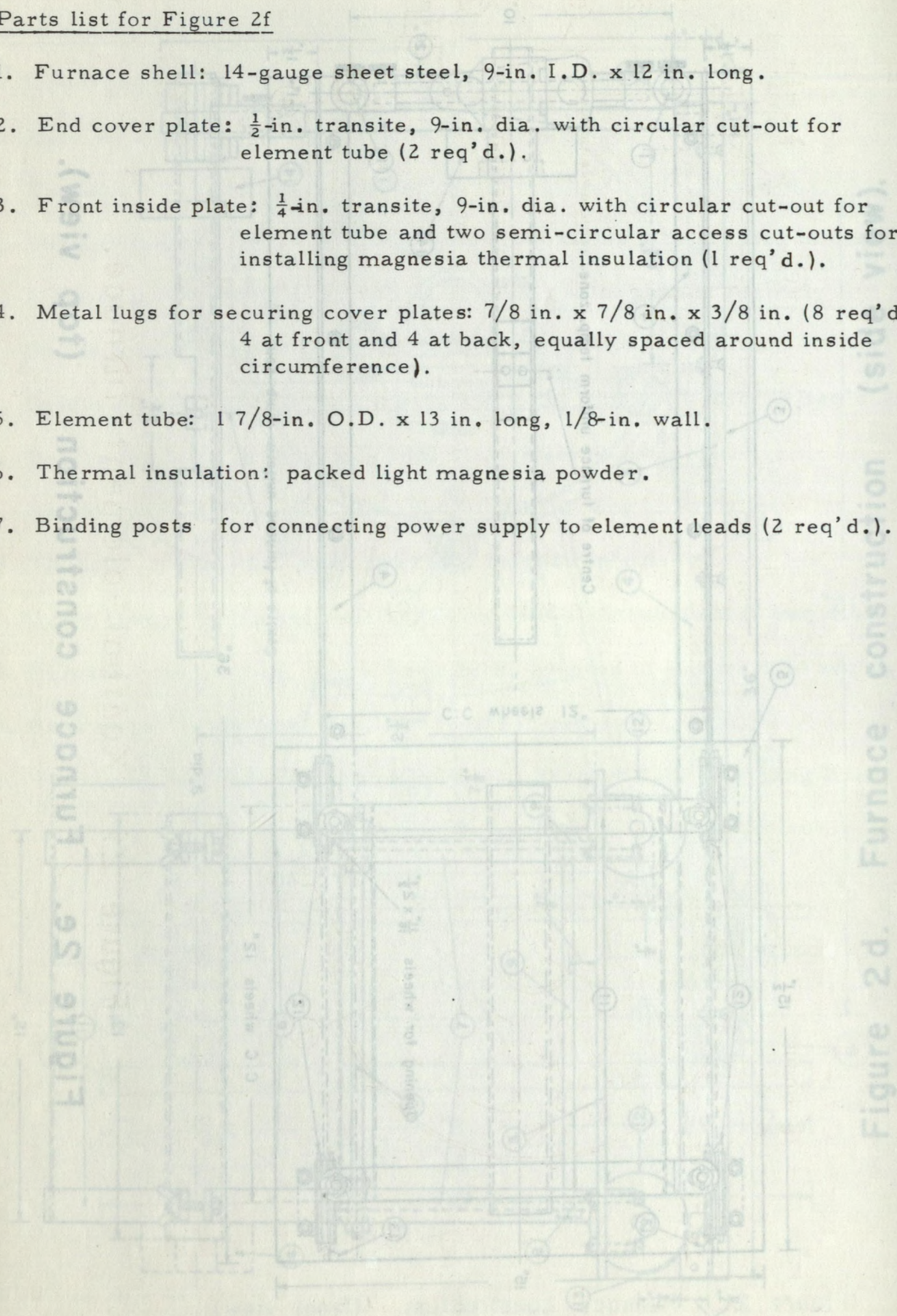


Figure 2d. Furnace construction (side view).



Parts list for Figure 2g

1. Furnace shell: 14-gauge sheet steel, 9-in. I.D. x  $12 \frac{1}{2}$  in. long.
2. End cover plate:  $\frac{1}{2}$ -in. transite, 9-in. dia. with circular cut-out for element tube (2 req'd.).
3. Front inside plate:  $\frac{1}{4}$ -in. transite, 9-in. dia., with circular cut-out for refractory tube containing bubble alumina thermal insulation, and also two semi-circular access cut-outs for installing magnesia thermal insulation (1 req'd.).
4. Rear inside plate:  $\frac{1}{4}$ -in. transite, 9-in. dia., with circular cut-out for refractory tube containing bubble alumina thermal insulation (1 req'd.).
5. Metal lugs for securing cover plates:  $\frac{7}{8}$ -in. x  $\frac{7}{8}$  in. x  $\frac{3}{8}$  in. (8 req'd., 4 at front and 4 at back, equally spaced around inside circumference).
6. Element tube:  $1 \frac{7}{8}$ -in. O.D. x  $13 \frac{1}{2}$  in. long,  $\frac{1}{8}$ -in. wall.
7. Refractory tube for holding high-temperature thermal insulation:  $3 \frac{3}{4}$ -in. O.D. x  $11 \frac{3}{8}$  in. long (with  $\frac{1}{16}$ -in. clearance at either end to allow for expansion).
8. Thermal insulation: packed light magnesia powder.
9. High-temperature thermal insulation: -10 mesh bubble alumina.
10. Alundum cement seal at both ends of tube holding bubble alumina thermal insulation.
11. Binding posts for connecting power supply to element lead wires (2 req'd.).

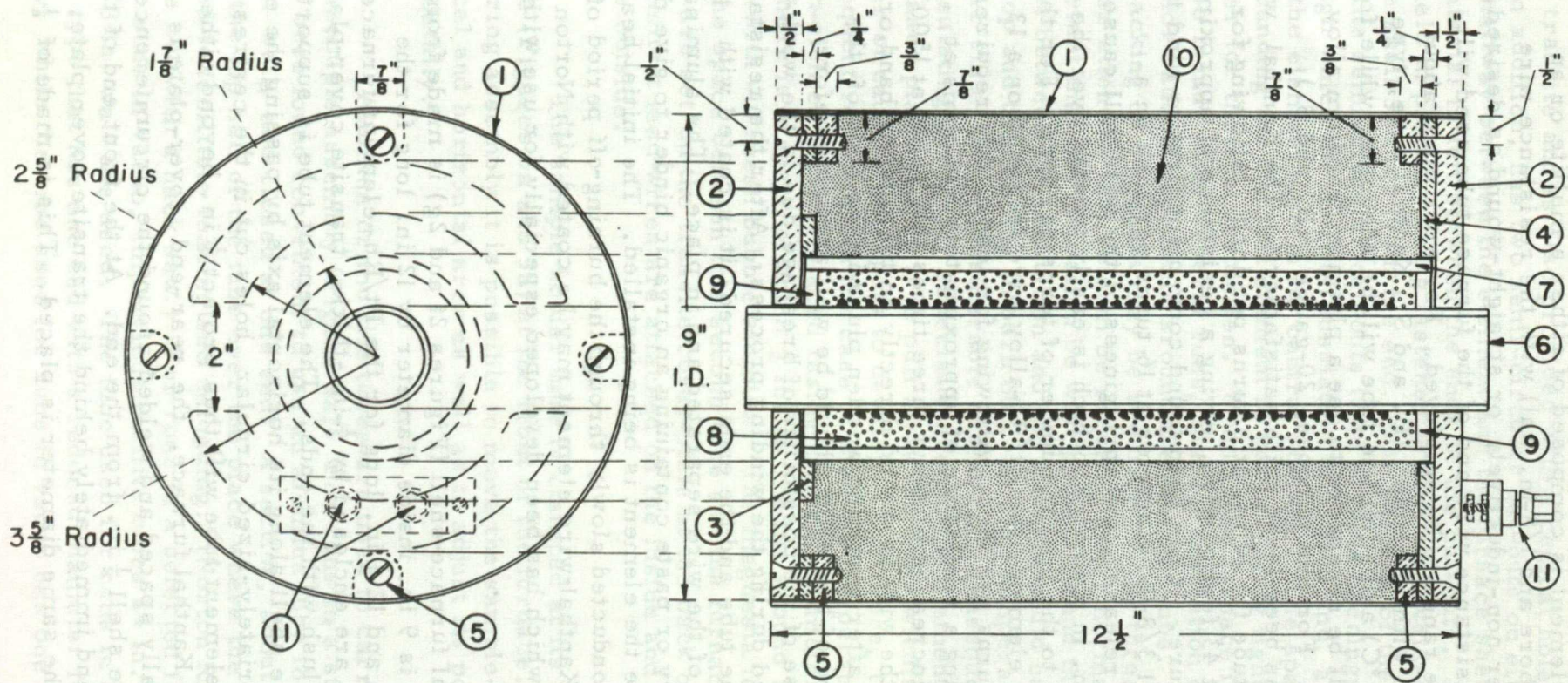


Figure 2g. Platinum / rhodium - element furnace.

The furnace element is composed of either a mullite or an alumina tube of 1 5/8-in. bore and 1/8-in. wall with the resistance wire wound on the outside, either non-inductively or straight-wound as desired. The composition of the resistance wire and of the furnace tube used will depend on the temperature range to be employed. For work up to about 1200°C, an element wound with 15-gauge (B. and S.) Kanthal wire, type A (1300°C) or type A-1 (1350°C) and a mullite tube will be adequate, while, for studies up to 1600°C, it will be necessary to use a platinum/rhodium alloy wire and an alumina tube. For this purpose, 20-gauge (B. and S.) 60/40 Pt/Rh alloy wire has been found quite satisfactory. The Kanthal wire is wound on a 13-in.-long tube for 10 in. at 8 turns per inch. Allowing for leads, this requires about 43 feet of wire, giving a resistance of approximately 11 ohms at room temperature. It has been found convenient first to wind the wire on a rod or arbor of 1 3/8-in. diameter at 16 turns per inch on a machinist's lathe. When released, the springiness of the wire will cause it to expand to a coil 1 3/4 in. in diameter, which is easily twisted over the element tube and adjusted to the proper number of turns per inch. For the high-temperature furnace element, the Pt/Rh-alloy wire is wound on a 13 1/2-in.-long tube for 10 in. at 10 turns per inch. Allowing for leads, this requires about 53 feet of wire, giving a resistance of approximately 5.5 ohms at room temperature, which increases to about three times this value at 1500° to 1600°C. In this case, the wire is wound directly on the tube by hand, or by using a machinist's lathe after inserting wooden plugs in the ends of the tube for the centres. Wire of this alloy should be well annealed before winding on the tube, because of the possibility of breakage due to the work-hardening that is developed during the winding process. After the resistance wire has been wound on the tube and the ends secured, it is coated with alumina to keep the turns of the wire separated and in place. The alumina is applied as a thick slurry or paste containing an organic binder to give dry strength for handling while the element is being installed. The initial heating of the furnace should be conducted slowly through the burning-off period of the organic binder. The Kanthal-wire element may be coated with Norton Company RA1162 cement, which has been developed especially for use with Kanthal resistors.

The cylindrical furnace-shell (Figures 2f and 2g) is made from 14-gauge sheet steel and is 9 in. inside diameter by 12 in. long for the Kanthal-element furnace and 12 1/2 in. long for the Pt/Rh-element furnace. The open ends of the shell are enclosed by 1/2-in.-thick transite cover-plates which fit inside the shell flush with the ends. The element tube is supported in the centre of the furnace shell along its horizontal axis by passing the ends of the tube through appropriately-sized circular holes cut in the centres of the cover plates. The element tube will thus project 1/2 in. beyond either end of the furnace. In the Kanthal furnace, the rear-end cover-plate is fastened to four lugs, equally spaced and welded around the circumference on the inside surface of the shell 1/2 in. from the end. At the front end of the furnace, inside the shell and immediately behind the transite cover plate, a second plate or disc of the same diameter is placed. This is made of 1/4-in.-

thick transite and is also provided with a central hole for the element tube and, in addition, has two semi-circular cut-outs on either side of the central hole halfway between the element and the furnace shell. About 1 in. to 2 in. of material is left between the ends of the cut-outs. Both transite plates are held in place by being fastened to four lugs welded around the inside of the shell  $\frac{3}{4}$  in. from the end. The purpose of the inside transite plate with the semi-circular cut-outs is to provide openings into the furnace shell through which the thermal insulation is packed and, at the same time, to hold the element tube in its central position. The space in the shell surrounding the Kanthal element is packed fairly tightly with light magnesia powder for thermal insulation. When a new furnace is put into operation, it will be found, after several runs, that the insulation can be packed down and more added, especially around the element tube. This further adding and packing of magnesia may be required two or three times, after which further attention will seldom be required under normal operation. It is important that the insulation be well packed around the element, for an air pocket between the insulation and the element could cause a hot-spot to develop and the winding to burn out. At high temperatures, light magnesia powder sinters to a considerable extent and, consequently, loses some of its insulating property, especially around the element, where the shrinkage that takes place causes it to pull away from the winding, with the attendant danger of causing hot-spots to develop. Therefore, to avoid the necessity of frequent repacking in the case of the high-temperature furnace, the Pt/Rh-element tube is placed inside a larger-diameter refractory tube, so that there is a space of about  $\frac{1}{2}$  in. to  $\frac{3}{4}$  in. around the winding which is filled with -10 mesh bubble alumina. The magnesia insulation is then packed into the space between this second tube and the furnace shell. Two binding posts are set on the transite cover-plate at the back of the furnace, to which the element lead-wires are attached on the inside and the power-supply leads on the outside.

The sample-holder tube is clamped at its open end in a centering device (Figures 3a and 3b) at the front of the furnace. By means of the centering assembly it is possible to move the sample-holder tube through vertical and horizontal arcs as well as to adjust its position vertically and horizontally.

Alumina or mullite tubes are used to carry the sample holder and the thermocouple assembly (Figure 4a). For runs in a static-air atmosphere, it has been found convenient to use an alumina tube 18 in. long, 1-in. bore,  $\frac{1}{8}$ -in. wall, and closed at one end. A section, about  $3\frac{1}{2}$  in. long, is cut from the top half of the tube over the place where the sample holder will be located to facilitate loading and unloading. (Norton RA 98 alumina tubes can be cut with a hack saw.) For runs in a selected flowing-gas atmosphere or for runs in vacuo, impervious mullite tubes 24 in. long with  $1\frac{1}{4}$ -in. bore and  $\frac{1}{8}$ -in. wall are used. The tube used for runs in a flowing-gas atmosphere is the type that has one end with a reduced diameter for connecting to the gas supply, while the tube used for runs in vacuo has one end fully closed.



For controlled-atmosphere or vacuum runs, the sample holder and the thermocouple assembly (Figure 4b), after being prepared for a run, are muzzle-loaded into the mullite sample-holder tube (Figure 4d) through the open end by means of a carrier (Figure 4c), which is left in place during the run. The open end of the mullite tube is closed by a rubber stopper through which pass a four-hole insulating sheath carrying the thermocouples, a sample-holder ground wire, and a short copper tube for connecting to the vacuum pump or for conducting out the gas used during a controlled-atmosphere run. Picein cement is used to seal the holes where the thermocouple and ground wires emerge from the insulating sheath.

To prevent air currents from circulating through the element tube and, thereby, to assist in minimizing the temperature gradient as well as in reducing the heat loss, the ends of the element tube at the front and back of the furnace are capped during a run with suitable covers cut from insulating firebrick. They are made about 3 1/2 in. in diameter and 1 1/2 in. thick, with a hole through the centre of sufficient diameter to give a sliding fit over the sample-holder tube. This hole, at the side of the cover which faces against the transite cover-plate in the end of the furnace, is increased in diameter to a sufficient depth to fit over the end of the element tube which projects 1/2 in. beyond the furnace.

This type of furnace provides a uniform temperature zone, approximately 1 1/2 in. long, in the middle section of the element tube and, when the furnace is in position for a run, the sample holder should be in the centre of this zone.

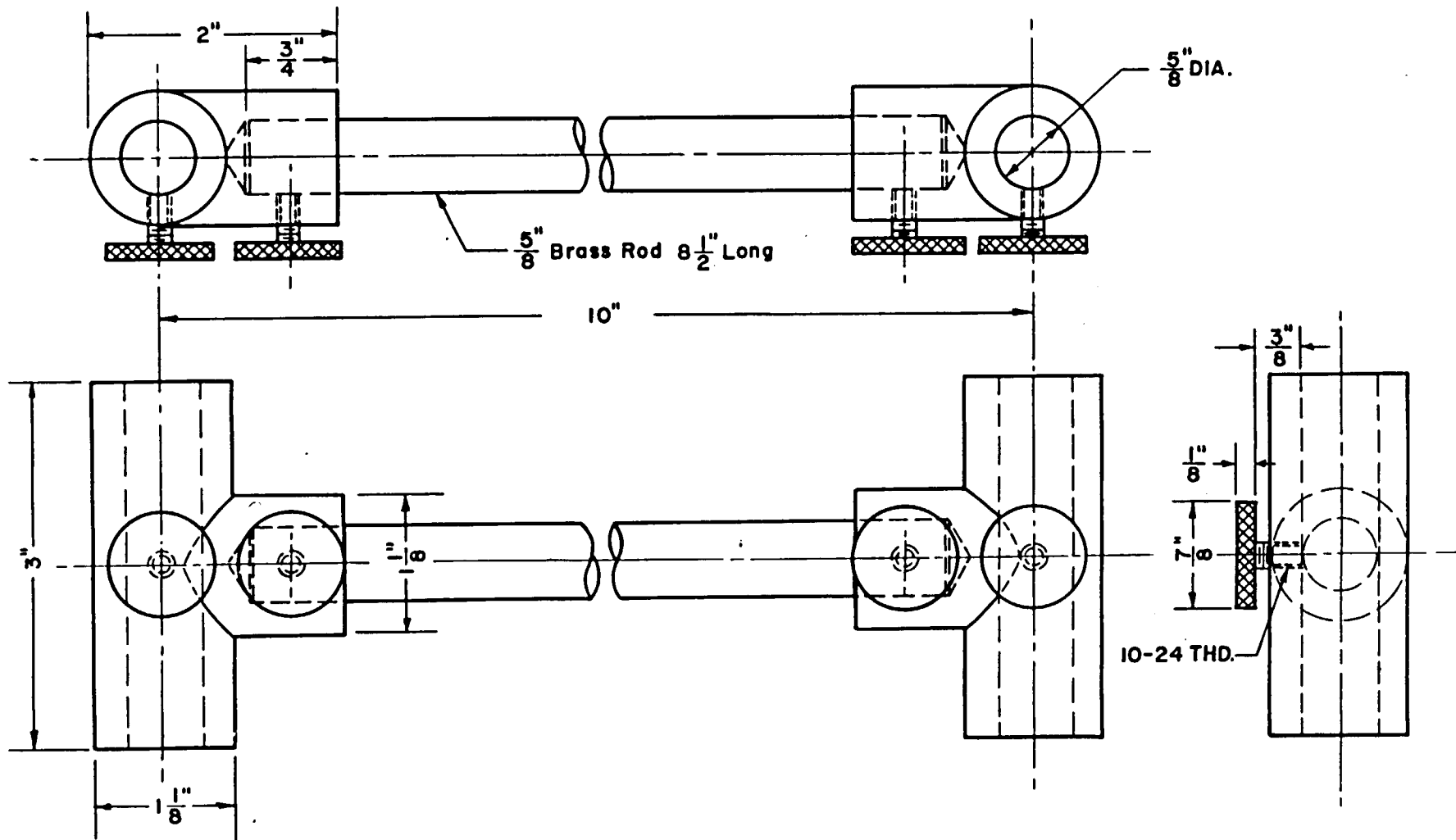


Figure 3a. Centering assembly (part one).

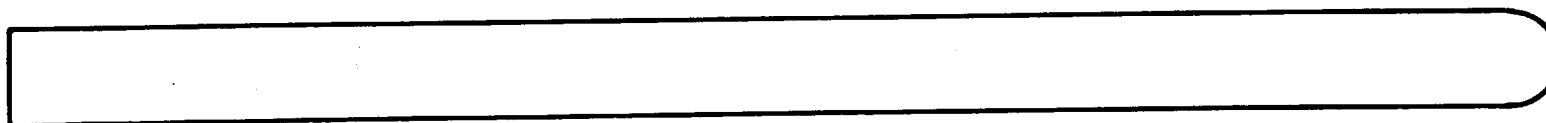




Alumina, Norton RA 98, one end closed, showing cut-out.



Mullite, one end reduced



Mullite, one end closed.

Figure 4a. Sample-holder tubes.

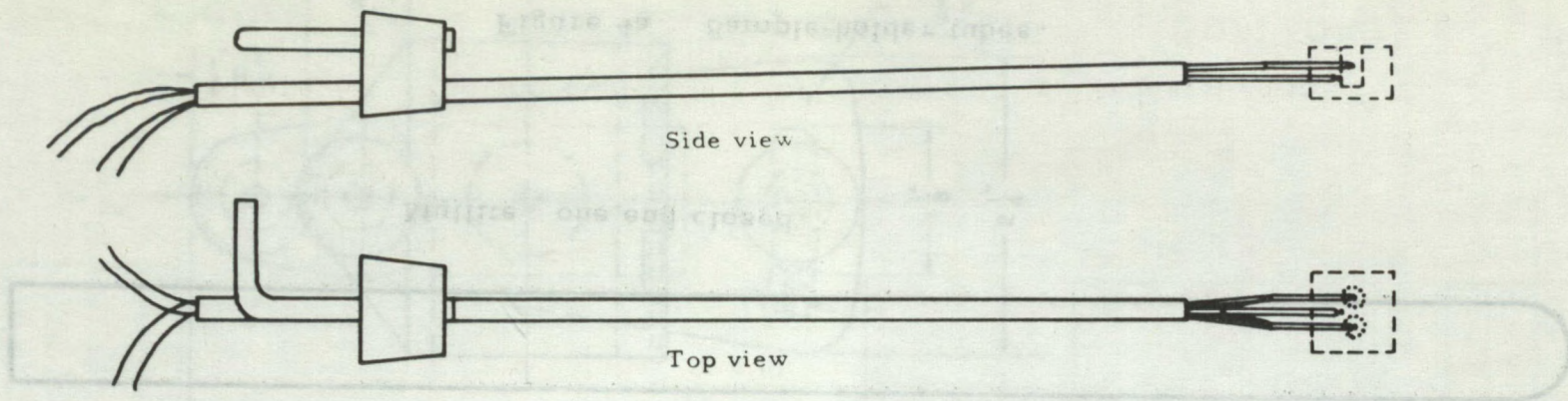


Figure 4b. Thermocouple arrangement for flowing-gas or vacuum runs.

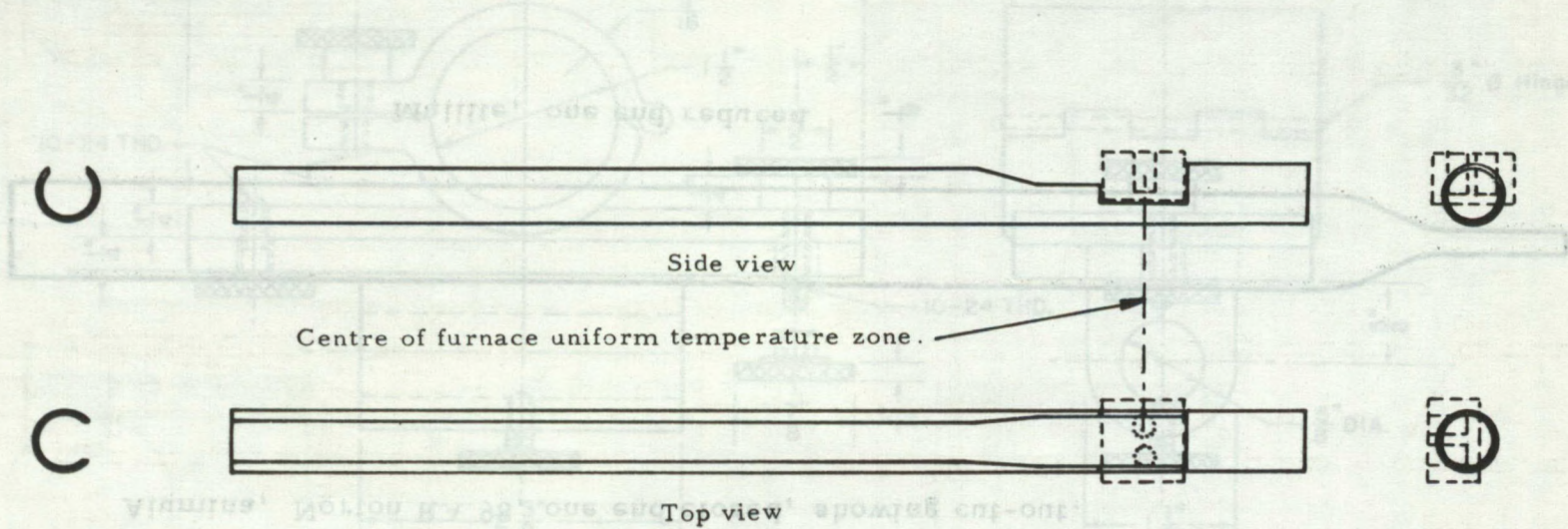


Figure 4c. Carrier for sample holder and thermocouple assembly.  
(Refractory tube, 3/4-in. O.D., cut as indicated.)

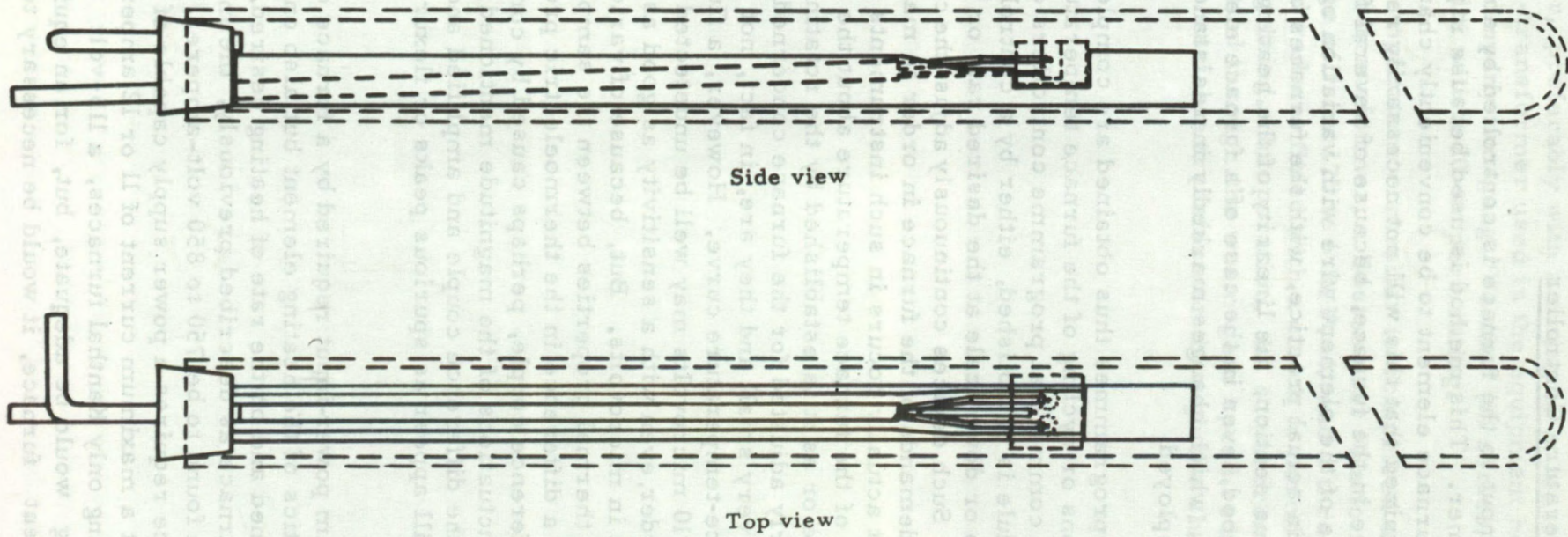


Figure 4d. Thermocouple and sample-holder assembly installed in sample-holder tube.

### C. The Furnace-Temperature Controller

The power input to the furnace is controlled by a motor-driven variable auto-transformer. This method is used because it permits the voltage applied to the furnace element to be conveniently changed at a linear rate. While it is recognized that this will not necessarily result in a linear rate of temperature rise in the furnace, because of several factors, including the change in resistance of the element wire with variation of temperature, it has been found that, in actual practice, with the furnaces constructed as described in the previous section, the linearity of the heating rates achieved has been surprisingly good, even in the case of a furnace element wound with 60/40 Pt/Rh wire, which changes markedly in resistance over the temperature ranges employed.

The heating programmes thus obtained are completely devoid of short-term oscillations or cycling of the furnace temperature. Such cycling may occur with commercial programme controllers of the type in which the heating schedule is established, either by a control point that is automatically moved up or down scale at the desired rate or by a cam cut to the required schedule. Such devices continuously adjust the current supply in response to the power demands of the furnace in order to maintain the heating schedule. What actually occurs in such instruments is, in effect, a cycling or oscillation of the furnace temperature about the control point as it moves along the scale or as it is established by the rotating cam. When the controller is properly adjusted for the furnace concerned, the amplitude of these oscillations is very small and they are, in fact, not normally noticeable on the furnace-temperature curve. However, a fluctuation with an amplitude of only  $\pm 5$  to 10 microvolts may well be undetected and unregistered by a temperature recorder, even with a sensitivity as good as  $\pm 0.1\%$  of the range of the instrument in microvolts. But, because of various factors, including a disparity in thermal properties between the sample and the reference material or a difference in the thermoelectric properties of the two junctions of the difference couple, perhaps caused by contamination, furnace-temperature fluctuations of the magnitude mentioned above may easily be picked up by the difference couple and amplified and, especially at high sensitivities, will appear as spurious peaks or flexures on the differential trace.

The maximum power-input required by a furnace depends not only on the characteristics of the heating element but also on the maximum temperature to be attained and on the rate of heating desired. In the case of a Kanthal-element furnace as described previously, the maximum power-input required has been found to be 750 to 850 volt-amperes, while the Pt/Rh-element furnace requires a power supply capable of delivering close to 2000 volt-amperes at a maximum current of 11 or 12 amperes. Hence, in a DTA equipment using only Kanthal furnaces, a 115-volt auto-transformer with a 10-ampere rating would be adequate, but, for an equipment that includes a Pt/Rh-element furnace, it would be necessary to use a 230-volt

auto-transformer, preferably with a rating of at least 12 amperes. For this reason, the auto-transformer used in the equipment herein described is a General Radio Company two-gang "Variac" (in series), each unit capable of delivering 115 volts with a 20-ampere rating.

The temperature controller is comprised of three units, which are: the "Variac" auto-transformer; a Boston gear "Ratiotrol" variable-speed drive with a range of from 175 to 6 R. P. M.; and a three-stage, 24000-to-1, worm-gear speed reducer fitted with a clutch to permit disengaging the "Variac" for re-setting. In operation, the output from the variable-speed drive is transmitted through the worm-gear speed reducer and applied to the rotor shaft of the variable transformer through the clutch. (Figures 5a and 5b)



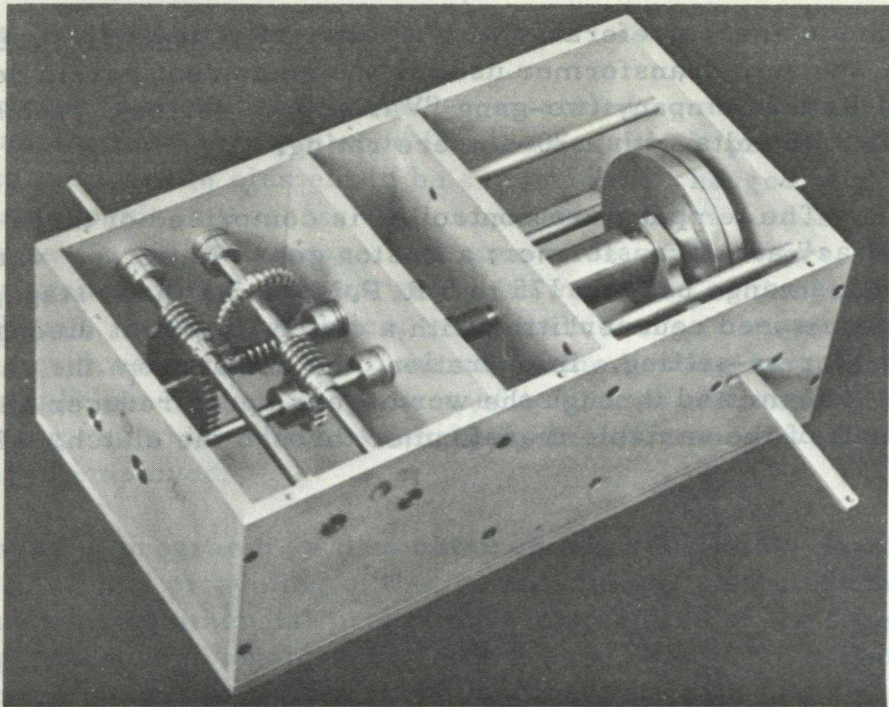


Figure 5a. View of worm-gear speed reducer and clutch.

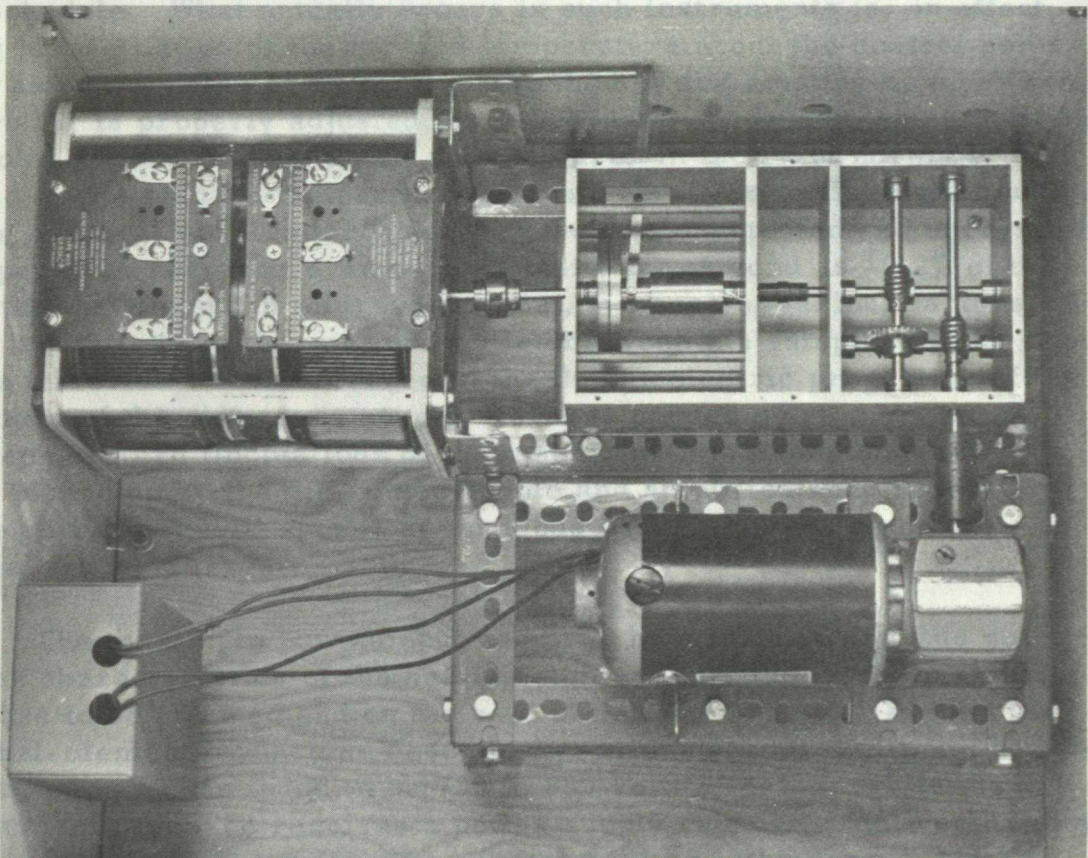


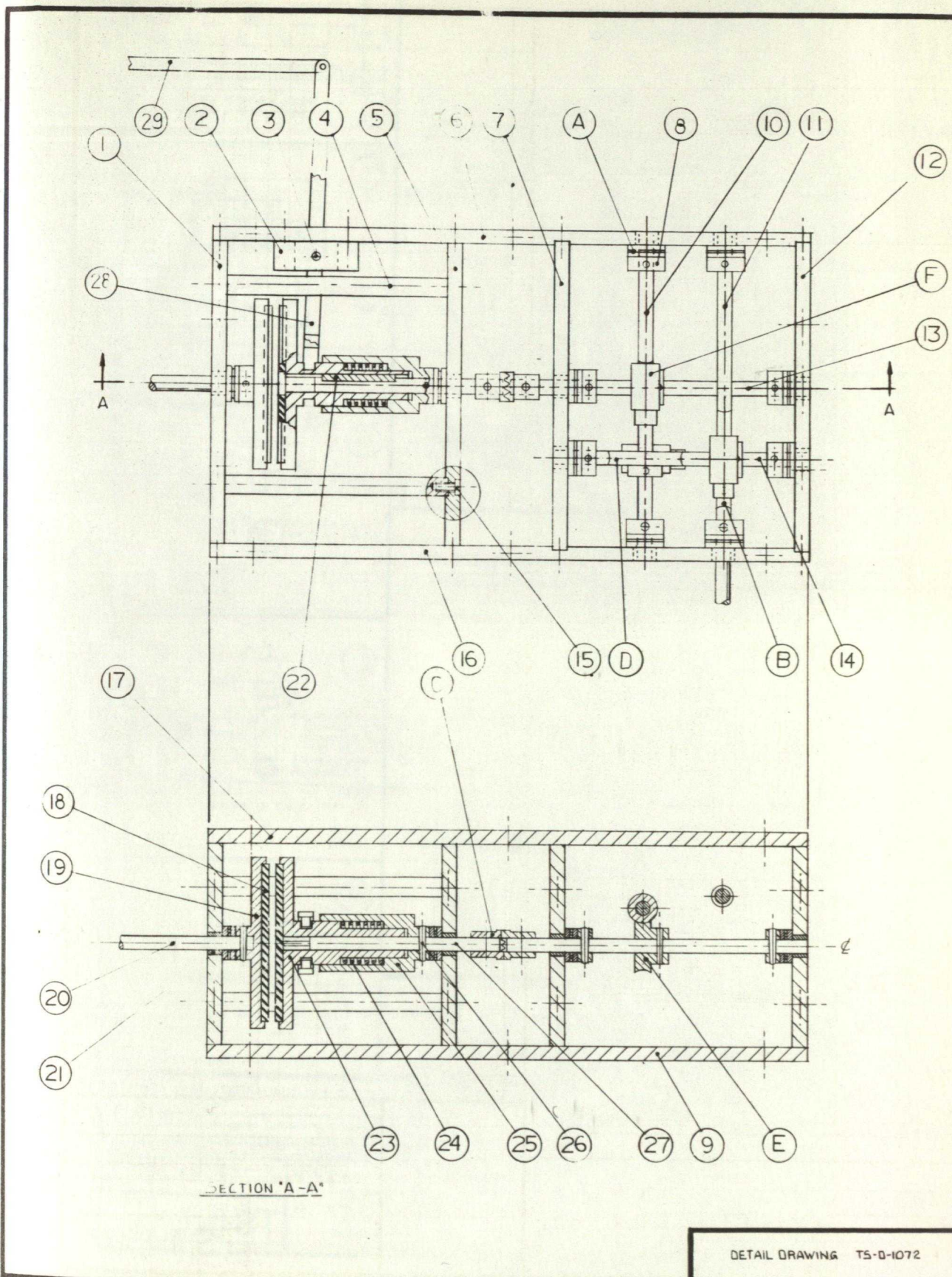
Figure 5b. View of temperature controller, showing arrangement of variable-speed drive, worm-gear speed reducer with clutch, and "Variac" auto-transformer.

With this arrangement, rates of voltage increase range from more than 2 volts per minute to about 1 volt in 15 minutes if the auto-transformer is connected to give an output of 230 volts, or to about 1 volt in 13 minutes if the connection is such as to deliver 270 volts. These rates of voltage increase result in furnace heating rates of from above 25 deg C per minute to below 3 deg C per minute, respectively. The direction of rotation of the variable-speed drive is reversible, so that corresponding rates of voltage decrease are possible. If a 115-volt variable transformer is used, then the design of the worm-gear speed reducer will have to be modified to give a reduction of 12000 to 1 instead of 24000 to 1, so that the same rates of voltage increase and, hence, the same heating rates will be obtainable. The worm-gear speed reducer and clutch assembly were designed in the laboratory and constructed in the machine shop of the Technical Services Division, Mines Branch. As an alternative to constructing a worm-gear speed reducer as above, it is quite probable that a Boston "Ratiotrol" variable-speed drive and two Boston Reductors could be chosen with the proper ranges and connected in series to give the same rates of voltage change. However, the clutch section of the assembly, or some other means of disengaging the auto-transformer for re-setting, would still be required.

Figures 5c and 5d are quarter-size reproductions of the working drawings of the worm-gear speed reducer and clutch assembly. If required, full-scale working drawings may be obtained by sending a request to the author of this report.

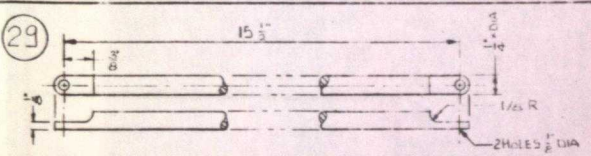
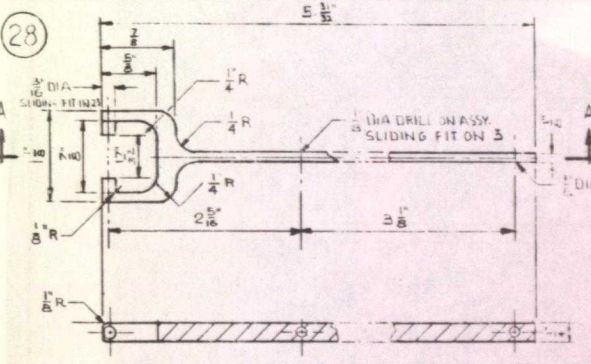
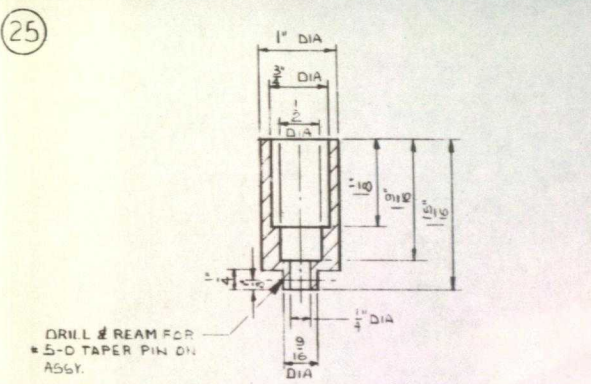
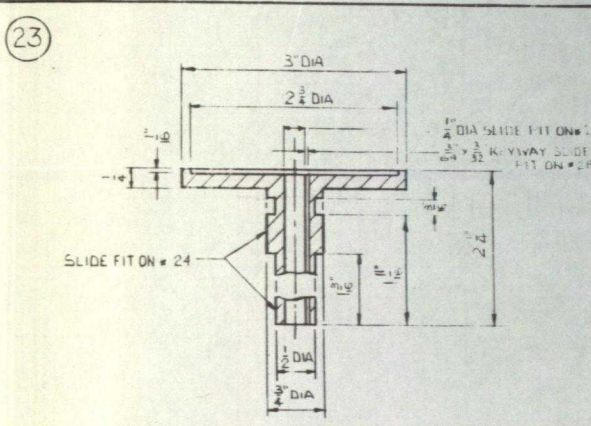
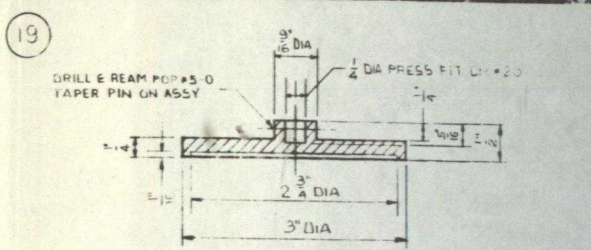


Figure 5c. Worm drive and clutch (part one)



SECTION "A-A"

DETAIL DRAWING TS-D-1072



ITEM NO	DESCRIPTION	MAT	QTY	REMARKS
1	WORM	COMM 3	BOSTON CAT # 1114	
E	WORM GEAR	COMM 1	BOSTON CAT # 1034	
D	WORM GEAR	COMM 1	BOSTON CAT # 1034	
C	COUPLING	COMM 1	BOSTON CAT # 1035	
B	WORM GEAR	COMM 1	BOSTON CAT # 1035	
A	THRUST RACE	COMM 10	BOSTON CAT # 1036	
29	CONNECT NG ROD	ST 1		
28	CLUTCH ROD	ST 1		
27	SHAFT	DR 1		
26	TAPER PIN	ST 10	NO. 5-0	
25	SHAFT	DR 1		
24	WORM	COMM 1	BOSTON CAT # 1034	
23	CLUTCH DISC	ST 1		
22	KEY	ST 1	1/4 x 3/8 x 1 1/2	
21	BLUSHING	ALITE 13		
20	SHAFT	DR 1		
19	CLUTCH DISC	ST 1		
18	CLUTCH FACE	BRASS	2 1/2 DIA x 1/2	
17	TOP	ALITE 1	1/4" THICK PLATE	
16	FRONT WALL	AL 655-T8	1/4" THICK PLATE	
15	SOL HD CAP SCREW	ST 4	5-40 UNC x 3/8 LENS	
14	SHAFT	DR 1		
13	SHAFT	DR 1		
12	WALL (SHAF BOX)	AL 655-T8	1/4" THICK PLATE	
11	SHAFT	DR 1		
10	SHAFT	DR 1		
9	BASE	AL 655-T8	1/4" THICK PLATE	
8	COLLAR	ST 8		
7	WALL (SHAF BOX)	AL 655-T8	1/4" THICK PLATE	
6	BACK WALL	AL 655-T8	1/4" THICK PLATE	
5	WALL (CLUTCH BOX)	AL 655-T8	1/4" THICK PLATE	
4	SPACER ROD	ST 4		
3	PIVOT	ST 1	3/8 ROUND END	
2	PIVOT BRG	ST 1		
1	WALL (CLUTCH BOX)	AL 655-T8	1/4" THICK PLATE	

REV	NO	DESCRIPTION	MAT	QTY	REMARKS
		REVISIONS			
		WORM DRIVE AND CLUTCH FOR VARIAL SUPPLY			
		CLUTCH FURNACE - ASSY & DETAIL			
		DEPARTMENT OF ENERGY, MINING AND RESEARCH			
		MINERAL SCIENCES			
		UNLESS OTHERWISE NOTED			
		TOLERANCES: DIMS			
		TOL ON FRAC DIMS			
		TOL ON ANGLES			
		SURFACE ROUGHNESS			

TS-D-1071

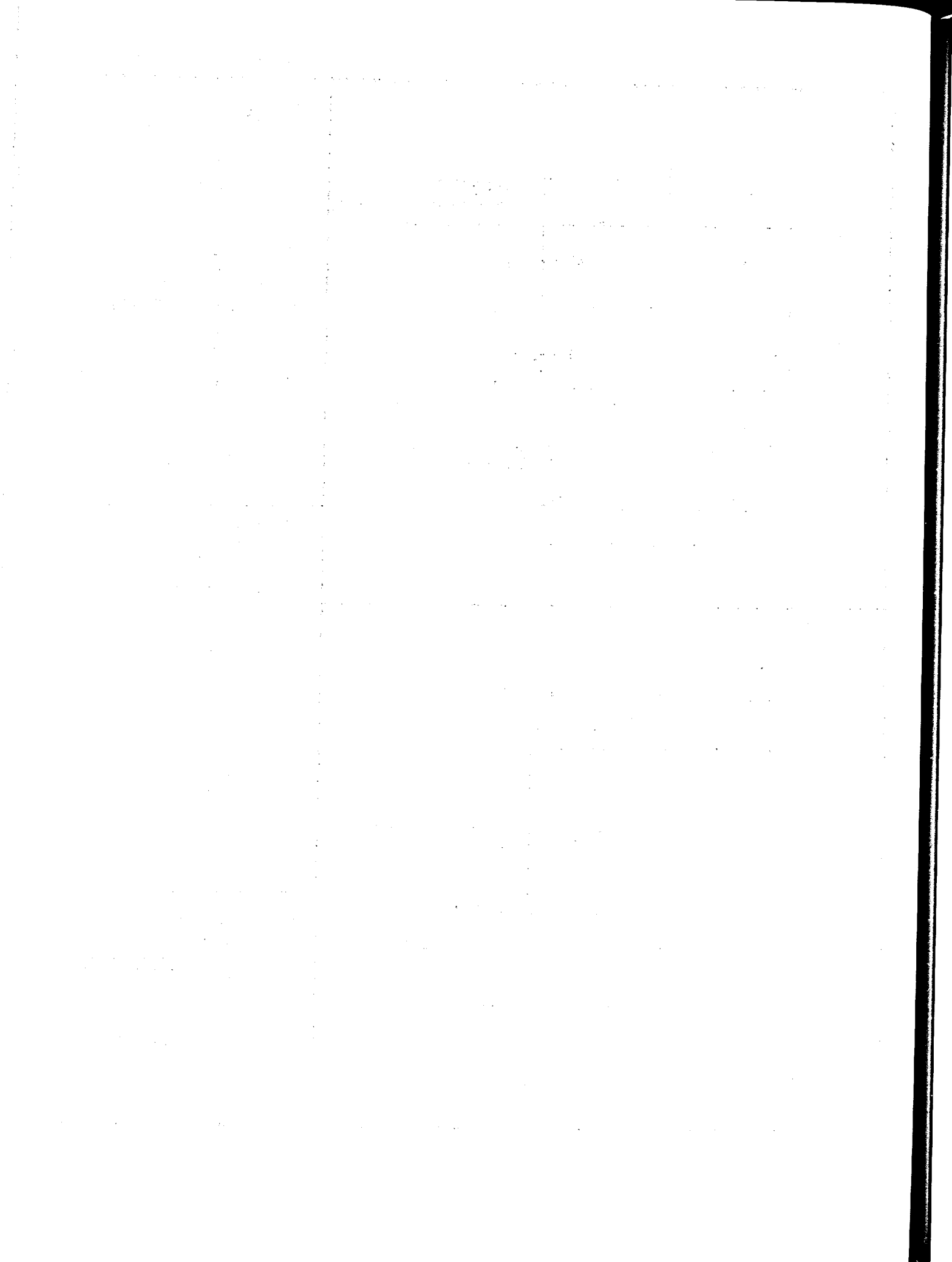
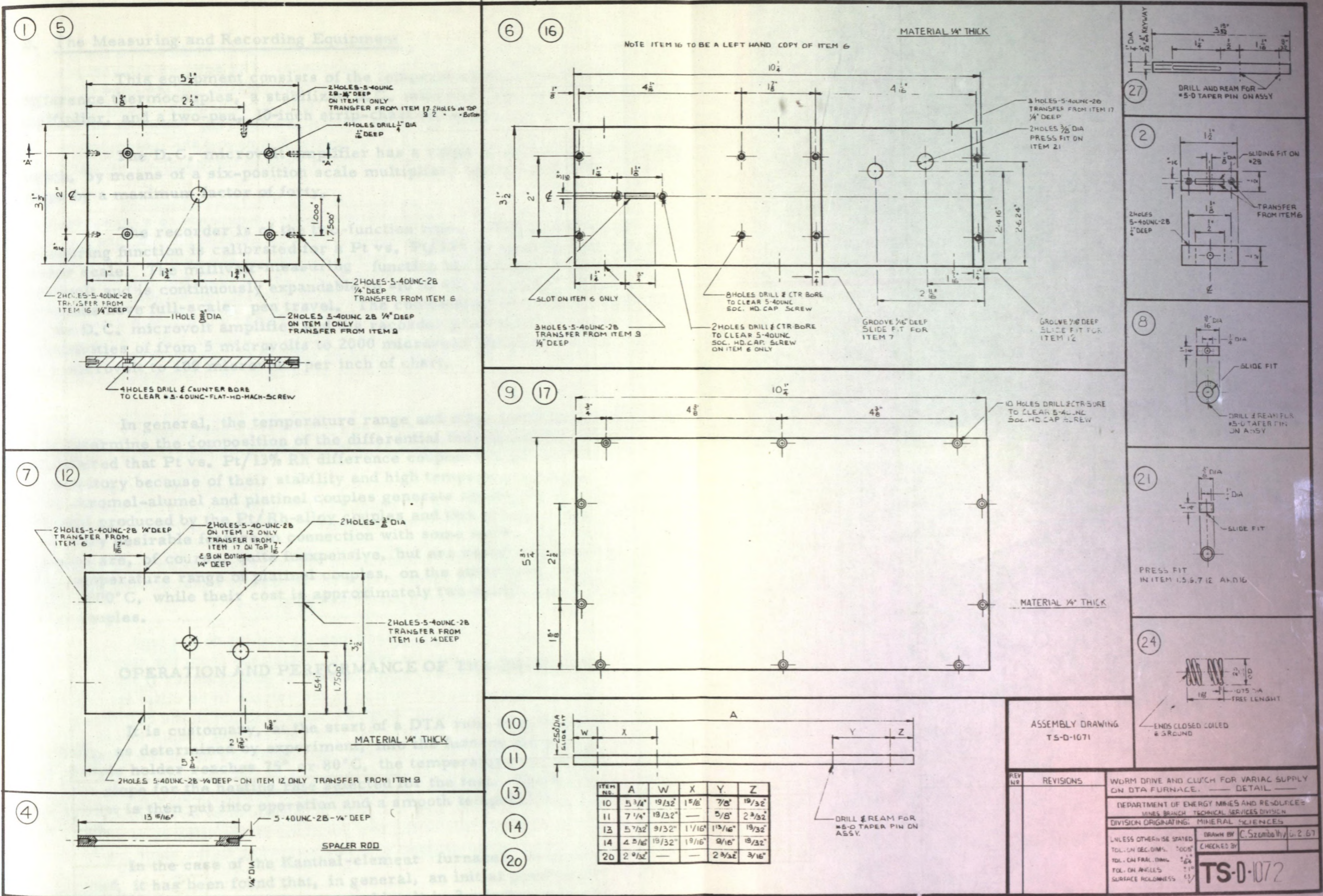


Figure 5d. Worm drive and clutch (part two)





#### D. The Measuring and Recording Equipment

This equipment consists of the temperature-measuring and difference thermocouples, a stabilized D.C. microvolt amplifier with scale multiplier, and a two-pen, 10-inch strip-chart recorder.

The D.C. microvolt amplifier has a range of -25 to +25 microvolts which, by means of a six-position scale multiplier, can be expanded in six steps by a maximum factor of forty.

The recorder is of the two-function type. The temperature-measuring function is calibrated for a Pt vs. Pt/13% Rh thermocouple on a linear scale. The millivolt-measuring function has a range from -1 to +1 millivolt and is continuously expandable to -10 to +10 millivolts. Both functions have full-scale pen travel. The combination of scale multipliers on the D.C. microvolt amplifier and the recorder provides a range of sensitivities of from 5 microvolts to 2000 microvolts half-scale deflection, or 1 microvolt to 400 microvolts per inch of chart.

In general, the temperature range and other conditions of the work will determine the composition of the differential thermocouples. It is considered that Pt vs. Pt/13% Rh difference couples are probably most satisfactory because of their stability and high temperature range. However, both chromel-alumel and platinel couples generate approximately four times the emf produced by the Pt/Rh-alloy couples and this greater sensitivity may be a very desirable feature in connection with some work. Chromel-alumel couples are, of course, quite inexpensive, but are useful only to about 1000°C. The temperature range of platinel couples, on the other hand, extends to about 1300°C, while their cost is approximately two-thirds that of Pt/Rh alloy couples.

#### OPERATION AND PERFORMANCE OF THE EQUIPMENT

It is customary, at the start of a DTA run, to put enough power initially, as determined by experiment, into the furnace element so that, when the sample holder reaches 75° or 80°C, the temperature curve will be at the correct slope for the heating rate selected for the test. The furnace-control equipment is then put into operation and a smooth temperature curve will be obtained.

In the case of the Kanthal-element furnaces, as previously described, it has been found that, in general, an initial power-input of 180 to 200 VA and a rate of voltage increase of 1 volt in 2 minutes will produce a rate of temperature increase of 12 deg C per minute. The figures given for the initial power-input and rate of voltage increase will, of course, have to



be adjusted for a particular furnace because of slight variations in characteristics that may occur from furnace to furnace. The settings for various heating rates may easily be determined experimentally. In the case of the Pt/Rh-element furnace, it has been found that, for a heating rate of 12 deg C per minute, an initial input of 325 to 350 VA is required. At about 75°C, the power input should be readjusted to the initial figure and the motor-driven "Variac" put into operation to give a rate of voltage increase of 1 volt per minute.

Successful differential thermal analysis depends to a considerable extent on the ability of the apparatus to produce a satisfactory differential base line. Ideally, if there is no thermal activity in the sample, the base line that is produced should be straight and on the zero line of the millivolt scale of the recorder. Such a base line would require the establishment of several ideal conditions, that may be summarized as follows:

- (a) equal masses and equal volumes of sample of reference material, which implies careful attention to packing or tamping and to grain sizing;
- (b) the thermal properties, such as conductivity, heat capacity, etc., of the sample and reference material should be the same;
- (c) the thermoelectric characteristics of the two junctions of the difference couple must be equal and the junctions must be exactly centred in the sample and the reference material during a run; and
- (d) the geometry of the arrangement in the furnace must be such that the heat effect from the furnace element is exactly equal on both the sample and the reference material cells.

However, in practice, conditions (a) and (b) do not lend themselves to rigid control and the effect of variations from the standard conditions as outlined will be to cause the rate of heat transfer from the furnace to the difference-couple junction in the sample to be different from the rate of heat transfer to the difference-couple junction in the reference material. This will set up a differential emf between the couple junctions and, depending on the polarity of the emf, will cause a shift of the base line to one side or to the other of the centre line of the millivolt scale, the magnitude of the shift depending, in part, on the heating rate obtaining at the time. A shift of the base line will also be produced by an imbalance of the thermoelectric properties of the two junctions of the difference couple (condition "C" above), thus causing unequal responses to the same heat stimulus.

Although the base line that is produced may be off-centre for a given set of non-ideal conditions, it will be straight and probably parallel, or nearly so, to the centre line of the millivolt scale, provided that the

heating rate is linear. A non-linear heating rate can result in a continuously-shifting base-line that may be smooth but that will continue to diverge from the centre line during the heating. If, in addition, the heating rate, as well as being non-linear, is also cycling or fluctuating, then the base line will shift back and forth, or toward and away from the centre line of the chart, and, consequently, will produce a series of spurious peaks or flexures on the differential trace.

Except in special cases, the sample and reference material used in DTA studies are in powder form. The reference material commonly used is ignited aluminum oxide powder ( $\alpha$ -alumina). If necessary, it is usual to grind or crush the substance to be tested to pass through a 100-mesh sieve, after which a representative sample is taken for DTA purposes. As mentioned earlier, careful attention should be given to the packing or tamping of the sample and of the reference material in the sample holder. Consistency of technique in this regard will help to ensure the same degree of packing from run to run and will thus contribute towards ensuring consistency in the results that are obtained.

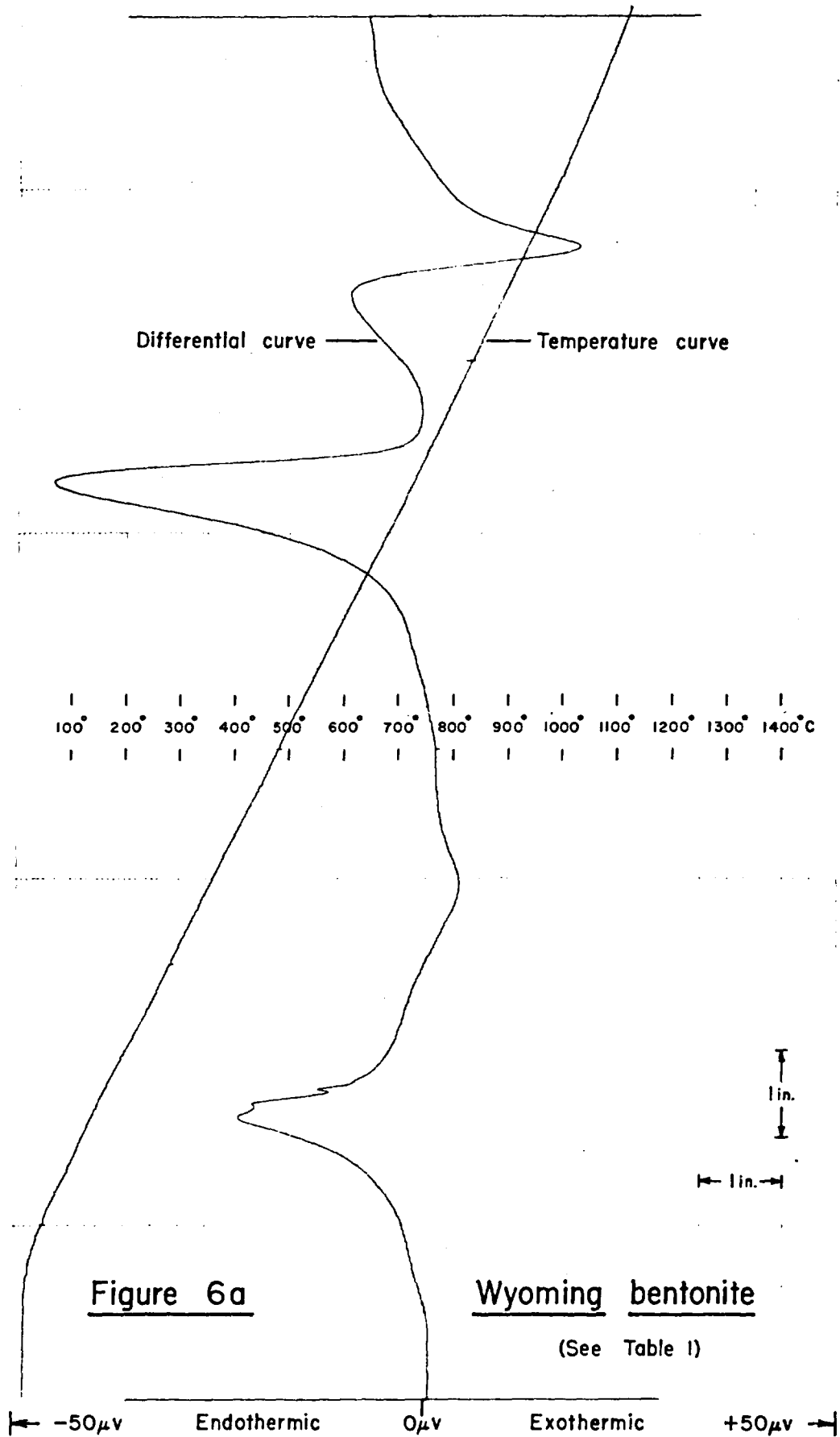
Figures 6a, 6b and 6c are reduced photographic reproductions of DTA charts that are typical of the results that can be obtained with the equipment described herein. Table 1 outlines the conditions under which the runs on these particular materials were made.

TABLE 1

Conditions of Test in Typical DTA Examinations

	Figure 6a	Figure 6b	Figure 6c
Substance tested	Bentonite clay mineral	Dolomite	Quartz
Sample weight	420 mg	600 mg	500 mg
Atmosphere	Static air	CO <sub>2</sub> at 500 ml/min	Static air
Sensitivity	10 $\mu$ v/inch or 50 $\mu$ v half-scale	50 $\mu$ v/inch or 250 $\mu$ v half-scale	10 $\mu$ v/inch or 50 $\mu$ v half scale
Rate of temperature rise	12 deg C per min	12 deg C per min	12 deg C per min

Difference couple - Pt vs. Pt 13% Rh. Chart Speed - 9 in./hr



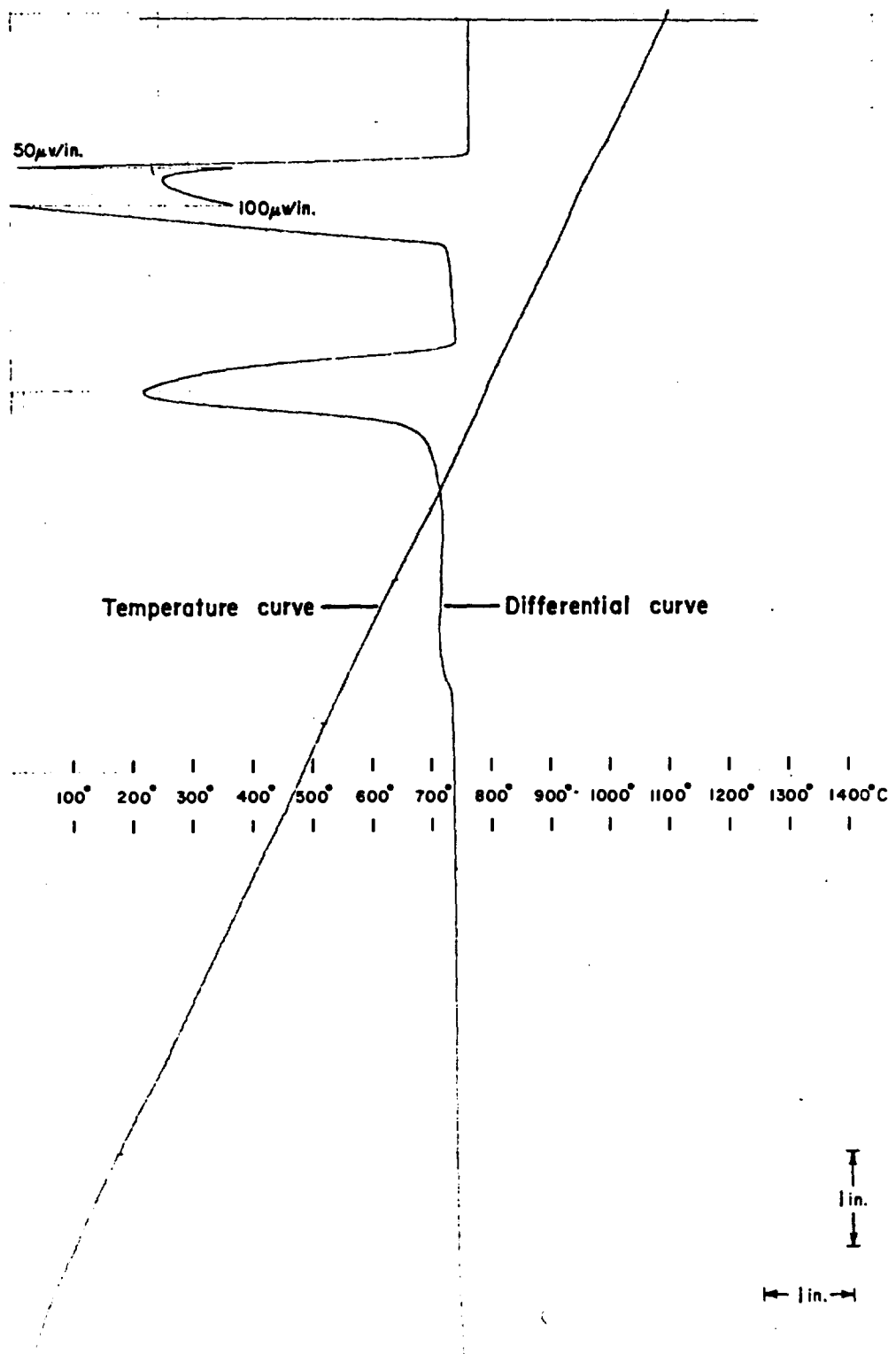
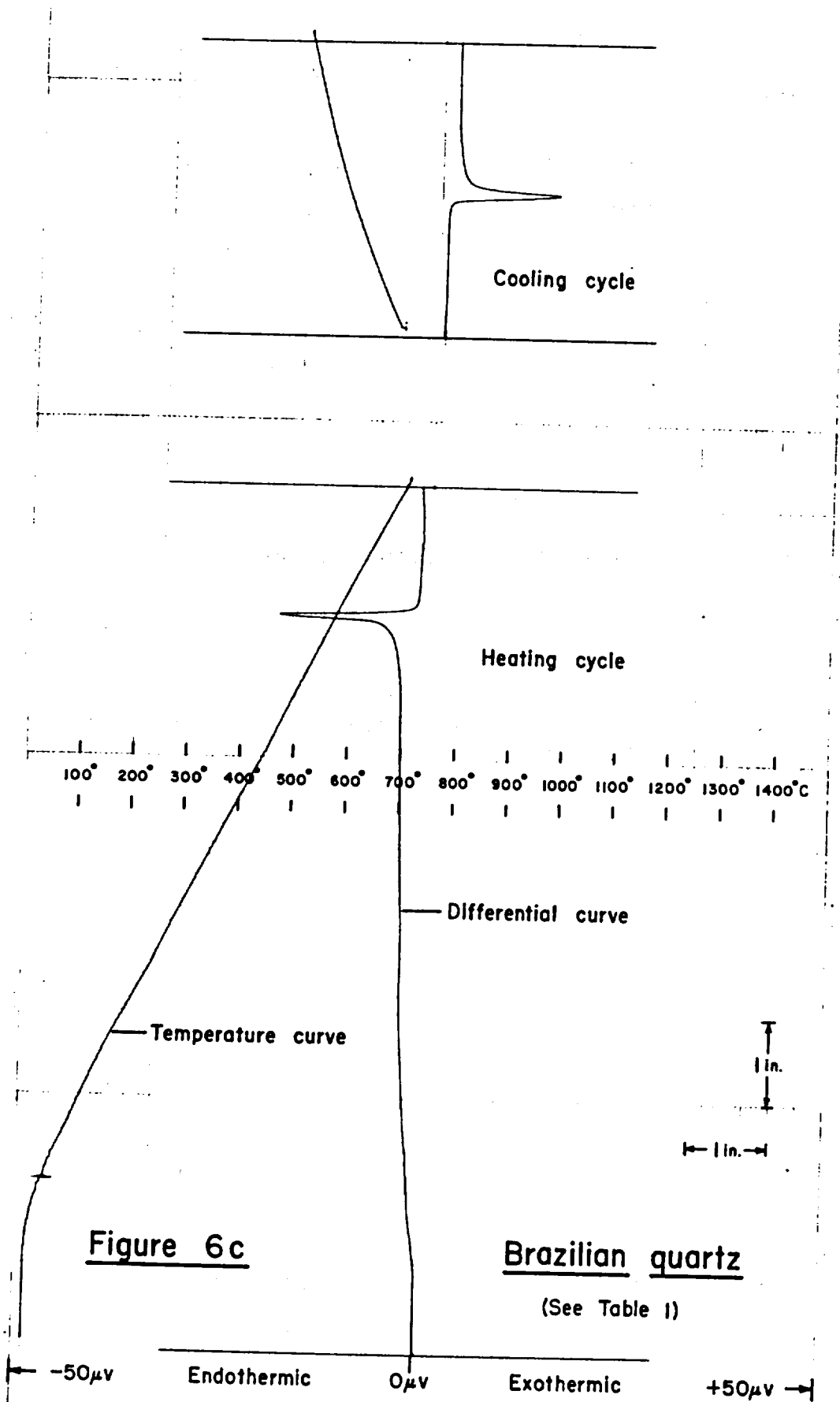


Figure 6b

Dolomite

(See Table I)

← -250 μV      Endothermic      0 μV      Exothermic      +250 μV →



It should be pointed out that these figures depict the actual curves obtained in the experiments themselves and have not been smoothed out in any way. It will be observed that there is little or no evidence of instrumental "noise" effects. The measuring system instantaneously and accurately adjusts itself to any change of sensitivity made to record a peak that would otherwise be too big to be accommodated on the chart paper (see Figure 6b).

From the magnitude of the  $\alpha \leftrightarrow \beta$  quartz inversion peak, recorded on Figure 6c, it will be seen that quite small percentages of quartz in a mixture could be detected and semi-quantitatively estimated. In practice, it has been found possible, under favourable circumstances, to detect concentrations of quartz as low as 1-2% of the sample weight, which is noticeably better than can be achieved by X-ray diffraction.

In a series of tests with similar materials, where it has been desired to compare the proportions of one or more constituents in the various samples under test, considerable success, of a good semi-quantitative nature, has been achieved by cutting out and weighing the peaks that are diagnostic for the presence of the materials concerned. In such work, a judicious selection of base-line is important. From a knowledge of the weight of test sample, its specific heat, and the sensitivity of the equipment, it is possible to deduce enthalpy effects quite successfully from the integrated areas under the peaks.

#### AVAILABILITY OF ITEMS USED IN THE CONSTRUCTION OF THE EQUIPMENT

In this section of the report, it is proposed to list many of the commercially available items that were actually used in the construction of the equipment that has been described herein.

It is important to realise that it is not the intention of the author to imply that these are either the only such materials available or, indeed, that they were, necessarily, the best available commercially for the particular purpose in hand. This list is given merely for the benefit of any reader who may wish to duplicate all or any part of this equipment. It is not intended to be an endorsement or advertisement of any specific commercial product. All that is implied is that the items listed were used in this work, were found to be satisfactory for their respective purposes, and were obtained from the suppliers listed, where these are quoted.

Since this equipment has been built and modified during a period extending over several years, it is considered that it would not serve any useful purpose to quote the prices of the various items of equipment at the time they were obtained, since these prices would, in many instances, bear

little relation to those currently operative. The items of equipment and the suppliers are listed under several self-explanatory headings.

1. Recording Equipment

- (a) Leeds and Northrup No. 9835-B stabilized D.C. microvolt amplifier with scale multiplier.
- (b) Leeds and Northrup, type G, Speedomax, X<sub>1</sub>-X<sub>2</sub> 10-inch strip-chart recorder, with millivolt scale multiplier and other specifications as given in the body of the report. Temperature ranges and desired chart speeds also should be specified.

2. Furnace Control Equipment

- (a) Boston "Ratiotrol" variable-speed drive, consisting of:
  - (1) R-12 variable-transformer motor-speed control, speed range of 175 to 6 R.P.M. at 15 inch-lb torque constant.
  - (2) AASD, DC shunt motor, flanged, 1/12 H.P. at 1750 R.P.M.
  - (3) Model UF-109-10 flange for motor reductor.Available from: Renold Chains Canada, Ltd.  
or: Boston Gear Works, Quincy, Mass., U.S.A.
- (b) General Radio Company Type W20G2 "Variac" auto-transformer, 2-gang in series.

3. Furnace Resistance Wire

- (a) Kanthal wire, made by A.B. Kanthal, Hallstahammar, Sweden.  
Available from: Ferro Enamels of Canada, Ltd.,  
Oakville, Ontario.
- (b) Platinum/rhodium alloy wire, available from:  
Engelhard Industries of Canada, Ltd.  
or  
Johnson, Matthey and Mallory, Ltd.

4. Furnace Refractories

Element tubes and sample holder tubes available from:

- (a) McDanel Refractory Porcelain Company,  
Beaver Falls, Penna., U.S.A.
- (b) Morganite Canada, Ltd.,  
Toronto, Ontario.
- (c) Norton Company of Canada, Ltd.,  
Hamilton, Ontario.

5. Thermal Insulation

- (a) Bubble alumina: available from Norton Co. (address above)
- (b) Magnesium oxide, light powder, U.S.P., available from:
  - (1) Canadian Laboratory Supplies, Ltd.
  - (2) Central Scientific Company
  - (3) Fisher Scientific Co. Ltd.

6. Thermocouple Wire and Sample Holders

- (a) Pt vs. Pt/13% Rh-alloy thermocouple wire (26- or 28-gauge B. & S.)  
Palladium and Pt/Rh-alloy sample-holders available from:
  - (1) Engelhard Industries of Canada, Ltd.
  - (2) Johnson, Matthey and Mallory, Ltd.
- (b) "Platinel" thermocouple wire available from:  
Engelhard Industries of Canada, Ltd.

7. Thermocouple Insulating Sheaths

- (a) Refractory porcelain tubing, unglazed, open both ends, 0.025-in. I. D.,  
0.078-in. O. D., 10 in. long
- (b) Catalogue No. 2T13218-12 round, double-bore, insulating tubing
- (c) " " 2T025332-12 " " " " " "
- (d) " " 4T04614-12 " four-hole " "

Available from: McDanel Refractory Porcelain Company



ACKNOWLEDGEMENTS

The writer wishes to thank all those who have contributed to the construction and development of the DTA equipment used in the Physical Chemistry Laboratories. Acknowledgement is given to Mr. S. A. Forman, now of the Science Secretariat of the Privy Council, formerly of the Mines Branch, who initiated the construction of the DTA equipment and who guided its development through the earlier stages. Thanks are also due to the personnel of the Technical Services Division, Mines Branch, and to Mr. J. F. Tippins, Technician, Physical Chemistry Section, for the construction of and assistance in the assembly of some of the components. The later stages of the construction and development of this equipment and the preparation of this report were supervised by Dr. Norman F. H. Bright, Head, Physical Chemistry Section, Mineral Sciences Division, Mines Branch.

RHL/pg

- (a) Kanadi wire, made by A. B. Kanadi, Hallsborough, Sweden. Available from: Fort-Pole, 4104014-12
- (b) Platinum wire, available from: Ontario, Ontario, Canada, Ltd.
- (c) Johnson, Matthey and Mallory, Ltd.

4. Furnace Refractories

- Element tubes and sample holder tubes available from:
- (a) McDanel Refractory Porcelain Company, Beaver Falls, Penna., U.S.A.
  - (b) Morganite Canada, Ltd., Toronto, Ontario.
  - (c) Norton Company of Canada, Ltd., Hamilton, Ontario.