



CANADA

DEPARTMENT OF MINES AND
TECHNICAL SURVEYS, OTTAWA

MINES BRANCH
TECHNICAL BULLETIN

TB 11

PRICE 25 CENTS

Library

5

A VISCOMETER FOR MINERAL SUSPENSIONS

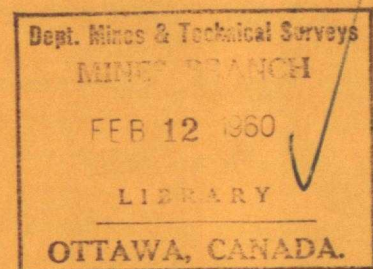

by
G. R. PURDY AND G. G. EICHHOLZ

MINERAL SCIENCES DIVISION

(REISSUE OF INVESTIGATION REPORT IR 58-211,
BY G. R. PURDY, DATED AUGUST 15, 1958.)

DECEMBER 10, 1959

Mines Branch Technical Bulletin TB 11

A VISCOMETER FOR MINERAL SUSPENSIONS

by

G.R. Purdy^A and G.G. Eichholz^{AA}

--

SYNOPSIS

The measurement of the viscosity of mineral slurries, using a modified falling-ball viscometer, is described. In the system used, a plummet was pulled vertically through the slurry under test at a rate governed by an external weight. The velocity of the plummet was established by means of two Geiger tubes outside the viscometer tube, which were actuated by a small radioactive source inside the plummet.

The viscosity of suspensions of glass balls, barite and galena was compared at different rates of shear, and the variation in flow characteristics, in particular the non-Newtonian nature of the viscosity of the mineral slurries, was clearly demonstrated. The use and limitations of a viscometer of this kind, for measuring the viscosity of slurries, are discussed.

^A Summer Assistant, from the University of Alberta, Edmonton, Alta. This report describes work done during the summer 1958 while employed at the Radioactivity Division, Mines Branch, Department of Mines and Technical Surveys, Ottawa, Canada.

^{AA} Head, Physics and Radiotracer Section, Mineral Sciences Division, Mines Branch, Department of Mines and Technical Surveys, Ottawa, Canada.

Direction des Mines, Bulletin technique TB 11

VISCOSIMÈTRE POUR MINÉRAUX EN SUSPENSION

par

G.R. Purdy^A et G.G. Eichholz^{AA}

- - -

RÉSUMÉ

Le présent bulletin décrit un viscosimètre à bille immergente modifié, servant à mesurer la viscosité de pâtes aqueuses minérales. Cet appareil se compose d'un plongeur tiré verticalement à travers la pâte à l'essai à une vitesse réglée par un poids extérieur. La vitesse de ce plongeur est déterminée au moyen de deux compteurs de Geiger placés en dehors du tube du viscosimètre et qui sont soumis à l'action d'une petite source radioactive placée à l'intérieur du plongeur.

On a comparé la viscosité de billes de verre, de barytine et de galène en suspension, soumises à des taux de cisaillement variables. Ces essais ont démontré clairement la variation des caractéristiques d'écoulement, notamment l'inapplicabilité de la loi de Newton à la viscosité des pâtes minérales. Le présent bulletin traite de l'emploi et des limites d'un viscosimètre de ce genre, pour la détermination de la viscosité de pâtes aqueuses.

^AAide saisonnier venant de l'université de l'Alberta, à Edmonton (Alb.). Les travaux décrits ici avaient été exécutés au cours de l'été 1958, alors Mr. Purdy était à l'emploi de la Division de la radioactivité, Direction des Mines.

^{AA}Chef de la Section de la physique et des radioindicateurs, Division des sciences minérales, Direction des Mines, ministère des Mines et des Relevés techniques, Ottawa (Canada).

CONTENTS

	<u>Page</u>
Synopsis	i
Résumé (French translation)	ii
Introduction	1
Experimental Apparatus and Procedures	2
Experimental Results, and Discussion	17
Conclusions	30
Acknowledgments	34
References	35
Appendix - Estimation of Flow Distribution in Annulus for Non-Newtonian Fluids	36

--

FIGURES

<u>No.</u>		<u>Page</u>
1.	- Sketch of slurry viscometer	3
2.	- Detail of slurry viscometer	4
3.	- Photograph of viscometer tube	6
4.	- Photograph of complete apparatus	6
5.	- Variations of the viscosity of standards with temperature	7
6.	- Calibration, falling sphere viscometer	9
7.	- Velocity distribution in annulus... ..	11
8.	- Calibration, slurry viscometer	14
9(a)	- Flow curve for barite	19
9(b)	- Apparent viscosities of barite	20
10(a)	- Flow curve for galena	22
10(b)	- Apparent viscosities of galena	23
11.	- Viscosity of suspensions of glass spheres	26
12.	- Flow curves for galena and glass suspensions	27
13.	- Variation of η^* and m with galena concentration..	29
14.	- Flow curve for various suspensions at 45% solids (by volume)	31
15.	- Photomicrographs of barite particles, glass spheres, and galena particles	32

INTRODUCTION

This project was initiated in order to develop a simple viscometer suited to the investigation of the rheology of suspensions, a phase of fluid flow which has attracted considerable interest in recent years. The use of "fluidized solids" is becoming popular for bulk materials transport systems, due to low cost, cleanliness, and simplicity.

In the case of most liquids, the unit shearing stress applied is directly proportional to the velocity gradient,

$$dF/dA = \eta \quad dv/dx \quad \dots \quad 1)$$

where dF/dA is the shearing stress (measured in dyne/cm²), dv/dx is the velocity gradient (measured in sec⁻¹), and η is the proportionality factor known as the viscosity (measured in poise = $\frac{\text{dyne sec}}{\text{cm}^2}$).

If the fluid is a simple (Newtonian) fluid, its rheological behaviour is completely defined by a single viscosity coefficient for all rates of shear. If the viscosity varies as the rate of shear is varied, the fluid is termed non-Newtonian, and can best be defined by a curve showing the relation of viscosity to rate of shear. In general, suspensions and slurries are non-Newtonian fluids.

When viscosity is a function of the rate of shear, it follows that the differential equations differ from those holding for Newtonian liquids. What is obtained in the viscometry of non-Newtonian fluids is a series of "apparent viscosities", each equal to the viscosity of a simple liquid producing the same flow under identical conditions in the particular apparatus used.

EXPERIMENTAL APPARATUS AND PROCEDURES

The method of determination of apparent viscosities consists in applying a constant force to a sphere in a uniform vertical tube containing the material to be tested. The time required for the sphere to travel a fixed distance after reaching terminal velocity is proportional to the apparent viscosity of the fluid.

Timing is accomplished by inserting a small radioactive pellet into the sphere and allowing it to pass two matched, collimated and shielded Geiger tubes. As the sphere passes the first tube, the burst of pulses is amplified and fed to a relay unit which starts a scaler counting 60 cps when the count rate exceeds a chosen level. Similarly, the scaler is stopped when the sphere passes the second Geiger tube (see Figure 1). The reading on the scaler register is, therefore, inversely proportional to the velocity of the sphere.

In this instrument, the force on the sphere is applied by means of a system of external weights. This method allows the alteration of the force on the sphere, making it possible to determine the flow characteristics of the suspensions at various rates of shear.

The sphere, a $5/16$ in. bronze ball, is attached to a nylon monofilament thread which is passed over two pulleys mounted on ball bearings at either end of a copper tube (34 in. long and 0.55 in. I. D.). At each end of the tube, the thread passes through a small hole in a fitted brass plug, allowing a minimum of leakage (Figure 2). This system ensures that the ball will be central in the tube.

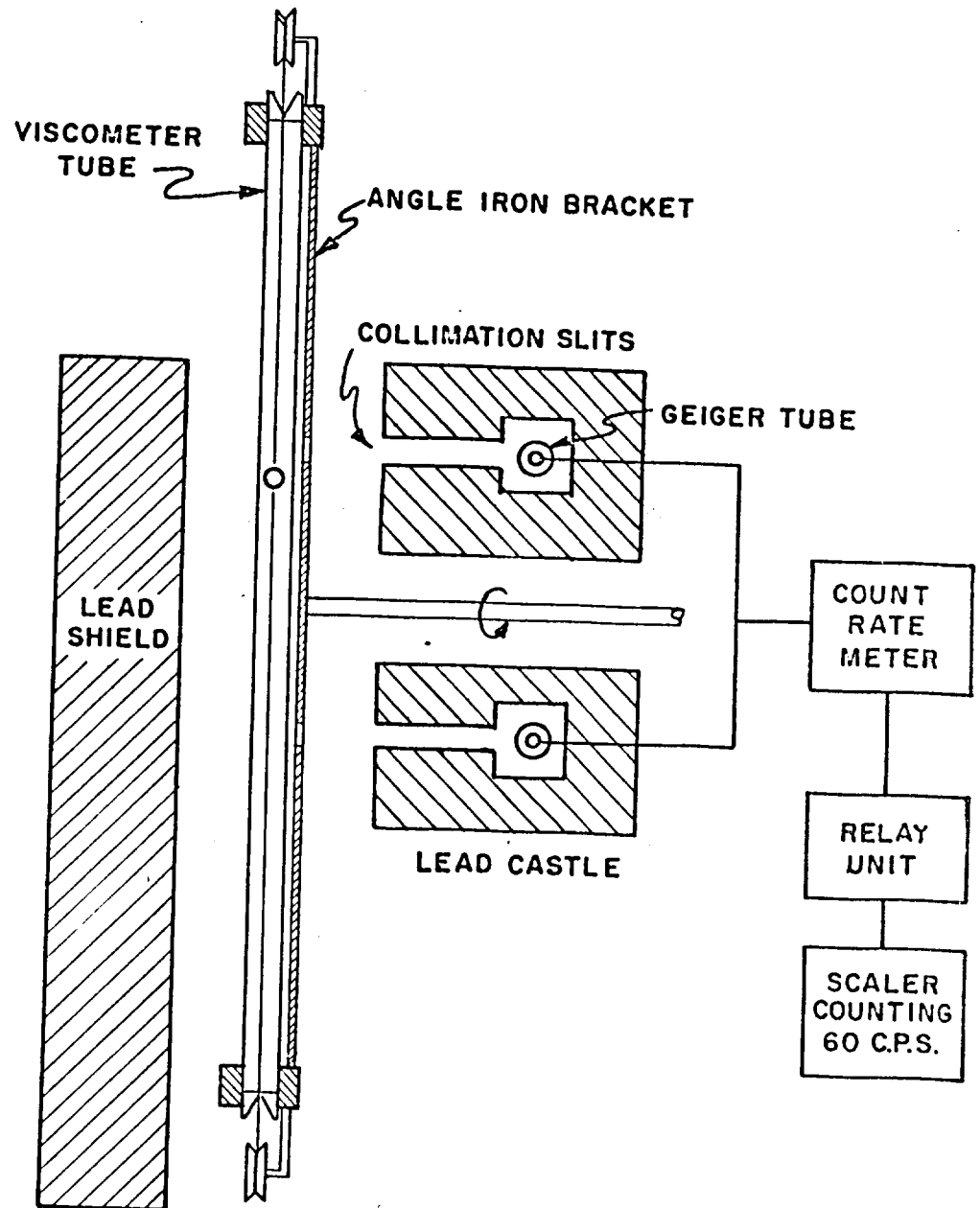

FIG. 1 - SKETCH OF SLURRY VISCOMETER.

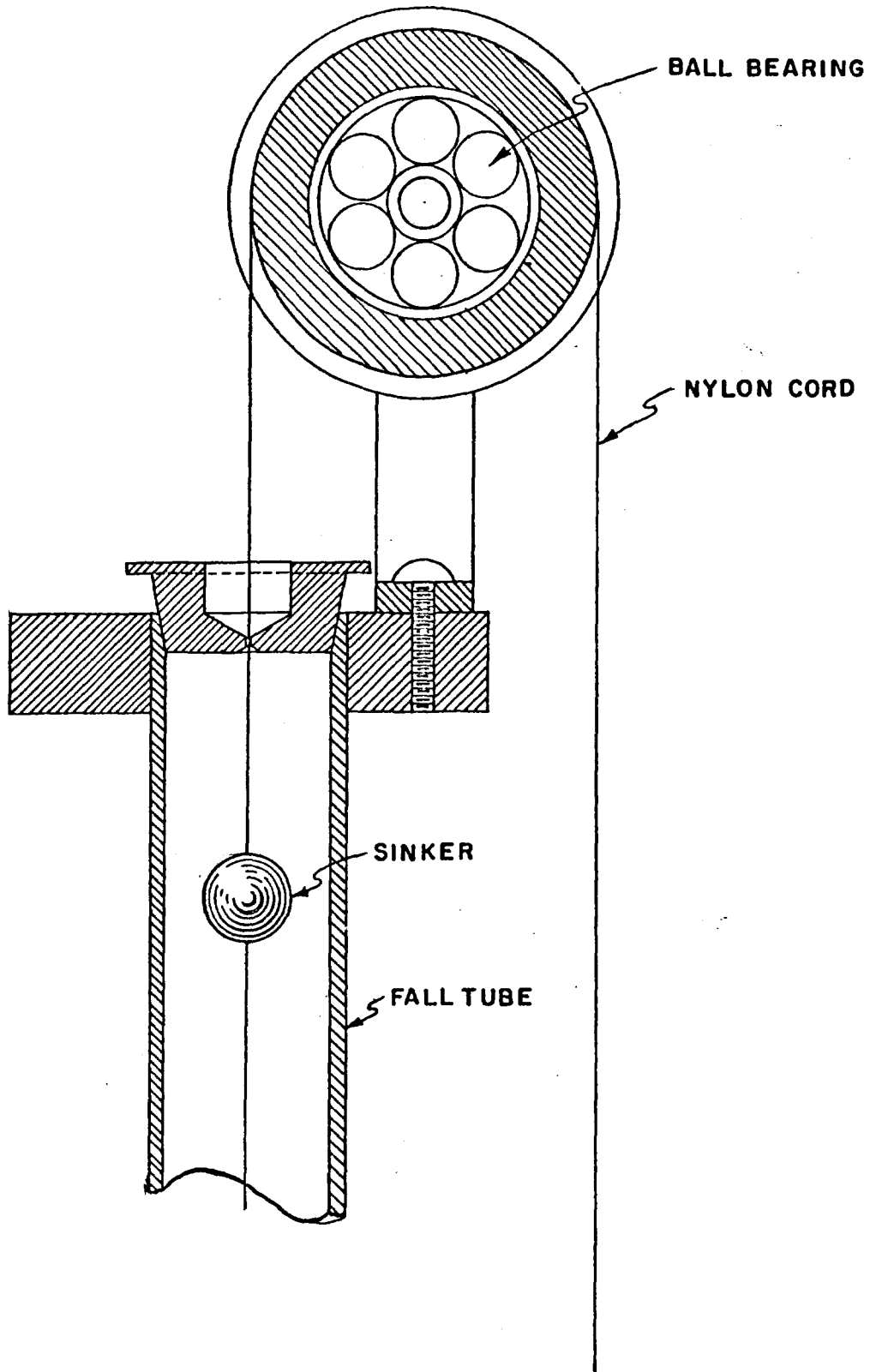

FIG. 2- DETAIL OF SLURRY VISCOMETER.

A fine hole was drilled into the ball and a fine wire of radioactive cobalt was inserted. Approximately one millicurie of cobalt-60 was used in each sinker to ensure positive detection by the Geiger tubes.

The tube is strapped into an angle iron bracket secured to a length of steel rod passing through two pillow block bearings, thus permitting the inversion of the tube in order to minimize settling effects. The bearings are mounted on a Dexion steel frame which also supports the lead castle and detector assembly. Figure 3 shows the copper viscometer tube; the external weight shown is readily exchangeable and a set of weights was prepared to cover the range of shear rates required. Figure 4 shows the complete equipment with the lead shield around the counter tubes in place, but without the additional shield indicated on the left side of Figure 1.

This viscometer is necessarily a relative instrument. Calibration is required in order that the results may be expressed in absolute units. A number of glycerine and water samples, spanning a viscosity range of from 100 to 500 centipoises, was prepared. The viscosity of each was accurately determined at 77°F by means of an absolute capillary viscometer. Because of the great variation of viscosity with temperature, it was found convenient to determine the viscosity of the standards over a range of temperatures. This was accomplished by allowing an activated ball to fall freely in a sealed tube containing the standards at different temperatures (Figure 5).

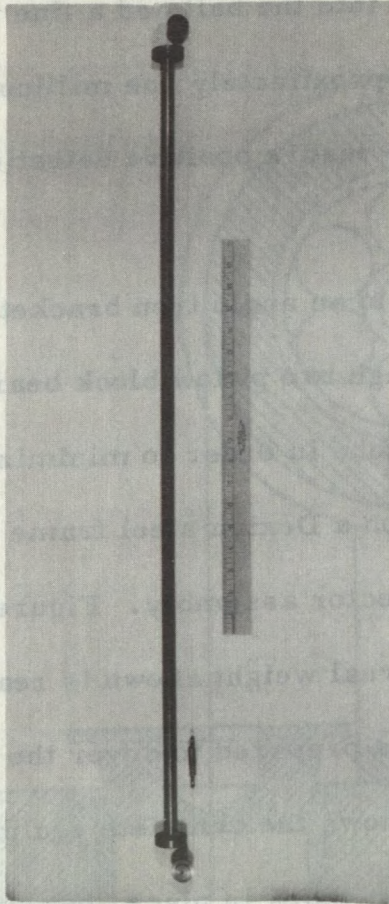

Fig. 3 - Photograph of Viscometer Tube.

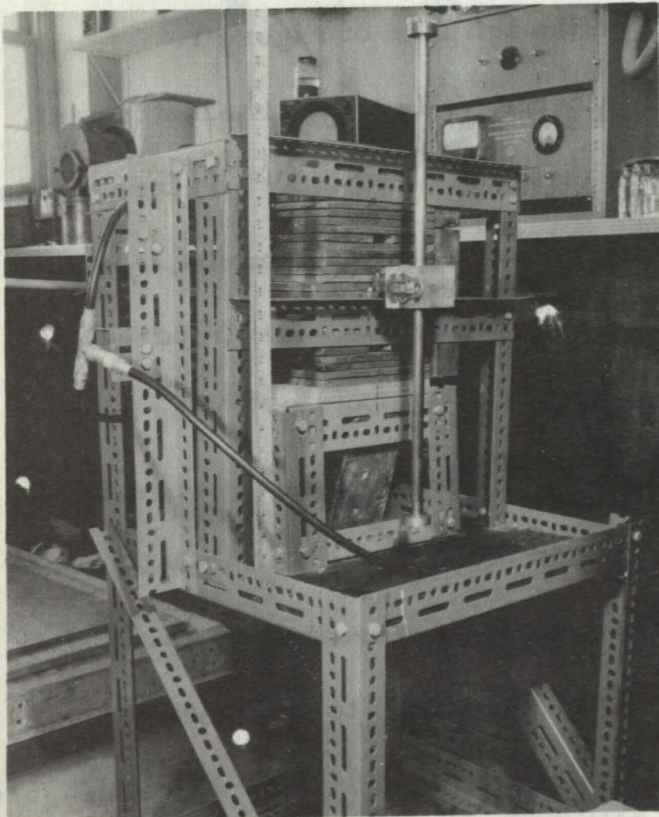

Fig. 4 - Photograph of Complete Apparatus.

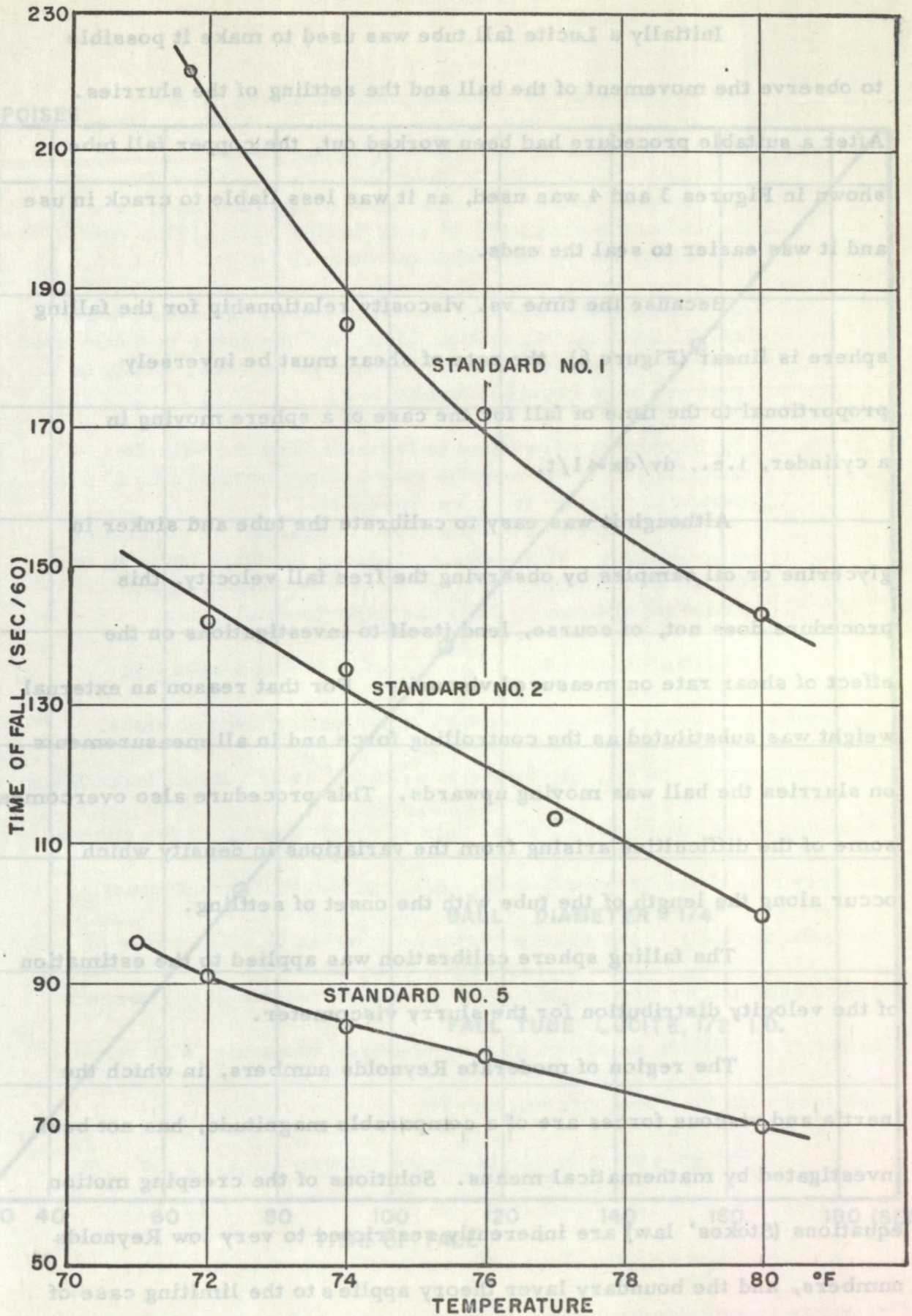

FIG. 5-VARIATION OF THE VISCOSITY OF STANDARDS WITH TEMPERATURE.

Initially a Lucite fall tube was used to make it possible to observe the movement of the ball and the settling of the slurries. After a suitable procedure had been worked out, the copper fall tube shown in Figures 3 and 4 was used, as it was less liable to crack in use and it was easier to seal the ends.

Because the time vs. viscosity relationship for the falling sphere is linear (Figure 6), the rate of shear must be inversely proportional to the time of fall for the case of a sphere moving in a cylinder, i. e., $dv/dx \propto 1/t$.

Although it was easy to calibrate the tube and sinker in glycerine or oil samples by observing the free fall velocity, this procedure does not, of course, lend itself to investigations on the effect of shear rate on measured viscosity. For that reason an external weight was substituted as the controlling force and in all measurements on slurries the ball was moving upwards. This procedure also overcomes some of the difficulties arising from the variations in density which occur along the length of the tube with the onset of settling.

The falling sphere calibration was applied to the estimation of the velocity distribution for the slurry viscometer.

The region of moderate Reynolds numbers, in which the inertia and viscous forces are of a comparable magnitude, has not been investigated by mathematical means. Solutions of the creeping motion equations (Stokes' law) are inherently restricted to very low Reynolds numbers, and the boundary layer theory applies to the limiting case of very high Reynolds numbers (4).

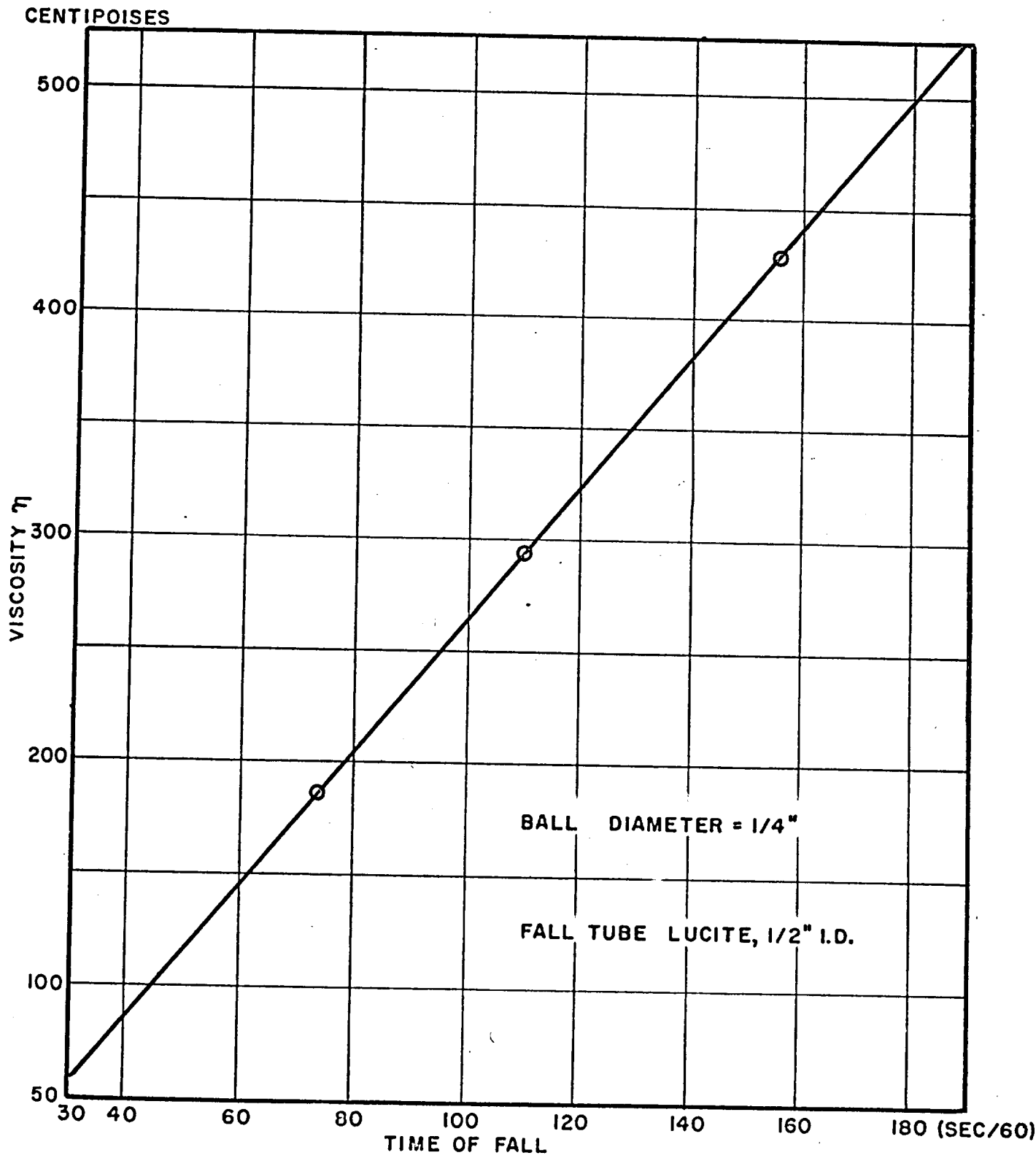

FIG. 6 - CALIBRATION, FALLING SPHERE VISCOMETER.

An estimate of the velocity gradient set up by the moving sphere was based on the following assumptions:

- 1) Roughly 90% of the resistance to the moving sphere is due to the proximity of the cylinder wall. (This can be shown for low Reynolds numbers.)
- 2) The average positive shearing stress acts at an angle of 90° from the stagnation point, and the force is distributed over roughly two-thirds of the sphere surface. (This is true for high Reynolds numbers.)
- 3) Flow past the sphere is laminar, and the velocity distribution in the annulus may be approximated by a parabola (Figure 7). (See Appendix.)

These assumptions admittedly idealize the conditions considerably. However, a rigorous analysis leads to an unduly complicated mathematical formulation which would be difficult to fit to the experimental data.

Equation 2, below, is the result of fitting a parabola by trial and error to the known conditions (pertinent dimensions, sphere velocity, no slip at sphere or cylinder wall). By differentiating equation 2, an expression for the rate of shear normal to the sphere surface was obtained (equation 3). All data were plotted against the rate of shear at the sphere surface (equation 4). The rates of shear obtained by this simplified method give results of the correct order of magnitude as shown by a comparison of results with those obtained with the Fann viscometer (1).

The general equation takes the form:

$$v = a(x - b)^2 + c \quad \dots\dots 2)$$

where v is the fluid velocity (cm/sec), x is the radial distance from cylinder centre (cm), and a , b , and c are constants of the apparatus.

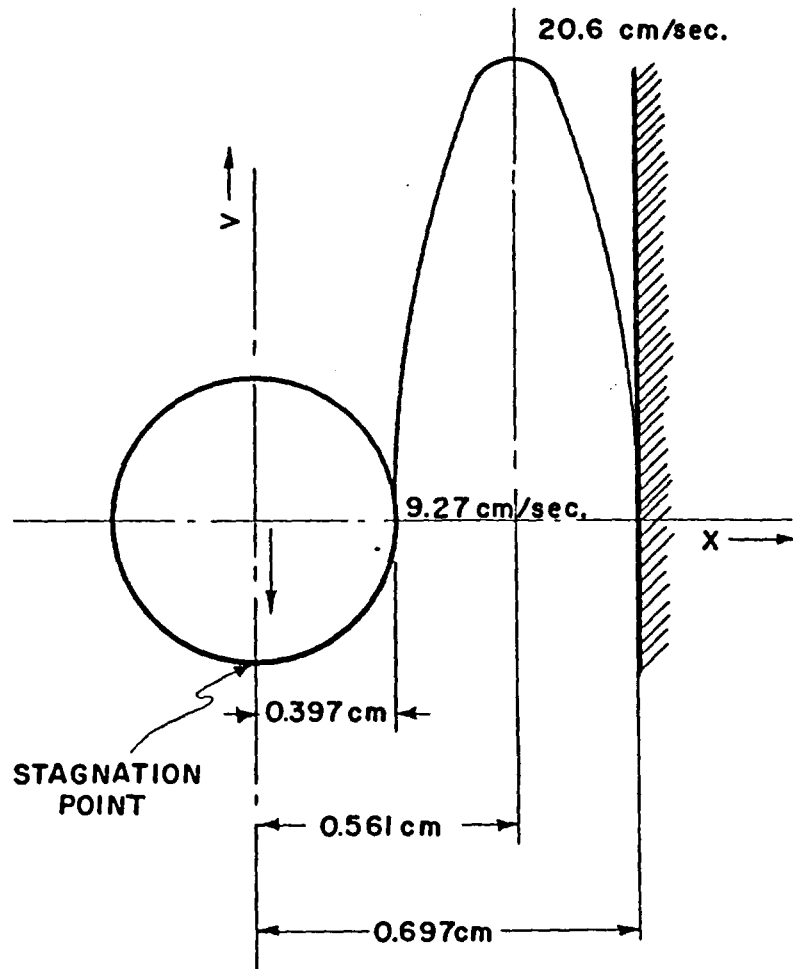

Fig. 7 - Velocity Distribution in Annulus (Copper Fall Tube)

For the present viscometer, with the copper fall tube

ball diameter = 0.794 cm,
tube diameter = 1.395 cm,
ball velocity in fluid of viscosity 2.93 poise = 9.27 cm/sec,
ball density = 8.345,
fluid density = 1.245, and
annulus area = $\pi (0.697^2 - 0.397^2) = 1.034 \text{ cm}^2$.

As the ball falls at 9.27 cm/sec, the volume displacement through the annulus is $14.18 \text{ cm}^3/\text{sec}$; therefore, the average fluid velocity in the annulus is 13.72 cm/sec.

For this particular case: $a = -1113$
 $b = 0.561$
 $c = 20.6$

$$\text{Then } v = -1113 (x - 0.561)^2 + 20.6 \quad \dots 2)$$

$$dv/dx = 2226x - 1249 \quad \dots 3)$$

$$dv/dx \text{ at sphere surface} = 365 \text{ sec}^{-1} \text{ when } t = 110 \text{ sec}/60$$

$$\therefore dv/dx = \frac{4.015 \times 10^4}{t} \quad \dots 4)$$

where dv/dx is the rate of shear in sec^{-1} , and t is the time of fall in $\text{sec}/60$.

$$\begin{aligned} \text{Force on sphere} &= \frac{4}{3} \times \pi \times 0.397^3 \times 981 \times (8.345 - 1.245) \\ &= 1825 \text{ dynes} \end{aligned}$$

$$\begin{aligned} \text{Unit shearing stress, } dF/dA, &= \eta \, dv/dx \\ &= 2.93 \times 365 \\ &= 1070 \text{ dynes/cm}^2 \end{aligned}$$

$$\frac{\text{Force}}{\text{Stress}} = 1.70 \text{ cm}^2$$

or 85% of sphere surface area.

The slurry viscometer was then calibrated to determine the extent and effect of pulley and thread friction. The calibration (Figure 8, Table 1) indicates the same intercept of 1300 dynes/cm² for all standards, and slopes which are proportional to the viscosity factors. Varying the thread diameter did not significantly affect the results. Equation 5, relating shearing stress to external force, is the result of this calibration.

$$\text{Shearing stress } dF/dA = \frac{\text{Total Force} - 342 \dots 5)}{6.46}$$

The following procedure was followed when testing suspensions:

The suspension was agitated until homogeneous, and the specific gravity determined with a pycnometer. The temperature of the fluid was recorded, and, if necessary, adjusted. The viscometer tube was strapped into the angle iron bracket, filled to overflowing with well-mixed suspension, and immediately capped. At least six readings were taken for each shearing force. Weights were added or removed to vary the force on the sphere.

Tests made with barite suspensions have shown that the inversion of the tube after each reading is effective in preventing settling (Table 2) within the experimental accuracy involved. As a precaution, check readings at the initial shearing force were made whenever a suspension was tested at various shearing forces.

Apparent viscosities were determined by dividing the unit shearing stress (obtained with equation 5) by the rate of shear (from equation 4).

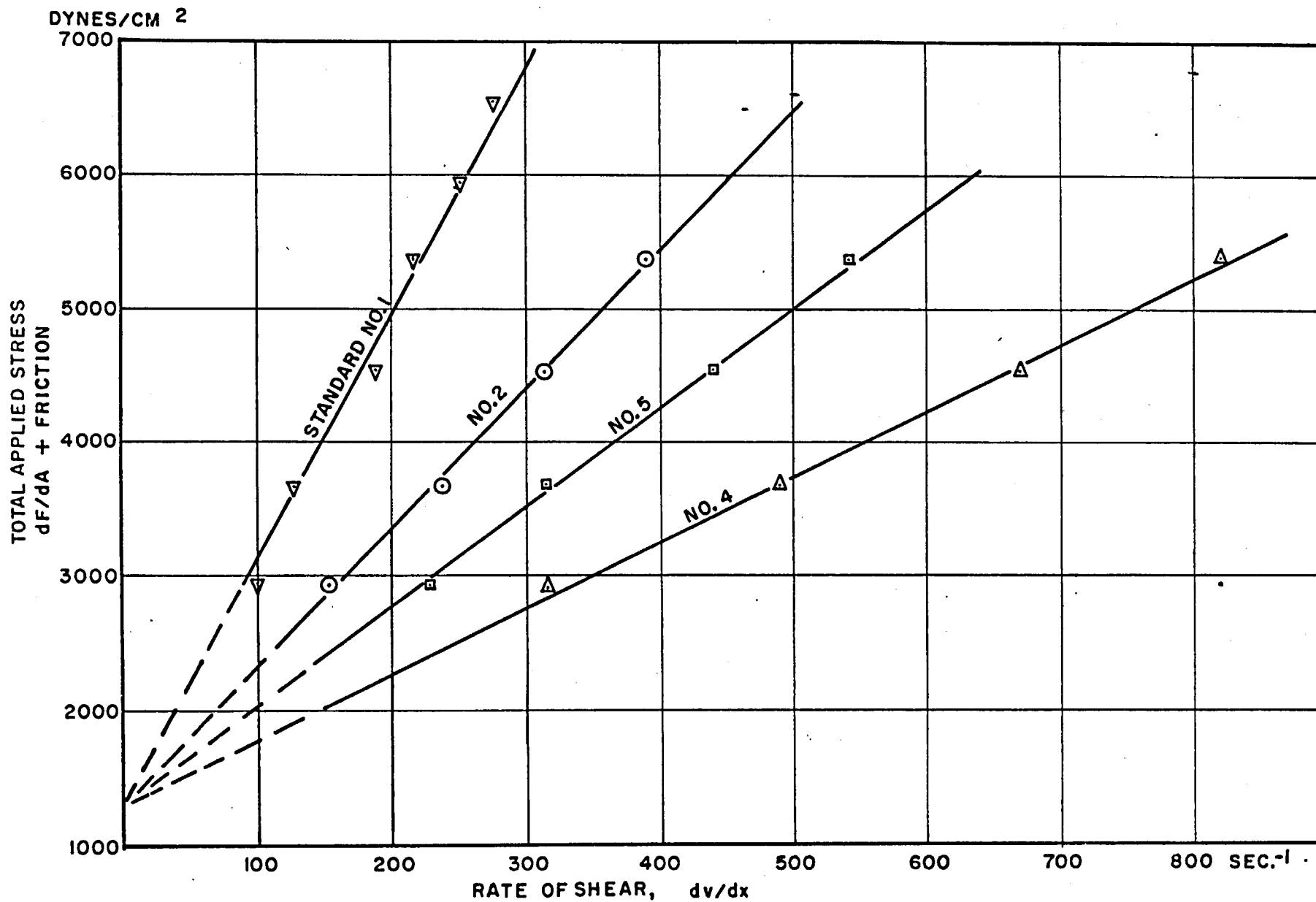

FIG. 8 - CALIBRATION, SLURRY VISCOMETER.

TABLE 1

Calibration of Slurry Viscometer

Force up (dynes)	Force down (dynes)	Total force (dynes)	dF/dA plus friction (dynes/cm ²)	t _{avg} (sec/60)	dv/dx (sec ⁻¹)	Slope	Slope/η
(No. 1 Standard -- η = 490 cp, ρ = 1.248)							
6770	1805	4965	2920	403	99.6		
8077	"	6272	3690	314	128		
9660	"	7855	4620	213	188.5	18.25	3.73
10925	"	9120	5360	185	217		
11906	"	10101	5940	160	251		
12887	"	11082	6520	145	277		
(No. 2 Standard -- η = 293.1 cp, ρ = 1.245)							
6770	1805	4965	2920	262	153		
8077	"	6272	3690	169	238	10.70	3.65
9660	"	7855	4620	128	314		
10925	"	9120	5360	103	390		
(No. 5 Standard -- η = 190 cp, ρ = 1.237)							
6770	1805	4965	2920	175	229		
8077	"	6272	3690	128	314	7.42	3.90
9660	"	7855	4620	91	440		
10925	"	9120	5360	74	542		
(No. 4 Standard -- η = 125 cp, ρ = 1.227)							
6770	1805	4965	2920	128	314		
8077	"	6272	3690	82	490	4.88	3.91
9660	"	7855	4620	60	669		
10925	"	9120	5360	49	820		
						mean	3.80

TABLE 2

Effect of Settling on Indicated Viscosity

Time (min)	TIME OF FALL (sec/60)	
	Barite (sp gr 2.60)	Barite (sp gr 2.37)
0	132	101
	127	96
1	121	107
	122	103
2	112	98
	134	99
3	109	94
	132	106
4	127	99
	136	99
5	126	96
	136	100
6	132	103
	130	98
7	128	99
	118	94
8	122	106
	137	103
9	133	97
	129	103
10	<u>117</u>	<u>96</u>
mean	127	100

EXPERIMENTAL RESULTS, AND DISCUSSION

Suspensions of barite, galena, and glass spheres were investigated with the slurry viscometer. The barite and galena solids were supplied by the Department of Mining and Metallurgy of the University of Alberta. These suspensions had previously been investigated with a Fann concentric cylinder viscometer (1, 5).

The results for barite suspensions are recorded in Table 3 and shown graphically in Figures 9(a) and 9(b). Barite media behave as pseudoplastic fluids, i. e. the apparent viscosity decreases as the rate of shear increases. The departure from Newtonian behaviour diminishes as the rate of shear increases.

To correlate results for different media, attempts have been made to express them in terms of an empirical power law. For barite, the results in Figure 9(b) can be summarized:

$$\eta = (\text{specific gravity})^{0.73} \left(\frac{dv}{dx} \right)^{-0.27} \dots 6)$$

The results obtained with the slurry viscometer are compared with those obtained with the Fann viscometer at the University of Alberta in Figure 14(1). The variation is difficult to explain, and may be due to some difference in the size or shape of the barite particles, since barite is a very soft mineral and, in this series of tests, was reclaimed and used several times. Again, the disagreement may be due to differences in the types of velocity distribution involved in the respective viscometers. However, in both viscometers barite produces the same type of flow curve.

TABLE 3

Barite Media Results

(Temperature, 82°F)

Force up (dynes)	Force down (dynes)	Total Force (dynes)	dF/dA (dynes/cm ²)	t _{avg} (sec/60)	dv/dx (sec ⁻¹)
<u>sp gr 2.39</u>					
a) 6770	1515	5255	471	100	402
b) 8290	1515	6775	706	55	730
c) 9660	1515	8145	920	44	912
<u>sp gr 2.45</u>					
a) 6770	1500	5270	474	121.5	330
b) 8077	1500	6577	675	69	582
c) 9660	1500	8160	922	47	854
<u>sp gr 2.55</u>					
a) 6770	1470	5300	478	160	251
b) 8077	1470	6607	681	92	436
c) 9660	1470	8190	926	67	598
d) 10925	1470	9455	1122	55	730
<u>sp gr 2.60</u>					
a) 6770	1460	5310	480	223	180
b) 8077	1460	6617	682	132.5	303
c) 9660	1460	8200	928	88	456
d) 10925	1460	9465	1124	67	600
<u>sp gr 2.68</u>					
a) 8077	1437	6640	686	213	185
b) 9660	1437	8223	932	127	316
c) 10925	1437	9488	1127	98	410
d) 12887	1437	11450	1431	70	574

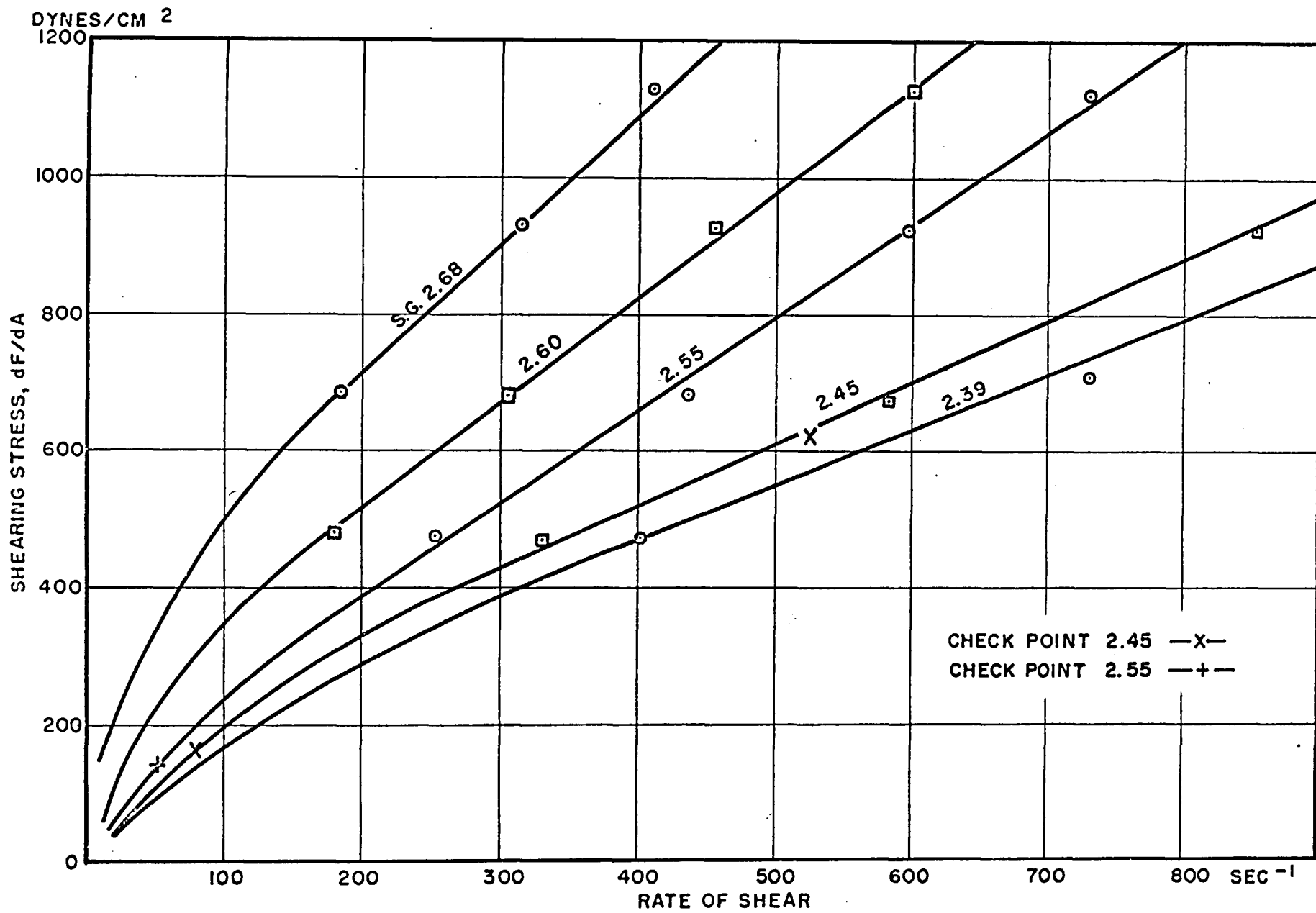

FIG. 9 (a) - FLOW CURVES FOR BARITE.

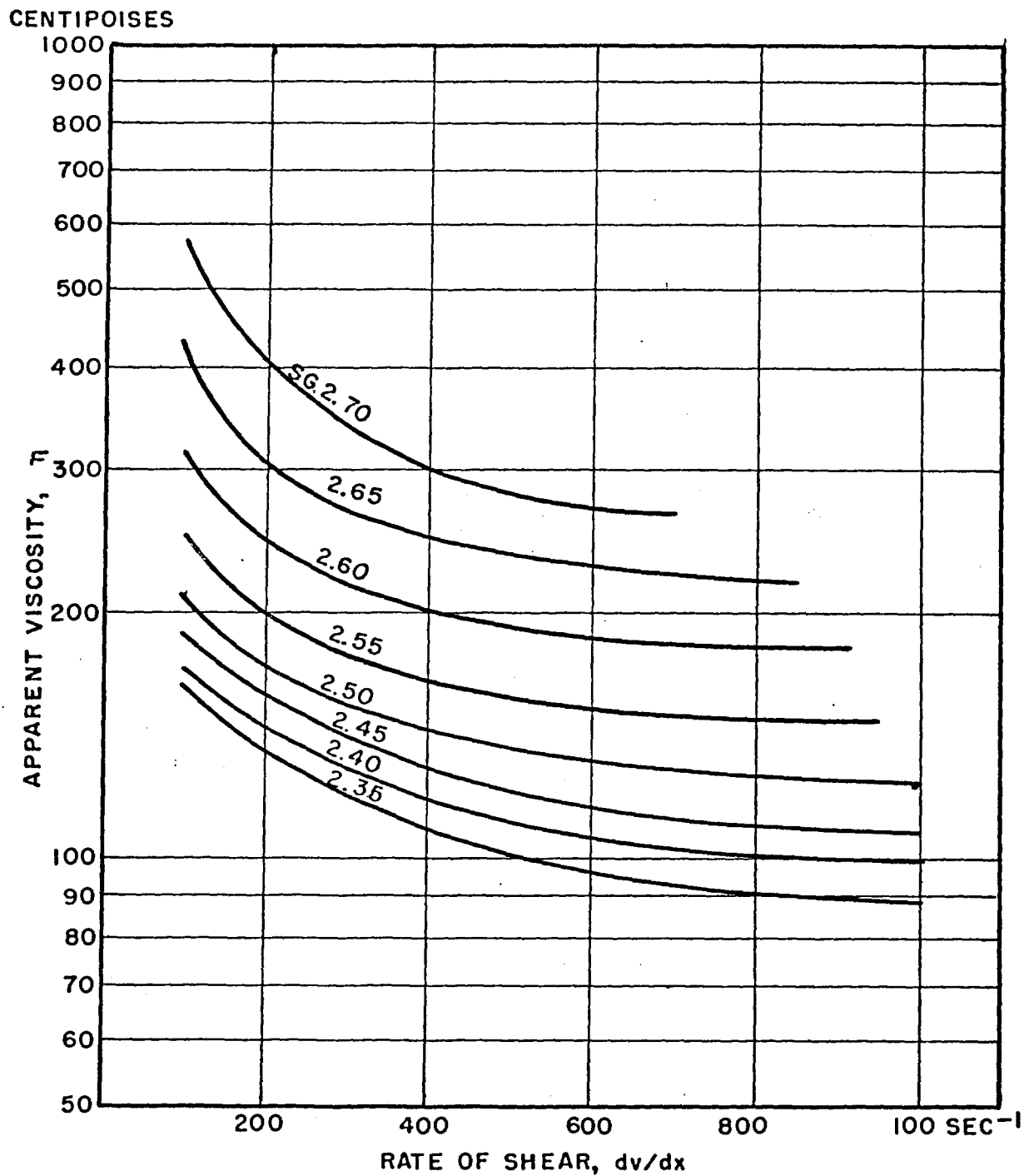

FIG. 9 (b)-APPARENT VISCOSITIES OF BARITE.

Figures 10(a) and 10(b) and Table 4 show the results obtained for suspensions of galena in water. Unlike barite suspensions, galena suspensions do not approach Newtonian behaviour at high shear rates. Galena has a much greater settling tendency than barite, and is, therefore, more difficult to test.

The results obtained at the University of Alberta with the concentric cylinder viscometer and with galena media (5) show a zone in which the apparent viscosity decreases with increasing rate of shear, followed by a zone in which the apparent viscosity increases with increasing rate of shear (Figure 14). The transition occurs at about 300 sec^{-1} . This behaviour, termed dilatancy, was rather vague, however, and appeared to depend on the dimensions of the viscometer. Since the galena suspensions tested in this series of investigations show no tendency toward dilatancy, it is suggested that the phenomenon observed with the concentric cylinder instrument is actually a type of turbulence first noted by W. O. Ostwald (6). This "structural turbulence" occurs in suspensions at subcritical Reynolds numbers, and has been observed by several research workers (2).

A number of suspensions of sized glass spheres in a dispersion medium of glycerine-water solution were tested in the viscometer in an effort to determine the effect of particle size on the viscosity of a suspension when the particle shape factor is constant. It was found that suspensions of glass spheres behave in a Newtonian manner over the ranges of rate of shear and concentration spanned. Within the

DYNES/CM²
1200

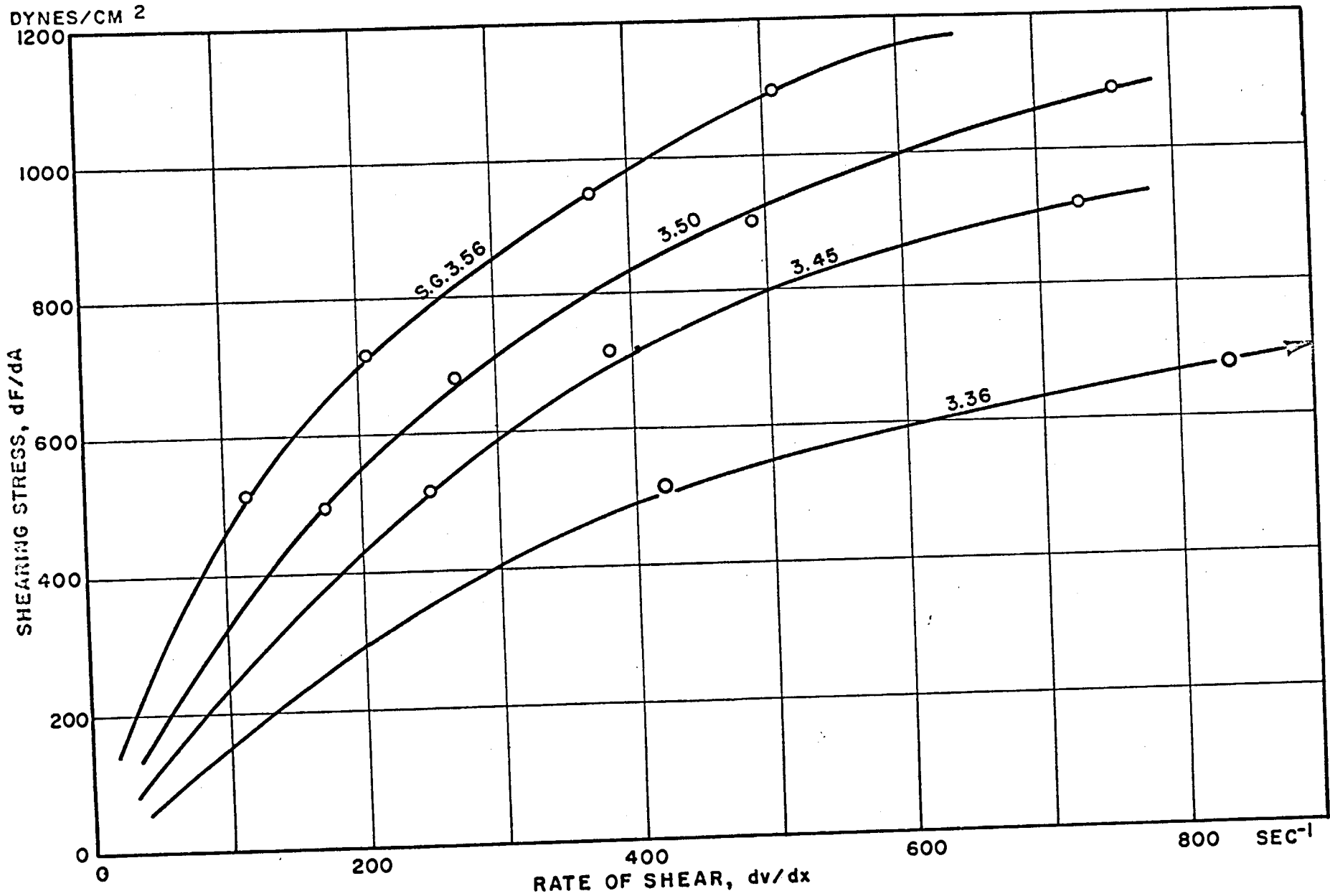

FIG. 10 (a)- FLOW CURVES FOR GALENA.

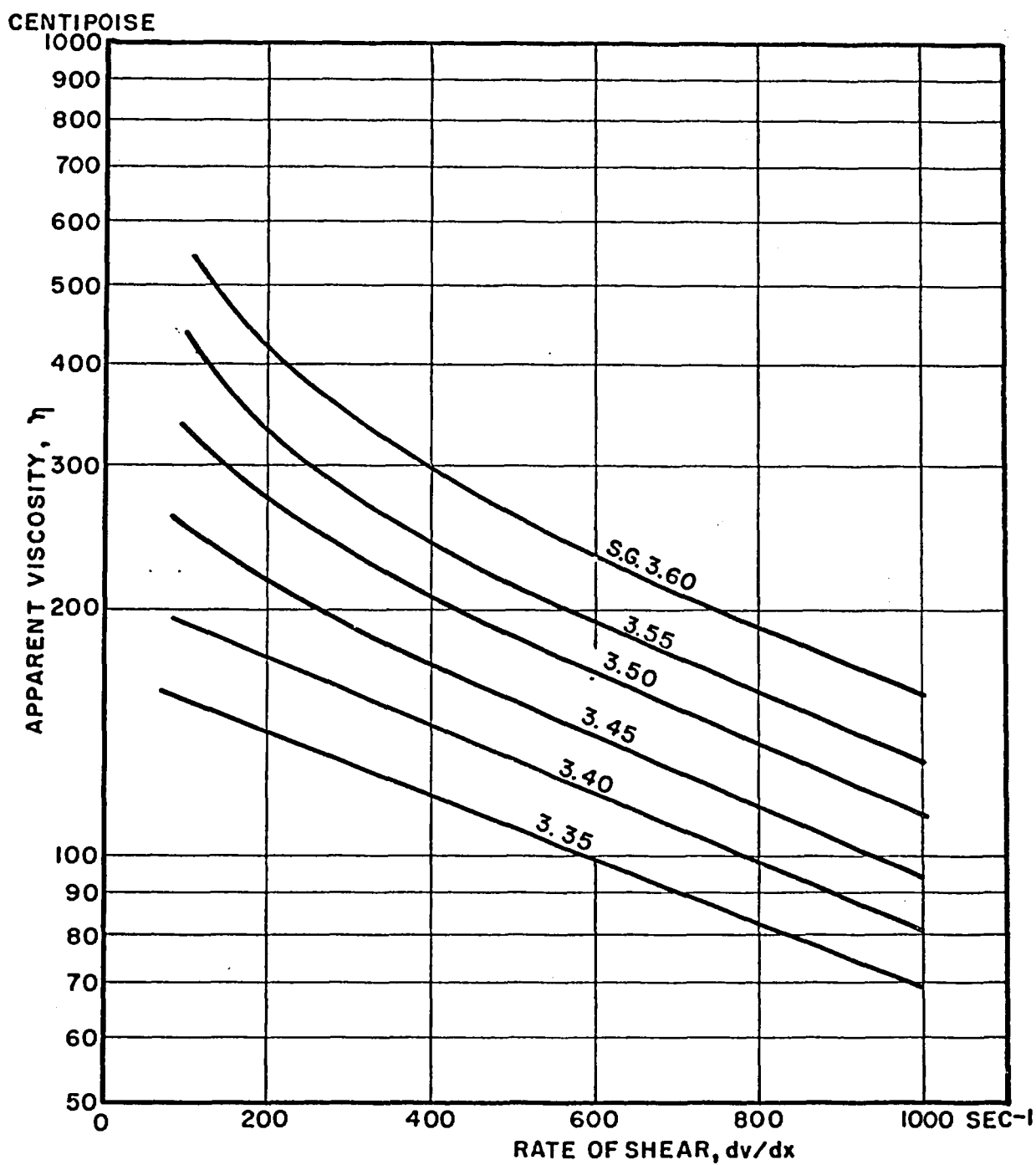

FIG. 10 (b)-APPARENT VISCOSITIES OF GALENA.

TABLE 4

Galena Media Results

Force up (dynes)	Force down (dynes)	Total Force (dynes)	dF/dA (dynes/cm ²)	t _{avg} (sec/60)	dv/dx (sec ⁻¹)
<u>sp gr 3.36</u>					
a) 6770	1250	5520	512	96	418
b) 7830	1250	6580	676	48	836
c) 8810	1250	7560	829	30	1337
<u>sp gr 3.45</u>					
a) 6770	1238	5532	514	161	249
b) 8077	1238	6839	716	105	383
c) 9375	1238	8137	918	55	730
<u>sp gr 3.50</u>					
a) 7830	1230	6600	680	149	270
b) 9223	1230	7993	895	82	490
c) 10453	1230	9223	1086	53	758
free fall			494		173
<u>sp gr 3.56</u>					
a) 6770	1225	5545	516	350	115
b) 8077	1225	6852	718	195	206
c) 9645	1225	8420	946	108	371
d) 10485	1225	9260	1092	79	508

experimental accuracy, the viscosity of the suspensions varied only with the concentration. The variation of viscosity with concentration is evident in Figure 11.

From these observations, it appears that:

- 1) The degree of departure from Newtonian behaviour depends upon the extent of particle interaction.
- 2) The effect of particle size on the apparent viscosity depends upon the extent of particle interaction.
- 3) Particle interaction depends chiefly upon particle shape.

To determine the magnitude of the effect of particle shape a number of suspensions of mixtures of glass spheres and galena particles (effectively cubes) in glycerine-water solution were investigated.

The results (Figure 12, Table 5) were analysed according to the general relation:

$$dF/dA = \eta^* (dv/dx)^m \dots\dots\dots 7)$$

where dF/dA is the shearing stress in dynes/cm²,
 dv/dx is the rate of shear in sec⁻¹,
 m is an exponent which indicates the degree at departure from Newtonian behaviour,
and η^* is a logarithmic function of viscosity which is reduced to the viscosity term under Newtonian conditions.

The result of this treatment is shown in Figure 13.

η^* varies linearly with the amount of galena in suspension, if the total percentage of solids remains constant. m changes rapidly as the first non-spherical particles are introduced, then levels off.

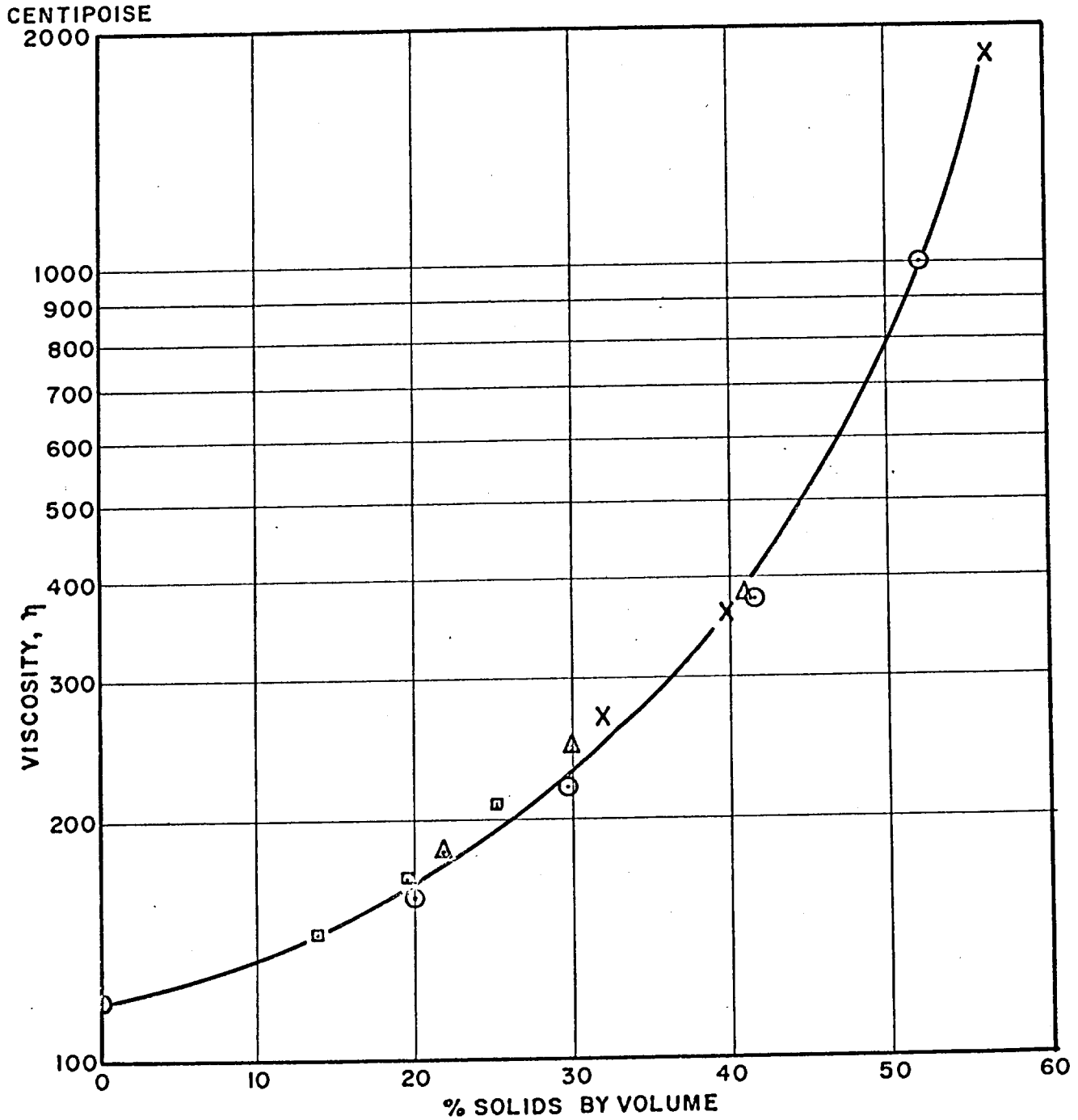

PARTICLE SIZE - \square 34 μ , \circ 48 μ , Δ 58 μ , X 68 μ .
DISPERSION MEDIUM - GLYCERINE SOLUTION.

FIG. II - VISCOSITY OF SUSPENSIONS OF GLASS SPHERES.

$$dF/dA = \eta^* (dv/dx)^m$$

	<u>%SOLIDS BY VOLUME</u>	η^*	m
(1)	30 % GLASS	1.00	1.00
(2)	22.5 % GLASS, 7.5% Pbs	9.62	0.661
(3)	15% GLASS, 15% Pbs	14.28	0.638
(4)	30% Pbs	34.60	0.545

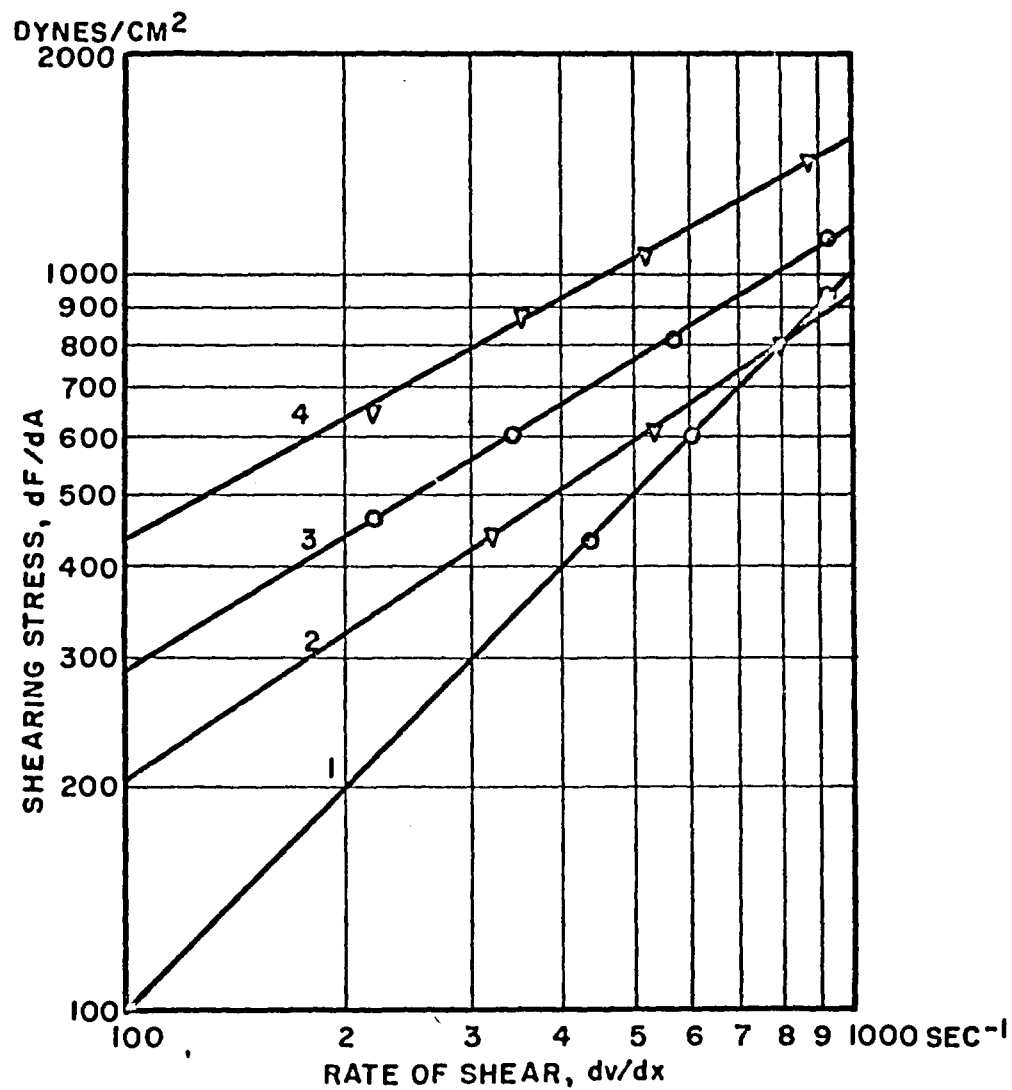

FIG.12 - FLOW CURVES FOR GALENA AND GLASS SUSPENSIONS.

TABLE 5

Viscosity Results of Galena and Glass Bead Mixtures

Dispersion medium: glycerine-water mixture
 sp gr = 1.21
 η = 27.5 cp at 88°F

Force up (dynes)	Force down (dynes)	Total Force (dynes)	dF/dA (dynes cm ²)	t _{avg} (sec/60)	dv/dx (sec ⁻¹)
1) <u>70% Dispersion Medium, 30% Glass Beads. Temp. 88°F; sp gr 1.53</u>					
6770	1730	5040	438	91	441
7830	1730	6100	602	67	600
(free fall)			921		930
2) <u>70% Dispersion Medium, 7 1/2% PbS, 22 1/2% Glass Beads. Temp. 88°F; sp gr 1.83</u>					
6770	1655	5115	440	126	319
7830	1655	6175	614	75	536
9060	1655	7405	804	50	800
3) <u>70% Dispersion Medium, 15% PbS, 15% Glass Beads. Temp. 88°F; sp gr 2.12</u>					
6770	1580	5190	462	182	220
7830	1580	6250	626	117	343
9060	1580	7480	816	71	565
11022	1580	9442	1120	43	934
4) <u>70% Dispersion Medium, 30% PbS. Temp. 87°F; sp gr 2.71</u>					
7830	1430	6400	649	175	229
9223	1430	7793	864	115	349
10453	1430	9023	1054	78	515
12735	1430	11305	1408	46	874

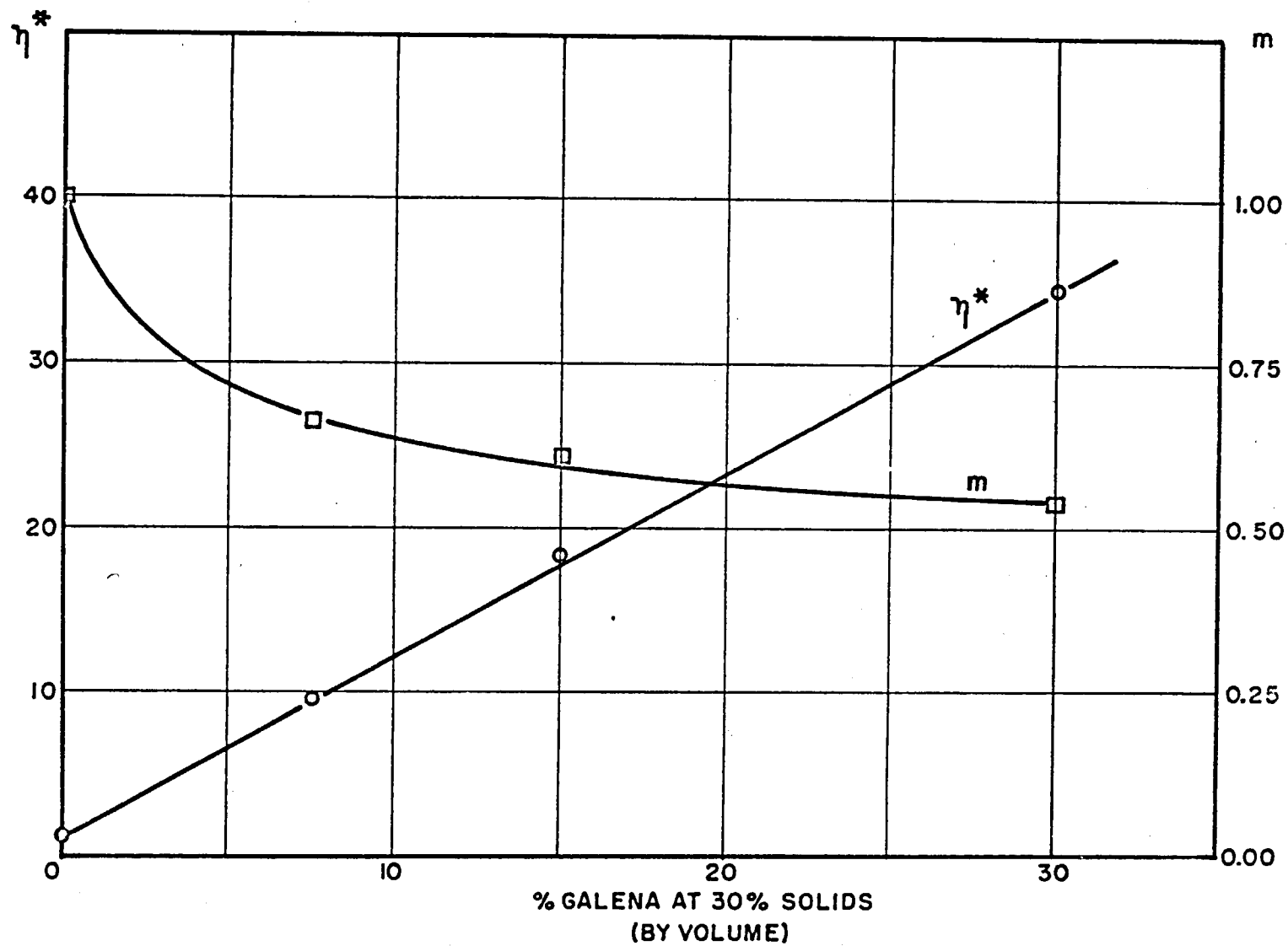

FIG. 13-VARIATION OF η^* AND m WITH GALENA CONCENTRATION.

A comparison of results for suspensions of various materials at 45% solids by volume is shown in Figure 14. Barite, although it is the finest of the materials, has a low apparent viscosity, probably because of the near-spherical shape of its particles and the resultant large mean free path between particles. Galena, which is coarser and has cubic particles, has a comparable viscosity but a distinctly more non-Newtonian flow curve. This great departure from Newtonian behaviour is thought to be due to the flat surfaces of the galena particles. The suspension of glass spheres exhibits Newtonian behaviour and a very low viscosity. Photomicrographs of particles of the solids used (Figure 15) indicate the respective particle shapes. Size analyses are given in Table 6.

Barite and galena both have good cleavage in three directions. As a result, the particles of these materials are equiaxed, and the mean free path between particles is large. It is expected that suspensions of other minerals (quartz, pyrite, etc.) of comparable size analysis generally will possess higher apparent viscosities at comparable volume concentrations, due to lesser mean free paths. Preliminary tests on a uranium ore slurry (60%-200 mesh) bear this out.

CONCLUSIONS

The slurry viscometer, as it stands, is capable of measuring viscosities from 100 to 500 centipoises at rates of shear of from 100 to 1000 reciprocal seconds. This range could be extended by the use of different sizes of spheres, and by decreasing the pulley friction by the use of jewelled bearings. Electric timing of the external weight would simplify the apparatus considerably.

A comparison of results for suspensions of various materials at 45% solids by volume is shown in Figure 14. Barite, although it is the finest of the materials, has a low apparent viscosity, probably because of the near-spherical shape of its particles and the resultant large mean free path between particles. Galena, which is coarser and has cubic particles, has a comparable viscosity but a distinctly more non-Newtonian flow curve. This great departure from Newtonian behaviour is thought to be due to the flat surfaces of the galena particles. The suspension of glass spheres exhibits Newtonian behaviour and a very low viscosity. Photomicrographs of particles of the solids used (Figure 15) indicate the respective particle shapes. Size analyses are given in Table 6.

Barite and galena both have good cleavage in three directions. As a result, the particles of these materials are equiaxed, and the mean free path between particles is large. It is expected that suspensions of other minerals (quartz, pyrite, etc.) of comparable size analysis generally will possess higher apparent viscosities at comparable volume concentrations, due to lesser mean free paths. Preliminary tests on a uranium ore slurry (60%-200 mesh) bear this out.

CONCLUSIONS

The slurry viscometer, as it stands, is capable of measuring viscosities from 100 to 500 centipoises at rates of shear of from 100 to 1000 reciprocal seconds. This range could be extended by the use of different sizes of spheres, and by decreasing the pulley friction by the use of jewelled bearings. Electric timing of the external weight would simplify the apparatus considerably.

DYNES/CM.²

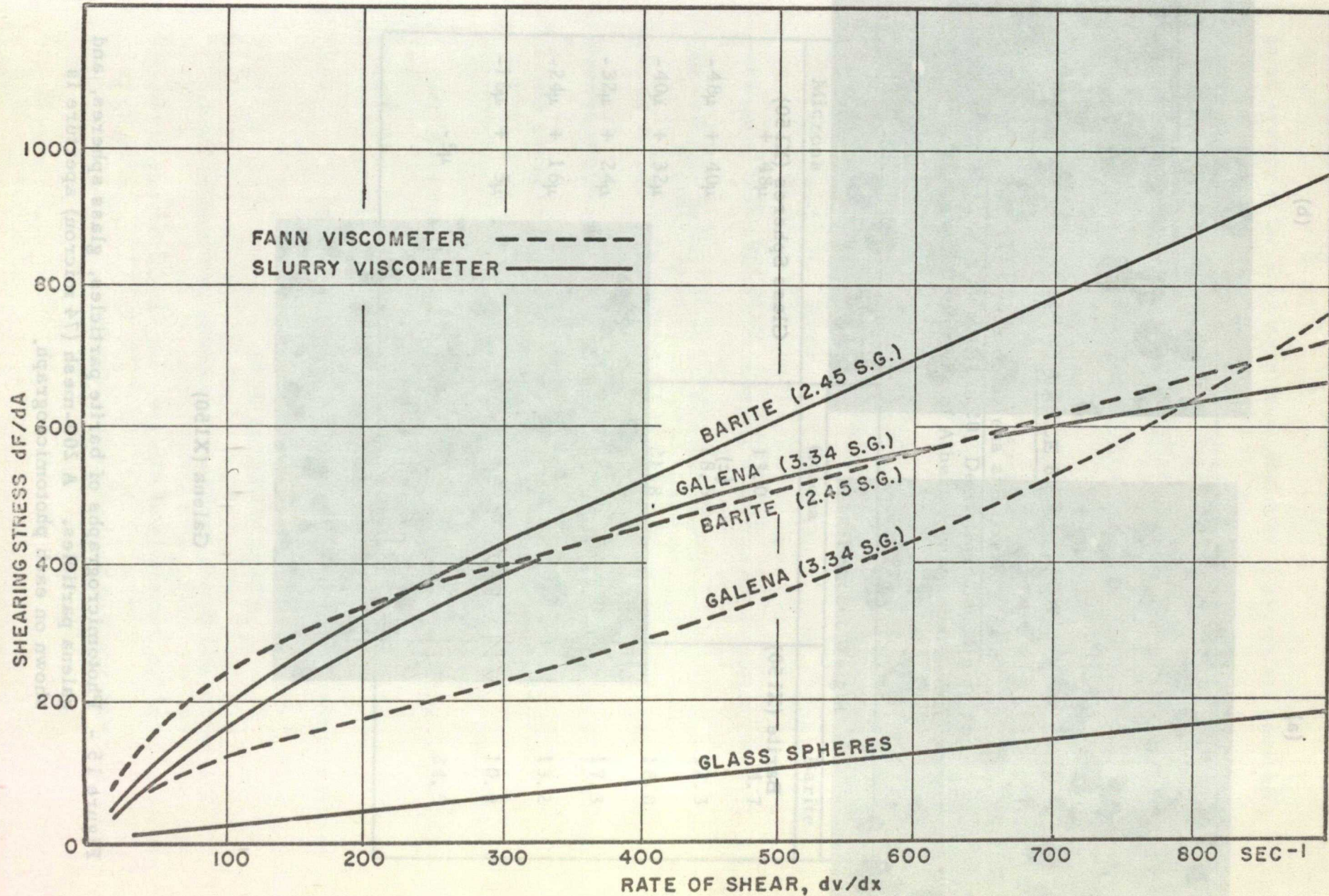

FIG. 14- FLOW CURVES FOR VARIOUS SUSPENSIONS AT 45% SOLIDS (BY VOLUME)

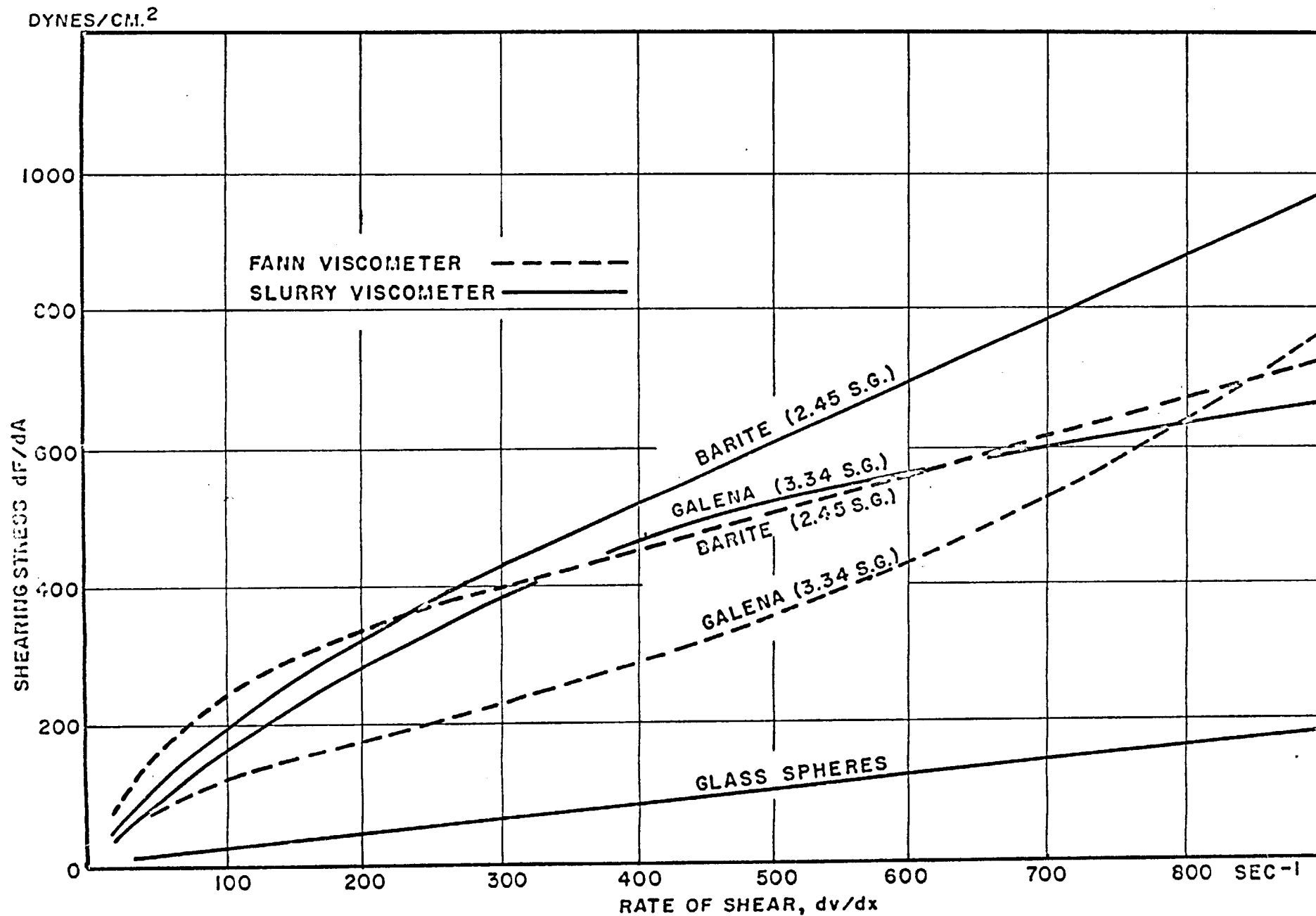
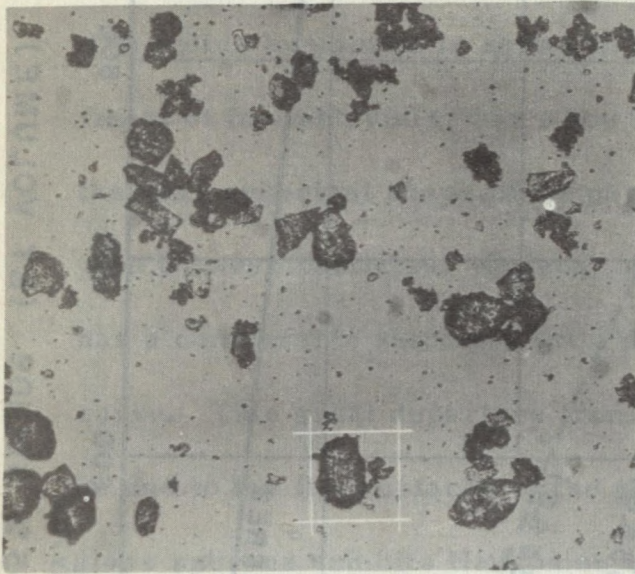

FIG. 14 - FLOW CURVES FOR VARIOUS SUSPENSIONS AT 45% SOLIDS (BY VOLUME)

(a)



Barite (X150)

(b)

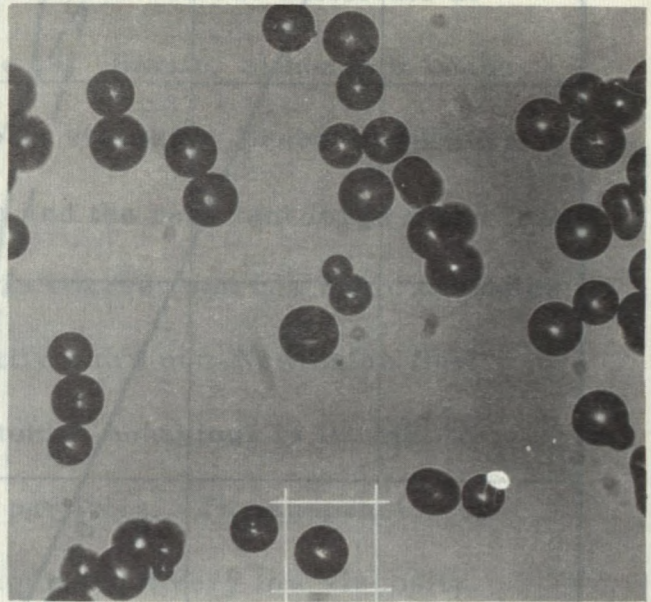

Glass Spheres (X150)

(c)

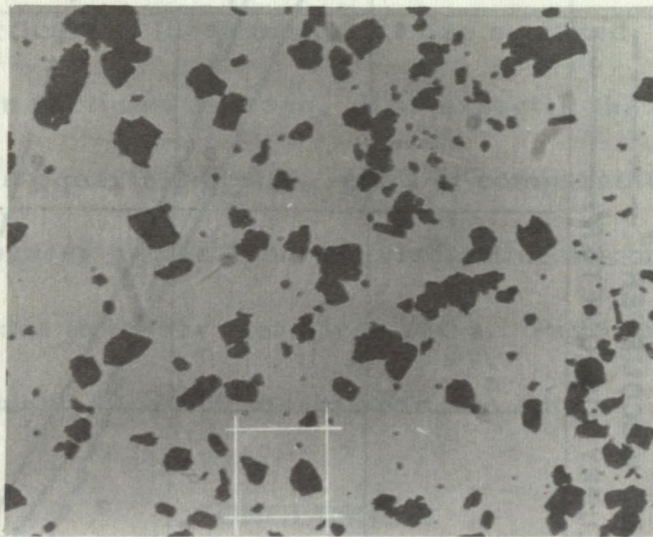

Galena (X150)

Figure 15 - Photomicrographs of barite particles, glass spheres, and galena particles. A 200-mesh (74 micron) aperture is shown on each photomicrograph.

TABLE 6

Size Analyses of Galena and Barite Media
 (From Progress Report No. 20, Department of Mining and
 Metallurgy, University of Alberta, November, 1957)

Size Microns	Percent Weight	
	Galena	Barite
+ 48 μ	13.0	4.7
-48 μ + 40 μ	18.5	12.3
-40 μ + 32 μ	21.8	18.0
-32 μ + 24 μ	17.7	17.3
-24 μ + 16 μ	8.4	13.2
-16 μ + 5 μ	6.6	10.0
-5 μ	14.0	24.5

Because the stress is constant, and fresh material is always being sheared through any one measurement, this viscometer is well suited to the determination of the rheological properties of thixotropic fluids.

Suspensions having initial settling rates of less than 1 mm/min are most conveniently handled in this apparatus, although suspensions having much higher settling rates can be satisfactorily tested. When dealing with suspensions that settle rapidly, the testing procedure must be carried out quickly, and check readings should be taken before the results are accepted, since the solids tend to become compacted at the ends of the tube.

An estimation of the accuracy of which this instrument is capable may be obtained from a consideration of its performance with Newtonian fluids (Table 1). The maximum percentage error is $\pm 4\%$. A similar deviation is expected when the viscometer is used for stable suspensions.

Since no absolute knowledge of the velocity distribution for non-Newtonians exists at present (see Appendix), results obtained with this viscometer should be considered in a relative light. However, the results should be applicable to the design of slurry transport systems, the flow in the annulus being similar to flow in a pipeline.

ACKNOWLEDGMENTS

The barite and galena samples were kindly provided by Prof. E.O. Lilge of the University of Alberta. Mr. R.G. Draper of the Fuels Division supplied the calibration samples.

REFERENCES

1. Lilge, E.O., Fregren, T.E., and Purdy, G.R., "Apparent Viscosities of Heavy Media and the Driessen Cone". Trans. Inst. Min. Metall. (London), 67, 229 (1957-1958).
2. Scott-Blair, W., "A Survey of General and Applied Rheology". Pitman, London (1944).
3. Barr, G.A., "A Monograph on Viscometry". Oxford University Press (1931).
4. Schlichting, H., "Boundary Layer Theory". McGraw-Hill Book Company, Inc., New York (1955).
5. Govier, G.W., Shook, C.A., and Lilge, E.O., "The Rheological Behaviour of Magnetite, Galena and Ferrosilicon Media". Trans. C.I.M.M. 60, 147 (1957).
6. Ostwald, W. and Auerbach, R., "Viscosity of Colloidal Solutions in the Structural, Laminar, and Turbulence Regions". Kolloid Z. 38, 261-280 (1926).

- - -

GRP:GGE:ew

APPENDIX

Estimation of Flow Distribution in Annulus
for Non-Newtonian Fluids

Considering a small segment of the annulus with unit average width

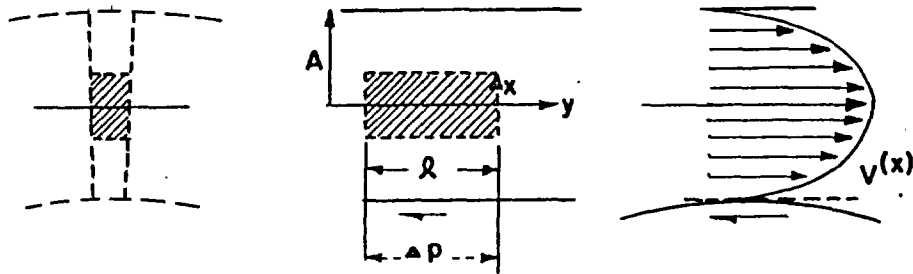

$$\text{Pressure Force} = 2x \Delta p$$

$$\text{Shear Force} = 2\ell \frac{dF}{dA}$$

$$\text{At Equilibrium, } 2x \Delta p = 2\ell \frac{dF}{dA}$$

$$\therefore \frac{dF}{dA} = \frac{x \Delta p}{\ell}$$

For a Newtonian Fluid:

$$\frac{dF}{dA} = \frac{x \Delta p}{\ell} = -\eta \frac{dv}{dx}$$

$$\frac{dv}{dx} = -\frac{x \Delta p}{\eta \ell}$$

$$v(x) = -\left(\frac{\Delta p}{2\eta \ell}\right)(x^2 + c);$$

when $v(x) = 0$, $x = A$

$$\therefore v(x) = -\left(\frac{\Delta p}{2\eta \ell}\right)(x^2 - A^2).$$

∴ The velocity distribution is parabolic.

(Appendix, concluded)

For a Non-Newtonian Fluid:

Assuming that the rheological behaviour can be described in terms of equation 7) (page 25):

$$\frac{dF}{dA} = \frac{x \Delta p}{\ell} = -\eta^* \left(\frac{dv}{dx} \right)^{\frac{1}{n}}$$

where $\frac{1}{n}$ is substituted for m .

$$\frac{dv}{dx} = \left(-\frac{x \Delta p}{\eta^* \ell} \right)^n$$

$$v(x) = \left(-\frac{\Delta p}{\eta^* \ell} \right)^n \cdot \left[\frac{x^{n+1}}{n+1} + C \right];$$

when $v(x) = 0$, $x = A$

$$\therefore v(x) = \left(-\frac{\Delta p}{\eta^* \ell} \right)^n \cdot \left[\frac{x^{n+1} - A^{n+1}}{n+1} \right].$$

For galena and barite, approximate values for $1/n$ are 0.6 and 0.75 respectively.

$$\therefore \text{For galena} \quad v(x) \approx k x^{2/3},$$

$$\text{and for barite} \quad v(x) \approx k x^{7/3}.$$

In both cases the velocity distribution is not parabolic, and the factor K depends on the non-Newtonian character of the fluid as well as the dimensions of the viscometer.
