

# Canoma

Vol. 24 No./No 1  
July / juillet 1998

Comité permanent canadien des noms géographiques



- 1 A short appreciation of "Scotch"  
*Philip Goldring*

- 6 Ontario Toponymic Database  
*Jeffrey R. Ball*



- 7 The Canadian Geographical Names Data Base (CGNDB)  
La Base de données toponymiques du Canada (BDTC)  
*Peter Revie and/et Helen Kerfoot*

- 16 TOPOS : La banque de données toponymiques - mise à jour de l'information  
TOPOS: Toponymic data bank - information update  
*Alain Vallières and/et Benoît Boisvert*

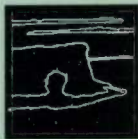

- 19 Nova Scotia Geographic Names Data Base  
*Keith AuCoin and David Wills*

- 20 Alberta's Geographical Names Inventory Database  
*Merrily Aubrey*

- 20 Publications of interest / Publications d'intérêt



- 21 Geographical Names Data Base (MGNDB)  
*Gerald F. Holm*

- 23 Some meetings concerning names / Quelques réunions sur les noms

- 24 Ontario post office locations  
*Robert C. Smith*



- 25 Recent municipal changes in Canada  
Changements municipaux récents au Canada  
*Kathleen O'Brien*



- 36 New Brunswick data base / Base de données du Nouveau-Brunswick

Communications concerning *Canoma* or geographical names in general should be sent to:

Secretariat  
Canadian Permanent Committee on  
Geographical Names  
6th Floor, 615 Booth Street  
Ottawa, Ontario, K1A 0E9  
Fax (613) 943-8282

If you would like a copy of any article in the other official language, please contact the Secretariat.

Toute information concernant *Canoma* ou les noms géographiques en général devrait être envoyée au :

Secrétariat  
Comité permanent canadien des noms  
géographiques  
6<sup>e</sup> étage, 615, rue Booth  
Ottawa (Ontario) K1A 0E9  
Télec. : (613) 943-8282

Si vous désirez recevoir le texte d'un article dans l'autre langue officielle, veuillez contacter le Secrétariat.

Editing, compilation, and layout / Rédaction, compilation et disposition typographique :

Kathleen O'Brien  
Anne Nederlof  
Jocelyne Revie  
Heather Ross

Design / Conception et modèle  
Kostron Graphics

©Minister of Supply and Services  
Canada 1998

Catalogue No. M85-12/24-1  
ISSN 0319-5228

©Ministre des Approvisionnements et  
Services Canada 1998

N° de catalogue M85-12/24-1  
ISSN 0319-5228

# A short appreciation of "Scotch"

Philip Goldring<sup>1</sup>

## Wandering along the old Scotch Line

Fifty miles west of Ottawa, on the edge of the town of Perth, a paved road known locally as the Scotch Line branches at right angles off the main southbound road. For the first 17 kilometres this road follows a straight line, almost to the point where the rough granite country of the Frontenac Axis comes down to meet the great plain of the Ottawa Valley. Here the paved road (County Road 10) climbs into the Canadian Shield on its way to Westport and Kingston, while the Scotch Line renamed the Upper Scotch Line, plunges straight ahead for six kilometres before the row of solid Victorian farmhouses soon wavers and fades into the bush.

Where Country Road 10 veers into the hills is a point, not so much a village as the middle of an extended farming community, which bears the official name of **Scotch Line**; it is gazetted as an "unincorporated area". Quite plain in its origins and its appearance today, the Scotch Line settlement is older than Canada's capital, and has embedded in it a curious piece of Canadian toponymic history.

Scotch Line is one of the oldest place names in continuous usage in this part of Eastern Ontario. Its form reveals this — since the end of the 19th century the word "Scotch" has gradually lost ground to its alternative forms "Scottish" and "Scots". It might still surprise some readers, though, to learn that the word has recently been denounced as not merely old-fashioned but derogatory. According to the newest edition of the *Gage Canadian Dictionary*, "Scotch, except in reference to whisky, is considered derogatory although it is used adjectivally in set phrases like Scotch egg and Scotch pine."<sup>2</sup>



Fig. 1. Modern township road signs can be a source of local history. (Source: P. Goldring)

The history of this word is under-appreciated. Many Canadians learned as children that "Scotch" refers to whisky, and that the country and the people are best referred to as "Scottish". In this, as in many other matters, we can learn by observation that children are rarely told the whole truth! A year's residence in Scotland in the 1970s brought home to me some unavoidable exceptions to this rule. First, the word "Scotch" continued to be used, especially in shop windows, to refer to anything that was grown or produced in Scotland;

"Scotch whisky" and "Scotch tweeds" were all very well, but what about such New World imports as "Scotch potatoes" and even "Scotch tomatoes"? Why were these not labeled "Scottish", "local", or even "home-grown"? Second, "Scotch" as a noun meaning "whisky" is an unusual usage in Scotland, an occasional acknowledgement that the great bulk of this valuable commodity is sold to foreigners, who need a word to distinguish it from inferior imitators. In Scotland, Scotch whisky is, naturally enough, referred to as "whisky".

Other whiskies are known to exist — notably Japanese whisky, a rival in an important market — but in local usage "whisky" unmistakably means the local article. Calling this eminently drinkable product by the exonym "Scotch" is the mark of an outsider (or at least an exporter). Third, the adjective "Scots" survives in more contexts than the lexicographers suppose. Until recently it retained a fusty legalistic flavour, redolent of old weights and measures, laws and currencies that predated the Act of Union of 1707; as an adjective, "Scots" seems to be rebounding, especially among headline-writers, for it is three letters shorter than its main rival,





"Scottish". This trend is likely to accelerate with the re-structuring of the Union which is to come in the next few years.

The decline of the word "Scotch" on both sides of the Atlantic is an interesting shift. Instead of the dictionaries gradually catching up with spoken and written usage, usage has fallen into line with what the dictionaries have preached all along. The lexicographers are winning a battle against everyday usage. Perhaps this has happened because the term falls into that delicate area of names that refer to national or ethnic origins. A striking aspect, however, is that in Canada the word "Scotch", as noun and adjective, was a cherished description used by Scottish people in reference to themselves and their special places. Toponyms like Scotch Line, once examples of everyday speech, are now standing out as islands of archaic usage in a flat sea of cultural caution.

Among the approved names in the Canadian Geographical Names Data Base, there are 68 "Scotch" names, only 20 that incorporate the word "Scots", and a single appearance — *Scottish Lake* in British Columbia — of the preferred adjectival form of the word.<sup>3</sup> These usages suggest a little of where we are, and where we have come from, in the way we apply names that reflect national origin to the geographical features and settled places around us.

This short essay, a distillation of a few hours research and reflection, is written to share a conviction that Canada's "Scotch" toponymy is certainly a little archaic, but is something to imbibe and savour, and never to denounce or rescind.

### Scottish geographical names in Canada

The Scottish roots of Canadian toponymy run very deep; even one of our provinces is, not by accident, named "New Scotland". In the 1960s, Watson

Kirkconnell of Acadia University undertook a study of "Scottish Place-Names in Canada" which he published in 1970. Working initially from Scottish road atlases and 13 700 names in the *Canada Official Postal Guide*, and broadening his search to include G.F. Black's *The Surnames of Scotland*, Kirkconnell estimated that 1200 of Canada's settled places — slightly under ten per cent — were named after Scots or places in Scotland. Kirkconnell, of course had no Canadian Geographical Names Data Base to tap into, so could not be expected to explore the naming of geographical features in addition to settled places. The numbers, especially of family names, are enormous. In the data base, the surname MacDonald (including McDonald) appears 356 times, chiefly in connection with small bodies of water. But the MacDonalds are a large clan, found in considerable concentrations in many of the old counties of Scotland. More remarkable, in a way, is that the old Skye and inner Hebridean local surname MacKinnon also occurs (with variants) some 79 times in the data base.

The origins of these naming patterns lie, of course, for the most part with the people who settled the country, and to a lesser extent with those who mapped it. In his brief, light memoir entitled *The Scotch*, John Kenneth Galbraith made a memorable

comment about his own rural southwest Ontario ancestors and their impact on local toponymy:

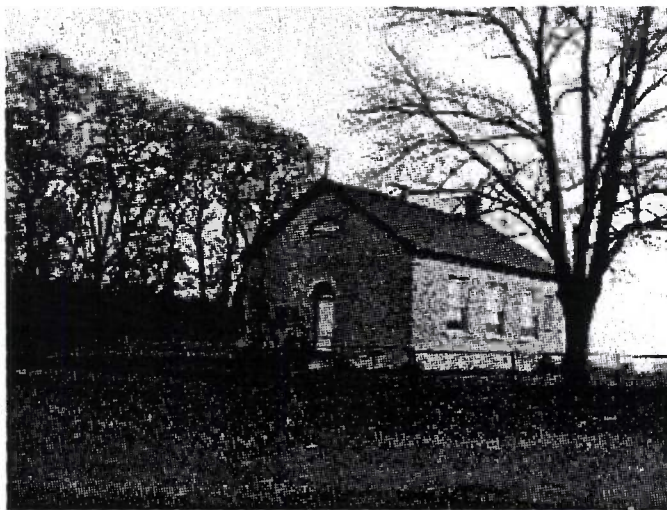

Fig. 2. The old Prebyterian church on the Upper Scotch Line, Lanark County, Ontario. (Source: P. Goldring)

*The English guided the larger political life of the community so the larger political subdivisions had English names or commemorated Scottish aristocrats. Elgin County was for James Bruce, 8th Earl of Elgin and 12th*

*Earl of Kincardine, Governor-General of Canada 1846-1854. Aldborough, Dunwich, Southwold and Yarmouth townships were after their English namesakes. But the Scotch had their way with the micro-economic places — Iona, Wallacetown, Cambellton, Fingal, Crinan, Glencoe, Port Bruce, Cowal.<sup>6</sup>*

The same is generally true of Prince Edward Island; there is a strong Scottish element in the island's population, but before they arrived much of the toponymy had been fixed in place by the predominantly English landowners.

Many of the "Scotch" and "Scots" names appear in areas of ethnically mixed settlement, where pockets of Scottish settlement needed to be identified where they rubbed shoulders with other origins. Other toponymic influences abound. **Scotch Bonnet Island** (several examples in Ontario) and **Mont Scotch Cap** in Quebec likely refer to the shape or appearance of a geographical feature. So, probably, does the Nova Scotia waterfall **Scotchmans**

**Lip**. (It is not pleasant to imagine the stream of water that trickles over the edge of this feature.) **Scotch Fir Point** (British Columbia) is a botanical reference, and so is **Scotch Thistle Point** (Ontario). **Mount Scotch Tom** (Northwest Territories) likely has a different story; "Scotch Tom" would almost certainly have been not a Scotsman but an Inuk, one of many in the eastern Arctic who hired on with the 19th-century Scottish whaling captains. Since the whalers' nickname "Scotch Tom" distinguished him from any Inuk nicknamed "Tom" working for American whalers at the time, the connection to Scotland is maybe not as distant as it seems at first glance; and a number of the Inuit whaling specialists did visit Scotland in the years when the vessels made predictable annual voyages.

These exceptions aside, the steady list of features named **Scotch Lake**, **Scotch Corners**, **Scotch Hill** and even **Scotch Bush** are reminders of the first decades of Scottish settlement in the localities where these names are found. The word "Scotch" is found in 24 place names and 44 feature names spread across every province and territory except Alberta and Saskatchewan.

The 20 occurrences of the form "Scots", sometimes alone but often in fanciful combinations like **Scotsburn** (Nova Scotia)

and **Scotsguard** (Saskatchewan) are also divided between geographical features (12) and settled places (8) which are mainly small Quebec's **Marécage des Scots** is an interesting name, while British Columbia's **Mount Scotsimpson** also provokes curiosity. Yukon, New Brunswick, and Prince Edward Island do not have toponyms using the "Scots-" form.

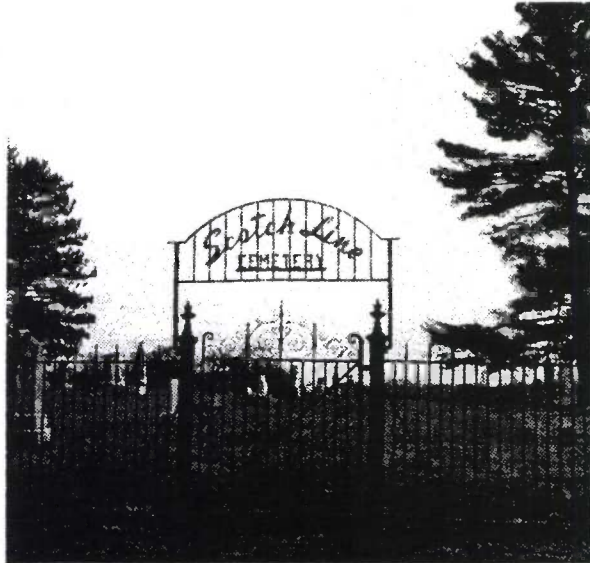

Fig. 3. Entrance to the Scotch Line Cemetery.  
(Source: P. Goldring)

### When did "Scotch" fall out of favour?

These patterns, with the tendency of "Scotch" to predominate in the longer-settled eastern parts of the country, draws attention back to the question of the use of the word "Scotch" by Canadians of Scottish ancestry to describe themselves and the things that were dear to them. The published

Presbyterian sermon literature of the 19th century shows a tendency to self-identify as "Scotch"; Canadian printers published sermons from the "Scotch Presbyterian Church (at) Quebec" in 1804, from the "Saint Gabriel Street Scotch Church" in 1857, from the "National Scotch Church, Saint Matthew's Halifax" in 1866, and from a sprinkling of others: Beauharnois in 1845, Quebec 1814, a second "Scotch Presbyterian Church" in Montréal (St. Peters Street, 1835), Bayfield and Varna in Huron Co., Ontario (1879), and "St. Andrew's Scotch National Church, Halifax" in 1875.<sup>7</sup> If there was a distinction between Highland and Lowland use of the word Scotch it is not apparent from this sermon literature.

This venerable word has travelled a long way from respectability into near-obscurity, and fashion alone can hardly explain it — the word has followed a downward trajectory we associate with the derogatory ethnic and national labels that outsiders apply; yet among Scots, and in particular eastern Canadian Scots up to about the First World War, "Scotch" had not merely neutral but positive resonances. Its near-disappearance, and the recent denunciation in *Gage's Canadian Dictionary*, are not simply an example of the way society periodically re-labels the groups it has oppressed or disparaged. Scots in Canada have rarely been a disadvantaged group, and the term "Scotch" seems





to have been abandoned impartially by Scots and non-Scots alike.

The suggestions that follow are more than personal observation and hunch, and less than a full semantic and socio-linguistic inquiry.

The word "Scotch" in Canada in the 19th century had almost entirely positive connotations; it was used by the people it described to distinguish some of their most cherished collective institutions and identity. It was in the vocabulary of Burns and Scott, but the language of Burns was changing. By the turn of the century, the great (English) dictionaries were expressing caution, asserting that Scotch was an English exonym and that "Scottish" was preferred in Scotland.

The explanation given in the *Oxford English Dictionary* in 1914 may still be found in the *Oxford Reference Dictionary* of 1986, and likewise appears almost verbatim in the 1965 edition of H.W. Fowler's *Modern English Usage: Out of deference to the Scotsman's supposed dislike of Scotch, that word has been falling into disuse in England also*.<sup>8</sup> A century ago, however, Scots in Canada showed no such dislike; Scottish-Canadian newspapers and Scottish-Canadian novelists used the word freely. Ralph Connor's celebrated *Man from Glengarry* refers, in its very first sentence, to a fictitious Scotch Creek in the northwest corner of what was then the most Scottish of Canadian counties. The rapid disappearance of "Scotch" in our own century can

be blamed -- at least tentatively -- on a form of linguistic colonialism practiced by immigrant Englishmen, or (perhaps more likely) by fastidious immigrant Scots.

### Why a derogatory word?

It may be all very well for English lexicographers and Scots generally to denounce "Scotch" as, in origin, an English coinage and therefore inferior to

the more domestic "Scots" and "Scottish". But it is a long step from there to the allegation that "Scotch" in Canada is not just obsolete but derogatory. The explanation is still obscure to this writer, but one can be suggested. Although Scots are rarely portrayed as a disadvantaged minority in Canada, there are elements of ethnic stereotyping that surround their nationality, in either its Highland or Lowland form. Sometimes they indulge in it themselves. The standard geography of the world which was authorised for many years for use in Nova Scotia schools had this to say in 1892: *The Scotch are industrious, brave, and intelligent. Many emigrate to the British colonies and the United States, where they usually acquire a large share of prosperity*.<sup>9</sup>

A certain affinity between Scots and money can be noted elsewhere in the literature. John Kenneth Galbraith, no mean economist himself, had a word on the subject relating to an Elgin County neighbour known as Codfish John. (Codfish, though somewhat repulsive as a steady diet, offered the cheapest form of protein for large families.) *Interestingly, it was always said of Codfish John, as of anyone else who was excessively frugal, that he was "very Scotch"*.<sup>10</sup>

A collection of anecdotes like these can feed an ethnic stereotype; and a virtue carried to extremes can sometimes seem a vice. If "Scotch" is truly a derogatory word, excessive frugality is the heaviest piece of embarrassing baggage it carries.

### A future for Scotch?

In Canada, well past the middle of the present century, a number of hardy individuals, including distinguished men of letters, held out against the tide. John Kenneth Galbraith, though no longer a Canadian, certainly kept up the good old name, though the London edition of his book was tellingly retitled *The non-potable Scotch*.<sup>11</sup> Much more noteworthy is Hugh MacLennan; he acquired from the Cape Breton doctor who was his father a contempt for newfangled terms of self-identification: *he was neither a Scot nor yet was he*



Fig. 4. Farmland cleared by settlers on the Scotch Line shortly after the War of 1812. (Source: P. Goldring)

*Scottish; he never used those genteel appellations which now are supposed to be de rigueur. He was simply Scotch.*<sup>12</sup> And not only was MacLennan himself not Scottish, he was a Scotchman. In his essays, Sir John A. Macdonald was also a Scotchman. The politer terms were to be scoffed at. And yet, along with a lack of pretentiousness, along with a fondness or one of his father's crotchets we can read a kind of swagger in MacLennan's use of "Scotch". He advertised not just a love of the plain old words, but a confidence in his own stature as a writer who could break the rules. He could still flaunt the old homespun terms even if he was a well-known man of letters in the city — or perhaps *because* he was a well-known man of letters.

The fate of this distinguished word is not hard to guess: it will fade even further into obscurity. This brief account, based more on personal observation than on profound research, may provoke interested readers to a more learned exploration of the subject — that will not bring back into vogue a style that was perfectly natural and acceptable to Scottish Canadians less than a century ago. In the foreseeable future the preservation of Scotch in Canada — in other than its bottled form — likely depends on toponymy. Rugged places such as Scotch Line are likely up to the task.

### Endnotes

- 1 Philip Goldring, Parks Canada, Hull, Quebec.
  - 2 Gage Canadian Publishing Company (1977): *Gage Canadian Dictionary*, Toronto Gage Canadian Publishing Company), p. 1311. By contrast, the Canadian Oxford Dictionary (Oxford University Press, 1998, p. 1297) says that *The use of the Scotch as an alternative to Scottish or Scots is generally regarded as offensive or old-fashioned by Scottish people. It should be avoided...* with the usual exceptions. Similarly, the ITP Nelson Canadian dictionary of the English language (Scarborough, ITP Nelson, 1997, p. 1228) says that ... *in the interests of civility, forms involving Scotch are best avoided in reference to people. But there is no sure rule for referring to things...*
  - 3 Despite the slow extension of the adjective "Scots" and the near-disappearance of "Scotch", the form "Scottish" which is recommended by all good English dictionaries is very much the dominant form.
  - 4 There are 70 CGNDB records with the form
- 5 Watson Kirkconnell (1970): *Onomastica No. 39*, "Scottish Place-Names in Canada", Winnipeg and Canadian Institute of Onomastic Sciences and Ukrainian Free Academy of Sciences, Wolfville.
  - 6 John Kenneth Galbraith (1964): *The Scotch* Macmillan Company of Canada, Toronto, p. 7.
  - 7 A search of the National Library's on-line catalogue, "Resanet", produced these among many other occurrences of the word "Scotch". There were a number of other occurrences in eastern Canada in the 19th century, as well as 20th-century historical works on "Scotch" congregations or cemeteries. The list is limited to places named in book titles.
  - 8 H.W. Fowler (1965): *A Dictionary of Modern English Usage*, Oxford University Press, Oxford, (Second edition, rev. by Sir Ernest Gowers), pp. 540-541.
  - 9 J.B. Calkin, MA, (1892): *School Geography of the World*, T. Nelson and Sons, London, and A. and W. Mackinlay, Halifax, p. 95. Calkin is identified as principal of the provincial Normal School at Truro, and the book was "Prescribed by the Council of Public Education for use in the Public Schools".
  - 10 Galbraith, *The Scotch*, p. 30.
  - 11 J.K. Galbraith (1967): *The non-potable Scotch: a memoir on the clansmen in Canada*, Penguins, Harmondsworth, England.
  - 12 Hugh MacLennan (1960): *The Scotchman's Return, and other Essays*, Toronto, MacMillan.

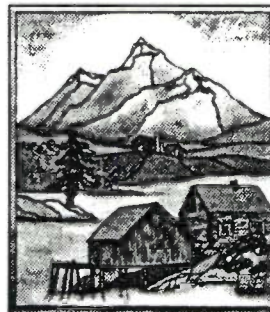

# Ontario Toponymic Database

Jeffrey R. Ball<sup>1</sup>

## Contents

The Ontario Toponymic Database contains information relating to a comprehensive set of official names of geographical features and populated places found in the province. Digital data sets maintained are largely fashioned on the national standard. Deviations from the Federal system or significant additions include:

- normalized handling of name and name key field information with names listed and sorted in the form approved, i.e., Lake Ontario - not Ontario, Lake;
- additions of UTM coordinates and provincial map references to comply with provincial georeferencing standards;
- French-text Equivalent cross-references to official name forms for prose text applications;
- digital graphic extent files for all new name approvals, where digital data sets exist.

In total, there are approximately 80 000 toponyms maintained in Ontario, including 57 000 having official status.

## Technical environment

Ontario's is a stand-alone system running on a Pentium PC platform using ORACLE (7.3), ARCVIEW (3.0 patch), and Windows 95 software.

## Data collection and updating

Normally, data collection is reactive. Discrepancies and requests for new names are incorporated as they are identified or requested. Presently, funds have been allocated to concentrate on updating all official records to nearest second accuracy.

## User groups

Copies of the core official name and coordinate references are used by many applications within the Ontario Ministry of Natural Resources and the provincial government.

External users include all levels of government, members of the mapping industry, researchers, publishers, geologists, ecologists, biologists, and conservationists. Access to the information is in keeping with the *CPCGN Members' agreement on geographical names data availability and distribution*, and is granted after a request has been submitted to the Ontario Ministry of Natural Resources.

## Endnote

1. Jeffrey R. Ball, Geographic Names Data Specialist, Ontario Ministry of Natural Resources, Peterborough.

## Quotes from the Geographic Board of Canada's minutes

### 25 April 1916 - Name origins

... and that the Board makes a point of keeping record of circumstances of origin of names it deals with, so that these cannot be lost sight of.

### 3 December 1953 - Item D

... The Board decided that its present stand on not naming features for surveyors, civil servants or others in an area, in the normal course of their work should be maintained ... (File 2922)



# The Canadian Geographical Names Data Base (CGNDB)<sup>1</sup>

## La Base de données toponymiques du Canada (BDTC)<sup>1</sup>

Peter Revie and / et Helen Kerfoot<sup>2</sup>

**Abstract:** *The Canadian Geographical Names Data Base (CGNDB) contains some 500 000 records, over two-thirds of which are currently official names, as approved by the Canadian Permanent Committee on Geographical Names (CPCGN). This data base of names of places and geographical features is managed with ORACLE software on a SOLARIS operating system maintained by Natural Resources Canada. It is the fundamental national data base to provide official names for mapping and charting, gazetteer production, and World Wide Web reference, and other geo-referenced digital systems. Over 30 attributes may at present be stored for any name, and the data base is updated on a daily basis.*

**Résumé :** *La base de données toponymiques du Canada (BDTC) contient quelques 500 000 entrées, dont plus des deux tiers se rapportent à des toponymes (noms de lieux et d'entités géographiques) officiels et approuvés par le Comité permanent canadien des noms géographiques (CPCNG). Cette base de données est gérée par le logiciel ORACLE sous un système d'exploitation SOLARIS exploité par Ressources naturelles Canada. C'est la principale source d'information nationale à consulter pour connaître les appellations officielles aux fins de l'élaboration des cartes, de la production des répertoires toponymiques, de la navigation sur le Web et de l'utilisation des autres systèmes numériques à référence spatiale. Capable de contenir plus de 30 attributs pour un même nom, la base de données est mise à jour quotidiennement.*

### Introduction

The Canadian Geographical Names Data Base (CGNDB) is the data bank of Canada's geographical names, maintained by the Geographical Names Section, part of the Centre for Topographic Information, Geomatics Canada, Natural Resources Canada. Its purpose is to store names that have been approved by the Canadian Permanent Committee on Geographical Names (CPCGN) and to make these authoritative records available for government and public use.

The naming of geographical features in Canada is today the responsibility of each province and territory, except where federal lands, such as Indian reserves or national parks, are concerned. Details of the decisions to adopt, change, or reject geographical names are sent to the CPCGN Secretariat to maintain the national registry. All such names records are entered into the CGNDB, and the office copies of the National Topographic System (NTS) maps are amended to reflect these name decisions.

The forerunner of the CGNDB (the National

### Introduction

La Base de données toponymiques du Canada (BDTC) est la banque de données des noms géographiques qui fait autorité au Canada. Elle est gérée par la Section des noms géographiques du Centre d'information topographique, à Géomatique Canada, Ressources naturelles Canada. Elle vise à emmagasiner les noms qui ont été approuvés par le Comité permanent canadien des noms géographiques (CPCNG) et à diffuser ces données qui font autorité aux utilisateurs du gouvernement et du public.

La désignation des entités géographiques du Canada relève maintenant de la compétence de chaque province et territoire, sauf lorsque les entités se trouvent sur des terres fédérales, comme des réserves indiennes et des parcs nationaux. Les renseignements relatifs aux toponymes adoptés, modifiés ou annulés sont communiqués au Secrétariat du CPCNG, qui adapte la BDTC et les copies de travail des cartes du Système national de référence cartographique (SNRC) en fonction des décisions prises.

L'ancêtre de la BDTC a été créée en 1978 sous le





Toponymic Data Base) was developed in 1978 as a replacement for a growing card-index registry, which had been maintained since the creation of the original Geographic Board of Canada in 1897. It was designed to increase the efficiency of gazetteer production and NTS names compilations. In 1987, the digital data base was remodelled into its current relational data base form. Today, the CGNDB is managed with ORACLE RDBMS software (Version 7.1.4), running on a SPARC 10, using the operating system SOLARIS 2.4. The use of character set ISO 8859 ensures the inclusion of accented characters used in Canada's French-language geographical names. Diacritics and syllabics found in some Canadian Aboriginal language names, and which are presently beyond the scope of most computer systems, are represented in the CGNDB by numerical substitutions. When international standards are accepted and implemented, the CGNDB records will be modified accordingly.

The CGNDB now contains over 500 000 geographical names records. Approximately 14% represent populated places/administrative areas, etc., 63% water features, and 23% terrain features (e.g., mountains and peninsulas). Each record includes a unique identifier, codes to indicate status, feature type, and the region or territory in which the place/feature lies, as well as several location fields. In some cases, historical information about the origin of the toponym is also included.

Approximately 67% of CGNDB records represent current official geographical names approved by the CPCGN. The remainder are unofficial; these may include other locally-used names for features, or formerly approved names that have been changed or rescinded.

The CGNDB records are currently distributed by jurisdiction in the following percentages:

Province / territory	%
Quebec	39.1
British Columbia	10.7
Newfoundland	7.2
Nova Scotia	6.3
Manitoba	4.8
New Brunswick	4.0
N.W.T.	3.9
Saskatchewan	3.0
Ontario	16.0

nom de Base nationale de données toponymiques, pour remplacer le fichier manuel que l'on tenait à jour depuis la création de la Commission de géographie du Canada, en 1897. Elle devait permettre d'accélérer et de rendre plus efficace la production des répertoires et des listes toponymiques du SNRC. En 1987, on l'a convertie en une base de données relationnelles qui est aujourd'hui gérée par le logiciel ORACLE (version 1.4) et tourne sur un SPARC 10 doté du système d'exploitation SOLARIS 2.3. On utilise le jeu de caractères ISO 8859 afin de reproduire les accents dans les noms géographiques de langue française. Dans la BDTC, les signes diacritiques et les caractères syllabiques employés dans l'écriture des toponymes autochtones, qui débordent les capacités de la plupart des systèmes informatiques actuels, sont représentés par des substitutions numériques. Après que des normes internationales auront été approuvées et mises en œuvre, les enregistrements de la BDTC seront modifiés en conséquence.

La BDTC renferme actuellement plus de 500 000 entrées toponymiques. Environ 14 p. 100 de ces entrées concernent des lieux habités / régions administratives, 63 p. 100 des étendues d'eau et 23 p. 100 diverses entités naturelles telles que des montagnes et des péninsules. Chaque entrée contient un identificateur, des codes indiquant le statut du nom, le type d'entité et la région ou le territoire dans lequel se trouve le lieu habité ou l'entité, ainsi que plusieurs champs de lieu. Dans certains cas, elle donne également de l'information sur l'origine du toponyme.

Près de 67 p. 100 des entrées de la BDTC se rapportent à des noms géographiques officiels, c'est-à-dire approuvés par le CPCNG. Les autres sont des toponymes non officiels; il peut s'agir de variantes ou d'autres noms utilisés localement, ou encore de noms qui ont déjà été officiels mais qui ont changé de statut.

Les entrées de la BDTC se répartissent ainsi par province ou territoire :

Province / territoire	%
Québec	39,1
Colombie-Britannique	10,7
Terre-Neuve	7,2
Nouvelle-Écosse	6,3
Manitoba	4,8
Nouveau-Brunswick	4,0
T.N.-O.	3,9
Saskatchewan	3,0
Ontario	16,0

Alberta	2.5
Yukon	1.1
Undersea features	0.8
P.E.I.	0.6

Alberta	2,5
Yukon	1,1
Entités sous-marines	0,8
Î.-P.-É.	0,6

### Fields of data

Names for a wide range of geographical features are stored on the CGNDB. Each record contains a numerical "generic code" which distinguishes the type of entity; over 1000 different generic codes are currently used. Using this code, records can be grouped into broader pre-determined categories, such as 'Unincorporated Rural Communities', 'Elevated Shoreline Features' or 'Ice and Snow Features'. Recently, these categories have been upgraded, and a standard set of 38 feature classes (22 of which refer to physical features) has been established for use in data distribution and in gazetteers.

The location of a feature is recorded on the CGNDB using several fields. A primary set of geographical coordinates indicates the centre of most types of features; although, for flowing-water features, coordinates of the mouth are recorded and headwater coordinates are also being included. The National Topographic System map on which each set of approved coordinates lies is maintained as a data field and records have now been upgraded to include the reference number of each additional NTS map (1:50 000 scale) on which the feature appears. Official records contain the names of at least one geographic or administrative unit in which the feature lies. Such units include Land Districts, Geographic Counties, Section-Township-Range, etc., depending on the province or territory. A location narrative field is used for many records to present a brief description of the whereabouts of the feature or place, usually in relation to a larger, more prominent feature or place.

The geographical coordinates stored on the CGNDB are determined by the names authority of each jurisdiction, normally from the NTS 1:50 000 scale maps. New fields have been included in the CGNDB to record the datum system of the map that was used for this purpose. Although some CGNDB coordinates do include seconds, these values for the majority of records have not yet been determined, and read as '00'. However, as more precision of coordinates is requested for GIS use, improvements are underway in several

### Champs de données

La BDTC couvre un large éventail d'entités géographiques. Chaque entrée contient un code de générique qui indique le type d'entité dont il s'agit. On emploie actuellement plus de 1000 différents codes de générique. Ce code nous permet de grouper les entrées en un certain nombre de catégories prédéterminées : agglomérations rurales non constituées, entités littorales élevées, entités de glace et de neige, etc. Ces catégories ont récemment fait l'objet d'un remaniement. On distingue désormais 38 classes d'entités (dont 22 concernent les entités physiques) pour la diffusion des données et la production des répertoires.

La position géographique d'une entité est indiquée dans la BDTC au moyen de plusieurs champs. Pour la plupart des types d'entités, on a les coordonnées géographiques approximatives du centre de l'entité. Dans le cas des cours d'eau, elle donne les coordonnées de l'embouchure et comprend de plus en plus souvent celles de la source. La carte du Système national de référence cartographique (SNRC) sur laquelle les coordonnées ont été prises est maintenue dans un champ de données et certaines entrées présentent le numéro de référence des autres cartes du SNRC sur lesquelles l'entité est représentée. Les fichiers toponymiques officiels contiennent le nom d'au moins une unité géographique ou administrative dans laquelle se trouve l'entité géographique; il peut s'agir d'un district, d'un comté géographique, d'une section-canton-rang, etc., selon la province ou le territoire. Dans un grand nombre de cas, un champ descriptif de lieu expose brièvement, sous forme narrative, la situation géographique de l'entité ou du lieu, en la situant par rapport à un élément plus important par sa taille.

Les coordonnées géographiques mémorisées dans la BDTC sont fournies par l'organisme toponymique de chacune des autorités compétentes et sont habituellement tirées d'une carte du SNRC à 1/50 000. De nouveaux champs indiquant le système de référence de la carte d'où proviennent les coordonnées ont été inclus à la BDTC. Bien que dans quelques entrées toponymiques, les coordonnées sont indiquées à la seconde près, les valeurs pour la majorité des entrées indiquent '00', n'étant pas encore





regions (for example, seconds are now available for all Manitoba records).

déterminées à ce niveau de précision. Cependant, comme les utilisateurs réclament des coordonnées de plus en plus précises, notamment pour les besoins des systèmes d'information géographique, des améliorations à cet égard sont actuellement apportées aux entrées de plusieurs régions (par exemple, le chiffre des secondes est maintenant disponible pour toutes les entrées du Manitoba).

Following is a brief description of the fields of data which can be made generally available from the CGNDB:

Voici une courte description de la plupart des champs de données employés dans la BDTC :

Field Name	Field Description	Nom du champ	Description du champ
Region Code	A two-digit numerical field identifying the province or territory of Canada where the feature/place is found.	Code de région	Zone numérique à deux chiffres servant à désigner la province ou le territoire où se trouve l'entité.
Feature Name	The name of the feature or place.	Nom de l'entité	Nom de l'entité ou du lieu habité.
Name Key	An upper-case version of the Feature Name, used for searching and sorting. All special and accented characters have been omitted.	Clé du toponyme	Nom de l'entité écrit en majuscules, sans caractères spéciaux ni accents, utilisé pour la recherche et le tri.
Unique Key	A five-character value assigned by the system to a newly-created record for unique identification of the record. The first character indicates the province or territory to which the feature/place belongs.	Identificateur	Groupe de cinq lettres que le système attribue à une nouvelle entrée pour l'identifier. Le premier caractère indique la province ou le territoire où se trouve l'entité.
Status Code	An alpha-numeric code that indicates the status of the name.	Code de statut	Code alphanumérique indiquant le statut du toponyme.
Border Flag	A flag that indicates whether a feature crosses a provincial/territorial or international boundary.	Indicateur de frontière	Code indiquant si une entité traverse une frontière provinciale/territoriale ou internationale.
Obscure Generic	A flag to identify records whose generics are not self-evident.	Nature du générique incertaine	Symbole identifiant les entrées toponymiques dont le générique ou l'absence de générique n'indique pas la vraie nature de l'entité.
Decision Date	The date, in the form 'DD-MM-YY', on which the province or territory officially recognized the name as shown in the record (for example, '06-06-89').	Date de décision	Date (JJ-MM-AA) à laquelle la province ou le territoire a officialisé le toponyme (ex. : 06-06-89).
Decision Date Century	A field identifying the century of the Decision Date. (Not included in the Decision Date field.)	Date décision - siècle	Champ indiquant le siècle (non compris dans la date de décision) au cours duquel la décision a été prise.



First Date	The date, in the form 'DD-MM-YY', on which a decision was first made for the name shown in the record.	Date d'entrée officielle	Date (JJ-MM-AA) à laquelle a été prise la décision relative au nom que porte l'entrée.
First Date Century	A field identifying the century of the First Date. (Not included in the First Date field.)	Date d'entrée officielle - siècle	Champ indiquant le siècle au cours duquel a eu lieu la première entrée officielle (non compris dans le champ de la date d'entrée officielle)
Change Date	The last date-of-change to fields of the CGNDB record in the form 'DD-MM-YY'. (System generated)	Date du changement	Date (JJ-MM-AA) de la dernière mise à jour de la fiche (champ rempli automatiquement par le système).
Generic Code	A numerical code which identifies the type of feature or place.	Code de générique	Code numérique indiquant le type d'entité ou de lieu.
Generic Term	The term indicating the type of feature or place. <sup>3</sup>	Générique	Terme indiquant le type d'entité ou de lieu. <sup>3</sup>
Cross-reference	The primary variant name for the feature/place.	Renvoi au répertoire toponymique	Variante principale de l'entité ou du lieu.
Cross-reference Unique Key	The five-character value of the Cross-reference (see Unique Key).	Renvoi Identificateur	Groupe de cinq caractères correspondant au renvoi (voir identificateur)
Gazetteer Map	The NTS 1:50 000 scale map (if not available, the 1:250 000 NTS or a Canadian Hydrographic Service chart) where the approved coordinates of the feature lie.	Carte du répertoire	Numéro de carte du SNRC à 1/50 000 (ou si non disponible, celle de la carte à 1/250 000 ou de la carte du Service hydrographique du Canada) où se situent les coordonnées approuvées de l'entité.
Latitude / Longitude	The approved coordinates of the feature/place.	Latitude / longitude	Coordonnées approuvées de l'entité ou du lieu.
Geo Location 1	The first level geographical unit in which the feature/place is located.	Lieu géogr. 1	Unité géographique de premier ordre dans laquelle se trouve l'entité ou le lieu.
Admin Location 1	The first level administrative unit in which the feature/place is located.	Lieu adm. 1	Région administrative de premier niveau dans laquelle se trouve l'entité ou le lieu.
Location Narrative	A brief description of the location of the feature/place.	Description du lieu	Courte description de la position de l'entité ou du lieu.
Park Code	A code identifying features/places that lie within, or cross the boundary of a national park or national park reserve, and which indicates the name of the park or reserve.	Code de parc	Code désignant les entités ou les lieux situés totalement ou partiellement dans un parc national ou une réserve de parc national, et donnant le nom du parc ou de la réserve.
Head Lat / Head Long	For flowing-water features, the headwater coordinates.	Lat. source / long. source	Dans le cas des cours d'eau, coordonnées de la source.
Head Map	The NTS 1:50 000 map where the headwater coordinates lie.	Carte source	Carte du SNRC à 1/50 000 d'où sont tirées les coordonnées de la source.



## Satellite files and shadow data bases

In addition to the types of records and fields described above, the CGNDB contains a number of satellite files of information related to geographical names and mapping.

- One such file is a registry of the names of Canada's World War II fatal casualties. This provides reference data consulted in the process of naming features in honour of Canadian war casualties. Ultimately, the records of those honoured should be linked to the geographical names records; so far, this has been completed for Saskatchewan and British Columbia, as well as for some records elsewhere in Canada.
- A set of records gathered solely for NTS names compilations is known as 'Special Records', and contains names not normally considered by the CPCGN, but required for topographical mapping: for example, the names of roads, dams, railways, bridges, and conservation areas, amongst others.
- Titles of NTS maps are verified or selected in a satellite file known as the 'Sheet Title' registry.
- Another essential part of the CGNDB records is the extents of the named features. At present, this large body of graphical data is still maintained on paper copies of NTS maps. As well as the CGNDB production data base, it is necessary to keep some associated updated data bases, for particular purposes.
- A small independent copy of the CGNDB (with 20% of the records) serves as an area to test programs, on-line forms, and procedures prior to their implementation in the main data base.
- Another version of the data base which will serve as a development area where new data models for components of the CGNDB can be tested, and a repository is included for ORACLE's Designer 2000 case software.

## Fichiers satellites et bases de données secondaires

En plus des types d'entrées et des champs décrits ci-dessus, la BDTC contient un certain nombre de fichiers satellites qui renferment de l'information complémentaire sur les toponymes et les cartes géographiques.

- Un de ces fichiers est un registre des noms des victimes de la Seconde Guerre mondiale contenant des données que l'on peut consulter afin de donner à des lieux des noms de canadiens morts à la guerre. Ces entrées seront tôt ou tard liées aux entrées toponymiques; jusqu'à maintenant, cela n'a été fait que pour la Saskatchewan et la Colombie-Britannique ainsi que pour certaines entrées ailleurs au Canada.
- De plus en plus, on emploie ce qu'il est convenu d'appeler des «fichiers spéciaux» pour la production des compilations toponymiques du SNRC. On y trouve des désignations sur lesquelles le CPCNG n'a pas à statuer en temps normal mais qui doivent figurer sur les cartes topographiques, comme les noms de routes, de barrages, de chemins de fer, de ponts et de zones de conservation.
- Le registre des titres de feuilles sert à vérifier ou à choisir les titres qui apparaissent au bas de chacune des cartes du SNRC.
- Les limites d'une entité est un autre élément d'information essentiel de la BDTC. Cette information, qui représente un grand volume de données graphiques, est encore conservée sur des copies imprimées des cartes du SNRC. Tout comme la base de données de production du CPCNG, il est nécessaire de tenir à jour certaines bases de données auxiliaires qui servent à des usages particuliers.
- Il existe une version abrégée de la BDTC (contenant 20% des enregistrements) qui sert à tester des programmes, des formulaires en ligne et des procédures avant leur implantation dans la base de données principale.
- Une autre version de la base de données servira de version de développement, où l'on pourra tester de nouveaux modèles de données pour les composantes de la BDTC; elle renferme un référentiel pour le logiciel ORACLE Designer 2000.

- For the purposes of making CGNDB data available to World Wide Web users, a copy data base has been created. This is updated daily from the production version of the CGNDB.

### Updating records in a digital environment

Many of the provincial and territorial organizations, from whom CGNDB data originates, are using digital systems to manage their toponymy. Relevant CGNDB records are made available as a starting point to any jurisdiction that wishes to initiate a digital data base of its own. From there, a CPCGN member will keep the CPCGN Secretariat informed of any name decisions in the jurisdiction, by forwarding updates for entry into the CGNDB. Although traditionally record updating has taken place from paper copy, the information transfer is now starting to be performed digitally, through the use of diskettes, magnetic tapes, and ftp data transfer, with upload scripts or programs. As the operating platforms of each jurisdiction differ, incoming data from each requires a particular upload procedure on the CGNDB; several are currently in development phases.

### Geographical names for mapping

The Geographical Names Section is required to provide up-to-date toponymy for each 1:50 000 or 1:250 000 NTS map produced or revised by the Centre for Topographic Information. Up to 500 names lists and map manuscripts are prepared each year from CGNDB records; each names list must still undergo a manual editing process before it accurately depicts the appropriate selection of names required for a particular map. Cartographers editing cartographic data from the National Topographic Data Base (NTDB) with digital systems capable of manipulating text, receive CGNDB names lists on diskettes. Currently, the integration of geographical names records from the CGNDB with digital cartographic data is in its early phases. For several thousand 1:50 000 scale map sheet areas, names as shown on the most recent printed map sheet have been loaded into the NTDB. At present, research is under way to establish a process for updating this

- Afin de rendre les données de la BDTC accessible aux utilisateurs du Web, on a créé une copie de la base de données. Cette copie est mise à jour quotidiennement à partir de la version de production de la BDTC.

### Mise à jour des fichiers dans un environnement numérique

Plusieurs des organismes provinciaux et territoriaux de qui la Section des noms géographiques obtient les données de la BDTC se servent de systèmes numériques pour gérer leurs données toponymiques. Les entrées de la BDTC pertinentes à leur région peuvent servir de point de départ à tout organisme qui désire entreprendre la numérisation de sa base de données. Par la suite, un membre du CPCNG tiendra le Secrétariat du CPCNG au courant des décisions de l'organisme toponymique et lui enverra des mises à jour à intégrer dans la BDTC. Bien que la mise à jour des entrées se soit effectuée jusqu'à maintenant par transmission de documents imprimés, cette opération se fait maintenant par voie électronique, en utilisant des disquettes ou des bandes magnétiques, et par transfert de données ftp à l'aide de programmes ou scripts de téléchargement. Par ailleurs, comme l'environnement informatique diffère d'une province à l'autre, le téléchargement des données dans la BDTC exige une procédure distincte pour chaque organisme; plusieurs procédures en sont à l'étape du développement.

### Toponymes et cartographie

La Section des noms géographiques doit fournir une liste à jour des toponymes pour chacune des cartes à 1/50 000 ou à 1/250 000 que produit ou révisé le Centre d'information topographique. Jusqu'à 500 listes et minutes toponymiques sont produites chaque année à partir des fiches de la BDTC; chaque liste toponymique doit être retouchée manuellement afin de représenter précisément les toponymes devant apparaître sur une carte spécifique. Les cartographes qui révisent des données cartographiques de la Base nationale de données topographiques (BNDB) au moyen de systèmes numériques capables de manipuler du texte, reçoivent les listes toponymiques sur disquette. L'intégration des enregistrements toponymiques de la BDTC à des données cartographiques numériques en est présentement aux toutes premières étapes. Pour plusieurs milliers de coupures de carte à 1/50 000, les toponymes





toponymy layer from the continually updated records of the CGNDB. In addition, exploration of the incorporation of a graphical element into the CGNDB to depict the extent of features, will undoubtedly be a part of the CGNDB's future development.

### **Links to other data bases**

The CGNDB's focal point is the geographical name itself and each name record has a unique identifier. Such geo-referenced records form a valuable search tool when linked to other federal and provincial data bases. A project is currently being completed to match CGNDB records to corresponding Statistics Canada place name records. This will provide a link between official CPCGN place names and population data, and also possibly postal codes. The Government of Canada is presently using the CGNDB records as the official authority file of geographical names, to be used as a reference for those filing environmental impact reports, now required by law. Plans have been developed for the regular import of records into the CGNDB from the Undersea Features Data Base, managed by the Canadian Hydrographic Service. As previously mentioned, work is in hand to associate the CGNDB toponymy with cartographic files of the National Topographic Data Base. Also within Natural Resources Canada, initiatives are in hand to improve links between various Departmental data bases, as well as to participate in the broader context of developing a Canadian Geospatial Data Infrastructure. Geographical names are basic components for such initiatives.

### **General availability of CGNDB data**

One long-term objective, that of providing public on-line access to CGNDB records, has recently been realized. As of August 1994, individuals having access to Internet may query official geographical names, consult information about the CPCGN and its publications, and find out how to order CGNDB data.

(URL English <http://geonames.NRCan.gc.ca>  
French <http://toponymes.RNCan.gc.ca>)

figurant sur les feuilles les plus récentes ont été chargés tels quels dans la BNDT. Les recherches se poursuivent en vue d'établir un processus pour synchroniser la mise à jour de cette couche de données toponymiques avec celle de la BDTC. De plus, au nombre des futurs développements de la BDTC figurera sans aucun doute la recherche de moyens pour représenter graphiquement les limites d'une entité dans la BDTC.

### **Liaisons avec d'autres bases de données**

La BDTC se rapporte essentiellement aux noms géographiques, et chaque entrée toponymique porte un code qui lui est exclusif. Ces entrées géoréférencées constituent un précieux outil de recherche lorsqu'elles sont reliées à d'autres bases de données fédérales et provinciales. Un autre projet est en cours pour faire correspondre les fiches de la BDTC aux fiches toponymiques de Statistique Canada. Un lien pourra ainsi être établi entre les noms de lieux officialisés par le CPCNG et les données démographiques, et peut-être aussi les codes postaux. Le gouvernement du Canada se sert actuellement de la BDTC comme source de référence autorisée des toponymes utilisés dans les rapports sur les incidences environnementales que la loi l'oblige à produire. On envisage actuellement d'importer régulièrement dans la BDTC des fichiers de la base de données sur les entités sous-marines que gère le Service hydrographique du Canada. Tel qu'il a été mentionné, nous sommes en voie de mettre en relation la nomenclature de la BNDT avec les fichiers cartographiques de la Base nationale de données topographiques. Par ailleurs, à Ressources naturelles Canada, on s'emploie à améliorer les liens entre les diverses bases de données du Ministère et, dans un contexte plus large, on contribue à l'édification de l'Infrastructure canadienne des données géospatiales. Les noms géographiques sont des composantes fondamentales de ces initiatives.

### **Diffusion à grande échelle des données de la BDTC**

Vient d'être réalisé un objectif à long terme du CPCNG : la diffusion au public, par voie électronique, des fiches de la BDTC. Depuis août 1994, les personnes ayant accès au réseau Internet peuvent interroger la base de données et obtenir des renseignements sur les noms géographiques officiels, sur le CPCNG et sur ses publications; et sur la façon de commander des données de la BDTC.

(URL Français <http://toponymes.RNCan.gc.ca>  
Anglais <http://geonames.NRCan.gc.ca>)



CGNDB data can be purchased: potential clients can choose from a list of available fields, regions and formats for a customized request, or select from more standardized products from the CGNDB. (Requests for data from a single province or territory are normally referred to that particular names authority for the opportunity to respond.)

For additional information about the CGNDB, how to acquire geographical names data, or about Canada's geographical names in general, please contact:

Geographical Names  
 Natural Resources Canada  
 Room 634, 615 Booth Street  
 Ottawa ON K1A 0E9  
 Telephone: (613) 992-3892  
 Fax: (613) 943-8282  
 e-mail: geonames@NRCan.gc.ca

**Endnotes**

1. This is an update of the article which appeared in English in *Canoma* 20(1) and in French in *Canoma* 21(1). It was presented at the Seventh United Nations Conference on the Standardization of Geographical Names as paper E/CONF.91/L.33.
2. Peter Revie, former Data Base Manager of the Canadian Geographical Names Data Base, Natural Resources Canada, and Helen Kerfoot, former Executive Secretary, Canadian Permanent Committee on Geographical Names.
3. Modification of the English text in *Canoma* 20(1).

On peut acheter des données de la BDTC; les clients peuvent commander un produit personnalisé, en choisissant les champs, les régions et les formats qui les intéressent, ou encore opter pour des produits plus standards dérivés de la BDTC. Les demandes de données limitées à une province ou à un territoire sont normalement transmises, dans un premier temps, à l'organisme provincial ou territorial compétent.

Pour en savoir plus sur la BDTC, sur la façon d'obtenir des données toponymiques ou sur les noms géographiques du Canada en général, vous êtes prié de communiquer avec :

Noms géographiques  
 Ressources naturelles Canada  
 615, rue Booth, pièce 634  
 Ottawa ON K1A 0E9  
 Téléphone : 613-992-3892  
 Télécopieur : 613-943-8282  
 Courrier élect. : toponymes@RNC.gc.ca

**Notes**

1. Le texte suivant constitue une mise à jour de l'article publié en anglais dans *Canoma*, vol. 20, no 1, juillet 1994 et en français dans *Canoma*, vol. 21, no1, juillet 1995. Il a été présenté à la septième Conférence des Nations Unies sur la normalisation des noms géographiques comme document E/CONF.91/L.33.
2. Peter Revie, ancien gestionnaire de la Base de données toponymiques du Canada, Ressources naturelles Canada et Helen Kerfoot, ancienne secrétaire exécutive du Comité permanent canadien des nom géographiques.
3. Modification à la définition du texte anglais - *Canoma*, vol. 20, no 1.

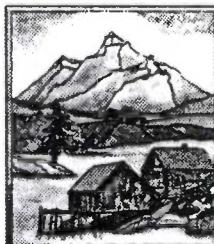



## TOPOS : La banque de données toponymiques - mise à jour de l'information

### TOPOS: Toponymic data bank - information update

*Alain Vallières and/et Benoît Boisvert<sup>1</sup>*

#### **A little background**

The configuration of the current system dates back to 1991, when it became urgent to update the platform, but not the system software, which was still powerful enough to adequately maintain and develop TOPOS. A list of current TOPOS fields is appended, along with the sequence chart for the system.

In 1997, a microcomputer distributor [P200-MMX] was added around the original hub of a Sun SparcServer 2 to provide network services that would meet the computer requirements of the staff of the Commission. The decision to network was justified, if only by the economy of scale resulting from the purchase of the office automation software site licenses.

With the arrival of a new Commission president, 18 microcomputers, which had become essential work tools for everyone involved in the ongoing management of Quebec toponymy, were replaced. Equipped with Pentium computers varying from 100 to 300 MHz, depending upon the duties of each person, the entire staff now has a means of accessing the electronic highway.

This technological advance had become essential because the Commission's main clients were contacting it more and more often by electronic mail. It is also anticipated that part of the cost of purchasing the new equipment will be recovered over the medium-term through savings in long-distance telephone charges.

When officials in charge of toponymy in Quebec decided to provide access to TOPOS from the Commission's web site, a microcomputer server (P300 MMX) was purchased for this purpose. For

#### **Un peu d'histoire**

La configuration du système actuel de la Commission de toponymie date déjà de 1991. Il était devenu urgent de procéder à une mise à niveau du matériel, à l'exclusion des logiciels de base qui demeurent assez performants pour assurer l'entretien et le développement adéquat de TOPOS. Les champs actuels de TOPOS sont présentés en annexe de même que le diagramme de fonctionnement du système.

En 1997, autour du noyau original constitué d'un mini-ordinateur Sun SparcServer 2 est venu se greffer un micro-serveur (P200-MMX) pour desservir, en réseau, les besoins en bureautique du personnel de la Commission. Le choix d'un réseau se justifie, notamment, par une économie d'échelle quant à l'acquisition des droits d'utilisation des logiciels bureautiques.

L'arrivée d'une nouvelle présidente à la direction de la Commission s'est traduite par le remplacement de 18 micro-ordinateurs, outils de travail devenus indispensables pour chacune des personnes jouant un rôle dans la gestion courante de la toponymie québécoise. Dorénavant dotée de Pentium dont la puissance varie entre 100 MHz à 300 MHz selon les fonctions de chacun et chacune, l'ensemble du personnel possède désormais une voie d'accès au réseau des autoroutes électroniques.

Les principales clientèles de la Commission, s'adressant de plus en plus à elle par l'entremise du courrier électronique cette ouverture à la technologie était devenue essentielle. De plus, il est prévu, qu'à moyen terme, une partie des coûts d'acquisition des nouveaux appareils sera récupérée à même les économies réalisées sur les frais interurbains de téléphonie.

Les autorités toponymiques québécoises ayant pris la décision d'offrir l'accès à TOPOS depuis le site Web de la Commission, un micro-ordinateur serveur (P300 MMX) a été acquis pour ce faire.

Office de la langue  
française

Fig. 1 Schéma du réseau local de la Commission de toponymie / Diagram of the Local Area Network at the Commission de toponymie (Source : CTQ)

security purposes, part of our data bank was doubled in size on a machine specifically dedicated to serving our web site; this machine had no link to the minicomputer on which day-to-day transactions—analyses, data processing, and official approvals—are performed.

### The web site of the Commission de toponymie

The interface between the TOPOS data bank and cartographic positioning was developed by Groupe Korem, a firm of consultants specializing in the use of MapInfo. The final product allows the user to conduct searches from the main TOPOS data fields (generic and specific searches of a particular name or type of feature, administrative region, regional county municipality or local municipality related to the toponym), cross-reference these fields, find the location of any official toponym on a local-, regional-, or national-scale map, download data, generate statistics, and more. Official terms are also accessible without cartographic support. It should be noted that, until a given data field has been screened, people consulting our web site will not initially be able to access information on the origin or meaning of

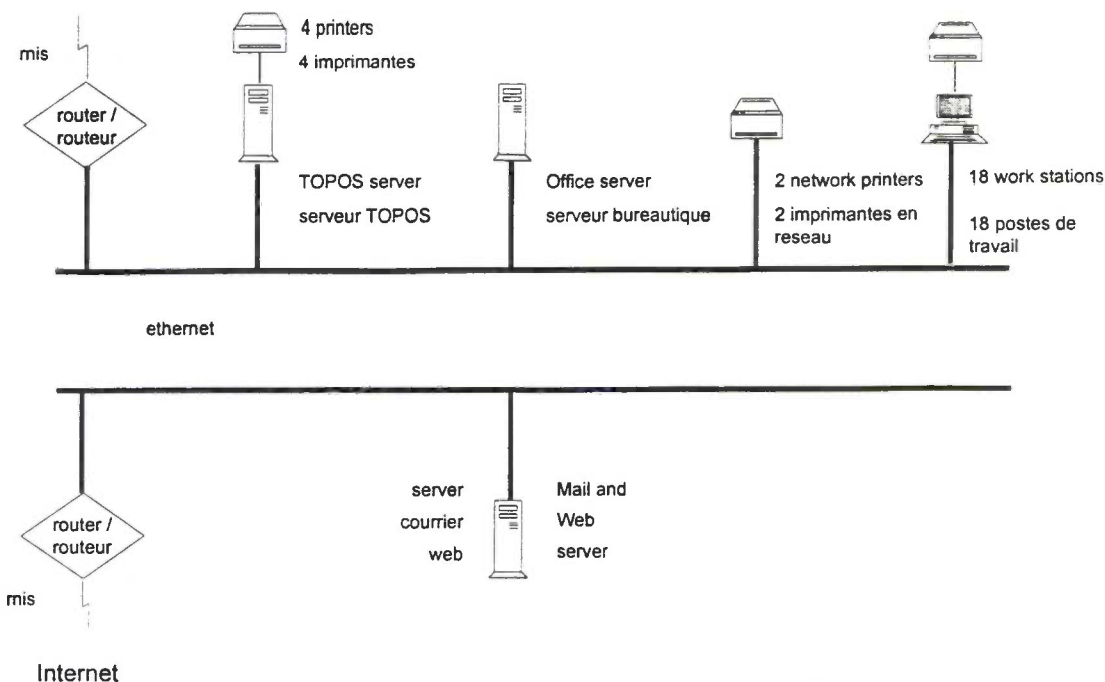
Question de sécurité, le dédoublement d'une partie de notre banque de données sur un appareil spécifiquement dévolu à la desserte de notre site Web et n'ayant aucun lien avec le mini-ordinateur sur lequel s'effectuent les transactions courantes, en regard de l'analyse, du traitement et de l'officialisation, a été privilégié.

### Le site web de la Commission de toponymie

Le développement de l'interface entre la banque de données TOPOS et le positionnement cartographique a été développé par le Groupe Korem, une firme de consultants spécialisés dans l'utilisation du logiciel MapInfo. Le produit final permet, notamment, d'effectuer des recherches à partir des principaux champs de TOPOS (spécifique et générique du nom recherché et type d'entité, région administrative, municipalité régionale de comté et municipalité locale associés au toponyme), d'en faire des recoupements, de localiser sur une carte d'échelle locale, régionale ou nationale, chacun des toponymes officiels, de télécharger des données, de générer des statistiques ... Les toponymes officiels sont aussi accessibles sans le support cartographique. À noter que dans une première phase, les personnes



toponyms. Access to certain technical information - major decisions by the Commission, a dictionary of geographical terms, the selection criteria and rules governing naming a feature and classifying place names, the periodical *Le Toponyme*, and so on, partially compensates for this shortfall.

intéressées à notre site web ne pourront consulter les informations concernant l'origine et la signification des toponymes et ce, jusqu'à l'épuration du champ en question. Cette lacune est en partie compensée par l'accès à certaines informations techniques dont, notamment, les décisions importantes prises par la Commission, un dictionnaire de terminologie géographique, les critères de choix et les règles d'écriture et de classement des noms de lieux, le bulletin *Le Toponyme* ...

	TOPOS server Serveur TOPOS	Office server Serveur bureautique	Web server Serveur web	Work stations Postes de travail
Computer / Ordinateur	Sun SparcServer2	P200-MMX	P300-MMX	P100 to P200- MMX
Operating system Système d'exploitation	Sun OS 4.1.1	Windows NT 4.0	Windows NT 4.0	Windows 95
RAM / Mémoire vive	48 Mb / Mo	128 Mb / Mo	128 Mb / Mo	32 Mb / Mo
Disk space / Espace	1.9 GB / Go	2.4 GB / Go	6.7 GB / Go	2.4 GB / Go
Backup unit / Unité de sauvegarde	Sun (150 Mb / Mo)		HP DAT 8 (8GB / Go)	
Software / Logiciels	Oracle V6.0.33	MS Office 97	IIS and IMS* FrontPage 97	SmartTerm (VT220 emulation)

\*IIS: Microsoft Information Server; IMS: Internet Mail Service

Le serveur bureautique sert aussi à diffuser les informations du *Grand dictionnaire terminologique* sur disque compact.  
/ The office automation server also contains the *Grand dictionnaire terminologique* on compact disk.

**Fig. 2 Configuration de système utilisé par la CTQ / CTQ system configuration**

In conclusion, the TOPOS computerized master toponymy system continues to provide a framework for the main stages of toponymic processing, from analysis, through storage and publication, to official approval. On 30 April 1998, the TOPOS data bank (over 150 MB in size) contained some 324 000 place names, each of which may theoretically be sorted on 30 different fields or variables.

En conclusion, le système principal de gestion informatisée de la toponymie, TOPOS, continue d'être le support sur lequel s'appuient les principales phases des étapes du traitement toponymique, soit de l'analyse à l'officialisation, en passant par la conservation et la diffusion. TOPOS, une banque de données de plus de 150 Mo contenait, au 30 avril 1998 quelques 324 000 noms de lieux, chacun pouvant théoriquement être assorties de 30 variables ou champs différents.

**Endnote/Note**

1. Alain Vallières, Directeur General, Direction toponymie, CTQ, (text/texte) and/et Benoît Boisvert, Analyste de l'informatique, CTQ, (graphics/graphiques), Québec.

# Nova Scotia Geographical Names Data Base

*Keith AuCoin and David Wills<sup>1</sup>*

The data base transfer agreement between Ottawa and Nova Scotia was signed late in 1995 with the data base being downloaded a short time later to a desktop PC. The data base currently resides on a Dell Optiplex GXa Pentium II with MMX, PC. A great deal of time was spent investigating the most appropriate software to serve Nova Scotia's short-term need to view and manipulate the data, with MapInfo being chosen as the best package for our requirements. Using MapInfo, all of Nova Scotia's place and feature names, along with 25 fields of data can easily be viewed and edited although no editing of data has as yet been carried out. For longer term applications, it is planned that Microsoft Access will be used.

At the present time, Nova Scotia is partially through the conversion of central coordinate points from NAD27 to NAD83, thus taking all points to the nearest second. Upon completion of the place name coordinate conversion project, which is expected sometime during 1998, attention will turn to upgrading coordinates to NAD 83 for the central reference points for all lakes within the Province. Following that, coordinate conversion for the remaining geographical features will take place.

There is continued interest from various parties to purchase the place names portion of the Nova Scotia Geographical Names Data Base. Distribution agreements with other government departments and private companies have yet to be prepared; however, draft agreements are being looked at. Upon compilation of the place name coordinate conversion project, it is planned to move forward with the new distribution strategies.

Nova Scotia is exploring the possibility of making the data set available within the Government Network, in a read-only format. There has been some interest expressed by other departments dealing with land-related issues, i.e., mapping, signage, Land Grants, Deeds, etc., that the availability of updated geographic names data would be most helpful. The decision to proceed on this matter is under review and has been given positive consideration to date.

## Endnote

1. Keith AuCoin, Nova Scotia Member, and David Wills, Coordinator, Geographical Names, Halifax.



## More quotes from the Geographic Board of Canada's minutes

### 7 March 1916 - Name of the Northwest Territories

Col. Anderson gave notice of the following motion for next meeting.

"That the attention of the Government be called to the fact that the name "North West Territories" no longer designates the unorganized district of Canada, especially since the territory of Yukon was organized and defined, and this Board respectfully recommends a change in the name, either to "Northern Territories" or to some specific designation".

### 25 April 1916

Col. Anderson's motion re Northwest Territories. To be brought personally before Dr. Roche by Chairman.

No further mention of this subject appears.

## Alberta's Geographical Names Inventory Database

Merrily Aubrey<sup>1</sup>

In 1996, through the good offices of the Friends of Geographical Names of Alberta Society, the Geographical Names Program was able to acquire a PC which would become the platform for a new and improved data base. A contractor was hired to build the database and create a conversion program to translate the old MacIntosh/4th Dimension setup to the new hardware and software.

The hardware now consists of a Pentium 100 (15 January 1996 state-of-the-art, and passé a day later) with over four gigabytes of memory. It also has a scanner, CD-ROM and a read-write drive which uses CDS with a 1.6 gigabyte capacity.

Using Watcom as the data base and PowerBuilder as the Windows development tool to communicate with Watcom, a much more user-friendly, faster, Windows 3.1-based system was developed. Basing it on the data base set-up as described in an earlier edition of *Canoma* it has improved the capacity, searching capabilities, and speed. It has the added feature of being able to store graphics for each feature. Using the scanner, any type of visual can be tied to any feature. It also has built into it five levels of security, from the basic "Guest" to the "System Administrator" The "Guest" allows read-only access to the geographical and origin information screens. The "System Administrator" is allowed access to everything. It is the System Administrator only who has access to adding or deleting items from the feature type and classification fields, along with adding or deleting users and their passwords.

If the public wants to use the data base, it will be at the guest level. This takes into consideration privacy issues arising from the Freedom of Information and Privacy Protection Act. As part of the Research and Publications Program's current business plan there is a commitment to "making the most commonly consulted portions of the Geographic Names data base available through the internet (99/00)."

The search screen allows access by name, feature type, subject classification, NTS map sheet number, latitude and longitude, and "legal" description. There are a number of different reports that can be generated. The summary report is a simple listing of name, feature type, and map sheet. The origin report gives the geographic information plus origin summary. The complete report, of course, gives all the details including the geographic information, origin information, secondary sources, primary/documentary sources, and in-person interviews.

The program is a pleasure to work with, and will take us well into the 21st century.

### Endnote

1. Merrily Aubrey, Geographical Names Program Co-ordinator, Historic Sites and Archives Service, Edmonton.



### Publications of interest / Publications d'intérêt

Crocker, Dorothy, ed. (1991): *Albamarle: a history of the township* [ISBN 0-9695680-0-2]; Albamarle Township Historical Society; \$30 [+ \$5 p + h].

Hattersley-Smith, Geoffrey (1998): *Geographical Names of the Ellesmere Island National Park Reserve and Vicinity* [ISBN 0-919034-96-9]; Parks Canada / Parcs Canada and /et Arctic Institute of North America (of the University of Calgary).

# Geographical Names Data Base (MGNDB)

Gerald F. Holm<sup>1</sup>

## Introduction

In the early 1970s, Manitoba initiated the computerization of its geographical name file cards, never knowing that it would be the beginning of a turn-of-the-century toponymic information system. We have come a long way - from those specialized 'punch' cards used with mainframe computers to digital names layers for geographic information systems (GIS) in a PC environment.

The most significant changes occurred during the 1990s with management support in creating application software, in approving computer upgrades, in the Commemorative Names Project, and in the hiring of an assistant toponymist, Des Kappel. With the new technology and Des' experience in GIS systems, both staff and volunteers are now able to easily, quickly, and graphically respond to inquiries from the public,

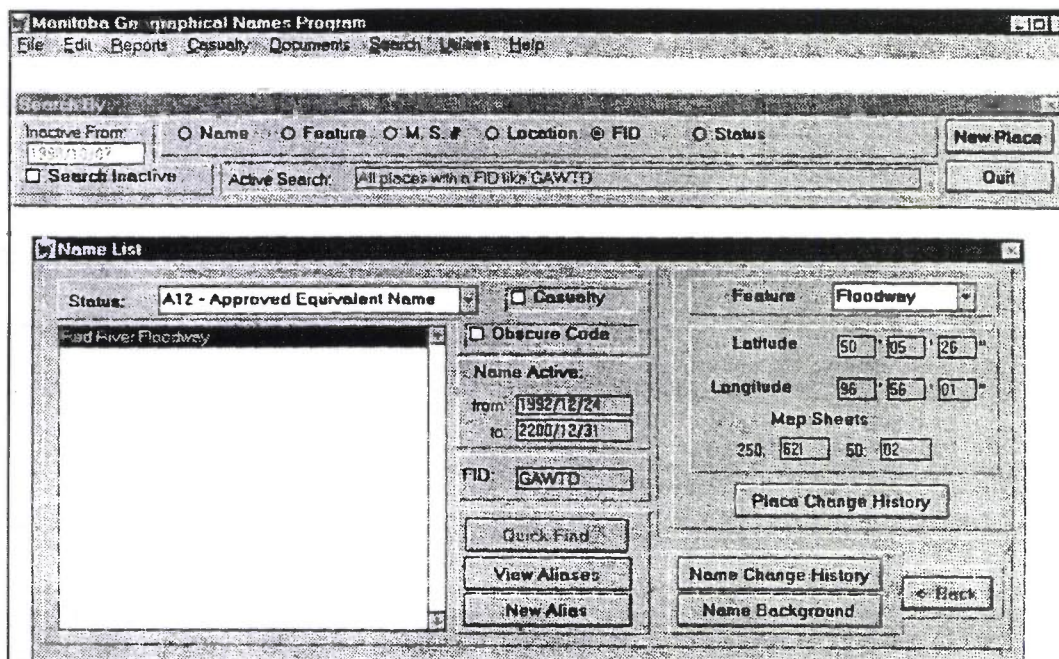

Fig. 1 MGNDB Name query response for Red River Floodway

industry and government. We also have the capability to provide toponymic quality control updates and corrections directly on in-house digital mapping products.

## Configuration of the Manitoba Geographical Names Data Base

Since 1994, the Manitoba Geographical Names Program (MGNP), has been using a geographical names data base developed on FoxPro 2.5 for Windows. This system, originally referred to as the Toponymic Access Database Application (TADA), and now the MGNDB, was an application developed by Linnet Geomatics International.

It is installed on two Windows NT workstations: an Intel 486DX2 with 32 Mb of RAM and 3.0 Gb of storage, and an Intel 133 Pentium with 32 Mb of RAM and 2.2 Gb of storage. It is also installed on the Windows 3.11 workstation with an IBM 486DM with 7Mb of RAM and 81.1 Mb of storage.

The system operates on FoxPro 2.5 for Windows into which the separate tables of geographical names data were imported. The tables are linked together and include feature, unique code, geographical coordinates, date approved, etc. A Graphical User Interface (GUI) was created for users, enabling them to query the data base from a Windows environment by typing in the search





request and having the response displayed on their operating system.

Information may be searched for by name, feature, topographic map sheet, location, unique code, or status. Searches may be conducted for active names only or may include inactive (unofficial, rescinded, historic, etc.) names. Data returned as a result of a search includes date approved, status, geographical coordinates, name background, feature, unique code, and topographical map sheet number.

The MGNDB allows users to query the data base directly from a GUI environment and prepare reports such as "Search by Lat/Long" with a 'user

established' buffer and "Print Active Search". This was included in the data base application to simplify a user's ability to find data within specific boundaries and to disseminate hard copy information quickly and efficiently on request.

Between 1995 and 1997, the system was upgraded several times to improve reports required to disseminate work researched and compiled by the staff. Many of these upgrades supported the creation of a sub-system to accommodate Manitoba's Commemorative Names Project. Under this project, the province named more than 4000 features after its World War II Fatal Casualties. The sub-system is able to prepare specialized reports for this project such as the following:

Manitoba List of World War II Fatal Casualties Samples

Rank	Name Community Electoral Div	Reg No Served With Buried At	Date of Death	Feature Name	Latitude Longitude Map Sheet Date Approved	Family Contacted
Pts.	Aandal, Rolf Bernard Winnipeg (St. Vital) 6	H 18844 Calgary Highlanders Groesbeek Canadian War Cemetery, Holland	1944/12/16	Aandal Lake	58°28'23" 101°38'55" 84K /05 1972/04/14	Yes
Sgt.	Abbott, William Geoffrey Winnipeg 6	R 100271 #408 Hampden Squadron, Air Gunner Bournemouth North Cemetery, England	1943/05/23	Abbott Lake	59°39'52" 97°19'54" 64P /11 1974/12/27	
Sgt.	Abel, Frederick James Langruth 6	H 6154 Winnipeg Grenadiers Sawwan Bay Cemetery, Hong Kong	1942/11/28	Abel Lake	58°59'30" 100°38'45" 84K /15 1972/04/26	Yes

Fig. 2: A sample of data for each of the 4175 Manitoba World War II Fatal Casualties

Another of the specialized reports the MGNP has been able to prepare is the *Cumulative Supplement to the Gazetteer of Canada: Manitoba* (1994). This was accomplished with the use of FoxPro 2.5 and its Relational Query By Example (RQBE) application. The RQBE imported the tables required and allowed users to select criteria that would be displayed.

**More recent upgrades**

In 1997, two Geographical Information Systems (ArcView - version 3.0 and CARIS - version 4.2.7 - later version 4.3) were added to the computer technology employed by the program.

The Integrated Resource Management System (IRMS) is a custom application also developed by Linnet Geomatics International using Environmental System Research Institute (ESRI) ArcView (version 3.0). This Geographical Information System (GIS) incorporates data from many government departments to create the Manitoba Land Related Information System. The names or 'toponymy' layer is regularly provided by our office and enables users of the IRMS to access current toponymic information.

Cumulative Supplement		Supplément cumulé			
Gazetteer of Canada		Répertoire géographique du Canada			
- Manitoba (1994)		- Manitoba (1994)			
from / de 94 04 01		to / à 98 06 30			
Name	Feature Name Nom de l'entité	Ship Cote	Latitude Longitude	Status Code de statut	Deadline Date Date de clôture
A					
Adrian Creek	Creek (1)	634 / 07	59°28'37" 100°48'00"	A1	06 03 13
Adrian Hill	Hill	660 / 07	59°17'18" 99°42'22"	A1	06 02 28
Adrian Lake	Lake	640 / 11	57°40'23" 99°40'00"	A1	04 12 16
Adrian Rapids	Rapids	640 / 04	59°08'48" 99°42'22"	A1	06 02 28
Adolf Anderson Lake	Lake	648 / 05	59°08'41" 99°37'36"	A1	06 03 24
Adrian Lake	Lake	636 / 11	54°28'58" 99°17'00"	A1	06 03 31
Adrian Island	Island	631 / 07	54°29'34" 99°43'34"	A1	06 03 13
Adrian Lake	Lake	646 / 03	57°14'54" 101°29'32"	A1	04 12 16
Alan Johnston Bay	Bay	644 / 05	59°23'17" 101°51'40"	A6	06 03 24
Albert Green Lake	Lake	638 / 04	59°10'11" 99°58'38"	A1	06 02 28
Albert Collins Lake	Lake	636 / 13	54°58'48" 99°41'32"	A1	06 03 24
Albert Harrison Lake	Lake	638 / 12	54°29'17" 99°41'18"	A1	06 03 24
Albert Henry Lake	Lake	641 / 14	59°48'18" 97°21'10"	A1	06 03 24
Albert Phillips Lake	Lake	631 / 08	54°18'37" 99°23'00"	A1	06 03 13
Albert Woods Lake	Lake	644 / 02	59°14'21" 100°50'00"	A1	06 03 24
Alexander	Rural Municipality	621 / 08	59°29'00"	A1	04 12 28
Alexander Bay	Bay	637 / 13	57°37'25" 99°48'22"	A1	06 03 28
Alexander Graham Lake	Lake	644 / 16	59°37'31" 99°19'17"	A1	06 03 21
Alexander Island	Island	632 / 15	53°59'57" 99°48'08"	A1	06 03 31
Alexander Lake	Lake	639 / 03	59°09'31" 97°01'32"	A1	06 02 20
Alexander McFay Lake	Lake	638 / 01	54°07'32" 99°40'28"	A1	06 03 31
Alexander Stewart Lake	Lake	632 / 14	53°47'37" 99°02'01"	A1	07 11 21
Alexander Ross Lake	Lake	646 / 13	57°45'18" 99°28'23"	A1	06 03 31
Alexander Thomson Island	Island	641 / 18	59°53'32" 99°18'31"	A1	06 03 24
Alexander Thomson Lake	Lake	642 / 04	57°09'58" 99°13'46"	A1	06 03 21
Alexander Young Lake	Lake	636 / 08	54°29'11" 97°12'33"	A1	06 03 21
Alfred Hanson Lake	Lake	631 / 04	54°01'33" 99°58'20"	A1	06 02 18
Alfred Johnson Island	Island	644 / 05	57°23'22" 97°31'33"	A1	06 01 31
Alfred Moore Bay	Bay	632 / 15	53°59'04"	A1	06 03 31
Alfred Smith Island	Island	641 / 15	59°34'33" 99°58'04"	A1	06 03 24
Alfred Smith Lake	Lake	646 / 08	59°14'42" 100°29'10"	A1	06 03 24
Allen Bay	Bay	631 / 16	54°24'12" 99°58'34"	A1	06 03 24
Allen Hill	Hill	642 / 14	59°51'30" 99°08'08"	A1	06 03 31
Allen Island	Island	647 / 02	57°01'07" 101°28'12"	A1	04 12 16
Alan Johnston Bay	Bay	644 / 05	59°23'17" 101°51'40"	A6	06 03 24
Alan Green Lake	Lake	636 / 08	54°29'11" 99°48'08"	A1	06 03 31
Alan McDonald Lake	Lake	647 / 03	57°11'40" 99°48'01"	A1	06 03 31
Alan Parker Lake	Lake	636 / 11	54°29'16" 97°02'42"	A1	06 03 31
Alan Pennington	Parish	644 / 08	59°22'17" 101°52'51"	A1	06 03 24
Alan Pickett	Pickett	648 / 13	54°49'36" 97°49'47"	A1	06 03 24
Alan Robertson Lake	Lake	631 / 15	54°48'58" 99°27'31"	A1	06 03 31
Alan Grant	Creek (1)	641 / 16	59°54'45" 99°58'00"	A1	06 03 24
Allen Hill	Hill	647 / 12	59°29'50" 97°34'48"	A1	06 03 24
Allen Island	Island	647 / 01	57°01'23" 100°17'36"	A1	06 03 24
Allen Lake	Lake	621 / 14	59°29'00"	A1	04 12 28
Allen Hill	Hill	636 / 11	55°26'33" 99°21'14"	A1	06 03 27
Ameroneth Beach Provincial Recreation	Provincial Recreation	622 / 10	50°38'54" 99°28'41"	B2	76 02 18
Amos	Park				
Amos Park Reserve	Park Reserve	644 / 13	59°47'28" 97°58'17"	A6	07 08 11
Anderson Lake	Lake	647 / 03	57°10'08" 101°29'04"	A1	04 12 16
Anderson Rapids	Rapids	640 / 15	59°51'14" 99°28'38"	A1	06 02 28
Anderson Lake	Lake	621 / 07	59°21'14" 99°48'00"	A6	06 03 18
Anderson Rapids	Rapids	642 / 11	59°51'37" 101°11'52"	A1	06 02 28
Andrew Lake	Lake	644 / 08	59°29'51" 100°28'48"	A1	06 03 24
Andrew Bay	Bay	646 / 15	59°29'00"	A1	06 03 31
Andrew Lake	Lake	636 / 07	59°28'02" 99°58'00"	A1	06 02 20
Angus Pickett	Pickett	631 / 12	54°28'30" 99°48'21"	B2	06 03 31

Fig 3: A sample of the *Cumulative Supplement to the Gazetteer of Canada: Manitoba* (1994).



The IRMS also provides the MGNP staff with the ability to produce maps displaying as much or as little data as required for purposes of dissemination or research.

CARIS (Computer Aided Resource Information System) version 4.3 is currently being used in the MGNP to provide toponymic checks for Manitoba base maps. They are compiled by Land Information Centre staff also using CARIS. These toponymy checks are being completed to ensure that only approved, current toponyms appear on provincial map products.

**Summary**

As you can see, Manitoba's Geographical Names Program has made considerable progress since the first computer cards were key-punched. We will continue to strive for improvement to ensure we meet the needs of government and the public in the provision of toponymic services.

**Endnote**

1. Gerald F. Holm, Provincial Toponymist and Manitoba CPCGN member, Winnipeg.



**Some meetings concerning names /  
Quelques réunions sur les noms**

	1998	
Western States Geographic Names Conference	8-12 Sept./sept.	Cody, Wyoming
Canadian Permanent Committee on Geographical Names / Comité permanent canadien des noms géographiques	15-18 Sept./sept.	Regina, Saskatchewan
American Name Society	27-30 Dec./déc.	San Francisco, California
	1999	
Canadian Society for the Study of Names / Société canadienne d'onomastique	4-5 June/juin	Lennoxville, Que./Qué.
American Name Society	27-30 Dec./déc.	Chicago, Illinois

**International Congress of Onomastic Sciences /  
Congrès International des Sciences Onomastics**

URL - <http://www.usc.es:8080/~ilgas/icos/inicio.html>





# Ontario post office locations

Robert C. Smith<sup>1</sup>

Ten years after the publication of *Ontario Post Offices*, there are still a number of post offices which operated in Northern Ontario for which I have been unable to determine a definitive location. In the hope of obtaining some help from readers of *Canoma*, I have decided to publish a list of these offices, presented below. Question marks have been placed beside the information which is uncertain. It will be noted that in the cases of six

of these offices, even the district in which they were located is not known with certainty; in other cases, the township is either uncertain or completely unknown (or the geographical coordinates if they were in unsurveyed areas). If readers know where any of these mostly short-lived post offices were located, please contact me at Box 9383, Station T, Ottawa, Ontario K1G 3V1.

	Opened	Closed	Township	District
Allard Mill	1926 07 27	1926 09 29	Laberge?	THB
Burk's Head Quarters	1885 02 01	1885 05 31	?	THB? ALG?
Crown City	1925 03 30	1931 11 21	McVittie?	TSK
Fleury	1905 11 01	1907 12 31	Strathy?	NIP L Grey Siding
Grey Siding	1908 01 01	1908 06 27	Strathy?	NIP F Fleury
	1908 09 01	1910 04 11		
Goldie	1913 12 22	1914 10 09	Delmage?	SUD
Gravel Station	1913 08 25	1914 11 25	Wiggins?	THB?
Huronina Mine	1915 02 01	1917 08 15	?	TSK?
Little Forks	1892 01 01	1893 04 30	Woodyatt?	RRV?
Munroe Siding	1904 10 17	1911 01 20	Morse?	SUD
Northpines	1913 05 12	1928 11 30	Drayton?	KNR?
Reddick Bay	1907 07 01	1908 12 01	?	TSK
	1908 12 01	1910 01 11		
South Gowganda	1909 02 17	1909 03 27	?	SUD

## Abbreviations

ALG - Algoma  
 F - Formerly  
 KNR - Kenora

L - Later  
 NIP - Nipissing  
 RRV - Rainy River

SUD - Sudbury  
 THB - Thunder Bay  
 TSK - Timiskaming

## Endnotes

1. Robert C. Smith, editor of the *PHSC Journal* for the Postal History Society of Canada, Ottawa.
2. Smith, Robert C. (1988): *Ontario Post Offices*, The Unitrade Press, Toronto.

# Recent municipal changes in Canada

## Changements municipaux récents au Canada

Kathleen O'Brien<sup>1</sup>

Municipal changes occurred in several provinces. Many of the changes were done in a "global" sense, in that several or, in some cases, all of the entities of one category or status of municipality changed to another. This was true for the Counties in Alberta and the Communities in Newfoundland.

Il y eut des changements municipaux dans plusieurs provinces. Plusieurs des changements se firent en bloc, c'est-à-dire que plusieurs, ou dans certains cas, toutes les entités d'une catégorie ou ayant un statut de municipalité changea pour celui d'un autre. Tel fut le cas pour les comtés en Alberta et les communautés à Terre-Neuve.

### Alberta

**Note:** All Counties in Alberta became Municipal Districts but retained the word 'county' in their names, according to the *Municipal Government Act*; effective date 1 January 1995. So, all counties listed below have the status of Municipal District.

The City of Drumheller amalgamated with the Municipal District of Badlands No. 7 as the Town of Drumheller on 1 January 1998 by OC 414/97.

OC 480/97 changed the status of Legal from Village to Town on 1 January 1998.

The County of Mountain View No. 17 changed its name to Mountain View County by OC 15/98 on 21 January 1998.

The County of Flagstaff No. 29 changed its name to Flagstaff County on 28 January 1998 by OC 21/98.

The Municipal District of Kneehill No. 48 changed its name to Kneehill County on 31 March 1998 by OC 38/98.

The Town of Gleichen was dissolved on 31 March 1998 by OC 61/98. The name will be retained in the Canadian Geographical Names Data Base as a Locality.

The County of Vulcan No. 2 changed its name to Vulcan County by OC 163/98 on 29 April 1998.

### Alberta

**À noter :** Depuis le 1<sup>er</sup> janvier 1995, tous les comtés (Counties) en Alberta devinrent des districts municipaux (Municipal District) mais conservèrent le terme "county" dans leur nom, selon la Loi sur les municipalités. Donc, tous les comtés mentionnés ci-dessous ont le statut de district municipal. [Nous avons décidé de retenir le terme anglais des structures municipales lorsqu'ils font partie intégrante du toponyme.]

La grande ville (City) de Drumheller se fusionna avec le Municipal District of Badlands No. 7 pour former la ville (Town) de Drumheller, le 1<sup>er</sup> janvier 1998, selon le décret OC 414/97.

Le décret OC 480/97 changea le statut de Legal de village à ville, le 1<sup>er</sup> janvier 1998.

Le County of Mountain View No. 17 changea son nom pour celui de Mountain View County selon le décret OC 15/98, le 21 janvier 1998.

Le County of Flagstaff No. 29 changea son nom pour celui de Flagstaff County, le 28 janvier 1998, selon le décret OC 21/98.

Le Municipal District of Kneehill No. 48 changea son nom pour celui de Kneehill County, le 31 mars 1998, selon le décret OC 38/98.

La ville de Gleichen fut dissoute le 31 mars 1998, selon le décret OC 61/98. Le toponyme sera retenu dans la Base de données toponymiques du Canada comme localité.

Le County of Vulcan No. 2 changea son nom pour celui de Vulcan County selon le décret OC 163/98, le 29 avril 1998.





The **Municipal District of Starland No. 47** changed its name to **Starland County** by OC 205/98 on 20 May 1998.

**Evansburg** (Village) was dissolved by OC 222/98 on 30 June 1998. Evansburg will be retained on the CGNDB as a Locality.

The area of the **Municipal District of Bonnyville No. 87** was altered when **Lakeland County** was created from it by OC 252/98 on 1 July 1998.

The **Municipal District of Yellowhead No. 94** changed its name to **Yellowhead County** by OC 282/98 on 8 July 1998.

---

### Manitoba

**Steinbach** changed its status from Town to City on 10 October 1997 by Man. Reg. 202/97 under *The Municipal Act* and by OIC 525/1997.

The following Villages became Towns on 10 October 1997 by Man. Reg. 202/97 under *The Municipal Act* and by OIC 525/1997: **Arborg, Erickson, Lac du Bonnet, Rossburn, Ste. Anne, Shoal Lake, and Teulon.**

The following Local Government Districts became Towns on 28 February 1997 by Man. Reg. 41/97 and *The Local Government Districts Act*: **Churchill, Gillam, Grand Rapids, and Lynn Lake.**

The following Local Government Districts became Rural Municipalities on 28 February 1997 by Man. Reg. 41/97 and *The Local Government Districts Act*: **Alexander, Alonsa, Armstrong, Fisher, Grahamdale, Mountain, Park, Piney, Reynolds, and Stuartburn.**

The Rural Municipality of **Consol** became the Rural Municipality of **Kelsey** on 10 October 1997 by Reg. 202/97 and *The Municipal Act* and by OIC 525/1997.

---

### New Brunswick

The Villages of **Renforth, East Riverside-Kinghurst, and Fairvale** and the Town of **Rothesay** amalgamated as the Town of **Rothesay** on 1 January 1998. Renforth, East Riverside-

**The Municipal District of Starland No. 47** changea son nom pour celui de **Starland County** selon le décret OC 205/98, le 20 mai 1998.

**Evansburg** (village) fut dissous selon le décret OC 222/98, le 30 juin 1998. Evansburg sera retenu dans la BDTC comme localité.

Une portion du **Municipal District of Bonnyville No. 87** fut modifiée lorsque le **Lakeland County** fut créé selon le décret OC 252/98, le 1<sup>er</sup> juillet 1998.

**The Municipal District of Yellowhead No. 94** changea son nom pour celui de **Yellowhead County** selon le décret OC 282/98, le 8 juillet 1998.

---

### Manitoba

**Steinbach** changea son statut de ville (Town) à grande ville (City), le 10 octobre 1997 selon la législation suivante : Man. Reg. 202/97, Loi des municipalités et le décret OIC 525/1997.

Les villages ci-dessous devinrent des villes, le 10 octobre 1997, selon la législation suivante : Man. Reg. 202/97, Loi sur les municipalités et le décret OIC 525/1997 : **Arborg, Erickson, Lac du Bonnet, Rossburn, Ste. Anne, Shoal Lake et Teulon.**

Les districts de gouvernement local ci-dessous devinrent des villes, le 28 février 1997, selon la législation suivante : Man. Reg. 41/97 et la Loi sur les districts de gouvernement local. **Churchill, Gillam, Grand Rapids et Lynn Lake.**

Les districts de gouvernement local ci-dessous devinrent des municipalités rurales, le 28 février 1997, selon la législation suivante : Man. Reg. 41/97 et la Loi sur les districts de gouvernement local. **Alexander, Alonsa, Armstrong, Fisher, Grahamdale, Mountain, Park, Piney, Reynolds et Stuartburn.**

La municipalité rurale de **Consol** devint la municipalité rurale de **Kelsey**, le 10 octobre 1997, selon le règlement Reg. 202/97, la Loi sur les municipalités et le décret OIC 525/1997.

---

### Nouveau-Brunswick

Les villages de **Renforth, East Riverside-Kinghurst et Fairvale** et la ville de **Rothesay** se fusionnèrent pour former la ville de **Rothesay**, le 1<sup>er</sup> janvier 1998. Renforth, East Riverside-

Kinghurst, and Fairvale will appear as Urban Communities in the CGNDB.

**Quispamsis (Town)** and **Gondola Point (Village)** amalgamated as **Quispamsis (Town)** on 1 January 1998. Gondola Point will appear as an Urban Community in the CGNDB.

The Town of **Grand Bay** and the Village of **Westfield** amalgamated as the Town of **Grand Bay-Westfield** on 1 January 1998. Grand Bay and Westfield will appear as Urban Communities in the CGNDB.

The Villages of **Saint-Basile**, **Saint-Jacques**, and **Verret** amalgamated with the **City of Edmundston** as **Edmundston (City)** on 1 January 1998. Saint-Basile, Saint-Jacques, and Verret will appear as Urban Communities in the CGNDB.

### Newfoundland

The following Communities were upgraded in status to Towns on 1 January 1997 under the *Municipalities Amendment Act, C.25, 1996*: **Admiral's Beach; Anchor Point; Aquaforte; Baine Harbour; Baytona; Beachside; Bellburns; Bide Arm; Bird Cove; Biscay Bay; Bishop's Cove; Branch; Brent's Cove; Brighton; Bryant's Cove; Burlington; Cape Broyle; Cape St. George-Petit Jardin-Grand Jardin-De Grau-Marches Point-Loretto; Cartwright; Charlottetown; Coachman's Cove; Colinet; Comfort Cove-Newstead; Conche; Cormack; Cox's Cove; Crow Head; Daniel's Harbour; Davis Inlet; Duntara; English Harbour East; Fermeuse; Ferryland; Forteau; Fox Harbour; Frenchman's Cove; Gallants; Gaskiers-Point La Haye; Gillams; Glenburnie-Birchy Head-Shoal Brook; Goose Cove East; Grand Le Pierre; Great Harbour Deep; Hampden; Happy Adventure; Hermitage-Sandyville; Hopedale; Hughes Brook; Indian Bay (Parsons Point); Jackson's Arm; Keels; King's Cove; L'Anse-au-Clair; L'Anse-au-Loup; Lark Harbour; Leading Tickles West; Lewin's Cove; Little Bay; Little Bay East; Little Bay Islands; Lord's Cove; Lourdes; Lushes Bight-Beaumont-Beaumont North; Makkovik; Mary's Harbour; McIver's; Meadows; Melrose; Middle Arm, Green Bay; Miles Cove; Millertown; Ming's Bight; Morrisville; Nippers Harbour; Norris Point; North River; Pacquet; Parkers Cove; Parson's Pond; Pilley's Island; Pinware; Plate Cove East; Plate Cove West; Point au Gaul; Point Lance; Point May; Point of Bay; Pool's Cove;**

Kinghurst, et Fairvale seront retenus comme communautés urbaines dans la BDTC.

**Quispamsis (ville)** et **Gondola Point (village)** se fusionnèrent pour former **Quispamsis (ville)**, le 1<sup>er</sup> janvier 1998. Gondola Point sera retenu comme communauté urbaine dans la BDTC.

La ville de **Grand Bay** et le village de **Westfield** se fusionnèrent pour former la ville de **Grand Bay-Westfield**, le 1<sup>er</sup> janvier 1998. Grand Bay et Westfield seront retenus comme communautés urbaines dans la BDTC.

Les villages de **Saint-Basile**, **Saint-Jacques** et **Verret** se fusionnèrent avec la grande ville d'**Edmundston**, le 1<sup>er</sup> janvier 1998. Saint-Basile, Saint-Jacques et Verret seront retenus comme communautés urbaines dans la BDTC.

### Terre-Neuve

Les communautés suivantes devinrent des villes, le 1<sup>er</sup> janvier 1997, selon la Loi modifiée des municipalités C.25, 1996 : **Admiral's Beach; Anchor Point; Aquaforte; Baine Harbour; Baytona; Beachside; Bellburns; Bide Arm; Bird Cove; Biscay Bay; Bishop's Cove; Branch; Brent's Cove; Brighton; Bryant's Cove; Burlington; Cape Broyle; Cape St. George-Petit Jardin-Grand Jardin-De Grau-Marches Point-Loretto; Cartwright; Charlottetown; Coachman's Cove; Colinet; Comfort Cove-Newstead; Conche; Cormack; Cox's Cove; Crow Head; Daniel's Harbour; Davis Inlet; Duntara; English Harbour East; Fermeuse; Ferryland; Forteau; Fox Harbour; Frenchman's Cove; Gallants; Gaskiers-Point La Haye; Gillams; Glenburnie-Birchy Head-Shoal Brook; Goose Cove East; Grand Le Pierre; Great Harbour Deep; Hampden; Happy Adventure; Hermitage-Sandyville; Hopedale; Hughes Brook; Indian Bay (Parsons Point); Jackson's Arm; Keels; King's Cove; L'Anse-au-Clair; L'Anse-au-Loup; Lark Harbour; Leading Tickles West; Lewin's Cove; Little Bay; Little Bay East; Little Bay Islands; Lord's Cove; Lourdes; Lushes Bight-Beaumont-Beaumont North; Makkovik; Mary's Harbour; McIver's; Meadows; Melrose; Middle Arm, Green Bay; Miles Cove; Millertown; Ming's Bight; Morrisville; Nippers Harbour; Norris Point; North River; Pacquet; Parkers Cove; Parson's Pond; Pilley's Island; Pinware; Plate Cove East; Plate Cove West; Point au Gaul; Point Lance; Point May; Point of Bay; Pool's Cove; Port Anson; Port au Bras;**





Port Anson; Port au Bras; Port au Port East; Port Hope Simpson; Port Kirwan; Port Rexton; Portugal Cove South; Postville; Raleigh; Red Bay; Red Harbour; Reidville; Rencontre East; Renews-Cappahayden; Rigolet; Riverhead; River of Ponds; Rocky Harbour; Rushoon; St. Brendan's; St. Bride's; St. Joseph's; St. Lewis, St. Mary's, St. Pauls, St. Shotts, Sally's Cove, Sandringham, Sandy Cove; Seal Cove; Terra Nova; Tilt Cove; Tilting; Traytown; Trinity; Trout River; Westport; West St. Modeste; Whiteway; Winterland; Woodstock; Woody Point; and York Harbour.

The status of **Leading Tickles West** was changed from Community to Town 19 December 1996 under the *Municipalities Amendment Act, C.25, 1996*. Name changed to **Leading Tickles (Town)** 24 December 1997 by Nfld. Reg. 144/97 and OC97-735.

**Middle Arm, Green Bay** was changed from Community to Town 19 December 1996 under the *Municipalities Amendment Act, C.25, 1996*. Name changed to **Middle Arm (Town)** 17 July 1998 by Newfoundland Regulation 66/98 and the *Municipalities Act (OC 98-450)*.

---

### Ontario

Unless otherwise specified, all municipal changes took place on 1 January 1998. Changes and new names are listed by the County, District, or larger municipality of which they are a part.

#### Bruce County

**Tiverton** (Village) and **Bruce** (Municipal Township) amalgamated as **Bruce** (Municipal Township). **Mildmay** (Village) amalgamated with **Carrick** (Municipal Township) as **Mildmay-Carrick** (Municipal Township). **Teeswater** (Village) amalgamated with **Culross** (Municipal Township) as **Teeswater-Culross** (Municipal Township). Tiverton, Mildmay, and Teeswater will be retained on the CGNDB as Localities.

#### Elgin County

The Villages of **Port Burwell** and **Vienna** amalgamated with **Bayham** (Municipal Township) as **Bayham** (Municipal Township). The Villages of **Belmont** and **Port Stanley** amalgamated with **Yarmouth** (Municipal Township) as **Central Elgin** (Municipal Township). The Village of **Dutton** amalgamated with part of **Dunwich** (Municipal Township) as **Dutton/Dunwich**

**Port au Port East; Port Hope Simpson; Port Kirwan; Port Rexton; Portugal Cove South; Postville; Raleigh; Red Bay; Red Harbour; Reidville; Rencontre East; Renews-Cappahayden; Rigolet; Riverhead; River of Ponds; Rocky Harbour; Rushoon; St. Brendan's; St. Bride's; St. Joseph's; St. Lewis, St. Mary's, St. Pauls, St. Shotts, Sally's Cove, Sandringham, Sandy Cove; Seal Cove; Terra Nova; Tilt Cove; Tilting; Traytown; Trinity; Trout River; Westport; West St. Modeste; Whiteway; Winterland; Woodstock; Woody Point et York Harbour.**

Le statut de **Leading Tickles West** fut changé de communauté à ville, le 19 décembre 1996, selon la Loi modifiée sur les municipalités C.25, 1996. Le nom fut changé à **Leading Tickles (ville)**, le 24 décembre 1997, selon le règlement Nfld. Reg. 144/97 et le décret OC97-735.

**Middle Arm, Green Bay** fut changé de communauté à ville, le 19 décembre 1996, selon la Loi modifiée sur les municipalités C.25, 1996. Le nom fut changé à **Middle Arm (ville)**, le 17 juillet 1998, selon le règlement Nfld. Reg. 66/98 et la Loi sur les municipalités (OC 98-450).

---

### Ontario

À moins d'indication contraire, tous les changements de municipalités eurent lieu le 1<sup>er</sup> janvier 1998. Les changements et les nouveaux noms sont indiqués selon le comté, le district ou l'entité municipale dont ils font partie.

#### Comté de Bruce

**Tiverton** (village) et **Bruce** (canton municipal) se fusionnèrent pour former **Bruce** (canton municipal). **Mildmay** (village) se fusionna avec **Carrick** (canton municipal) pour former **Mildmay-Carrick** (canton municipal). **Teeswater** (village) se fusionna avec **Culross** (canton municipal) pour former **Teeswater-Culross** (canton municipal). Tiverton, Mildmay et Teeswater seront retenus comme localités dans la BDTC.

#### Comté d'Elgin

Les villages de **Port Burwell** et de **Vienna** se fusionnèrent avec **Bayham** (canton municipal) pour former **Bayham** (canton municipal). Les villages de **Belmont** et de **Port Stanley** se fusionnèrent avec **Yarmouth** (canton municipal) pour former **Central Elgin** (canton municipal). Le village de **Dutton** se fusionna avec une partie de **Dunwich** (canton municipal) pour former

(Municipal Township). **Springfield** (Village) amalgamated with **South Dorchester** (Municipal Township) and part of **Malahide** (Municipal Township) as **Malahide** (Municipal Township). The Police Village of **Shedden** was dissolved. **West Lorne** (Village) amalgamated with **Aldborough** (Municipal Township) as **West Elgin** (Municipal Township). Port Burwell, Vienna, Belmont, Port Stanley, Dutton, Springfield, Shedden, and West Lorne will be retained on the CGNDB as Localities.

### Essex County

The Municipal Townships of **Anderdon** and **Malden** amalgamated with the **Town** of **Amherstburg** as **Amherstburg** (Town). **Belle River** (Village) and **Maidstone** (Municipal Township) amalgamated as **Lakeshore** (Municipal Township).

### Frontenac County (former)

The Municipal County of **Frontenac** was dissolved. **Central Frontenac** (Municipal Township) was created by the amalgamation of the Municipal Townships of **Hinchinbrooke**, **Kennebec**, **Olden**, and **Oso**. The Municipal Townships of **Kingston** and **Pittsburgh** amalgamated with the **City** of **Kingston** as **Kingston** (City). **Howe Island** and **Wolfe Island** (Municipal Townships) amalgamated as **Frontenac Islands** (Municipal Township). The Municipal Townships of **Barrie**, **Clarendon and Miller**, and **Palmerston and North and South Canonto** amalgamated as **North Frontenac** (Municipal Township). **Bedford**, **Loughborough**, **Portland**, and **Storrington** (Municipal Townships) amalgamated as **South Frontenac** (Municipal Township).

### Grey County

**Artemisia** (Municipal Township) and **Flesherton** (Village) amalgamated as **Artemisia** (Municipal Township). **Thornbury** (Town) and **Collingwood** (Municipal Township) were amalgamated as **Blue Mountains** (Town). **Shallow Lake** (Village) and **Keppel** (Municipal Township) were amalgamated as **Keppel** (Municipal Township). **Priceville** (Police Village) was dissolved. **Flesherton**, **Thornbury**, **Shallow Lake**, and **Priceville** will be retained on the CGNDB as Localities.

### Hastings County

**Belleville** (City) and **Thurlow** (Municipal Township) amalgamated as **Belleville** (City). **Madoc** (Village) and **Huntingdon** (Municipal

**Dutton/Dunwich** (canton municipal). **Springfield** (village) se fusionna avec **South Dorchester** (canton municipal) et une partie de **Malahide** (canton municipal) pour former **Malahide** (canton municipal). Le village sous la gouverne de syndics **Shedden** fut dissous. **West Lorne** (village) se fusionna avec **Aldborough** (canton municipal) pour former **West Elgin** (canton municipal). Port Burwell, Vienna, Belmont, Port Stanley, Dutton, Springfield, Shedden et West Lorne seront retenus comme localités dans la BDTC.

### Comté d'Essex

Le canton municipal d'**Anderdon** et de **Malden** se fusionna avec la **ville** d'**Amherstburg** pour former **Amherstburg** (ville). **Belle River** (village) et **Maidstone** (canton municipal) se fusionnèrent pour former **Lakeshore** (canton municipal).

### Comté de Frontenac (anciennement)

Le comté municipal de **Frontenac** fut dissous. **Central Frontenac** (canton municipal) fut créé par la fusion des cantons municipaux de **Hinchinbrooke**, de **Kennebec**, d'**Oldenet** et d'**Oso**. Les cantons municipaux de **Kingston** et de **Pittsburgh** se fusionnèrent avec **Kingston** (grande ville). **Howe Island** et **Wolfe Island** (cantons municipaux) se fusionnèrent pour former **Frontenac Islands** (canton municipal). Les cantons municipaux de **Barrie**, **Clarendon and Miller**, et **Palmerston and North and South Canonto** se fusionnèrent pour former **North Frontenac** (canton municipal). **Bedford**, **Loughborough**, **Portland**, et **Storrington** (cantons municipaux) se fusionnèrent pour former **South Frontenac** (canton municipal).

### Comté de Grey

**Artemisia** (canton municipal) et **Flesherton** (village) se fusionnèrent pour former **Artemisia** (canton municipal). **Thornbury** (ville) et **Collingwood** (canton municipal) se fusionnèrent pour former **Blue Mountains** (ville). **Shallow Lake** (village) et **Keppel** (canton municipal) se fusionnèrent pour former **Keppel** (canton municipal). **Priceville** (village sous la gouverne de syndics) fut dissous. **Flesherton**, **Thornbury**, **Shallow Lake** et **Priceville** seront retenus comme localités dans la BDTC.

### Comté d'Hastings

**Belleville** (ville) et **Thurlow** (canton municipal) se fusionnèrent pour former **Belleville** (grande ville). **Madoc** (village) et **Huntingdon** (canton





Township) amalgamated as **Centre Hastings** (Municipal Township). **Marmora and Lake** (Municipal Township) amalgamated with **Deloro** (Village) as **Marmora and Lake** (Municipal Township). The City of **Trenton** amalgamated with the Municipal Townships of **Sidney** and **Murray** as **Quinte West** (City). **Stirling** (Village) and **Rawdon** (Municipal Township) amalgamated as **Stirling-Rawdon** (Municipal Township). The Municipal Townships of **Hungerford** and **Elzevir and Grimsthorpe** amalgamated with the Village of **Tweed** as **Tweed** (Municipality). **Madoc**, **Deloro**, and **Stirling** will be retained on the CGNDB as Localities.

#### **Kenora District**

**Dryden** (Town) amalgamated with **Barclay** (Municipal Township) as **Dryden** (City). The Town of **Sioux Lookout** amalgamated with the Geographic Townships of **Drayton**, **Jordan**, **Vermilion**, and **Vermilion Additional** as **Sioux Lookout** (Town). On 1 July 1998, the Municipal Townships of **Golden** and **Red Lake** amalgamated with parts of the Geographic Townships of **Baird** and **Heyson** as **Red Lake** (Town).

#### **Kent County (former)**

The Municipal County of **Kent** was dissolved when **Chatham-Kent** (Municipality) was created by the amalgamation of the City of **Chatham**, the Towns of **Blenheim**, **Bothwell**, **Dresden**, **Ridgetown**, **Tilbury**, and **Wallaceburg**, the Villages of **Erie Beach**, **Erieau**, **Highgate**, **Thamesville**, and **Wheatley**, and the Municipal Townships of **Camden**, **Chatham**, **Dover**, **Harwich**, **Howard**, **Orford**, **Raleigh**, **Romney**, **Tilbury East**, and **Zone**. **Merlin** (Police Village) was dissolved. **Chatham**, **Blenheim**, **Bothwell**, **Dresden**, **Ridgetown**, **Tilbury**, and **Wallaceburg**, **Erie Beach**, **Erieau**, **Highgate**, **Thamesville**, **Wheatley**, **Camden**, **Chatham**, **Dover**, **Harwich**, **Howard**, **Orford**, **Raleigh**, **Romney**, **Tilbury East**, **Zone**, and **Merlin** will be retained on the CGNDB as Localities.

#### **Lambton County**

**Dawn** and **Eupemia** (Municipal Townships) amalgamated as **Dawn-Euphemia** (Municipal Township). The Village of **Watford** and the Municipal Township of **Warwick** amalgamated as **Warwick** (Municipal Township). **Watford** will be retained on the CGNDB as a Locality.

#### **Lanark County**

The Municipal Townships of **Bathurst**, **North Burgess**, and **South Sherbrooke**

municipal) se fusionnèrent pour former **Centre Hastings** (canton municipal). **Marmora and Lake** (canton municipal) se fusionna avec **Deloro** (village) pour former **Marmora and Lake** (canton municipal). La grande ville de **Trenton** se fusionna avec les cantons municipaux de **Sidney** et **Murray** pour former **Quinte West** (grande ville). **Stirling** (village) et **Rawdon** (canton municipal) se fusionnèrent pour former **Stirling-Rawdon** (canton municipal). Les cantons municipaux de **Hungerford** et **Elzevir and Grimsthorpe** se fusionnèrent avec le village de **Tweed** pour former **Tweed** (municipalité). **Madoc**, **Deloro**, et **Stirling** seront retenus dans la BDTC comme localités.

#### **District de Kenora**

**Dryden** (ville) se fusionna avec **Barclay** (canton municipal) pour former **Dryden** (grande ville). La ville de **Sioux Lookout** se fusionna avec les cantons géographiques de **Drayton**, **Jordan**, **Vermilion** et **Vermilion Additional** pour former **Sioux Lookout** (ville). Le 1<sup>er</sup> juillet 1998, les cantons municipaux de **Golden** et **Red Lake** se fusionnèrent avec des parties des cantons géographiques de **Baird** et **Heyson** pour former **Red Lake** (ville).

#### **Comté de Kent (anciennement)**

Le comté municipal de **Kent** fut dissous quand **Chatham-Kent** (municipalité) fut créée par la fusion de la grande ville de **Chatham**, des villes de **Blenheim**, **Bothwell**, **Dresden**, **Ridgetown**, **Tilbury** et **Wallaceburg**, des villages de **Erie Beach**, **Erieau**, **Highgate**, **Thamesville** et **Wheatley**, et des cantons municipaux de **Camden**, **Chatham**, **Dover**, **Harwich**, **Howard**, **Orford**, **Raleigh**, **Romney**, **Tilbury East** et de **Zone**. **Merlin** (village sous la gouverne de syndics) fut dissous. **Chatham**, **Blenheim**, **Bothwell**, **Dresden**, **Ridgetown**, **Tilbury**, **Wallaceburg**, **Erie Beach**, **Erieau**, **Highgate**, **Thamesville**, **Wheatley**, **Camden**, **Chatham**, **Dover**, **Harwich**, **Howard**, **Orford**, **Raleigh**, **Romney**, **Tilbury East**, **Zone** et **Merlin** seront retenus dans la BDTC comme localités.

#### **Comté de Lambton**

**Dawn** et **Euphemia** (cantons municipaux) se fusionnèrent pour former **Dawn-Euphemia** (canton municipal). Le village de **Watford** et le canton municipal de **Warwick** se fusionnèrent pour former **Warwick** (canton municipal). **Watford** sera retenu dans la BDTC comme localité.

#### **Comté de Lanark**

Les cantons municipaux de **Bathurst**, **North Burgess** et **South Sherbrooke** se fusionnèrent



amalgamated as **Bathurst Burgess Sherbrooke** (Municipal Township). **Drummond** and **North Elmsley** (Municipal Townships) became **Drummond/North Elmsley** (Municipal Township). The Town of **Almonte** and the Municipal Townships of **Pakenham** and **Ramsay** amalgamated as the Town of **Mississippi Mills**. Almonte will be retained on the CGNDB as a Locality.

**Leeds and Grenville, United Counties of Merrickville** (Village) and **Wolford** (Municipal Township) amalgamated as **Merrickville-Wolford** (Village). **Kemptville** (Town) and **Oxford-on-Rideau** and **South Gower** (Municipal Townships) amalgamated as **North Grenville** (Municipal Township). **Newboro'** (Village) and **Bastard** and **South Burgess**, **North Crosby**, **South Crosby**, and **South Elmsley** (Municipal Townships) amalgamated as **Rideau Lakes** (Municipal Township). Merrickville, Kemptville, and Newboro will appear in the CGNDB as Localities.

#### **Lennox and Addington County**

**Addington Highlands** (Municipal Township) was created by the amalgamation of the Municipal Townships of **Denbigh**, **Abinger** and **Ashby**, **Kaladar**, **Anglesea**, and **Effingham**. The Town of **Napanee** amalgamated with the Municipal Townships of **Adolphustown**, **North Fredericksburgh**, **South Fredericksburgh**, and **Richmond** as **Greater Napanee** (Town). **Bath** (Village) amalgamated with the Municipal Townships of **Amherst Island** and **Sheffield** as **Loyalist** (Municipal Township). **Stone Mills** (Municipal Township) was created when **Newburgh** (Village) and **Camden East** and **Sheffield** (Municipal Townships) amalgamated. Napanee, Bath, and Newburgh will appear in the CGNDB as Localities.

#### **Manitoulin District**

The Municipal Township of **Burpee** and the Geographic Township of **Mills** amalgamated as **Burpee and Mills** (Municipal Township). **Little Current** (Town), **Howland** (Municipal Township), and all islands not attached to other municipalities around Manitoulin Island amalgamated as **Northeast Manitoulin and The Islands** (Town). The Municipal Townships of **Carnarvon** and **Sandfield** amalgamated with the Geographic Township of **Campbell** as **Central Manitoulin** (Municipal Township). Little Current will be retained on the CGNDB as a Locality.

pour former **Bathurst Burgess Sherbrooke** (canton municipal). **Drummond** et **North Elmsley** (cantons municipaux) devinrent **Drummond/North Elmsley** (canton municipal). La ville d'**Almonte** et les cantons municipaux de **Pakenham** et **Ramsay** se fusionnèrent pour former la ville de **Mississippi Mills**. Almonte sera retenu dans la BDTC comme localité.

#### **Comtés unis de Leeds et Grenville**

**Merrickville** (village) et **Wolford** (canton municipal) se fusionnèrent pour former **Merrickville-Wolford** (village). **Kemptville** (ville) et **Oxford-on-Rideau** et **South Gower** (cantons municipaux) se fusionnèrent pour former **North Grenville** (canton municipal). **Newboro'** (village) et **Bastard** et **South Burgess**, **North Crosby**, **South Crosby** et **South Elmsley** (cantons municipaux) se fusionnèrent pour former **Rideau Lakes** (canton municipal). Merrickville, Kemptville, and Newboro seront retenus dans la BDTC comme localités.

#### **Comté de Lennox et Addington**

**Addington Highlands** (canton municipal) fut créé par la fusion des cantons municipaux de **Denbigh**, **Abinger** et **Ashby**, **Kaladar**, **Anglesea** et **Effingham**. La ville de **Napanee** se fusionna avec les cantons municipaux de **Adolphustown**, **North Fredericksburgh**, **South Fredericksburgh**, et **Richmond** pour former **Greater Napanee** (ville). **Bath** (village) se fusionna avec les cantons municipaux de **Amherst Island** et **Sheffield** pour former **Loyalist** (canton municipal). **Stone Mills** (canton municipal) fut créé lorsque **Newburgh** (village) et **Camden East** et **Sheffield** (cantons municipaux) se fusionnèrent. Napanee, Bath et Newburgh seront retenus dans la BDTC comme localités.

#### **District de Manitoulin**

Le canton municipal de **Burpee** et le canton géographique de **Mills** se fusionnèrent pour former **Burpee et Mills** (canton municipal). **Little Current** (ville), **Howland** (canton municipal) et toutes les îles n'appartenant pas à une structure administrative aux alentours de Manitoulin Island se fusionnèrent pour former **Northeast Manitoulin and The Islands** (ville). Les cantons municipaux de **Carnarvon** et **Sandfield** se fusionnèrent avec le canton géographique de **Campbell** pour former **Central Manitoulin** (canton municipal). Little Current sera retenu dans la BDTC comme localité.





### **Metropolitan Toronto (former)**

**Metropolitan Toronto** (Regional Municipality) was dissolved and replaced by the new City of **Toronto** created by the amalgamation of the Borough of **East York** and the Cities of **Etobicoke**, **East York**, **North York**, **Toronto**, and **Scarborough**.

### **Middlesex County**

The Police Villages of **Delaware**, **Ilderton**, and **Komoka** were dissolved. The Municipal Townships of **Delaware**, **Lobo**, and **London** amalgamated as **Middlesex Centre** (Municipal Township). **Delaware**, **Ilderton**, and **Komoka** will be retained on the CGNDB as Localities.

### **Nipissing District**

**Temagami** (Municipal Township) amalgamated with the Geographic Townships of **Askin**, **Aston**, **Banting**, **Belfast**, **Best**, **Briggs**, **Canton**, **Cassels**, **Chambers**, **Cynthia**, **Joan**, **Law**, **LeRoche**, **Milne**, **Olive**, **Phyllis**, **Riddell**, **Sisk**, **Torrington**, **Vogt**, and **Yates** and with parts of the Geographic Townships of **Clement** and **Scholes** as **Temagami** (Town). On 1 June 1998, **Airy** (Municipal Township) amalgamated with the Geographic Townships of **Dickens**, **Lyell**, **Murchison**, and **Sabine** as **South Algonquin** (Municipal Township).

### **Northumberland County**

**Campbellford** (Town) and **Seymour** (Municipal Township) amalgamated as **Campbellford/Seymour** (Town). **Trenton** (City) amalgamated with the Municipal Townships of **Murray** and **Sidney** as **Quinte West** (City). **Campbellford** and **Trenton** will be retained on the CGNDB as Localities.

### **Parry Sound District**

**Magnetawan** (Village) and **Chapman** (Municipal Township) amalgamated as **Magnetawan** (Municipal Township). On 1 July 1998, **Croft** (Geographic Township) amalgamated with **Magnetawan** (Municipal Township). Part of **Monteith** (Geographic Township) amalgamated with **McMurrich** (Municipal Township) as **McMurrich/Monteith** (Municipal Township). **Rosseau** (Village) amalgamated with **Christie**, **Foley**, and **Humphrey** (Municipal Townships) and the other part of **Monteith** (Geographic Township) as **Seguin** (Municipal Township). **Magnetawan** and **Rosseau** will appear as Localities on the CGNDB.

### **Toronto métropolitain (anciennement)**

**Metropolitan Toronto** (municipalité régionale) fut dissoute et remplacée par la nouvelle grande ville de **Toronto** créée par la fusion du bourg d'**East York** et des grandes villes de **Etobicoke**, **East York**, **North York**, **Toronto** et **Scarborough**.

### **Comté de Middlesex**

Les villages sous la gouverne de syndics de **Delaware**, **Ilderton** et **Komoka** furent dissous. Les cantons municipaux de **Delaware**, **Lobo** et **London** se fusionnèrent pour former **Middlesex Centre** (canton municipal). **Delaware**, **Ilderton** et **Komoka** seront retenus dans la BDTC comme localités.

### **District de Nipissing**

**Temagami** (canton municipal) se fusionna avec les cantons géographiques de **Askin**, **Aston**, **Banting**, **Belfast**, **Best**, **Briggs**, **Canton**, **Cassels**, **Chambers**, **Cynthia**, **Joan**, **Law**, **LeRoche**, **Milne**, **Olive**, **Phyllis**, **Riddell**, **Sisk**, **Torrington**, **Vogt** et **Yates** et avec des parties des cantons géographiques de **Clement** et **Scholes** pour former **Temagami** (ville). Le 1<sup>er</sup> juin 1998, **Airy** (canton municipal) se fusionna avec les cantons géographiques de **Dickens**, **Lyell**, **Murchison** et **Sabine** pour former **South Algonquin** (canton municipal).

### **Comté de Northumberland**

**Campbellford** (ville) et **Seymour** (canton municipal) se fusionnèrent pour former **Campbellford/Seymour** (ville). **Trenton** (grande ville) se fusionna avec les cantons municipaux de **Murray** et **Sidney** pour former **Quinte West** (grande ville). **Campbellford** et **Trenton** seront retenus dans la BDTC comme localités.

### **District de Parry Sound**

**Magnetawan** (village) et **Chapman** (canton municipal) se fusionnèrent pour former **Magnetawan** (canton municipal). Le 1<sup>er</sup> juillet 1998, **Croft** (canton géographique) se fusionna avec **Magnetawan** (canton municipal). Une partie de **Monteith** (canton géographique) se fusionna avec **McMurrich** (canton municipal) pour former **McMurrich/Monteith** (canton municipal). **Rosseau** (village) se fusionna avec **Christie**, **Foley** et **Humphrey** (cantons municipaux) et une partie de **Monteith** (canton géographique) pour former **Seguin** (canton municipal). **Magnetawan** et **Rosseau** seront retenus comme localités dans la BDTC.

**Perth County**

**Dublin** (Police Village) was dissolved. **Listowel** (Town) amalgamated with **Elma** and **Wallace** (Municipal Townships) as **North Perth** (Town). **Milverton** (Village) amalgamated with the Municipal Townships of **Ellice**, **Mornington**, **North Easthope**, and **South Easthope** as **Perth East** (Municipal Township). **Perth South** (Municipal Township) was created by the amalgamation of the Municipal Townships of **Blanshard** and **Downie**. **Mitchell** (Town) amalgamated with **Fullarton**, **Hibbert**, and **Logan** (Municipal Townships) as **West Perth** (Municipal Township). **Dublin**, **Milverton**, and **Mitchell** will be retained on the CGNDB as Localities.

**Peterborough County**

**Norwood** (Village) and **Asphodel** (Municipal Township) amalgamated as **Asphodel-Norwood** (Municipal Township). The Municipal Townships of **Anstruther**, **Burleigh**, and **Chandos** amalgamated as **Burleigh-Anstruther-Chandos** (Municipal Township). **Millbrook** (Village) amalgamated with **Cavan** and **North Monaghan** (Municipal Townships) as **Cavan-Millbrook-North Monaghan** (Municipal Township). **Douro** and **Dummer** (Municipal Townships) amalgamated as **Douro-Dummer** (Municipal Township). **Cavendish**, **Galway**, and **Harvey** (Municipal Townships) amalgamated as **Galway-Cavendish and Harvey** (Municipal Township). **Havelock** (Village) and **Belmont and Methuen** (Municipal Township) amalgamated as **Havelock-Belmont-Methuen** (Municipal Township). **Otonabee** and **South Monaghan** (Municipal Townships) amalgamated as **Otonabee-South Monaghan** (Municipal Township). **Smith** and **Ennismore** (Municipal Townships) amalgamated as **Smith-Ennismore** (Municipal Township). **Norwood**, **Millbrook**, and **Havelock** will be retained as Localities on the CGNDB.

**Prescott and Russell, United Counties of Champlain** (Municipal Township) was created by the amalgamation of **Vankleek Hill** (Town), **L'Orignal** (Village), and **Longueuil and West Hawkesbury** (Municipal Townships). **Rockland** (Town) and **Clarence** (Municipal Township) amalgamated as **Clarence-Rockland** (City). **St. Isidore** (Village) amalgamated with **Caledonia**, **Cambridge**, and **South Plantagenet** (Municipal Townships) as **The Nation in English and La Nation in French**. **Vankleek Hill**, **L'Orignal**, **Rockland**, and **St. Isidore** will appear on the CGNDB as Localities.

**Comté de Perth**

**Dublin** (village sous la gouverne de syndics) fut dissous. **Listowel** (ville) se fusionna avec **Elma** et **Wallace** (cantons municipaux) pour former **North Perth** (ville). **Milverton** (village) se fusionna avec les cantons municipaux de **Ellice**, **Mornington**, **North Easthope** et **South Easthope** pour former **Perth East** (canton municipal). **Perth South** (canton municipal) fut créé suite à la fusion des cantons municipaux de **Blanshard** et **Downie**. **Mitchell** (ville) se fusionna avec **Fullarton**, **Hibbert** et **Logan** (cantons municipaux) pour former **West Perth** (canton municipal). **Dublin**, **Milverton** et **Mitchell** seront retenus dans la BDTC comme localités.

**Comté de Peterborough**

**Norwood** (village) et **Asphodel** (canton municipal) se fusionnèrent pour former **Asphodel-Norwood** (canton municipal). Les cantons municipaux de **Anstruther**, **Burleigh** et **Chandos** se fusionnèrent pour former **Burleigh-Anstruther-Chandos** (canton municipal). **Millbrook** (village) se fusionna avec **Cavan** et **North Monaghan** (cantons municipaux) se fusionnèrent pour former **Cavan-Millbrook-North Monaghan** (canton municipal). **Douro** et **Dummer** (cantons municipaux) se fusionnèrent pour former **Douro-Dummer** (canton municipal). **Cavendish**, **Galway** et **Harvey** (cantons municipaux) se fusionnèrent pour former **Galway-Cavendish and Harvey** (canton municipal). **Havelock** (village) et **Belmont and Methuen** (canton municipal) se fusionnèrent pour former **Havelock-Belmont-Methuen** (canton municipal). **Otonabee** et **South Monaghan** (cantons municipaux) se fusionnèrent pour former **Otonabee-South Monaghan** (canton municipal). **Smith** et **Ennismore** (cantons municipaux) se fusionnèrent pour former **Smith-Ennismore** (canton municipal). **Norwood**, **Millbrook** et **Havelock** seront retenus dans la BDTC comme localités.

**Comtés unis de Prescott et Russell**

**Champlain** (canton municipal) fut créé par la fusion de **Vankleek Hill** (ville), **L'Orignal** (village), et **Longueuil et West Hawkesbury** (cantons municipaux). **Rockland** (ville) et **Clarence** (canton municipal) se fusionnèrent pour former **Clarence-Rockland** (grande ville). **St. Isidore** (village) se fusionna avec **Caledonia**, **Cambridge** et **South Plantagenet** (cantons municipaux) pour former **The Nation en anglais et La Nation en français**. **Vankleek Hill**, **L'Orignal**, **Rockland** et **St. Isidore** seront retenus dans la BDTC comme localités.





### **Prince Edward County**

Prince Edward (County) amalgamated with the Villages of **Picton** and **Wellington**, and the Municipal Townships of **Ameliasburgh**, **Athol**, **Hallowell**, **Hillier**, **North Marysburgh**, **South Marysburgh**, and **Sophiasburgh** as **Prince Edward** (County). Picton and Wellington will be retained on the CGNDB as Localities.

### **Rainy River District**

McCrosson and Tovell (Municipal Township) and Morson (Municipal Township) amalgamated as **Lake of the Woods** (Municipal Township).

### **Renfrew County**

Bagot and Blythfield (Municipal Township) and Brougham (Municipal Township) amalgamated as **Bagot, Blythfield and Brougham** (Municipal Township). **Braeside** (Village) and **McNab** (Municipal Township) amalgamated as **McNab/Braeside** (Municipal Township). **Petawawa** (Village) and **Petawawa** (Municipal Township) amalgamated as **Petawawa** (Town) on 1 January 1997.

### **Stormont, Dundas and Glengarry, United Counties of**

The Police Villages of **Avonmore**, **Monkland**, and **Moose Creek** were dissolved. **North Dundas** (Municipal Township) was created by the amalgamation of the Villages of **Chesterville** and **Winchester** and the Municipal Townships of **Mountain** and **Winchester**. **Alexandria** (Town), **Maxville** (Village), and **Kenyon and Lochiel** (Municipal Townships) amalgamated as **North Glengarry** (Municipal Township). **Finch** (Village) and the Municipal Townships of **Finch** and **Roxborough** amalgamated as **North Stormont** (Municipal Township). **South Dundas** (Municipal Township) was created when the Villages of **Iroquois** and **Morrisburg** and the Municipal Townships of **Matilda** and **Williamsburgh** were amalgamated. **Lancaster** (Village) amalgamated with **Charlottenburgh** and **Lancaster** (Municipal Townships) as **South Glengarry** (Municipal Township). The Municipal Townships of **Osnabruck** and **Cornwall** amalgamated as **South Stormont** (Municipal Township). **Avonmore**, **Monkland**, **Moose Creek**, **Chesterville**, **Winchester**, **Alexandria**, **Maxville**, **Finch**, **Iroquois**, and **Morrisburg** will be retained on the CGNDB as Localities.

### **Sudbury District**

**Espanola** (Town) increased its size when it annexed the Geographic Township of **Merritt**. **Nairn** (Municipal Township) annexed the

### **Comté de Prince Edward**

Prince Edward (comté) se fusionna avec les villages de **Picton** et **Wellington** et les cantons municipaux de **Ameliasburgh**, **Athol**, **Hallowell**, **Hillier**, **North Marysburgh**, **South Marysburgh** et **Sophiasburgh** pour former **Prince Edward** (comté). Picton et Wellington seront retenus dans la BDTC comme localités.

### **District de Rainy River**

McCrosson et Tovell (canton municipal) et Morson (canton municipal) se fusionnèrent pour former **Lake of the Woods** (canton municipal).

### **Comté de Renfrew**

Bagot et Blythfield (canton municipal) et Brougham (canton municipal) se fusionnèrent pour former **Bagot, Blythfield and Brougham** (canton municipal). **Braeside** (village) et **McNab** (canton municipal) se fusionnèrent pour former **McNab/Braeside** (canton municipal). **Petawawa** (village) et **Petawawa** (canton municipal) se fusionnèrent pour former **Petawawa** (ville), le 1<sup>er</sup> janvier 1997.

### **Comtés unis de Stormont, Dundas et Glengarry**

Les villages sous la gouverne de syndics **Avonmore**, **Monkland** et **Moose Creek** furent dissous. **North Dundas** (canton municipal) fut créé par la fusion des villages de **Chesterville** et **Winchester** et des cantons municipaux de **Mountain** et **Winchester**. **Alexandria** (ville), **Maxville** (village), et **Kenyon et Lochiel** (cantons municipaux) se fusionnèrent pour former **North Glengarry** (canton municipal). **Finch** (village) et les cantons de **Finch** et **Roxborough** se fusionnèrent pour former **North Stormont** (canton municipal). **South Dundas** (canton municipal) fut créé lorsque les villages de **Iroquois** et **Morrisburg** et les cantons municipaux de **Matilda** et **Williamsburgh** se fusionnèrent. **Lancaster** (village) se fusionna avec **Charlottenburgh** et **Lancaster** (cantons municipaux) pour former **South Glengarry** (canton municipal). Les cantons municipaux d'**Osnabruck** et **Cornwall** se fusionnèrent pour former **South Stormont** (canton municipal). **Avonmore**, **Monkland**, **Moose Creek**, **Chesterville**, **Winchester**, **Alexandria**, **Maxville**, **Finch**, **Iroquois** et **Morrisburg** seront retenus comme localités dans la BDTC.

### **District de Sudbury**

**Espanola** (ville) annexa une partie du canton géographique de **Merritt**. **Nairn** (canton municipal) annexa le canton géographique de

Geographic Township of Hyman and became **Nairn and Hyman** (Municipal Township). **Massey and Webbwood** (Towns), **The Spanish River** (Municipal Township), and **Gough, McKinnon, Shakespeare, and Tennyson** (Geographic Townships) amalgamated as **Sables-Spanish River** (Municipal Township).

### Thunder Bay District

**Greenstone** (Municipality) was created by the amalgamation of **Geraldton and Longlac** (Towns), **Beardmore and Nakina** (Municipal Townships), and **Kilkenny, Kitto, Dorothea, Sandra, Irwin, Vincent, Walters, Leduc, Lapierre, Legault, Colter, Hipel, Lindsley, Kirby, Errington, Fulford, Salsberg, Ashmore, McQuesten, Houck, Croll, Oakes, Daley, and Abrey** (Geographic Townships). The Municipal Townships of **Oliver and Paipoonge** amalgamated as **Oliver Paipoonge** (Municipal Township). **Geraldton and Longlac** will be retained on the CGNDB as Localities.

### Timiskaming District

**Coleman** (Municipal Township) increased its area by annexing parts of the Geographic Townships of **Coleman and Gillies Limit**.

### Wellington County

**Erin** (Village) and **Erin** (Municipal Township) amalgamated as **Erin** (Town). **Drayton** (Village) amalgamated with **Peel** (Municipal Township) as **Mapleton** (Municipal Township). **Drayton** will be retained on the CGNDB as a Locality.

### Saskatchewan

The Villages of **Bounty, West Bend, and Wroxton** were dissolved on 26 November 1997, 14 May 1997, and 17 January 1997, respectively, but will be retained on the CGNDB as Localities.

The following Villages became Hamlets: **Carragana** on 25 March 1998, while **Madison** and **Salvador** both changed on 4 February 1998.

The following Organized Hamlets became Hamlets: **Bateman** on 12 December 1996, **Lacadena** and **Reward** on 31 December 1997, and **Tyner** on 1 January 1996.

The Northern Hamlets of **Stanley Mission** and **Wollaston Lake** became Northern Settlements on 1 May 1997 and 1 January 1996, respectively.

### Endnote / Note

1 Kathleen O'Brien, CPCGN Secretariat / Secrétariat du CPCNG, Ottawa.

**Hyman** et devint **Nairn and Hyman** (Canton municipal). **Massey et Webbwood** (villes), **The Spanish River** (canton municipal) et **Gough, McKinnon, Shakespeare, et Tennyson** (cantons géographiques) se fusionnèrent pour former **Sables-Spanish River** (canton municipal).

### District de Thunder Bay

**Greenstone** (municipalité) fut créée suite à la fusion de **Geraldton et Longlac** (villes), **Beardmore et Nakina** (cantons municipaux), et **Kilkenny, Kitto, Dorothea, Sandra, Irwin, Vincent, Walters, Leduc, Lapierre, Legault, Colter, Hipel, Lindsley, Kirby, Errington, Fulford, Salsberg, Ashmore, McQuesten, Houck, Croll, Oakes, Daley, et Abrey** (cantons géographiques). Les cantons municipaux de **Oliver et Paipoonge** se fusionnèrent pour former **Oliver Paipoonge** (canton municipal). **Geraldton et Longlac** seront retenus dans la BDTC comme localités.

### District de Timiskaming

**Coleman** (canton municipal) annexa des parties des cantons géographiques de **Coleman et Gillies Limit**.

### Comté de Wellington

**Erin** (village) et **Erin** (canton municipal) se fusionnèrent pour former **Erin** (ville). **Drayton** (village) se fusionna avec **Peel** (canton municipal) pour former **Mapleton** (canton municipal). **Drayton** sera retenu dans la BDTC comme localité.

### Saskatchewan

Les villages de **Bounty, West Bend et Wroxton** furent dissous le 26 novembre 1997, le 14 mai 1997 et le 17 janvier 1997, selon cet ordre. Ils seront retenus dans la BDTC comme localités.

Les villages suivants devinrent des hameaux : **Carragana**, le 25 mars 1998; **Madison** et **Salvador** changèrent le 4 février 1998.

Les hameaux organisés suivants devinrent des hameaux : **Bateman**, le 12 décembre 1996; **Lacadena** et **Reward**, le 31 décembre 1997; et **Tyner**, le 1<sup>er</sup> janvier 1996.

Les hameaux nordiques de **Stanley Mission** et **Wollaston Lake** devinrent des établissements nordiques, le 1<sup>er</sup> mai 1997 et le 1<sup>er</sup> janvier 1996, selon cet ordre.



## New Brunswick data base / Base de données du Nouveau-Brunswick

The screen below, from the New Brunswick Geographical Names Dataset, shows the type of information contained in that province's data base. Most fields reflect the information shown on the CGNDB. The Narrative field is an extra field shown on this screen

L'écran ci-dessous, qui provient de la base de données du Nouveau-Brunswick, montre le genre de renseignements contenus dans cette dernière. La majorité des zones indiquées reflètent les données de la BDTC. La zone <<narrative>> (ou données d'origine) est une zone supplémentaire montrée sur cet écran.

NB GEOGRAPHICAL NAMES DATASET			
Status Codes: A = Approved, B = Rescinded, C = Unofficial			
Unique Key:	DAVTW		
Name Key:	Quispamsis		
Status Code:	A2		
Generic Code:	2	Border Flag:	<input type="checkbox"/>
Generic Term:	Town (2)	Park Code:	<input type="checkbox"/>
Obscure Generic:	Y	Meeting Date:	
Region:	13	Century Code:	
Decision Date:	82-12-22	Change Date:	98-01-01
Century Code:	19		
Latitude:	452641	Head Latitude:	
Longitude:	655629	Head Longitude:	
Datum Code:	1	Head Datum code:	
Gazetteer Map:	021H05	Head Map:	
Cross Reference:			
Location 1:	Kings		
Location 2:	Rothsay		
Narrative:	<p>Named by railway officials; Maliseet Indian for "little lake" (18th Report). Quispamsis (village) was approved 3 Oct. 1933 on 21H/5. Incorporated as a town 22 Dec. 1982. Comprises the communities of Hammond River, Otty Glen, Model Farm, Blairs, Ritchie Lake, Stoneycroft and the locality of Meenans Corner. Amalgamated with the Village of Gondola Point and adjacent areas, on Order in Council 97-369, authorizing New Brunswick Regulation 97-41 to amend New Brunswick Regulation 85-6 under the Municipalities Act. This amalgamation was approved by decision on 1 May 1997, effective 1 January 1998.</p>		