

MS.

CANADA
DEPARTMENT OF MINES AND TECHNICAL SURVEYS
MINES BRANCH

Dept. Mines & Technical Surveys
M.T.S. 119
FEB 19 1954
LIBRARY
OTTAWA, CANADA.

METHODS OF ANALYSIS OF IRON AND STEEL USED AT THE MINES BRANCH LABORATORIES

compiled by

J. S. McCREE

MINERAL DRESSING AND PROCESS METALLURGY DIVISION



~~Price, 50 cents~~

Price, 50 cents

Revision of Memorandum Series No. 119

1953

CANADA
DEPARTMENT OF MINES AND TECHNICAL SURVEYS
MINES BRANCH

**METHODS OF ANALYSIS OF IRON AND
STEEL USED AT THE MINES
BRANCH LABORATORIES**

compiled by

J. S. McCREE

MINERAL DRESSING AND PROCESS METALLURGY DIVISION



Price 25 cents

Revision of Memorandum Series No. 119

1953

CONTENTS

	<u>Page</u>
Determination of Carbon	1
Determination of Manganese in Cast Iron and Plain Carbon Steels	5
Determination of Silicon	7
Determination of Sulphur	7
Determination of Phosphorus	11
Determination of Nickel	13
Determination of Chromium Steels	16
Determination of Molybdenum in Steel	18
Determination of Vanadium in Steel	20
Determination of Tungsten in Steel	21
Determination of Titanium in Steel	22
Determination of Copper in Steel	23
Determination of Columbium in Steel	24
Determination of Aluminum in Cast Iron and Steel	25
Determination of Cerium in Cast Iron and Steel ..	26
Determination of Tin (Low Chromium Steels)	28
Determination of Tin in Steel (Polarographic).....	29
Determination of Tantalum in Stainless Steels	29
Determination of Selenium	30
Determination of Magnesium in Cast Irons	31
Determination of Nitrogen in Steel	34
Determination of Nitrogen as Aluminum Nitride in Steels ,	36
Determination of Boron in Steel	36
Determination of Nickel and Copper in Steel	40
Useful Factors	41
Bibliography	42

ILLUSTRATIONS

Figure 1 - Dietert Carbon Determinator	2
Figure 2 - Leco Volumetric Carbon Determinator	2
Figure 3 - Leco Conductometric Carbon Determinator	4
Figure 4 - Carbon Trains	4
Figure 5 - Sulphur Determinator	8
Figure 6 - Detail of Exit Tube	8
Figure 7 - Brass Adaptor for Sulphur Furnace	10
Figure 8 - HC Cathode-Plan	33
Figure 9 - Nitrogen Still	35
Figure 10- Aluminum Nitride Still	35
Figure 11- Apparatus for Boron Determination ..	37

METHODS OF ANALYSIS OF IRON AND STEEL
USED AT THE MINES BRANCH LABORATORIES

Compiled by

J. S. McCree
Mineral Dressing and Process Metallurgy Division

DETERMINATION OF CARBON

Dietert and Leco Method

Weigh 1/4 gm or one gm sample, depending upon amount of C, into a pre-ignited boat.

Add one strip of "Dualaccelerator" on top.

Place in furnace at temperature of 2500°F.

Pre-heat for 1 to 2 minutes, then pass oxygen at the rate of 1-1/2 litres/minute.

(See Figure 4).

Solution for Dietert

Absorption

820 gms KOH.
1200 ccs H₂O

Aspirator Bottle

500 ccs H₂O
3 ccs H₂SO₄

Tint with methyl red

Solutions for Leco

Absorption

750 gms KOH
1500 ccs H₂O

Levelling Bottles

30 ccs H₂SO₄
1500 ccs H₂O
9 ccs Leconal wetting agent.

Pour a small quantity of this solution into a beaker. Mix with methyl orange until a dense red colour is obtained. Filter and transfer filtrate to main solution. Use 750 ccs in working burette and 750 ccs in nul burette.



Figure 1—Dietert Carbon Determinator

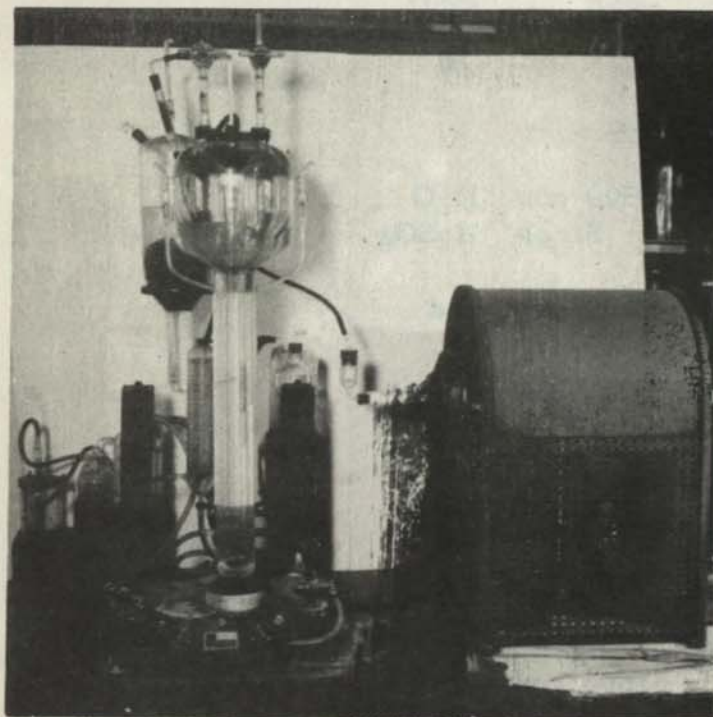

Figure 2—Leco Volumetric Carbon Determinator

Umpire Method

Weigh 2.727 gms sample and place in a pre-ignited boat containing bed of alfrax.

Place in furnace temperature 2400° F and pass oxygen for 15 minutes.

For stainless steels add a suitable accelerator.

(See Figure 4).

Determination of Graphite Carbon

Weigh 0.2 to 1 gm sample into a 250 cc beaker.

Add 50 ccs (1 to 3) HNO₃ and heat for 15 minutes.

Filter through ignited asbestos Gooch.

Wash with cold water, then 2% HCl and finally with hot water.

Dry for 2 hours in drying oven 105°C.

Place in combustion boat and continue as for C.

Leco Conductometric Carbon Method (0-0.04%)

1. Make up 9 litres of barium hydroxide solution.

9 gms Ba(OH)₂/9 litres

1 gm gelatine

5 ccs 2 ethyl hexanol.

2. Turn on constant temperature circulating pump. Turn on Wheatstone bridge.
3. Turn on oxygen so that there is a pressure of 4 units on the manometer on the main stand.
4. Fill the 'tempering jars' with barium hydroxide. When temperature of circulating pump is constant, fill standard cell to mark.
5. Fill working cell to level. Drain off excess and see that drain pipe is clear.
6. Weigh 1/4 to 1 gm sample into a pre-ignited boat. Add accelerator and cover. (DO NOT TOUCH BOAT OR COVER WITH FINGERS. USE FORCEPS OR TONGS). Place covered boat in mouth of tube and push it in with heat deflector and cork firmly.
7. Turn on oxygen. Then open tap at bottom of manometer. (Oxygen pressure should be NOT MORE THAN 40.) Circulate oxygen through working cell for a timed 3 minutes, adjusting the zero of the oscilloscope.

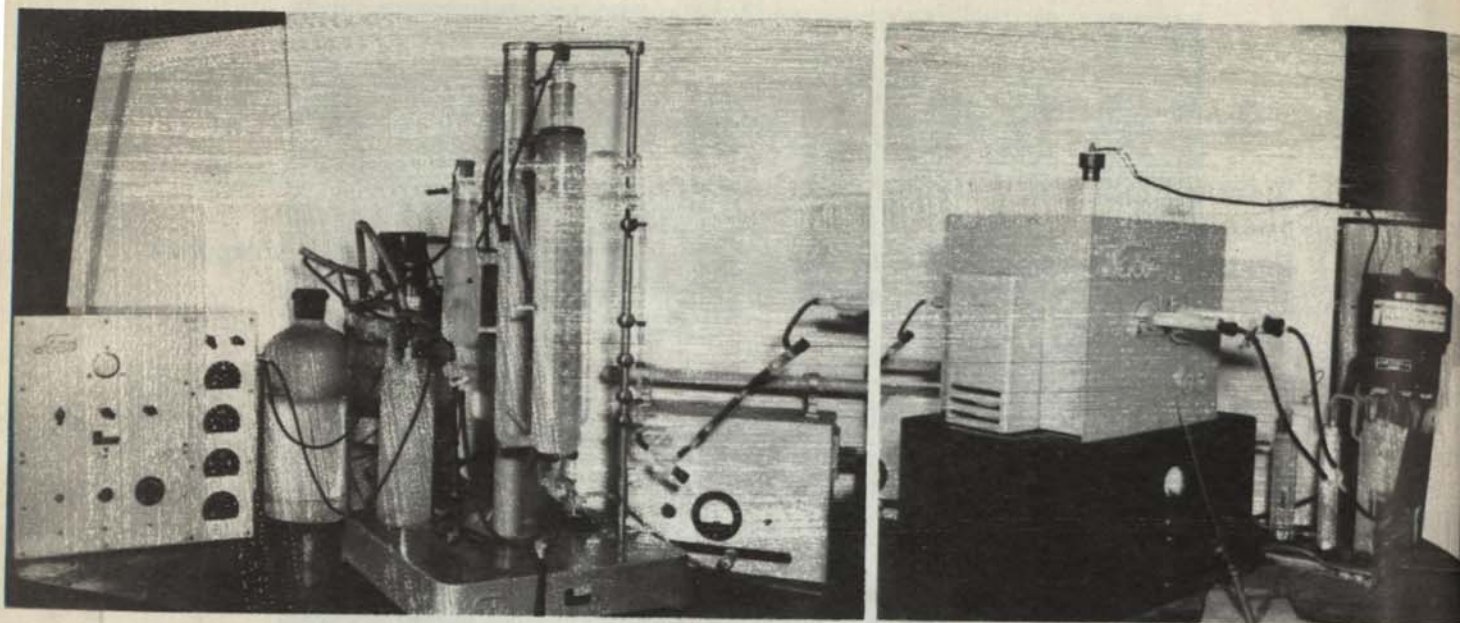
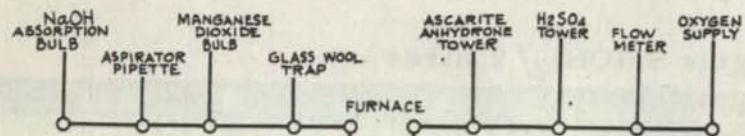
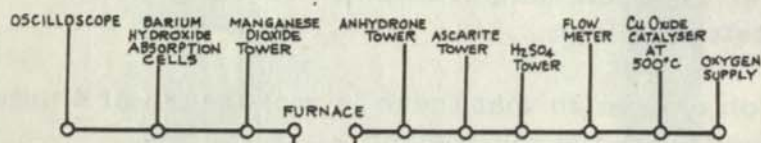

Figure 3—Leco Conductometric Carbon Determinator



DIERT & LECO VOLUMETRIC METHOD



LECO CONDUCTOMETRIC METHOD



UMPIRE METHOD

Figure 4—Carbon Trains

8. At the end of 3 minutes turn off tap leading to working cell, turn off oxygen, remove cork and push sample into hot zone. This should be done quickly. Replace cork and pre-heat for a timed 1/2 minute. Turn on oxygen and open tap to working cell. Start stop watch and adjust Wheatstone bridge to keep oscilloscope at zero. Take readings at 3, 5, 7, 10 and 12 minutes. Use 10-minute reading as final reading.
9. Drain working cell while oxygen is still flowing. Close tap entering working cell. Turn off oxygen. Remove cork and remove boat. Start at 5 again.
Standard cell is only filled at the beginning of a run.

To Construct Curve

Run 3 samples of U. S. Bureau of Standards Steel No. 131 (C-0.0028%) and 3 samples of U. S. Bureau of Standards Steel No. 55b (C-0.010%).

This must be done each day.

DETERMINATION OF MANGANESE IN CAST IRONS AND PLAIN CARBON STEELS

Weigh 0.25 gm sample into a 500 cc conical flask.
Add 30 ccs "manganese acid".
Heat until in solution and add 100 ccs H₂O.
Add 10 ccs AgNO₃ and boil.
Add 10 ccs saturated solution of ammonium persulphate.
Boil for one minute only. Cool quickly and add 75 ccs H₂O.
Titrate rapidly with standard sodium arsenite solution to a light yellow colour.

Stainless Steel

Weigh 0.25 gm sample into a 500 cc conical flask.
Add 5 ccs HNO₃ and 10 ccs HCl and boil until in solution.
Add 30 ccs HClO₄ and take to fumes.
Add 1 to 4 gms sodium chloride a pinch at a time to volatilize Cr.
Take almost to dryness after all Cr is volatilized.
Cool and add 30 ccs "manganese acid" and proceed as above.

"Manganese Acid"

1050 ccs H₂O
250 ccs H₃PO₄
200 ccs H₂SO₄
500 ccs HNO₃

Place water in a large flask, add H₂SO₄ and then the other acids.
Mix well and cool.
Use exactly 30 ccs per determination.

AgNO₃ for Manganese

Dissolve 25.0 gms AgNO₃ in sufficient water and dilute to 2 litres.

Standard Sodium Arsenite

Dissolve 1.93 gms sodium arsenite in sufficient water and dilute to 2 litres.
Standardize using above methods with a standard steel.

Manganese Steel

Weigh 0.25 gm sample into a 250 cc beaker.
Add 30 ccs (1.3) HNO₃ and boil.
If Cr is present, use 30 ccs (1.3) H₂SO₄ instead.
Add sodium bismuthate a pinch at a time until MnO₂ precipitates.
Boil one minute.
Add ferrous ammonium sulphate crystals to clear. See that there is no manganese adhering to the sides of the beaker.
Boil and cool to room temperature.
Add 50 ccs water and 2 gms sodium bismuthate.
Stir thoroughly and vigorously for a timed 2 minutes.
Add 50 ccs 3% HNO₃ and filter immediately through a prepared Gooch crucible using ignited asbestos pad.
Wash well with 3% HNO₃.
Add a measured excess of standard ferrous ammonium sulphate solution and titrate with standard potassium permanganate solution to pink end point.

Fe value of KMnO₄ x 0.1968 = Bismuthate Manganese
value of KMnO₄

Standard Ferrous Ammonium Sulphate

140 gms Fe AmSO₄
100 ccs H₂SO₄

Dissolve the salt in sufficient water. Add the acid and make up to 2 litres with water.

Standard Potassium Permanganate

3.16 gms KMnO_4 /litre

Standardize the KMnO_4 against 0.7023 gms of ferrous ammonium sulphate or standard oxalate.

Example

20 ccs of standard $\text{Fe AmSO}_4 = 20.9$ ccs KMnO_4

Titration required 10 ccs KMnO_4

$(20.9 - 10) \times$ bismuthate value of $\text{KMnO}_4 \times 4 \times 100 = \% \text{Mn}$

$(20.9 - 10) \times 0.00106 \times 4 \times 100 = 4.60\% \text{ Mn}$

DETERMINATION OF SILICON

Pig Iron and Plain Carbon Steel

Weigh 2 gms sample into a 250 cc beaker.

Add 5 ccs HNO_3 .

Add 30 ccs HClO_4 .

Cover with watchglass and take to fumes.

Allow HClO_4 to reflux for 15 minutes. Do not allow to become pasty or solid.

Cool and dilute with 35 ccs H_2O . Swirl to mix.

Filter immediately and wash with water, then with 1:1 HCl and finally with water.

Transfer to crucible. Ignite and weigh.

$$\frac{\text{Wt.} \times 0.4672 \times 100}{2} = \text{Si}\%$$

Determination of Si in Alloy Steels

Weigh 2 gms sample into a 250 cc beaker.

Add 10 ccs HNO_3 and 15 ccs HCl .

When steel is dissolved add 30 ccs HClO_4 and complete as above.

DETERMINATION OF SULPHUR

Combustion

Weigh 1/2 to 1 gm sample into a combustion boat.

Add a few pellets of granulated tin, 20-mesh, or cover with one leaf of "Dualaccelerator" and cover with a porcelain or fireclay lid.

Have furnace at 2800°F . At this temperature it is preferable to use

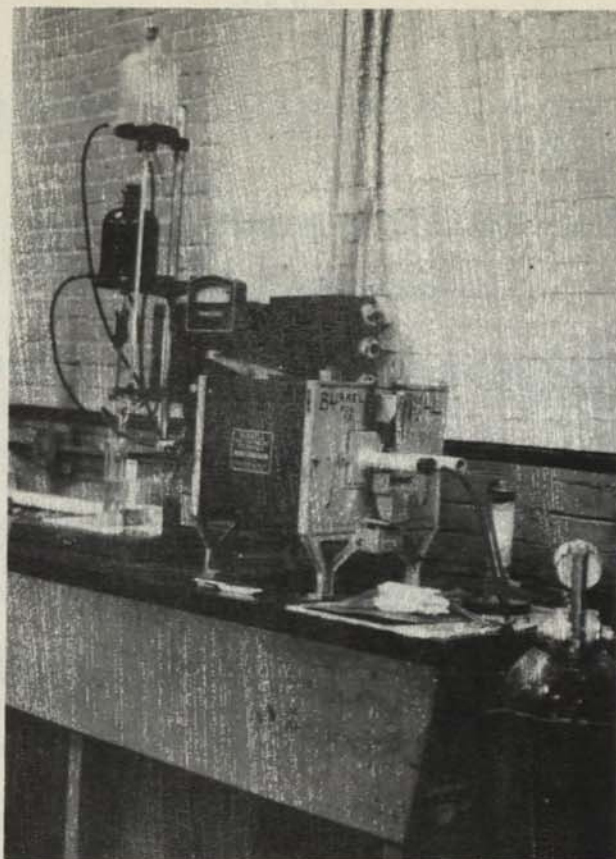

Figure 5—Sulphur Determinator

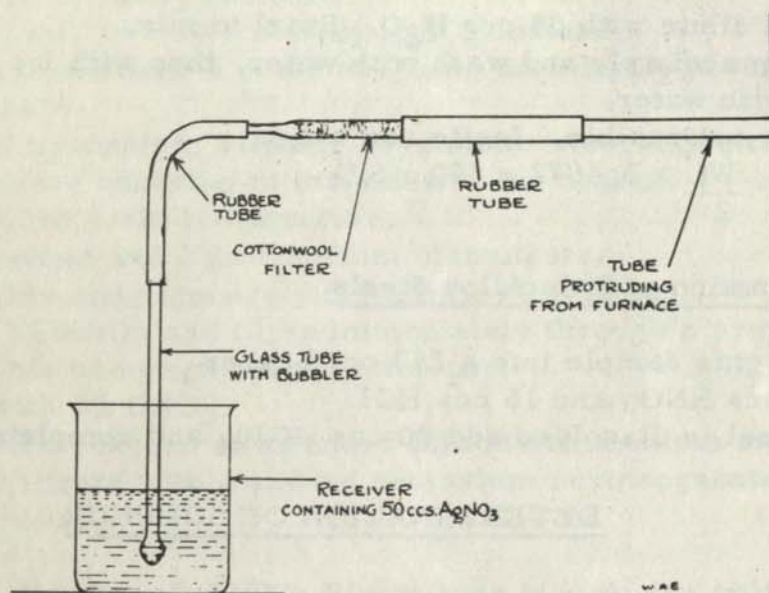

Figure 6—Detail of Exit Tube

brass adaptors shown in Figure 7 rather than rubber stoppers. Blow oxygen through for 15 minutes before starting a run. Rate of flow about 1-1/2 litres/minute.

Keep oxygen flowing from the time the sample is placed in the furnace until combustion is complete.

The oxides of sulphur pass through a "Cotton Wool" filter and bubble into 50 ccs silver nitrate and produce free nitric acid. This is titrated with standard NaOH.



Before starting the AgNO_3 is made just alkaline to mixed indicator by adding 2 or 3 drops of N/200 NaOH and the titration is complete when the green colour returns to the solution.

If a running end point is obtained the cotton wool filter needs to be changed and the tube cleaned. When changing cotton wool always use dried material since the presence of moisture would cause the SO_3 to form H_2SO_4 and this would vitiate results.

Silver Nitrate

Dissolve 3.4 gms AgNO_3 in 400 ccs H_2O . Add 14 ccs mixed indicator solution and make up to one litre.

Do NOT use more than 14 ccs mixed indicator.

Mixed Indicator (Methyl Red and Xylene Cyanol)

Dissolve 0.1 gm methyl red in 100 ccs alcohol.

Dissolve 0.1 gm xylene cyanol in 100 ccs H_2O .

Use 7 ccs of methyl red and 7 ccs xylene cyanol for one litre of AgNO_3 .

N/20 NaOH or KOH

Dissolve 2 gms NaOH or 3.07 gms KOH in 100 ccs H_2O . Add 0.1 gm $\text{Ba}(\text{OH})_2$. Stopper flask and allow to stand at least 24 hours. Filter and make up to one litre. This is the stock solution.

N/200 NaOH or KOH

Take 100 ccs N/20 stock solution and dilute to one litre. Standardize with a steel of known sulphur content.

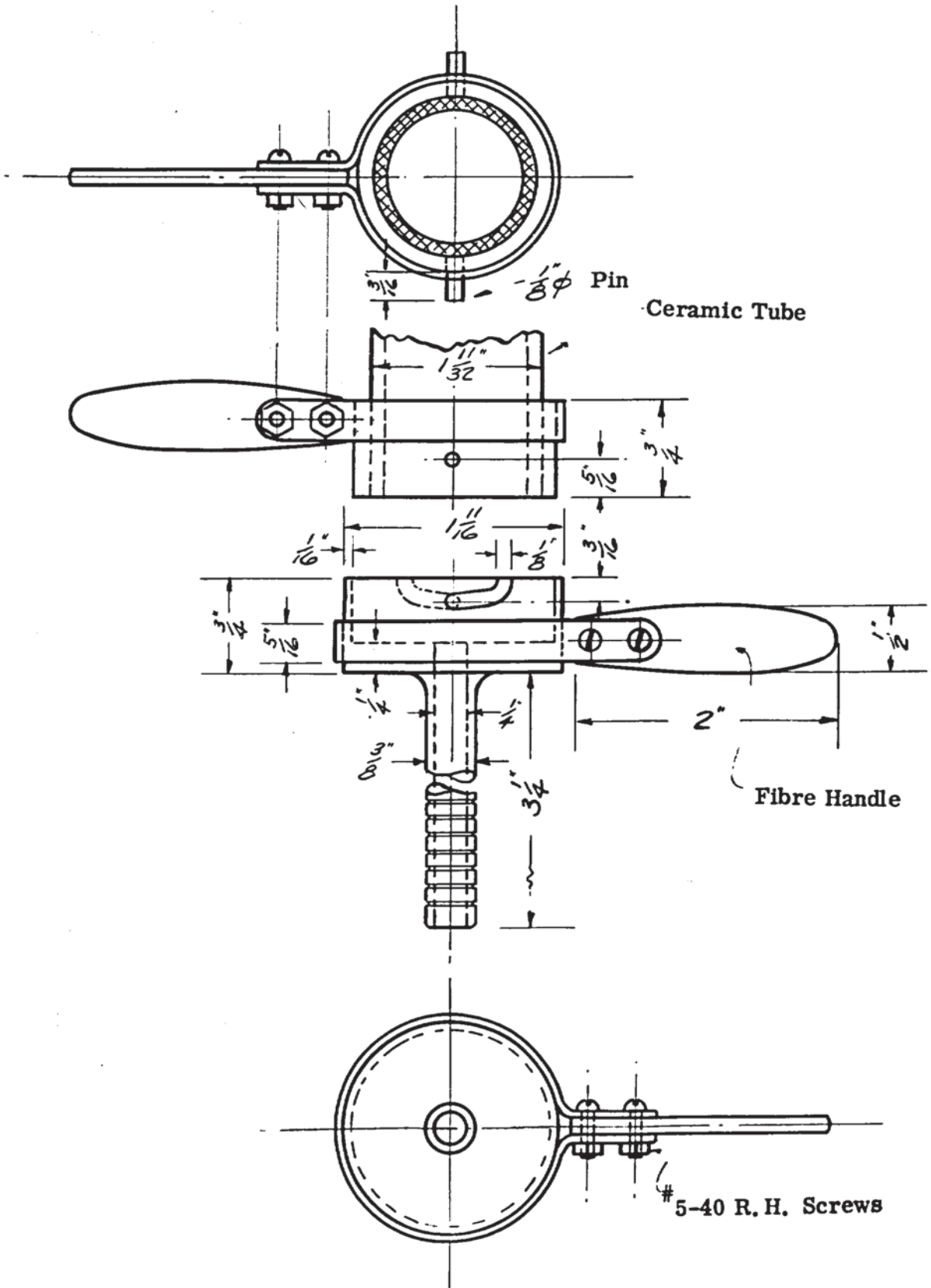

Figure 7 - Brass Adaptor for Sulphur Furnace

DETERMINATION OF PHOSPHORUS

Plain Steels

Weigh 2 gms sample into a 300 cc flask and add 10 ccs water.
Add 50 ccs HNO_3 (1200 HNO_3 : 1000 H_2O).
Heat until dissolved and add a drop at a time saturated KMnO_4 until a permanent precipitate forms.
Boil and add a few drops of saturated sodium sulphite to clear the solution and boil 1/2 minute.
Add 10 ccs NH_4OH (just neutral). Heat to 80°C .
Add 60 ccs of ammonium molybdate solution.
Shake and allow to stand at least one hour.
Filter and wash with 2% HNO_3 and finally with 1% KNO_3 .
When drip from filter is neutral to litmus, transfer filter and precipitate to original flask.
Dissolve in standard alkali and titrate with standard acid.

Standard Alkali

Weigh 100 gms NaOH into a 150 cc test tube.
Add 100 ccs H_2O and allow to stand 24 hours.
Transfer 17.5 ccs of this solution to a 2-litre flask and make up to the mark with water.

Standard Acid

Transfer 20 ccs HNO_3 to a 2-litre flask and make up to the mark with water.
Standardize by balancing acid against alkali and then run standard steel.

Ammonium Molybdate

- (1) ----- 960 ccs H_2O
 460 ccs HNO_3

- (2) ----- 100 gms molybdic acid
 240 ccs water
 140 ccs ammonia

Get all the molybdic acid in (2) into solution and add gradually to (1) with vigorous shaking between additions.

Alloy Steels

Weigh 2 gms sample into a 400 cc beaker.

Add 15 ccs HNO_3 and 25 ccs HCl . Heat gently until all is dissolved. Rinse sides of beaker and add 20 ccs HClO_4 . Evaporate to fumes and reflux with cover on for at least 10 minutes. Cool slightly. Re-dissolve by warming with 10 ccs HCl . Dilute with 20 ccs water and add 10 ccs HBr . Take to fumes with beaker uncovered. Cool slightly and add 35 ccs H_2O . Warm to obtain solution of the soluble salts and filter immediately on a 41H Whatman paper. Wash with dilute HNO_3 (2:98).

If steel contains W, Ti, Cb, Zr or Sn, examine residue for P.

Keep bulk below 80 ccs. Add 5 gms NH_4Cl or NH_4NO_3 . Warm to 75°C and add 35 ccs molybdate reagent.

Shake well and allow to stand 30 minutes.

Filter and complete as in plain steel method.

Solutions same as for plain steels.

Colour Photoelectric

Weigh 0.10 gm of sample into a 250 cc beaker.

Add 10 ccs HNO_3 (1.2) and cover with watch glass. Heat until in solution.*

Add 3 ccs HClO_4 (from a burette). Keep cover glass on and evaporate to fumes. Fume gently for 3 or 4 minutes.

Cool and add 20 ccs sodium sulphite (10%). Boil for one minute and add 10 ccs sodium sulphite (10%). Boil for one minute and add 50 ccs of freshly prepared ammonium molybdate hydrazine sulphate solution. Heat on steam bath for 20 minutes.

Cool in running water. Transfer to 100 cc volumetric flask and make up to mark with water. Compare in any suitable colorimeter Spekker Setting colour filter 608. W/W. 1.2 and 1 cm cells.

* Use any suitable solvent and add 3 ccs HClO_4 , etc. Eliminate Cr by adding NaCl .

Solution Required

HNO_3 (1.2)

380 ccs HNO_3 (conc)

620 ccs H_2O

Hydrazine Sulphate 0.15%

Ammonium Molybdate

Add 300 ccs H_2SO_4 to 500 ccs H_2O and cool. Dissolve 20 gms ammonium molybdate in solution and dilute to one litre with H_2O .

Ammonium Molybdate - Hydrazine Sulphate Reagent

Dilute 125 ccs of above ammonium molybdate to 400 ccs with H_2O . Add 50 ccs hydrazine sulphate and make up to 500 ccs with H_2O . This solution is not stable and should be prepared as needed.

To Standardize

Weigh 0.1 gm FeSO_4 into a 250 cc beaker. Add 10 ccs HNO_3 (1:1). Cover with watch glass. Heat and add 1.0, 2.0, 3.0, etc., ccs of standard ammonium phosphate. Add 3 ccs HClO_4 (from a burette). Keep cover glass on and evaporate to fumes. Fume gently for 3 or 4 minutes. Cool and finish as sample.

Standard Ammonium Phosphate

Weigh 0.2129 gm $(\text{NH}_4)_2\text{HPO}_4$ into a 150 cc beaker. Dissolve in 50 ccs H_2O . Transfer to a 100 cc volumetric flask. Transfer 10 ccs of this solution to a one litre volumetric flask and make up to the mark with H_2O .

$$1 \text{ cc} = 0.000005 \text{ gm P}$$
$$= 0.005\% \text{ on } 0.1 \text{ gm sample.}$$

DETERMINATION OF NICKEL

Dimethylglyoxime

Weigh 0.1 to 2 gms sample into a 400 cc beaker. Add 25 ccs 1:3 H_2SO_4 and boil. Add 5 ccs HNO_3 and boil off brown fumes. Add 25 ccs H_2O and 60 ccs citric acid solution. Make alkaline with NH_4OH . Add 5 gms NH_4Cl and filter. Wash with hot water. Acidify filtrate with HCl and heat to 80°C . Add 35 ccs dimethylglyoxime. Make just alkaline with NH_4OH and 2 ccs excess. Allow to stand 30 minutes and filter through a weighed Gooch crucible. Wash well with hot water. Dry for 2 hours in drying oven, temperature 105°C . Cool and weigh.

$$\text{Nickel dimethylglyoxime} \times 0.2032 = \text{Ni}$$

Citric Acid Solution

480 gms citric acid
80 ccs H_2SO_4
2000 ccs H_2O

Dimethylglyoxime

1% solution
1 gm in 100 ccs alcohol

Colour Photoelectric

Weigh 1/2 gm sample into a 250 cc beaker.
Add 20 ccs "Nickel Acid" and boil.
Add 5 ccs HNO_3 . Heat until clear.
Transfer to a 200 cc flask. Make up to mark.
Take two 10 cc portions A. and B. in 100 cc volumetric flask.

To A. (Blank) add:

10 ccs ammonium citrate
35 ccs of H_2O
1 cc of iodine
20 ccs NH_4OH (1:1)
Make up to mark.

To B. (Colour) add:

10 ccs ammonium citrate
35 ccs of H_2O
1 cc of iodine
20 ccs of 1:1 ammonium dimethyl-
glyoxime
Make up to mark.

Compare using any suitable comparator. Coleman setting 530 m μ .

"Nickel Acid"

300 ccs of H_2SO_4
300 ccs of H_3PO_4
Make up to 2 litres.

Nitric Acid Concentrated

Ammonium Citrate

500 ccs NH_4OH
500 gms citric acid
Make up to one litre.

Iodine N/10

12.69 gms iodine
25 gms KI
Make up to one litre.

Ammonium Hydroxide

500 ccs NH_4OH
500 ccs H_2O

Ammonium Dimethylglyoxime

1 gm dimethylglyoxime
500 ccs NH_4OH
500 ccs H_2O

To Standardize

Take two 100 cc volumetric flasks. A. and B.

To A. (Blank) add:

10 ccs of standard Ni
1 cc of nickel acid
10 ccs of ammonium citrate
35 ccs of H_2O
1 cc of iodine
20 ccs of NH_4OH (1:1)
Make up to mark.

To B. (Colour) add:

A* ccs of standard Ni
1 cc of nickel acid
10 ccs of ammonium citrate
35 ccs of H_2O
1 cc of iodine
20 ccs of 1:1 ammonium dimethyl-
glyoxime
Make up to mark.

*A ccs varies from 1 to 40 ccs depending upon the number of points required.

Standard Nickel Solution

3.3651 gms nickel ammonium sulphate a litre.

Take 200 ccs of this solution and dilute to one litre with H_2O .

Cyanide Method

Weigh 1/2 to 1 gm sample into a 400 cc beaker.
Add 20 ccs HCl (put in solution if possible)*.
Add 5 ccs HNO_3 . boil free of brown fumes.
Cool and dilute with 50 ccs H_2O .
Add 5 ccs AgNO_3 . (educt 0.2 ccs blank for each 5 ccs AgNO_3 added.)
Add enough sodium citrate to change colour of solution to a green**.
Make ammoniacal (just the faintest smell of NH_4OH).
Cool and dilute to 250 ccs with water.
Add 5 ccs KI and titrate with standard KCN.

*If steel will not dissolve in HCl try aqua regia or dilute H_2SO_4 or a combination of these with HF. Add enough perchloric and take to

fumes and almost to dryness. Take up with 20 ccs HCl and continue as above.

**Most texts say to add 50 to 75 ccs of sodium citrate but this is seldom enough.

<u>Sodium Citrate</u>	Saturated solution
<u>AgNO₃</u>	1.0 gm AgNO ₃ /litre
<u>Potassium Iodide</u>	80 gms / 2 litres
<u>Potassium Cyanide</u>	46 gms KCN 10 gms KOH

Dissolve the KOH in sufficient water. Add the KCN and make up to 2 litres.

Alternative for Sodium Citrate

1300 gms citric acid
1250 gms sodium carbonate

Dissolve citric acid in sufficient water and add the sodium carbonate carefully. Dilute to 5 litres.

To Standardize the KCN

Weigh two 1 gm portions of nickel ammonium sulphate into 400 cc beakers. Dissolve in about 50 ccs water add 5 ccs H₂SO₄. Then add 6 ccs AgNO₃ and continue as above.

1 gm NiAmSO₄ = 0.1485 gm Ni

DETERMINATION OF CHROMIUM STEELS

Weigh 2 gms sample into a 600 cc beaker.
Add 60 ccs "Chromium Acid" heat until in solution*.
Add 5 ccs HNO₃. Boil off brown fumes.
Dilute to 300 ccs with water. Add 10 ccs AgNO₃.
Add 10 ccs saturated ammonium persulphate. Boil 20 minutes.
Add 5 ccs 1:1 HCl and boil 10 minutes.
Cool quickly in cooler and titrate with ferrous ammonium sulphate until excess present.
Add 2 or 3 drops of O-P indicator and titrate with standard KMnO₄**.

*If steel will not dissolve in Cr acid, weigh out a fresh portion of sample and add 10 ccs HNO₃ and 20 to 50 ccs perchloric acid

depending upon whether 0.2 gm or 2.0 gm samples used. Boil and add a drop at a time 10 ccs HF.

**For Cr in Cr-V steels titrate to usual green end point and then continue until a permanent brown colour obtains.

Chromium Acid

1500 ccs H₂O
320 ccs H₂SO₄
100 ccs H₃PO₄

Add H₂SO₄ to water with constant swirling of the flask. Cool and add the H₃PO₄.

Silver Nitrate

25 gms AgNO₃/ 2 litres H₂O

Ferrous Ammonium Sulphate

140 gms FeAmSO₄
100 ccs H₂SO₄

Dissolve the FeAmSO₄ in sufficient water. Add the H₂SO₄, cool and make up to 2 litres with water.

Potassium Permanganate

3.16 gms KMnO₄

O-P Indicator

Dissolve 0.695 gm of ferrous sulphate (FeSO₄·7H₂O) in 100 ccs H₂O. Add 1.485 gms of ortho phenanthroline monohydrate. Stir until the latter is dissolved giving a dark red solution.

To Standardize KMnO₄

Weigh 0.24 gm of U.S. Bureau of Standards sodium oxalate (40c) into a 400 cc beaker. Add 200 ccs H₂SO₄(5%). When all is dissolved, titrate immediately with KMnO₄.

0.24 gm sodium oxalate = 0.2 gm Fe.

$$\frac{0.2}{\text{No. ccs KMnO}_4 \text{ used}} = \text{Fe value of KMnO}_4$$

Fe value of KMnO₄ x 0.3105 = Cr value.

DETERMINATION OF MOLYBDENUM
IN STEEL

Visual Colour

Weigh 0.2 gm sample into a 250 cc beaker.
Add 30 ccs perchloric acid and take to fumes.
Cool and add 50 ccs H₂O. Cool and transfer to a separatory funnel.
Add 10 ccs NaCNS (DO NOT USE KCNS). Add 25 ccs stannous chloride.
Add 15 ccs (exactly) butyl acetate. Shake funnel between additions and then settle. Pour off colourless portion and transfer coloured portion to a suitable comparator.

NaCNS 5% Solution

Stannous Chloride

112 gms SnCl₂
110 ccs HCl

Dissolve the SnCl₂ in the HCl and dilute to one litre with water.

To Prepare Standards

Weigh out sufficient standard steel to make one litre of solution so that one cc = 0.00002 gm Mo or one cc = 0.01% on 0.2 gm sample. (8.97 gms standard 72B or 4.4843 gms).

Photoelectric (0-0.6%)

Weigh two 0.1 gm portions into a 250 cc beaker.
Add 25 ccs perchloric acid. Take to fumes and cool.
Transfer to 100 ccs volumetric flasks (volume about 50 ccs).
To number 1 add 10 ccs NaCNS
25 ccs SnCl₂ and dilute to mark.
To number 2 add 25 ccs SnCl₂ and dilute to mark.
Allow to stand 15 minutes and compare.
Coleman Setting 470 m μ . Spekker Setting W/W 1.0 Ilford Spectrum Filter 602 Blue.

NaCNS 10% solution
SnCl₂ Same as in visual method

Photoelectric (0.6%-3.0%)

Weigh 0.2 gm sample into a 250 cc beaker, add 25 ccs perchloric acid, take to fumes, cool.

Transfer to a 200 cc flask, make up to mark with H₂O.
Take two 20 cc aliquots in 250 cc beakers, add 0.3 gm ferrous sulphate (FeSO₄·7H₂O), and 20 ccs perchloric acid. Take to fumes.
Cool and transfer to 100 cc volumetric flasks and continue as above.

A-Benzoinoxime Method

Weigh 1 to 10 gms sample into a 600 cc beaker.
Add 50 to 100 ccs (1:3) H₂SO₄. Heat until action ceases.
Add just enough HNO₃ to decompose carbides.
Add a few drops of HF and boil.
Add 10 ccs boric acid solution. Boil and if solution is not clear, filter.
Dilute to 100 ccs with water. Cool to 25°C.
Add one spoonful (about 0.5 to 1 gm) of ferrous sulphate to reduce vanadic and chromic acid.
Cool to 5°C (in frigidaire).
Add slowly and with stirring 35 ccs A-benzoinoxime (10 ccs plus 5 for each 0.01 gm Mo present).
Stir and add just enough bromine water to change the colour of the solution.
Allow beaker and contents to remain in cooler for 10 minutes stirring occasionally. Add 2 spoonful of paper pulp and filter through a 30 Whatman.
If first 50 ccs or so are not clear, filter again.
Wash the paper and precipitate until colourless with A-B wash.
Transfer paper and precipitate to a vitreosil crucible, ignite cautiously, char without flame and finish ignition at 500 to 525°C.
When ignited fuse with bisulphate leach in 600 cc beaker.
Precipitate the Fe with NH₄OH. Filter and re-precipitate Fe.
Evaporate filtrates to volume of 200 ccs, neutralize with (1:3) H₂SO₄ and add 20 ccs in excess.
Pass through Jones Reductor and collect in a receiver containing 25 ccs ferric ammonium sulphate and 25 ccs Fe titrating solution.
Titrate with standard KMnO₄.

$$\text{Fe Value of KMnO}_4 \times 0.5733 = \text{Mo}$$

A-Benzoinoxime

Dissolve 10 gms A-B in 500 ccs ethyl alcohol. Keep in frigidaire.

Boric Acid

Dissolve 4 gms boric acid in 100 ccs H₂O.

A-B Wash

35 ccs A-B above
100 ccs H_2SO_4
1 litre H_2O

Use cold and fresh. Keep in frigidaire.

Fe Titrating Solution

Dissolve 70 gms of $MnSO_4 \cdot 4H_2O$ in 500 ccs water.
Add with stirring 125 ccs H_2SO_4 and 125 ccs H_3PO_4 and dilute to approximately one litre.

Ferric Ammonium Sulphate

200 gms ferric ammonium sulphate
40 ccs H_2SO_4
1760 ccs H_2O

DETERMINATION OF VANADIUM
IN STEEL

Potentiometric

Weigh 1 to 2 gms of sample into a 400 cc beaker.
Add 100 ccs (1:4) H_2SO_4 . Boil and add 5 ccs HNO_3 .
(If W present add 8 ccs). Boil off brown fumes and dilute to 200 ccs with water.
Add 40 ccs HNO_3 and boil for 35 to 40 minutes letting solution evaporate to 100 to 125 ccs.
Cool and dilute with 300 ccs cold water. Titrate with standard ferrous ammonium sulphate using the "Electric Eye".

Ferrous Ammonium Sulphate

Dissolve 9.804 gms in sufficient water. Add 20 ccs H_2SO_4 and make up to exactly one litre with water.

1 cc = 0.001275 gm V

Sodium Azide

Weigh 5 gms sample into a 600 cc beaker.
Add 50 ccs (1:3) H_2SO_4 . Heat until in solution.
Add 5 ccs HNO_3 and 30 ccs H_3PO_4 and boil.
Dilute to 300 ccs with water.

Add 1 cc FeAmSO_4 (used for Cr) Cool to room temperature.
Add KMnO_4 until a pink colour persists for 2 minutes.
Add 5 ccs sodium azide. Boil to destroy excess.
Add 0.6 cc diphenyl benzidine indicator*.
Titrate with 0.025M FeAmSO_4 .
Add 0.2 cc for blank.

*If Cr is high add enough indicator to get the blue colour and
ADD a blank of 0.2 cc for every 0.6 cc of indicator used.

Sodium Azide 3.25 gms/500 ccs.

Diphenyl Benzidine Indicator

Dissolve 0.1 gm diphenyl benzidine in 10 ccs H_2SO_4 .
Add 90 ccs glacial acetic acid.

Ferrous Ammonium Sulphate

9.804 gms/litre

DETERMINATION OF TUNGSTEN
IN STEEL

Weigh 1/2 to 2 gms sample into a 250 cc beaker.
Add 50 ccs HCl and 15 ccs HNO_3 . Cover all with a watchglass and
boil down to about 5 ccs.
Add 10 ccs HCl and boil down to about 5 ccs with cover on.
Take up with 35 ccs water, boil and filter through a No. 32
Whatman paper.
Wash well with hot 10% HCl and finally with hot water. (Reserve
filtrate. Note 1).
Place original beaker under funnel and dissolve tungsten by
pouring sufficient NH_4OH into filter.
Wash with 10% NH_4OH (Note 2). Acidify filtrate with HCl and add
10 ccs in excess.
Add 5 ccs HNO_3 . Boil down to about 5 ccs with cover on.
Add 10 ccs HCl and repeat.
Then take up with 35 ccs H_2O . Boil and filter through a No. 32
Whatman paper.
Wash well with 10% HCl and finally with water. Place a weighed
platinum dish under funnel and pour enough NH_4OH to dissolve
tungsten into filter. Wash with 10% NH_4OH . Evaporate solution in
dish to dryness. Ignite at dull red heat (less than 500°C), cool
and weigh.

$$\text{WO}_3 \times 0.79303 = \text{W}$$

Note 1

Place cover on filtrate and boil down to about 5 ccs, add 10 ccs HCl and repeat. If any tungsten, add to precipitate in final operation.

Note 2

If there should be any iron on filter place a clean 250 cc beaker under funnel and dissolve the iron with sufficient 1:1 HCl. Add 5 ccs HNO₃ and cover beaker with watchglass. Boil down to 5 ccs. If any tungsten, take up with 35 ccs water, filter and add tungsten to main section.

DETERMINATION OF TITANIUM
IN STEEL

Cupferron Method

Weigh 1/2 to 3 gms sample into a 250 cc beaker. Add 50 ccs (1:9) H₂SO₄. Heat until action ceases. Dilute to 100 ccs with water. Cool to 5°C. Add some paper pulp. Add dropwise a cold freshly prepared 6% solution of cupferron (Cool it in frigidaire) with constant stirring until the precipitate assumes a reddish-brown colour. Filter immediately through a No. 41 Whatman paper containing some paper pulp. Wash 10 to 15 times with cold (frigidaire) 5% H₂SO₄. If steel contains small amounts of W or Mo wash 5 times or more with cold (frigidaire) 5% NH₄OH. Transfer precipitate and paper to a platinum crucible and ignite (without flame) at a low temperature. Fuse with pyrosulphate and leach with water. Add 1 cc H₃PO₄ and 25 ccs (1:9) H₂SO₄ and prepare a similar blank. Transfer to matched Nessler tubes. To each add 3 ccs of 3% H₂O₂ and match colour with standard titanium sulphate.

Cupferron

Make sufficient fresh 6% solution.

Titanium Sulphate

Fuse 0.834 gm TiO₂ with Na₂CO₃. Dissolve in a large excess of H₂SO₄. Evaporate if necessary. Dilute to one litre. Solution should be freely acid and one cc = 0.0005 gm Ti. To standardize this solution, transfer 100 ccs to a titanium bulb containing liquid Zn-Hg amalgam. Reduce and titrate with standard ferric ammonium sulphate.

DETERMINATION OF COPPER
IN STEEL

Weigh 5 gms sample into a 600 cc beaker.
Add 100 ccs (1:9) H_2SO_4 and heat to boiling.
Dilute to 250 ccs with H_2O and boil.
Add 10 ccs of 50% solution sodium thiosulphate.
Boil 10 minutes. Filter and wash with (1:9) H_2SO_4 saturated with H_2S . Ignite slowly at low temperature.
Transfer to a 250 cc beaker.
Add 10 ccs bromine water and 10 ccs HNO_3 .

- (1) Boil off the brown fumes and dilute to 100 ccs.
Precipitate Fe with NH_4OH and re-precipitate.
Boil off excess NH_4OH and add acetic acid until neutral and add 5 ccs in excess. Boil and cool. Add 3 gms KI and titrate with standard hypo to usual end point.
- (2) Boil to dissolve Cu, add 8 ccs H_2SO_4 and take to fumes of sulphuric. Rinse down sides of beaker and refume leaving 4 ccs H_2SO_4 . Cool and take up with 50 ccs water. Heat until all salts are in solution and transfer to an electrolytic beaker, and electrolyze.

Standard Sodium Thiosulphate

19.5 gms/litre

To Standardize

Place 100 ccs H_2O in a 300 cc conical flask. Add 5 ccs glacial acetic acid.
Add 25 ccs standard $KMnO_4$.
Add 2 spoonful (about 5 gms) KI.
Titrate with thiosulphate to usual end point.

Fe Value of $KMnO_4$ x 1.23686 x No. of ccs $KMnO_4$ taken

No. of ccs of hypo required

= Pb value of thiosulphate

Pb value x 0.9204 = Cu value.

Photoelectric (0-0.5%)

Weigh 1/2 to 1 gm sample into a 250 cc beaker.
Add 10 ccs HCl. Boil and add a few drops of HNO₃ to dissolve carbides.
Transfer to 100 cc volumetric flask. Make up to mark with H₂O.
Transfer a 5 cc aliquot to a 100 cc beaker.
Add 5 ccs hydroxylamine hydrochloride (10%).
Add 5 ccs tartaric acid (10%).
Adjust pH from 6.0 to 7.5 with NH₄OH (1:1).
Transfer to 60 cc separatory funnel.
Add exactly 10 ccs cuproine (0.02%).
Shake for 1/2 minute.
Draw off organic layer into a photometric cell and compare in suitable comparator. Beckman B setting 545 mμ.

Cuproine

Dissolve 100 mgs cuproine in 500 ccs n-amyl alcohol. Stir thoroughly and allow to stand until dissolved.

DETERMINATION OF COLUMBIUM
IN STEEL

Weigh 2 gms sample into a 250 cc beaker.
Add 20 ccs HCl and heat gently.
Add 10 ccs HNO₃. Boil until all sample is dissolved.
Add 30 ccs perchloric acid and take to fumes.
Cool rapidly. When cool, dilute with about 100 ccs water and filter through a No. 41H Whatman paper into a 600 cc beaker. Wash thoroughly with water, then twice with 1:1 HCl, and finally with water.
Reserve filtrate.
Ignite paper and precipitate in a platinum crucible.
Weigh, then HF and re-weigh. This gives Si.

$$\text{Loss in weight} \times 0.2336 \times 100 = \% \text{ Si}$$

Dilute filtrate to 400 ccs and boil to precipitate Cb by hydrolysis and filter through a No. 32 Whatman paper.
Ignite in crucible containing residue from HF treatment.
Fuse with bisulphate.
Leach with 15 ccs (1:1) HCl and dilute to 300 ccs with water. Boil for 20 minutes. Settle for half an hour and filter through a No. 42 Whatman paper. Wash thoroughly with 2% HCl. Ignite slowly and finally at 1000 to 1050°C for at least 15 minutes.

$$\text{Cb}_2\text{O}_5 \times 0.3495 \times 100 = \text{Cb}\%$$

$$\text{Cb}_2\text{O}_5 \times 0.6990 = \text{Cb}$$

DETERMINATION OF ALUMINIUM
IN CAST IRON AND STEEL

Weigh 5 to 10 gms sample into a 600 cc beaker.

Add 60 to 110 ccs H_2SO_4 (1:9).

Dilute to 250 ccs with boiling water and add 10 ccs of saturated sulphurous acid.

Add slowly from a burette with constant shaking sodium bicarbonate (8% solution) until a permanent precipitate is formed. (About 50 ccs required for 1 gm sample).

Add 8 ccs in excess. Boil for one minute and filter immediately through a 12 cm No. 30 Whatman paper.

Wash 2 or 3 times with hot water.

Discard filtrate and dissolve precipitate through the paper into original flask with 50 ccs hot dilute H_2SO_4 (1:9).

Wash the filter paper completely with hot water and reserve filtrate.

Ignite the paper in a platinum crucible at $850^\circ C$ and after treating residue with H_2SO_4 and HF, fuse with 2 to 3 gms potassium bisulphate.

Extract cooled melt in the reserved filtrate and dilute to 150 ccs.

Heat to boiling. Add 2 to 3 gms ammonium persulphate in 0.5 gm portions, boiling between each addition.

Boil for several minutes to destroy the excess persulphate. Should a precipitate or colour due to manganese form, clear the boiling solution by addition of a few drops of 1:1 HCl.

Cool the solution slightly and add 10 ccs of tartaric acid solution (50%).

Add NH_4OH to an excess of 1 cc. Add 15 gms of KCN. Heat to boiling. Add 10 ccs ammonium sulphide solution (10%) and digest for 15 minutes. Cool to room temperature and filter through a paper pad, washing with 10% ammonium chloride solution. To the filtrate add slowly 10 to 20 ccs of 10% 8-hydroxyquinoline alcoholic solution stirring vigorously. Heat to $60^\circ C$. Allow to stand 15 minutes and filter through a paper pad, washing with warm water at $50^\circ C$.

Dissolve the precipitate into original beaker with 20 ccs hot HCl (100:16) washing with hot dilute HCl (5:95).

Add 5 ccs H_2SO_4 and take to fumes. Destroy organic matter with small addition HNO_3 until the solution is clear.

Take up with 100 ccs H_2O , add 5 ccs tartaric acid and neutralize with NH_4OH . Warm from 50 to $60^\circ C$. Add a sufficient excess of 3% acetic acid solution of 8-hydroxyquinoline. (Dissolve 3 gms of solid in minimum amount of glacial acetic acid. Dilute to 100 ccs with H_2O and add NH_4OH dropwise until a turbidity forms. Clear solution by adding dilute acetic acid).

Add 40 gms of ammonium acetate in sufficient water to dissolve it. Stir well and allow to cool to room temperature. Filter through a weighed medium glass frit crucible and wash with hot water. Dry at $110^\circ C$.

Weight of precipitate $\times 0.0587 = Al$.

Instead of weighing precipitate, finish volumetrically as follows:

Dissolve precipitate in sufficient HCl.

Dilute to 150 ccs with water.

Add a few drops of methyl red indicator and a measured excess of bromate bromide solution.

Add KI and titrate with standard hypo.

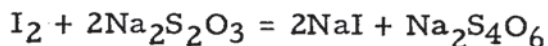
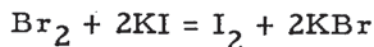
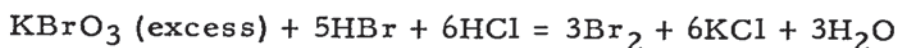
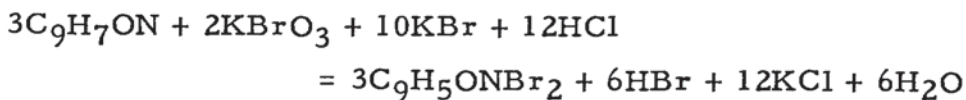
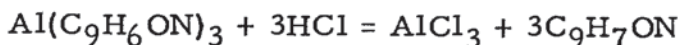
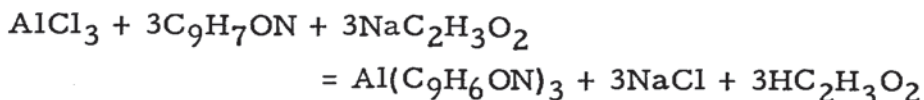

Bromate Bromide Solution

2.784 gms KBrO_3 and 12 gms KBr /litre

DETERMINATION OF CERIUM IN CAST IRON AND STEEL

Weigh one gm sample into a 250 cc beaker.

Add 30 ccs HCl (1:1). Heat until in solution.

Filter through a No. 32 Whatman paper into a 200 cc volumetric flask. Wash well with HCl (1:19) and make up to volume with water.

Transfer a 20 cc aliquot to a 150 cc beaker. Add 2 ccs citric acid*.

Add NH_4OH * dropwise until just barely ammoniacal (until the first drop changes colour from deep yellow to light green). Then add 5 or 6 drops in excess. Add 4 ccs KCN* solution and heat to boiling.

Add 15 drops of sodium hydrosulphite. Add 3 to 4 drops H_2SO_4 (1:4). Boil until Fe reduced (15 ccs).

Wash down sides of beaker with hot water.

Cool and add phenolphthalein indicator.

Add NH_4OH * carefully until just alkaline.

Add exactly 5 ccs NH_4OH * in excess (pH 10.2).

Transfer to a separatory funnel. Adjust volume to 50 ccs with water.

Add 11 ccs 8-hydroxyquinoline. Shake for 3 minutes.

After solution settles, draw off chloroform layer into a small stoppered bottle containing one gm anhydrous sodium sulphate. Allow to stand at least one hour and compare in a suitable comparator** (510 m μ for Coleman).

* These solutions must be added exactly from burette.

**If V present compare after 5 minutes standing.

Notes

- (1) Cerium free steel N. B. S. 55C used as blank.
- (2) 0.3% V and 1.2% Mn can be tolerated.
- (3) For Ni-Cr alloy a preliminary Hg-cathode separation is necessary.
- (4) Cerium alone is extracted by this method.

Citric Acid 500 gms/litre

Potassium Cyanide 400 gms KCN and 15 gms NaOH/litre

Sodium Hydrosulphite

2.5 gms in 25 ccs H₂O containing a few drops NH₄OH. Must be freshly prepared.

Phenolphthalein

Dissolve 0.5 gm in alcohol made up to 50 ccs with H₂O.

8-Hydroxyquinoline

Dissolve 6 gms pure 8-hydroxyquinoline in 200 ccs anhydrous, acid-free chloroform to which has been added 20 ccs acetone.

Must be freshly prepared.

To Construct Standard Curve

A cerium salt is dissolved in water so that one ml = 0.2 mgms of cerium. Aliquots of this solution are added to 1 gm of cerium free standard steel (N. B. S. 55C) and processed as in method.

DETERMINATION OF TIN

Low Chromium Steels

Weigh 2 gms of sample into a 400 cc beaker.
Add 20 ccs HCl and digest until dissolved.
For samples with less than 0.05% Sn use 5 gms and 35 ccs HCl.
Dilute with 40 ccs H₂O and filter through No. 41H Whatman paper into a 500 cc flat bottom flask. Wash once with warm 1:1 HCl and complete washing with hot water (Note 1).
To the filtrate add 50 ccs HCl and 5 ccs of antimony chloride solution and dilute to 200 ccs with water.
Heat to boiling and carefully add enough aluminium metal to reduce the Fe (about 1 to 2 gms). When this has dissolved, place rubber stopper with a tube extending to a beaker containing a saturated solution of sodium bicarbonate and boil for 30 minutes. Remove from hot plate and cool under running water with tube still in the bicarbonate solution. When cold remove stopper. Add 10 ccs KI (10%) and 5 ccs of starch (1%) and titrate immediately with N/100 iodine.

$$\text{Sn}\% = \frac{\text{ccs of N/100 iodine used}}{\text{Wt. of sample taken}} \times 0.05935$$

Note 1

With cast irons examine residue for tin.
Ignite paper below 550°C. Transfer to a nickel crucible and fuse with 5 gms sodium peroxide. Extract with water. Acidify with HCl and add to main filtrate.
Adjust volume to 200 ccs and proceed with reduction.

Note 2

Run a blank determination containing an equivalent weight of tin-free iron at the beginning of each series. (Blank about 0.2 ccs)

Solutions

antimony chloride	0.5% solution
potassium iodide	10% solution
	10 gms KI/100 ccs H ₂ O

N/100 Iodine

Dissolve 1.2692 gms of iodine in 10 gms KI dissolved in about 50 ccs H₂O and dilute to one litre with water. Standardize using a standard steel.

DETERMINATION OF TIN
IN STEEL

Polarographic

Weigh 2 gms sample into a 400 cc beaker. Add 25 ccs H₂O and 40 ccs HCl. When in solution dilute to 200 ccs. Add a spoonful of paper pulp. Warm and filter through a No. 30 Whatman paper into a 600 cc beaker. Wash well with H₂O and discard precipitated filter. Neutralize filtrate with NH₄OH (1:1). Dissolve precipitate with HCl (1:1) added dropwise, then 10 ccs in excess. Dilute to 400 ccs with H₂O. Add 2 ccs ammonium molybdate (1% aqueous solution). Pass H₂S for an hour. Settle for 2 hours. Filter with aid of paper pulp. Wash well with H₂S water (1% HCl). Return paper and precipitate to the original beaker. Add 25 ccs HNO₃ and 10 ccs H₂SO₄. Take to fumes. (Add more HNO₃ if necessary to destroy all organic matter). Cool and take up with 100 ccs H₂O. Boil. Add 5 ccs ammonium aluminium sulphate (8.5%). Make solution slightly alkaline with NH₄OH (1:1). Filter and wash well with hot water. Place a 100 cc volumetric flask under funnel and dissolve the hydroxides with 50 ccs hot HCl (4 normal). Wash paper twice with hot water. To the solution in the flask add 16 gms NH₄Cl and 3 ccs of gelatin (0.2%). Make up to mark with H₂O. Remove oxygen by bubbling nitrogen through solution and take polarogram.

Sn - 0.6 Volts. vs. S. C. E.

DETERMINATION OF TANTALUM
IN STAINLESS STEELS

Weigh 2 gms sample into a 250 cc beaker. Add 25 ccs HCl. Cover and boil until action ceases. Add 5 ccs HNO₃ in small portions. Evaporate down to 10 to 15 ccs and cautiously add 30 ccs HClO₄. Boil until HClO₄ refluxes on side of beaker and continue boiling for 15 minutes. (Do not allow to become pasty or dry). Cool. Add 5 ccs HCl and dilute with 35 ccs water. Swirl and filter immediately through a No. 41H Whatman paper. Wash paper several times with water and then with 1:1 HCl and finally with water. Reserve paper and precipitate. Dilute filtrate and washings to about 400 ccs. Heat to boiling and reduce with H₂SO₃. (Solution turns green). Boil for half an hour and let settle. Filter through a No. 42 Whatman paper and wash with 5% HCl. Transfer paper and

precipitate along with reserved paper to a platinum crucible and ignite. Cool and add 2 ccs H_2SO_4 and 5 ccs HF. (2 ccs H_2SO_4 necessary to prevent volatilization of Ta). Evaporate to dryness, heat to dull redness, cool and add 5 to 10 gms potassium bisulphate. Fuse and swirl melt against sides of crucible. Leach melt with hot saturated ammonium oxalate solution in a 400 cc beaker. Wash crucible with hot water and bring volume in beaker up to 125 ccs with hot saturated ammonium oxalate. If the solution is not perfectly clear add a few drops of H_2SO_4 (1:35). Heat to boiling. Stir and neutralize with NH_4OH (1:1) adding drop by drop to the appearance of a faint cloudiness. Remove cloudiness immediately with a drop or two of HCl (1:1). The solution should be red to litmus at this point. Dilute with an equal volume of saturated NH_4Cl solution and heat to boiling. Add fresh 5% tannin solution dropwise with stirring. Leave the beaker on the hot plate until the precipitate gathers into clouds, leaving the liquid clear. If liquid shows an orange tint, add more tannin solution. A colourless or pale straw yellow tint indicates precipitation is complete (Tantalum precipitate is yellow. Columbium is purplish-red). Digest on hot plate for half an hour and filter hot through a No. 41H Whatman paper. If any cloudiness in first few ccs, refilter and wash with hot ammonium chloride and ammonium oxalate (5%:1%) and ignite in a silica crucible.

DETERMINATION OF SELENIUM

Weigh 5 gms of sample into a 400 cc beaker and treat cautiously with 50 ccs of mixture of equal parts of HCl and HNO_3 regulating the violent reaction by cooling in running water. After decomposition, evaporate just to dryness on a water bath and redissolve by digesting with 50 ccs dilute HCl (1:3). Filter through a pad, washing two or three times with dilute HCl (1:9) and finally with water. Dilute the filtrate to about 150 ccs, add 100 ccs HCl and digest at 70°C for a few minutes. Cool to 20°C and pass a stream of SO_2 until the solution is saturated. Warm the solution to 70°C . Allow to cool one hour and filter on a closely packed paper pad, washing with warm dilute HCl (1:9) and finally with hot water until free from chlorides. Transfer the pad and residue to a 250 cc beaker, add a mixture of 15 ccs HNO_3 and 10 ccs H_2SO_4 and heat to destroy organic matter, making further additions of HNO_3 if required. Cool. Dilute to 50 ccs and warm to 70°C . Make faintly ammoniacal. Digest for 50 minutes and filter through a small paper pad, washing with hot water. (This removes any last traces of iron). Acidify the filtrate with dilute H_2SO_4 (1:1) to an excess of 20 ccs. Heat to 60°C . Add 3 gms of urea, stir, allow to stand, and cool to room temperature. Add 3 gms of KI, stir for 3 minutes and dilute to 300 ccs. Titrate carefully with N/20 sodium thiosulphate

until the iodine gradually fades and add approximately 5 ccs of N/20 sodium thiosulphate in excess. Add 5 ccs of starch solution (1%) and titrate with N/20 iodine to a permanent blue colour.

$$\text{Selenium \%} = \frac{A - B}{\text{Lot of sample taken}} \times 0.098\%$$

Where A = ccs of N/20 sodium thiosulphate

B = ccs of N/20 iodine

Solutions Required

	12.5 gms Na ₂ S ₂ O ₃)	
<u>N/20 Sodium Thiosulphate</u>)	dissolve
	0.1 gm Na ₂ CO ₃)	

in sufficient water and make up to one litre.

N/20 Iodine

Dissolve 6.35 gms iodine in 100 ccs KI solution (10%) and make up to one litre with water.

To Standardize Sodium Thiosulphate Run 20 ccs of N/10

KMnO₄ into 50 ccs dilute H₂SO₄ (5:95) containing one gm of KI. Shake and titrate the liberated iodine with Na₂S₂O₃.

DETERMINATION OF MAGNESIUM
IN CAST IRONS

Weigh 10 gms sample into a 600 cc beaker.
Add 100 ccs of 1:1 HCl. When in solution add 15 ccs HNO₃ to oxidize the iron and evaporate to dryness.
Add 50 ccs HCl and heat until the soluble salts are in solution.
Add 150 ccs H₂O, heat and filter through a coarse paper.
Evaporate filtrate to 60 ccs and transfer to a separatory funnel.
Cool and add 100 ccs ether. Shake well and allow to settle.
Draw off the acid layer.
Evaporate until all the ether is driven off.
Add 5 ccs HNO₃ and evaporate to 20 ccs.
Repeat ether extraction.
Draw off the acid layer.
Add 5 ccs H₂SO₄ (1:1) and evaporate to fumes.
Take up with 50 ccs H₂O. Boil into solution.
Neutralize with NH₄OH until the precipitate that forms just dissolves.

Transfer to Hg cathode cell and electrolyse until all of the iron and alloying elements are deposited.

Transfer solution to a beaker and heat to boiling.

Add 10 gms of NH_4Cl and make just alkaline with NH_4OH .

Add 5 gms of $(\text{NH}_4)_2\text{S}_2\text{O}_8$ and boil 5 minutes.

If the solution becomes acid add NH_4OH .

Filter and wash 1% NH_4Cl (just alkaline with NH_4OH).

If magnesium is high, dissolve precipitate with hot HCl and re-precipitate with NH_4OH and $(\text{NH}_4)_2\text{S}_2\text{O}_8$.

Combine the filtrates and acidity with HCl .

Heat to boiling. Boil off excess $(\text{NH}_4)_2\text{S}_2\text{O}_8$.

Add 10 ccs saturated ammonium oxalate.

Make just alkaline with NH_4OH using methyl red indicator.

Allow to stand for 30 minutes.

If any precipitate, filter and wash well with hot water.

Cool filtrate.

Add 25 ccs of 10% ammonium phosphate.

Neutralize with NH_4OH , stir vigorously, and add 10 ccs NH_4OH for every 100 ccs of solution.

Allow to stand overnight.

Filter and wash thoroughly with 5% NH_4OH .

Ignite gently without flame and finally at white heat.

Cool and weigh $\text{Mg}_2\text{P}_2\text{O}_7$.

$$\text{Mg}_2\text{P}_2\text{O}_7 \times 0.2184 = \text{Mg.}$$

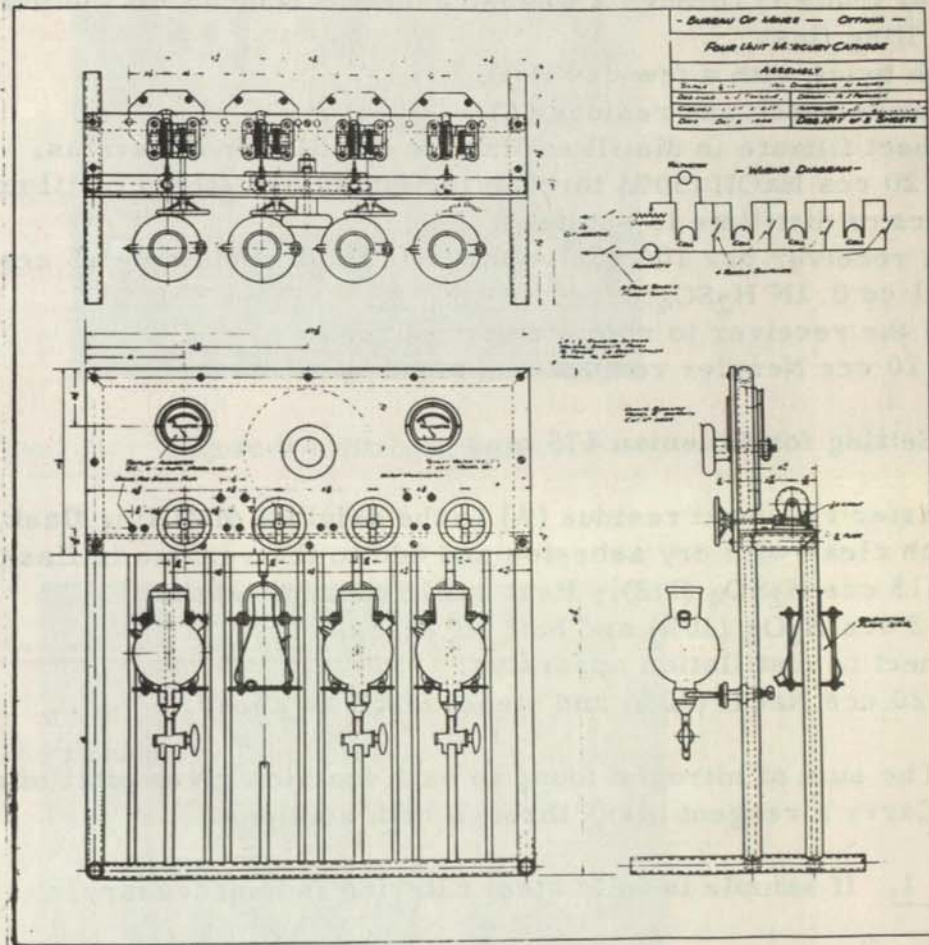

Figure 8 - HG Cathode-Plan

DETERMINATION OF NITROGEN
IN STEEL

Weigh 1 gm sample into a 250 cc distilling flask.
Add 20 ccs H_2SO_4 (1:3). Heat until reaction ceases.
Add 3 ccs H_2O_2 (30%) and boil off excess.
Filter (Note 1) through a washed asbestos Gooch into another 250 cc distilling flask.
Wash twice with a few ccs H_2O .
Reserve Gooch and residue (A).
Connect filtrate in distilling flask to distillation apparatus.
Add 20 ccs NaOH (50%) through the funnel and steam distil until 60 ccs of distillate is obtained.
As a receiver use 100 ccs volumetric flask containing 25 ccs H_2O and 1 cc 0.1N H_2SO_4 .
Cool the receiver to room temperature.
Add 10 ccs Nessler reagent and make up to mark.

Setting for Coleman 475 m μ .

Transfer reserved residue (A) to the original distilling flask, wipe Gooch clean with dry asbestos and add to the residue in flask.
Add 15 ccs H_2SO_4 (1:2). Heat until reaction ceases.
Add 3 ccs H_2O_2 (30%) and boil off excess.
Connect to distillation apparatus.
Add 20 ccs NaOH (50%) and steam distil as above.

The sum of nitrogen found in each fraction gives total nitrogen.
Carry a reagent blank through both sections.

Note 1. If sample is mild steel filtering is unnecessary.

N/10 H_2SO_4

3 ccs H_2SO_4 (conc.)/litre.

Nessler Reagent

30 gms potassium iodide
22.5 gms iodine
30 gms mercury
975 ccs NaOH (10%).

Dissolve the KI in 20 ccs H_2O in a 300 cc conical flask. Add the iodine. When all dissolved add the Hg, shaking well and keeping cool with running water. Continue shaking until the supernatant liquid has lost all yellow colour due to iodine. Decant the supernatant liquid and add a drop or two of 1 cc of starch. If starch shows no iodine add a few drops of an iodine solution of the same concentration as above until a faint trace of iodine is detected. Then dilute to 200 ccs with H_2O . Mix well and add to the 975 ccs NaOH (10%) accurately prepared. Mix and allow to clear by standing.

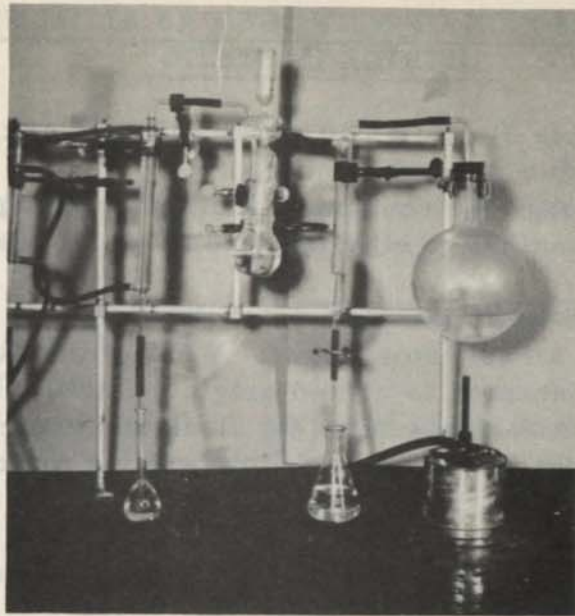

Figure 9 - Nitrogen Still



Figure 10 - Aluminum Nitride Still

DETERMINATION OF NITROGEN AS ALUMINUM
NITRIDE IN STEEL

Weigh 1 gm sample (Note 1) into a 250 cc distilling flask.
Set up for refluxing with a water condenser.
Add 3 ccs bromine through the condenser from a weighing burette.
Add 15 ccs anhydrous methyl or ethyl acetate in small portions through condenser (Note 2).
Heat and allow to reflux until sample is dissolved.
Cool and filter through an asbestos Gooch. Wash with anhydrous acetate.
Transfer residue and asbestos to rinsed original flask, wipe crucible with asbestos and add to residue. Dry the flask and contents at 105°C.
Connect flask to distillation apparatus and determine nitrogen as for Nitrogen in Steel.

Note 1. If nitrogen is low use 3 gms sample 9 ccs bromine and 45 ccs acetate.

Note 2. No reaction is noted until a few drops of acetate have been added. The acetate initiates a vigorous reaction.

DETERMINATION OF BORON
IN STEEL

Colorimetric

Weigh 1 gm sample into a marked test tube.
Add 8 ccs (1:4) H_2SO_4 . Stopper with an air condenser and place in a beaker of hot water. When action ceases cool with running water. Disconnect air condenser and wash with two 0.5 cc portions of water. Dilute to the 10 cc mark and mix thoroughly and filter into a dry test tube.
Reserve, as this filtrate contains the soluble boron. Replace test tube with a beaker and wash paper with water and then (1:20) H_2SO_4 and finally with water to remove all the acid. Discard washings. When paper is drained scatter 0.5 gm Na_2CO_3 on the inside of paper and place in a platinum crucible. Ignite at a low temperature and finally fuse 15 to 20 minutes. Cool and add 5 ccs H_2O and dropwise 1:1 H_2SO_4 until all dissolved and solution slightly acid. Avoid an excess of more than 4 to 5 drops. Transfer to a marked test tube and rinse crucible with two 1 cc portions of water.
Cool and dilute to 10 cc mark and mix well.
This solution contains the insoluble boron.
Pipette 2 ccs aliquot from each of the above into dry test tubes.
Slowly add 20 ccs 98.5% H_2SO_4 to each, stopper, cool, and add one cc quinalizarin solution. Stopper and mix by swirling gently.
Settle and compare.

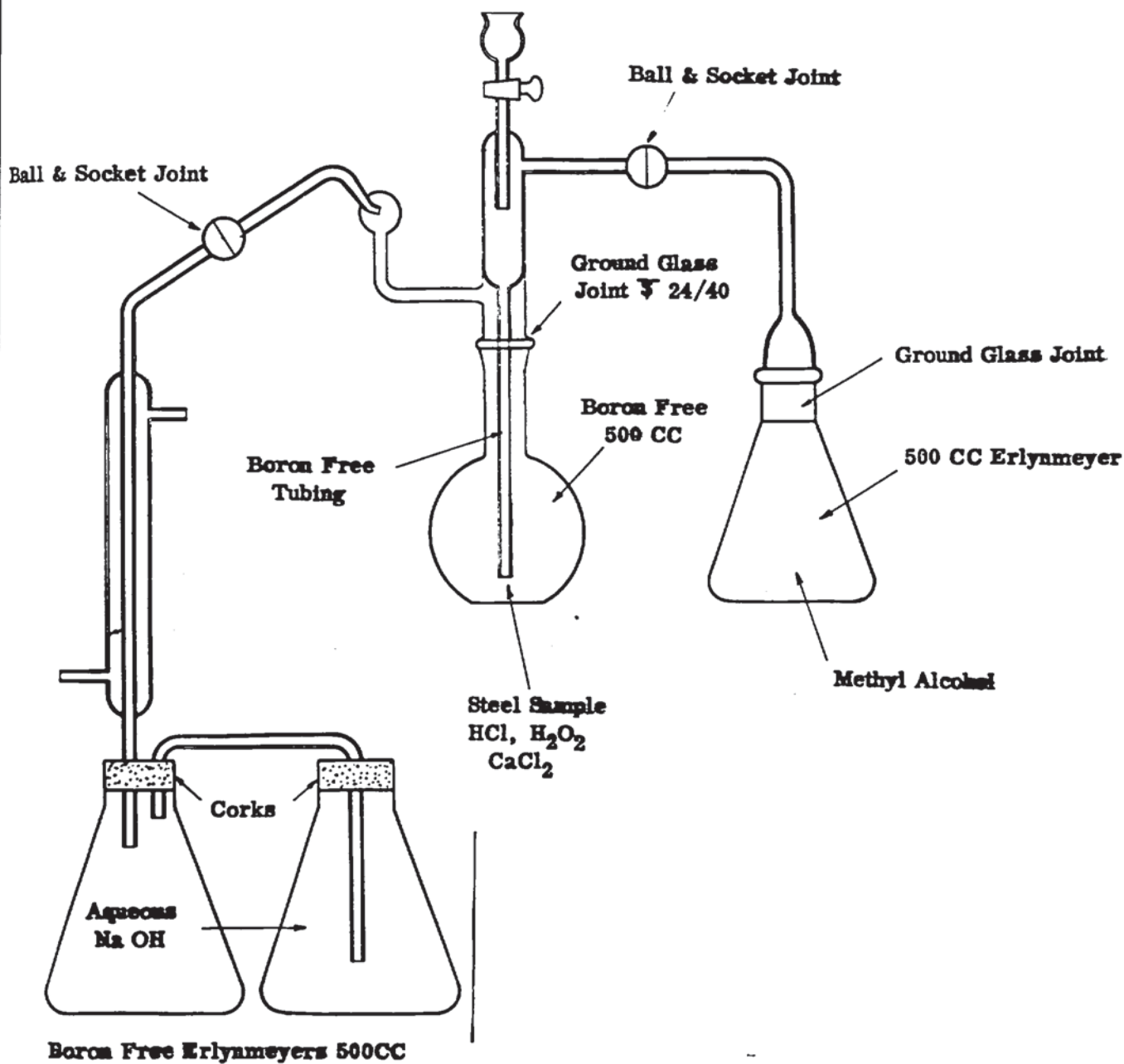

Figure 11 - Apparatus for Boron Determination

Sulphuric Acid 98.5%

To 1200 ccs of H_2SO_4 add 600 ccs fuming H_2SO_4 .
Mix well and allow to cool.

Quinalizarin Solution

Dissolve 0.01 gm in 100 ccs of strong H_2SO_4 made by slowly adding 9 vols. of 98.5% H_2SO_4 to 1 vol. of water.

Standard Boric Acid

Dissolve 2.8578 gms of boric acid in 1000 ccs H_2O .
1 cc contains 0.5 gm B. This is stock solution.

- (1) Take 20 ccs of stock and dilute to one litre.
One cc contains 0.01 mg B.
- (2) 100 ccs of (1) diluted to 1 litre.
One cc contains 0.001 mg B.

No.	<u>Boron present in colour standard</u>	<u>Distilled water</u>	<u>Boron stock solution</u>	<u>Represented % boron in sample using aliq.</u>
1	0.0000 mgs	2.00 ccs	0.00 ccs	Nil
2	0.0010	1.00	1.00 (2)*	0.0005
3	0.0020	0.00	2.00 (2)*	0.0010
4	0.0030	1.70	0.30 (1)*	0.0015
5	0.0040	1.60	0.40 (1)*	0.0020
6	0.0050	1.50	0.50 (1)*	0.0025
7	0.0060	1.40	0.60 (1)*	0.0030

Measure these standards into dry comparison bottles.
Slowly add 20 ccs of 98.5% H_2SO_4 and stopper. When cool
add 1.0 cc quinalizarin solution. Gently mix solutions by
swirling and stopper tightly. After 15 minutes the colours
become fully developed and are ready for use. They are
permanent if kept stoppered.

(The above are for the insoluble portion)

* Numbers in brackets refer to stock solutions.

Standards for the Soluble Portion

One gram portions of Bureau of Standards sample 55A or other boron free steel are weighed into 7 dry marked tubes and treated as follows:

<u>No.</u>	<u>Boron present in 1 gm sample</u>	<u>Conc. H₂SO₄</u>	<u>Boron stock solution</u>	<u>Dist. H₂O</u>	<u>Represents % boron in 2.0 cc aliq.</u>
1	0.0000 mg	1.5	0.00	6.50 cc	Nil
2	0.0050	1.5	5.00 (2)*	1.50	0.0005
3	0.0100	1.5	1.00 (1)*	5.50	0.0010
4	0.0150	1.5	1.50 (1)*	5.00	0.0015
5	0.0200	1.5	2.00 (1)*	4.50	0.0020
6	0.0250	1.5	2.50 (1)*	4.00	0.0025
7	0.0300	1.5	3.00 (1)*	3.50	0.0030

The standards in this table are completed as described in analytical procedure.

* Numbers in brackets refer to stock solutions.

Photoelectric (0.008%)

Weigh 2 gms sample into a boron free 500 cc round bottom flask. Connect to system (Figure 10). Add 30 ccs HCl. Heat gently to get in solution. When action ceases, cool to room temperature. Add very slowly 6 ccs Superoxol. Cool to room temperature and add 20 gms anhydrous calcium chloride.*

Soluble Boron

Distil off boron with anhydrous methyl alcohol. Distil over 200 ccs into receiver containing about 5 gms NaOH in each receiver. Rinse distillate into a 600 cc boron free beaker. Evaporate in steam bath to 100 ccs. Neutralize with H₂SO₄ (1:3) and add 2 ccs in excess. Transfer to a 200 cc volumetric flask and make up to mark with H₂O. To a 2 cc aliquot add 10 ccs H₂SO₄. Mix and cool. Add 10 ccs carminic acid. Allow to stand 45 minutes and compare in suitable comparator. Setting for Coleman 595 mμ. Run blank using 2 ccs H₂O, 10 ccs H₂SO₄ and 10 ccs carminic acid.

Insoluble Boron

After distillation the sample is filtered through a 41H paper. Transfer the paper and contents to a nickel crucible. Add one gm Na₂CO₃

and ignite whole at 850°C for half an hour. Cool, add a pinch of Na₂O₂ (about 50 mgms) and replace in muffle for 5 minutes. Cool and leach with H₂SO₄ (1:3). Pass through resin column (amberlite 1R12OH). Collect in a 200 cc volumetric flask. Wash with H₂O and make up to mark.

Take 2 cc aliquot and add 10 ccs H₂SO₄. Mix and cool. Add 10 ccs carminic acid. Let stand 45 minutes and compare as above, using 2 cc H₂O blank.

To determine blank for method run a boron free steel through procedure.

* The anhydrous calcium chloride is purified by vacuum drying after washing with HCl and anhydrous methyl hydrate.

Carminic Acid

0.5 gm carminic acid dissolved in 1,000 ccs of H₂SO₄.

DETERMINATION OF NICKEL AND COPPER IN STEEL

Polarographic

Weigh 1 gm sample into a 250 cc beaker.

Add 10 ccs HCl and 5 ccs HNO₃. Boil and evaporate to dryness.

Add 3 ccs HCl and 25 ccs H₂O.

Boil until salts in solution.

Cool and transfer to 100 cc volumetric flask (volume about 50 ccs).

Add 5 ccs pyridine.

Add 2 ccs gelatine (0.2% solution).

Make up to mark with H₂O.

Shake well and allow to settle.

Transfer 10 ccs of supernatant liquor (use pipette) to polarographic cell.

Take polarogram.

Ni at - 0.78 V

Co at - 1.07 V

Standardize using standard steels.

USEFUL FACTORS

Fe value of KMnO_4	x	0.4541	=	Cr_2O_3 value
" " "	x	0.3105	=	Cr "
" " "	X	0.1968	=	Mn value (Bismuthate)
" " "	x	0.2984	=	Mn value (Volhard)
" " "	x	0.5021	=	CaO value
" " "	x	0.956	=	MoS_2 "
" " "	x	1.4329	=	TiO_2 "
" " "	x	1.0907	=	Sb "

1.4045 gms FeAmSO_4 = 0.2 gm Fe
 0.24 gm sodium oxalate = 0.2 gm Fe

Standardizing Hypo with KMnO_4 :

No. of ccs KMnO_4 taken x 1.23686 x Fe value KMnO_4

No. of ccs hypo required
 = Pb value of hypo
 Pb value of hypo x 0.9204 = Cu value
 Cu value of hypo x 1.0865 = Pb value

As value of iodine x 1.625 = Sb value
 As value of iodine x 1.583 = Sn.value
 If 1 cc of I = 0.00326 gm As
 Then 1 cc I = $0.00326 \times \frac{160}{375} \times 2.58$ gm pyrrhotite

Al_2O_3 x 0.52914 = Al. Al x 1.8899 = Al_2O_3
 AlPO_4 x 0.22116 = Al
 BaSO_4 x 0.1373 = S. BaSO_4 x 0.34299 = SO_3
 SO_3 x 1.7744 = Na_2SO_4 . S x 2.58 = $\text{Fe}_{11}\text{S}_{12}$ (pyrrhotite)

CO_2 x 0.2727 = C
 CaO x 2.428 = CaSO_4
 Cr x 1,4615 = Cr_2O_3

Fe x 1.2865 = FeO
 Fe x 2.1483 = FeS_2
 Fe x 1.43 = Fe_2O_3

Phospho-molybdate x 0.0163 = P
 " x 0.03784 = P_2O_5
 P x 2.28908 = P_2O_5
 $\text{Mg}_2\text{P}_2\text{O}_7$ x 0.36211 = MgO
 SiO_2 x 0.4676 = Si
 MoS_2 x 0.6 = Mo
 V x 1.78 = V_2O_5
 V_2O_5 x 0.5606 = V
 WO_3 x 0.79303 = W

Bibliography

Ferrous Analysis, Modern Practice and Theory, by E. C. Pigott.
Publisher: Chapman and Hall, 37 Essex St., W.C. 2, London,
England.

Metallurgical Analysis by means of the "Spekker Absorptiometer",
by F. W. Haywood, Ph.D. F.I.C. and A. A. R. Wood.
Publisher: Adam Hilger Ltd., 98 St. Pancras Way, Camden Town,
London, N. W. 1, England.

Analoid Methods of Analysis (restricted for users of analoids).
Publisher: Ridsdale and Co. Ltd., 234 Marton Road, Middlesborough,
England.

The Analytical Chemistry of Tantalum and Niobium, by Schoeller.
Publisher: Chapman and Hall, 37 Essex St., W.C. 2, London,
England.

Standard Methods of Analysis of Iron, Steel and Ferro Alloys.
Publisher: The United Steel Co's Ltd., Sheffield, England. (1951)

Sampling and Analysis of Carbon and Alloy Steels, by Chemists of
United States Steel Corporation.
Publisher: Reinhold, Publishing Corporation.

Chemical Analysis of Iron and Steel, by Lundell, Hoffman and Bright.
Publisher: John Wiley and Sons, Inc., New York.

Outlines of Methods of Chemical Analysis, by Lundell and Hoffman.
Publisher: John Wiley and Sons, Inc., New York.

Polarographic Analysis, Kolthoff and Lingane.
Publisher: Interscience, 215 Fourth Avenue, New York.